

SHURE[®]

LEGENDARY
PERFORMANCE™

SV Microphones

SV100

SV100C

SV100M

SV200



Printed in China

UNIDIRECTIONAL DYNAMIC MICROPHONES

General Description

This Shure microphone can be used for karaoke, sound reinforcement, and recording applications. Its wide frequency response, unidirectional pickup pattern, and high output make vocal performances sound clear and vibrant. It is also suitable for instrument pickup.

FEATURES

- Unidirectional (cardioid) pickup pattern to minimize feedback (howling)
- Durable metal construction
- Wide frequency response
- Neodymium magnet for high output
- On/Off switch

Connecting and Disconnecting the Microphone Cable

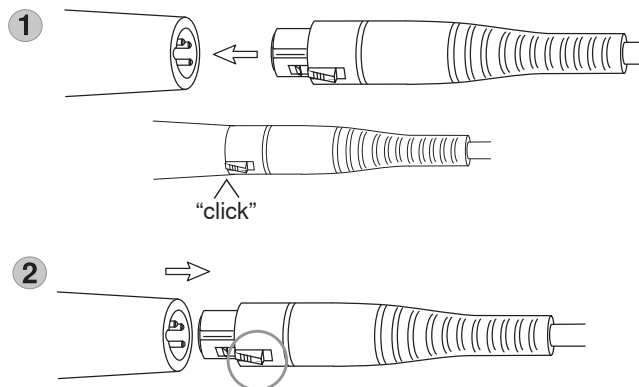

MICROPHONE USE

Turn on the microphone by sliding the switch to "ON". Turn off the microphone by sliding the switch to "OFF". Keep the switch in the "OFF" position while connecting or disconnecting the microphone from the karaoke machine, mixer or other device.

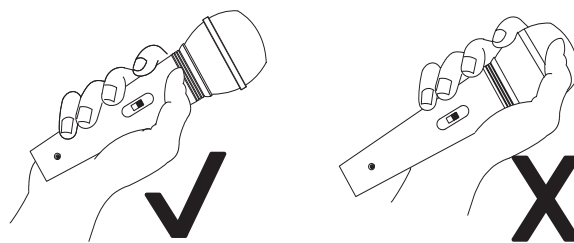

Do not cover grille with hand

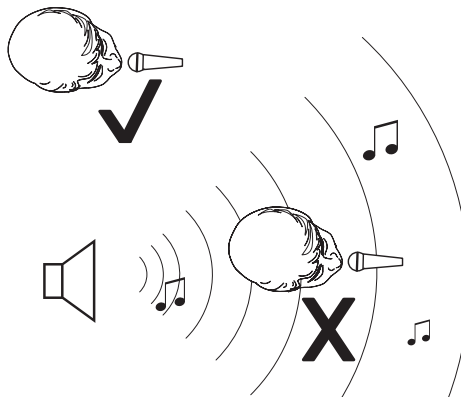

Avoiding Feedback (Howling)

SPECIFICATIONS

Type	Dynamic (moving coil)
Frequency Response	50 to 15,000Hz
Polar Pattern	Cardioid
Output Impedance	600 Ω
Sensitivity (at 1 kHz, open circuit voltage)	-52 dBV/Pa (2.5 mV) 1 Pascal=94 dB SPL
Weight	Net: 244 g (0.54 lb)
Connector	Three-pin professional audio (XLR), male

ACCESSORIES AND PARTS

Optional Accessories

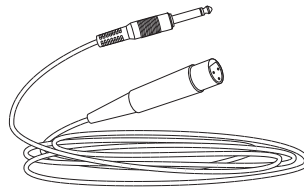

C15AHZ

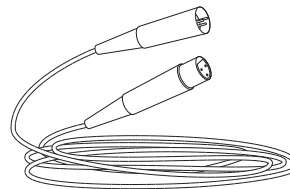

C25J



A25D

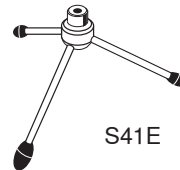

S41E

CERTIFICATION

Eligible to bear CE Marking. Conforms to European EMC Directive 2004/108/EC. Meets Harmonized Standards EN55103-1:1996 and EN55103-2:1996, for residential (E1) and light industrial (E2) environments.

The Declaration of Conformity can be obtained from:

Authorized European representative:
Shure Europe GmbH
Headquarters Europe, Middle East & Africa
Department: EMEA Approval
Wannenacker Str. 28
D-74078 Heilbronn, Germany
Phone: +49 7131 72 14 0
Fax: +49 7131 72 14 14
Email: EMEAsupport@shure.de

MICROPHONES ÉLECTRODYNAMIQUES UNIDIRECTIONNELS

Description générale

Ce microphone Shure peut être utilisé pour le karaoké, la sonorisation et les applications d'enregistrement. Grâce à une réponse en fréquence étendue, une configuration unidirectionnelle et un niveau de sortie élevé, il produit une voix claire et vibrante. Il convient également pour la prise de son d'instruments.

CARACTÉRISTIQUES

- Configuration unidirectionnelle (cardioïde) pour minimiser le Larsen (mugissement).
- Construction robuste en métal
- Réponse en fréquence à large bande
- Aimant au néodyme pour un niveau de sortie élevé
- Interrupteur marche/arrêt

Branchement et débranchement du câble du microphone

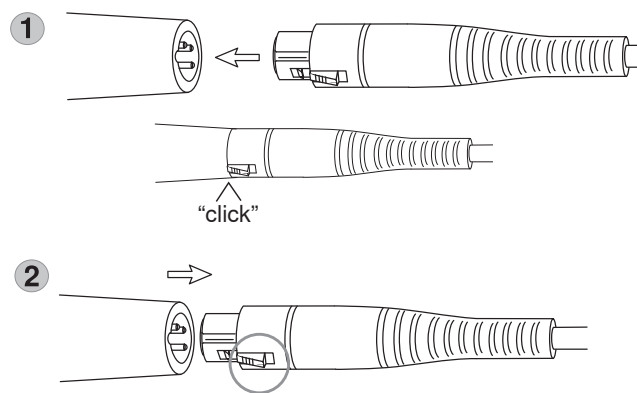

UTILISATION DU MICROPHONE

Mettre le microphone sous tension en glissant l'interrupteur sur "MARCHE".
Mettre le microphone hors tension en glissant l'interrupteur sur "ARRÊT".
Laisser l'interrupteur en position "ARRÊT" pendant le branchement (ou le débranchement) du microphone à la machine karaoké, au mélangeur ou à un autre appareil.

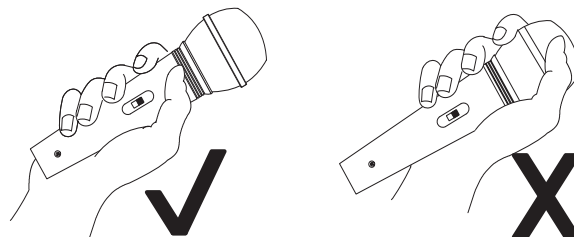

Ne pas couvrir la grille avec la main

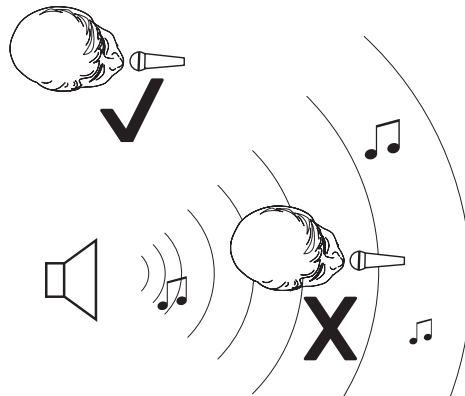

Éviter l'effet Larsen (mugissement)

Caractéristiques

Type	Dynamique (bobine mobile)
Réponse en fréquence	50 à 15.000Hz
Courbe de directivité	Cardioïde
Impédance de sortie	600 Ω
Sensibilité (à 1 kHz, tension en circuit ouvert)	-52 dBV/Pa (2,5 mV) 1 Pascal=94 dB NPA
Poids	Net: 244 g
Connecteur	Audio professionnel à trois broches (XLR), mâle

ACCESSOIRES ET PIÈCES

Accessoires en option

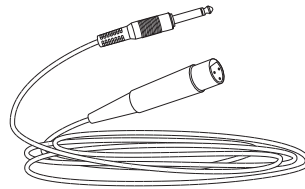

C15AHZ

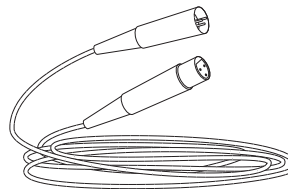

C25J



A25D

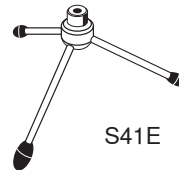

S41E

HOMOLOGATION

Autorisé à porter la marque CE. Conforme à la directive européenne CEM 2004/108/CE. Conforme aux normes harmonisées EN55103-1:1996 et EN55103-2:1996 pour les environnements résidentiels (E1) et d'industrie légère (E2).

La déclaration de conformité peut être obtenue de l'adresse suivante:

Représentant agréé européen :
Shure Europe GmbH
Siège Europe, Moyen-Orient et Afrique
Homologation EMEA
Wannenacker Str. 28
D-74078 Heilbronn, Germany
Phone: +49 7131 72 14 0
Fax: +49 7131 72 14 14
Email: EMEAsupport@shure.de

GERICHTETE DYNAMISCHE MIKROFONE

Allgemeine Beschreibung

Dieses Shure Mikrofon kann für Karaoke, Beschallungsanlagen und Aufzeichnungsanwendungen verwendet werden. Aufgrund seines breiten Frequenzgangs, der Nierenrichtcharakteristik und der hohen Ausgangsleistung klingen Gesangspräsentationen transparent und dynamisch. Es eignet sich auch für die Abnahme von Instrumenten.

TECHNISCHE EIGENSCHAFTEN

- Nierenförmige Richtcharakteristik zur Minimierung von Rückkopplungen
- Robuste Metallkonstruktion
- Weiter Frequenzgang
- Neodym-Magnet für hohe Ausgangsleistung
- An/Aus-Schalter

Anschließen und Abnehmen des Mikrofonkabels

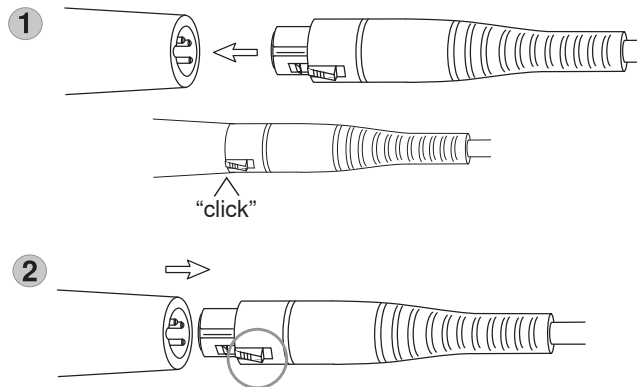

VERWENDUNG DES MIKROFONS

Das Mikrofon anschalten, indem der Schalter in die Stellung „ON“ geschaltet wird. Das Mikrofon ausschalten, indem der Schalter in die Stellung „OFF“ geschaltet wird. Den Schalter in der Stellung „OFF“ lassen, während das Mikrofon an ein Karaoke-Gerät, ein Mischpult oder ein anderes Gerät angeschlossen oder davon abgenommen wird.

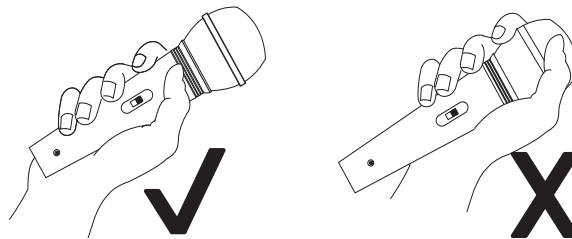

Den Grill nicht mit der Hand verdecken.

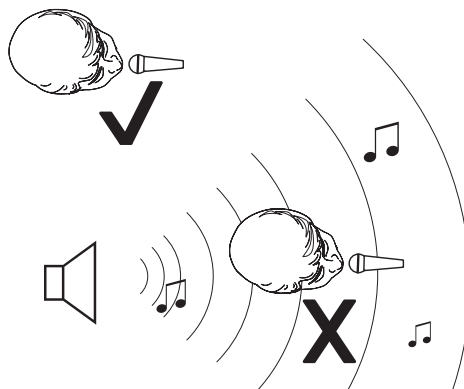

Vermeidung von Rückkopplung (Heulen)

TECHNISCHE DATEN

Typ	Dynamisch (Tauchspule)
Übertragungsbereich	50 bis 15.000Hz
Richtcharakteristik	Niere
Ausgangsimpedanz	600 Ω
Empfindlichkeit (bei 1 kHz, Leerlaufspannung)	-52 dBV/Pa (2,5 mV) 1 Pascal=94 dB Schalldruckpegel
Gewicht	Netto: 244 g
Stecker	Dreipoliger (XLR) Profi-Audiostecker

ZUBEHÖRTEILE

Sonderzubehör

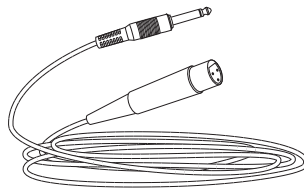

C15AHZ

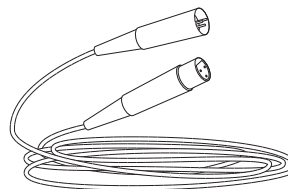

C25J



A25D

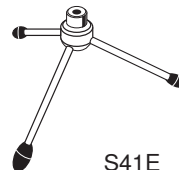

S41E

ZERTIFIZIERUNG

Zur CE-Kennzeichnung berechtigt. Entspricht der europäischen Richtlinie zur elektromagnetischen Verträglichkeit 2004/108/EG. Entspricht den Anforderungen der harmonisierten Normen EN55103-1:1996 und EN55103-2:1996 für Wohngebiete (E1) und Leichtindustrialgebiete (E2).

Die Konformitätserklärung ist über die unten stehende Adresse erhältlich:

Bevollmächtigter Vertreter in Europa:
Shure Europe GmbH
Headquarters Europe, Middle East & Africa
Abteilung: EMEA-Zulassung
Wannenacker Str. 28
D-74078 Heilbronn, Germany
Tel: +49 7131 72 14 0
Fax: +49 7131 72 14 14
Email: EMEAsupport@shure.de

MICROFONI DINAMICI UNIDIREZIONALI

Descrizione generale

Questo microfono Shure può essere utilizzato per applicazioni di karaoke, impianti di amplificazione sonora e registrazione. Grazie all'ampia risposta in frequenza, al diagramma di ricezione unidirezionale ed all'alto livello di uscita, le performance vocali risulteranno chiare e vibranti. Inoltre, può essere utilizzato per la ripresa di strumenti.

CARATTERISTICHE

- Diagramma (a cardioide) unidirezionale per ridurre al minimo il feedback (suoni acuti).
- Struttura metallica durevole.
- Risposta in frequenza ampia.
- Magnete al neodimio per un'uscita elevata.
- Interruttore generale (On-Off).

Collegamento e scollegamento del cavo del microfono

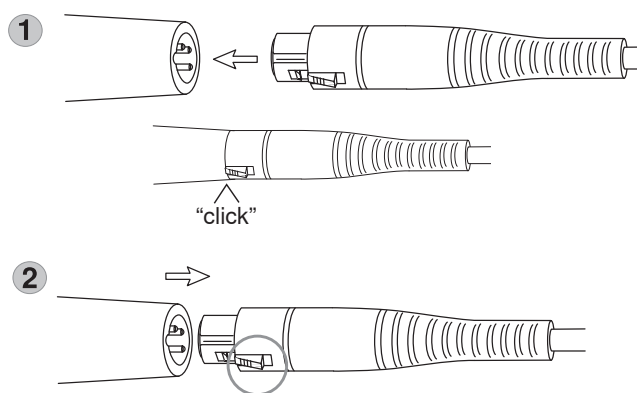

USO DEL MICROFONO

Per accendere il microfono, portate l'interruttore su ON. Per spegnere il microfono, portate l'interruttore su OFF. Tenete l'interruttore in posizione OFF durante il collegamento o il distacco del microfono da un impianto karaoke, mixer o altro dispositivo.

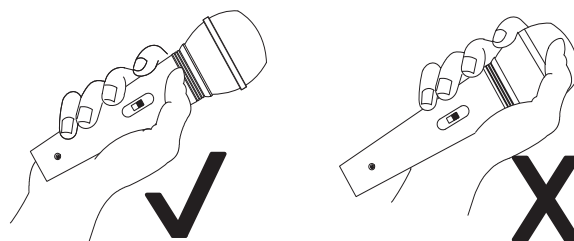

Non coprite la griglia con la mano

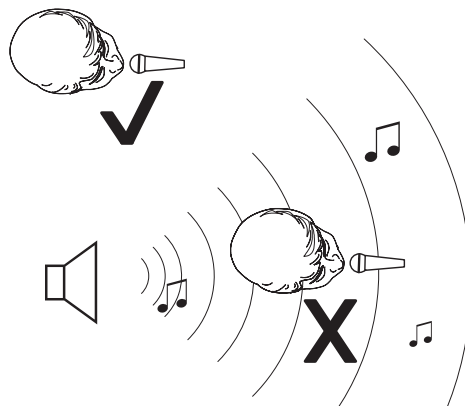

Come prevenire il feedback (suoni acuti)

SPECIFICHE TECNICHE

Tipo	Dinamico (a bobina mobile)
Risposta in frequenza	50 a 15.000Hz
Diagramma polare	Cardioide
Impedenza di uscita	600 Ω
Sensibilità (a 1 kHz, tensione a circuito aperto)	-52 dBV/Pa (2,5 mV) 1 Pascal=94 dB di SPL
Peso	Netto: 244 g (0,54 lb)
Connettore	Tipo audio, professionale, a tre piedini (XLR), maschio

ACCESSORI E PARTI DI RICAMBIO

Accessori opzionali

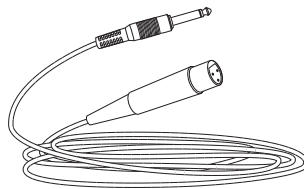

C15AHZ

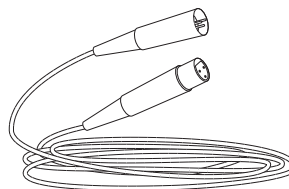

C25J



A25D

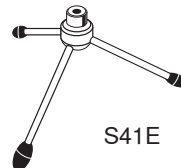
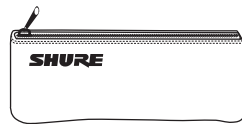

S41E

OMOLOGAZIONI

Contrassegnabile con il marchio CE. Conforme alla direttiva europea sulla compatibilità elettromagnetica 2004/108/CE. Conforme alle norme armonizzate EN55103-1:1996 ed EN55103-2:1996 per l'uso in ambienti domestici (E1) e industriali leggeri (E2).

La dichiarazione di conformità può essere ottenuta da:

Rappresentante europeo autorizzato:
Shure Europe GmbH
Sede per Europa, Medio Oriente e Africa
Approvazione EMEA
Wannenacker Str. 28
D-74078 Heilbronn, Germany
Phone: +49 7131 72 14 0
Fax: +49 7131 72 14 14
Email: EMEAsupport@shure.de

MICROFONOS DINAMICOS UNIDIRECCIONALES

Descripción general

Este micrófono Shure se puede utilizar para aplicaciones de karaoke, refuerzo de sonido y grabación. Su respuesta de frecuencia amplia, patrón de captación unidireccional y alto nivel de señal de salida reproducen a los vocalistas de modo claro y vibrante. También es adecuado para captar instrumentos.

CARACTERISTICAS

- Patrón de captación unidireccional (cardioide) para reducir al mínimo la realimentación de sonido (chillidos)
- Fabricación de metal duradero
- Respuesta de frecuencias amplia
- Imán de neodimio para una señal de salida más intensa
- Interruptor de encendido

Conexión y desconexión del cable del micrófono

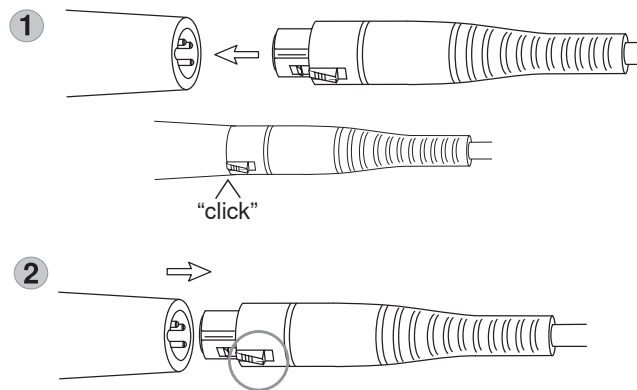

USO DEL MICROFONO

Para encender el micrófono, deslice su interruptor a la posición "ON". Para apagar el micrófono, deslice su interruptor a la posición "OFF". Mantenga el interruptor en la posición "OFF" mientras conecta o desconecta el micrófono de una máquina de karaoke, consola mezcladora u otro dispositivo.

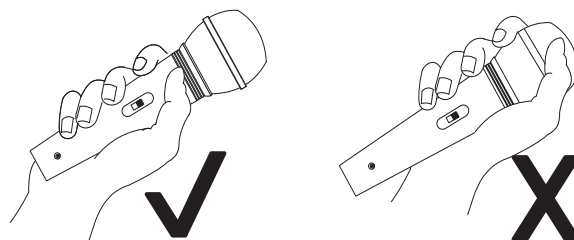

No cubra la rejilla con la mano

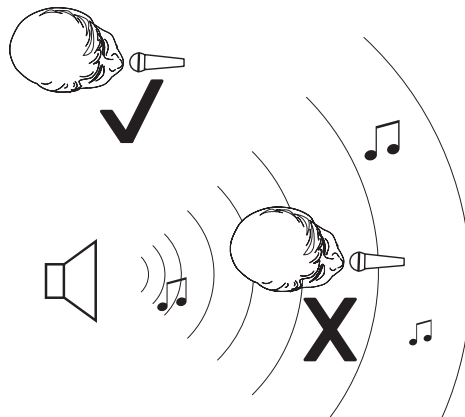

Evite la realimentación de sonido (chillidos)

ESPECIFICACIONES

Tipo	Dinámico (bobina móvil)
Respuesta de frecuencia	50 a 15.000Hz
Patrón polar	Cardioide
Impedancia de salida	600 Ω
Sensibilidad (a 1 kHz, voltaje en circuito abierto)	-52 dBV/Pa (2,5 mV) 1 Pascal=94 dB SPL
Peso	Neto: 244 g (0,54 lb)
Conector	Conector de audio de tres clavijas profesional (tipo XLR), macho

ACCESORIOS Y PIEZAS

Accesorios opcionales

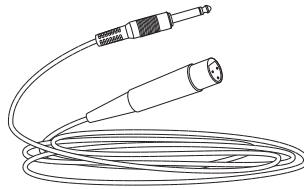

C15AHZ

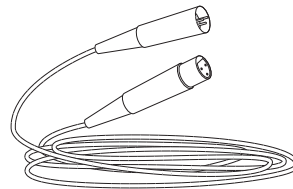

C25J



A25D

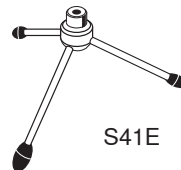
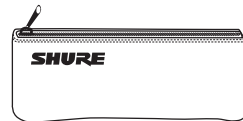

S41E

CERTIFICACIONES

Califica para llevar la marca CE. Cumple con la directiva europea de EMC 2004/108/EC. Satisface las normas armonizadas EN55103-1:1996 y EN55103-2:1996 para entornos de uso residencial (E1) e industrial ligero (E2).

La declaración de conformidad se puede obtener de la siguiente dirección:

Representante autorizado en Europa:
Shure Europe GmbH
Casa matriz para Europa, Medio Oriente y Africa
Aprobación para región de EMEA
Wannenacker Str. 28
D-74078 Heilbronn, Germany
Phone: +49 7131 72 14 0
Fax: +49 7131 72 14 14
Email: EMEAsupport@shure.de

ОДНОНАПРАВЛЕННЫЕ ДИНАМИЧЕСКИЕ МИКРОФОНЫ

Общее описание

Этот микрофон Shure может использоваться для караоке, усиления звука и записи. Благодаря его широкой частотной характеристике, однонаправленной диаграмме приема и высокой мощности вокальные выступления звучат четко и живо. Его также можно использовать для приема инструментальной музыки.

Особенности

- Однонаправленная (кардиоидная) диаграмма приема для сведения к минимуму обратной связи (воя)
- Прочная металлическая конструкция
- Широкая частотная характеристика
- Неодимовый магнит обеспечивает высокую выходную мощность
- Выключатель

Подсоединение и отсоединение кабеля микрофона

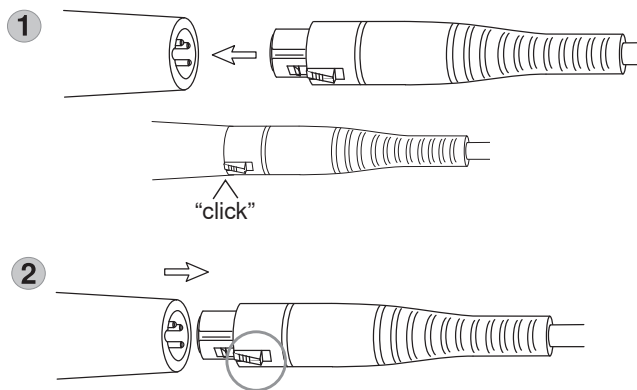

ИСПОЛЬЗОВАНИЕ МИКРОФОНА

Включайте микрофон, сдвигая переключатель в положение ON (ВКЛ.). Выключайте микрофон, сдвигая переключатель в положение OFF (ВЫКЛ.). При подсоединении или отсоединении микрофона от аппаратуры караоке, микшера или другого устройства переключатель должен оставаться в положении OFF (ВЫКЛ.).

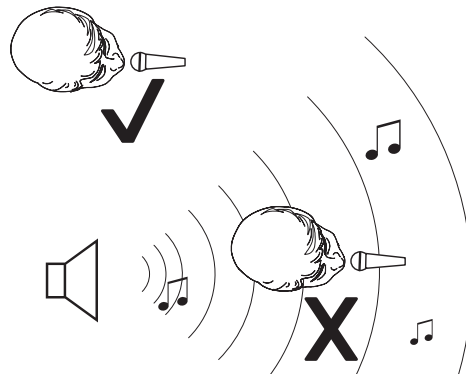

Избежание обратной связи (воя)

Технические характеристики

Тип	Динамический (с подвижной катушкой)
Амплитудно-частотная характеристика	50 до 15 000 Гц
Диаграмма направленности	Кардиоидная
Выходной импеданс	600 Ω
Чувствительность (при 1 кГц, напряжение разомкнутой цепи)	-52 дБВ/Па (2.5 мВ) 1 паскаль = УЗД 94 дБ
Масса	Нетто: 244 г (0.54 lbs)
Разъем	Трехконтактный штекерный для профессиональной аудиоаппаратуры (XLR)

ПРИНАДЛЕЖНОСТИ И СМЕННЫЕ ДЕТАЛИ

Отдельно заказываемые принадлежности

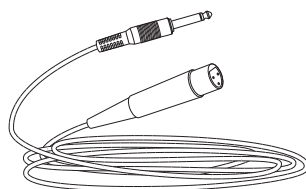

C15AHZ

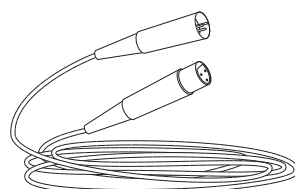

C25J



A25D

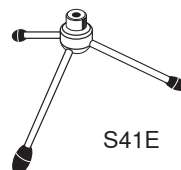

S41E

СЕРТИФИКАЦИЯ

Соответствует требованиям для нанесения маркировки CE.
Соответствует требованиям европейской директивы 2004/108/ЕЕС по ЭМС. Соответствует требованиям гармонизированных стандартов EN55103-1:1996 и EN55103-2:1996 для жилых районов (E1) и районов с легкими промышленными условиями (E2).

Заявление о соответствии можно получить по следующему адресу:

Уполномоченный европейский представитель:
Shure Europe GmbH
Headquarters Europe, Middle East & Africa
Department: EMEA Approval
Wannenacker Str. 28
D-74078 Heilbronn, Germany (Германия)
Телефон: +49 7131 72 14 0
Факс: +49 7131 72 14 14
Эл. почта: EMEAsupport@shure.de

ダイナミック型マイクロホン/単一指向性

概要

このShureマイクロホンは、カラオケ、拡声、録音用途に使用することができます。幅広い周波数特性、単一指向特性、高出力により、クリアで鮮明なボーカルパフォーマンスサウンドを得ることができます。また、楽器の收音にも最適です。

機能

- 単一指向性（カーディオイド）特性によりフィードバック（ハウリング）を抑制
- 頑丈な金属製ボディ
- 広域周波数特性
- 高出力用のネオジウムマグネット
- ON-OFFスイッチ

マイクロホンケーブルの接続及び取り外し

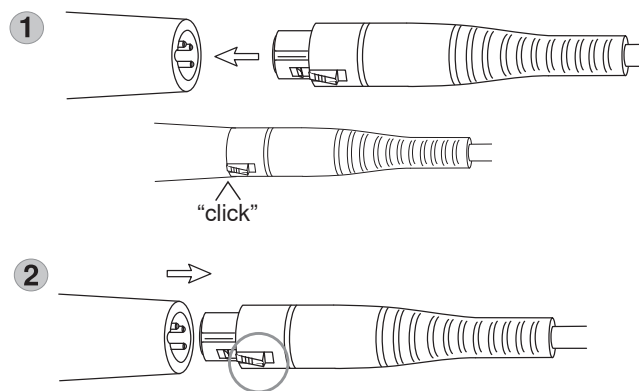

マイクロホンの使い方

スイッチを「ON」の位置にスライドさせてマイクロホンをオンにします。スイッチを「OFF」の位置にスライドさせてマイクロホンをオフにします。マイクロホンをカラオケ装置やミキサー、またはその他の機器に接続したり取外したりする際は、スイッチは「OFF」の位置にしておいてください。

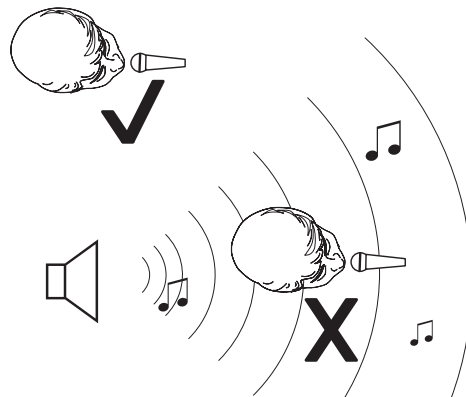
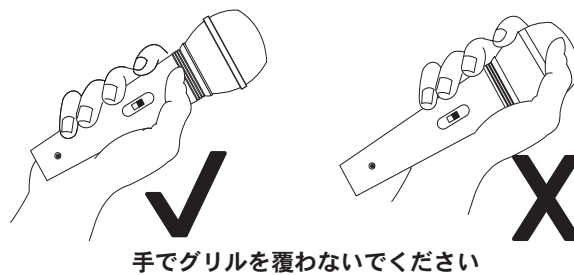

仕様

型	ダイナミック型 (ムービングコイル方式)
周波数特性	50 ~ 15,000Hz
指向特性	カーディオイド
出カインピーダンス	600 Ω
感度 (1 kHz、開回路電圧)	-52 dBV/Pa (2.5 mV) 1パスカル=94 dB SPL
質量	本体: 244 g
コネクター	プロオーディオ用3ピン (XLR)、オス

アクセサリおよびパーツ オプション・アクセサリ (別売)

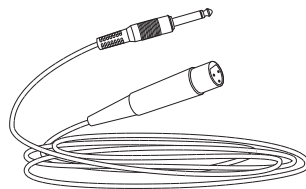

C15AHZ

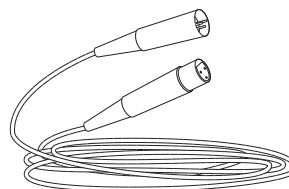

C25J



A25D

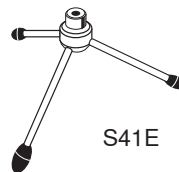

S41E

認証

CEマーキングに適合。欧州EMC指令2004/108/ECに適合。住宅(E1)および軽工業(E2)環境に関し、EN55103-1:1996およびEN55103-2:1996の整合規格に対応。

適合宣言書は以下より入手可能です:

ヨーロッパ認定代理店:
Shure Europe GmbH
ヨーロッパ、中東、アフリカ地区本部:
部門: EMEA承認
Wannenacker Str. 28
D-74078 Heilbronn, Germany
Phone: +49 7131 72 14 0
Fax: +49 7131 72 14 14
Eメール: EMEAsupport@shure.de

单指向动圈话筒

产品概述

可以将此 Shure 话筒用于卡拉 OK、扩声和录音。它的宽频响应、单指向性和高输出能够确保声音的清晰与嘹亮。它也适用于乐器拾音。

特性

- 单向（心形）拾音方式可将反馈（啸叫音）降低到最低水平
- 坚固耐用的金属结构
- 更宽的频率响应
- 高输出钹磁铁
- 电源开关

话筒线的连接与断开

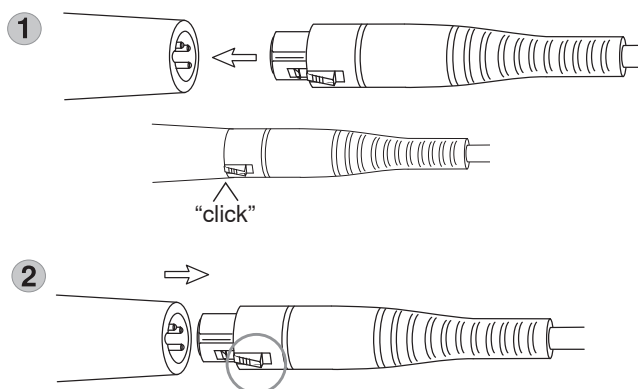

话筒使用

将开关滑动到“ON（打开）”位置，可打开话筒。将开关滑动到“OFF（关闭）”位置，可关闭话筒。在从卡拉 OK 机、混音器或其它装置上连接或断开话筒时，应将开关置于“OFF（关闭）”位置。

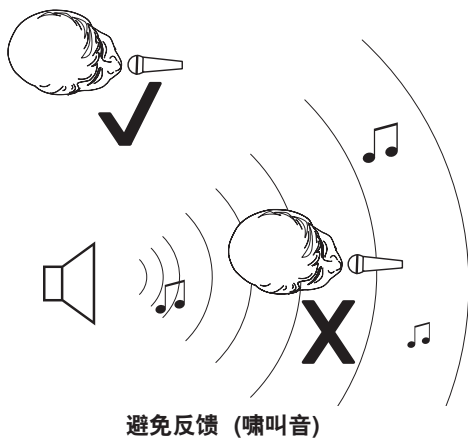

规格

类型	动圈
频率响应	50 至 15,000Hz
指向性图样	心形
输出阻抗	600 Ω
灵敏度 (1 kHz 时, 开路电压)	-52 dBV/Pa (2.5 mV) 1 Pa=94 dB SPL
重量	净重: 244 克 (0.54 lbs)
接头	三针卡侬公头 (XLR)

附件和替换备件

可选配附件

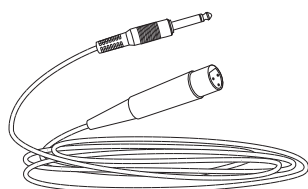

C15AHZ

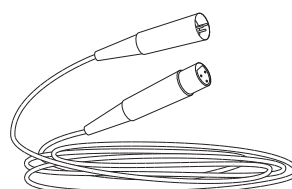

C25J



A25D

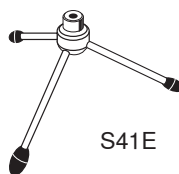

S41E

认证

允许使用 CE 标志。符合欧盟 EMC 法规 2004/108/EC。符合 Harmonized 标准 EN55103-1 : 1996 和 EN55103-2 : 1996 适用于民用 (E1) 和轻工业 (E2) 环境。

可从以下地址获得“符合性声明”：

欧洲授权代表：
Shure Europe GmbH
Headquarters Europe, Middle East & Africa
Department: EMEA Approval
Wannenacker Str. 28
D-74078 Heilbronn, Germany
电话：+49 7131 72 14 0
传真：+49 7131 72 14 14
电子邮件：EMEAsupport@shure.de

단일지향성 다이내믹 마이크

일반 설명

이 Shure 마이크는 노래방, 음향 강화와 레코딩 환경에 사용될 수 있습니다. 넓은 주파수 응답, 단일 지향성 픽업 패턴 및 고출력은 보컬 사운드를 명료하고 활력있게 만들어줍니다. 또한 악기 픽업에도 적합합니다.

특징

- 피드백 (하울링)을 최소화하는 단일지향성 (카디오이드) 픽업 패턴
- 내구성 있는 금속 구조
- 넓은 주파수 응답
- 고출력을 위한 네오디뮴 자석
- 온/오프 스위치

마이크 케이블 연결과 해제

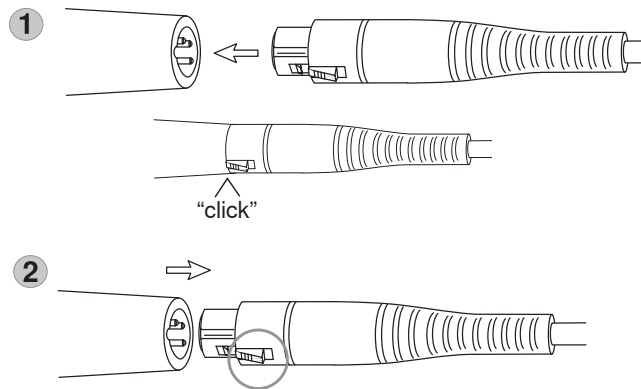

마이크 사용

스위치를 "ON"으로 밀어서 마이크를 켭니다. 스위치를 "OFF"으로 밀어서 마이크를 끕니다. 마이크를 노래방, 기계, 믹서 또는 기타 장치에 연결하거나 분리하는 동안 스위치를 "OFF"에 놓으십시오.

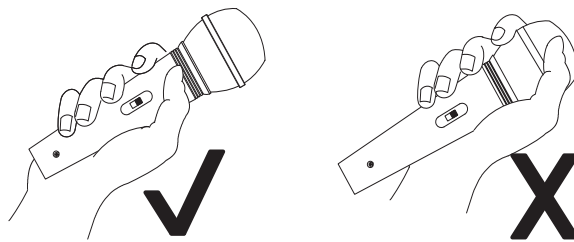

그릴을 손으로 덮지 마십시오.

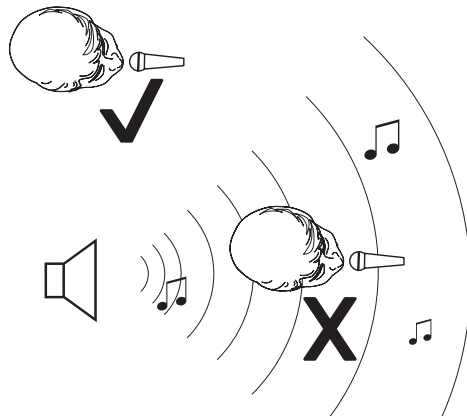

피드백 (하울링) 회피

사양

형식	다이내믹 (무빙 코일)
주파수 응답	50 ~ 15,000Hz
극성 패턴	단일지향성
출력 임피던스	600 Ω
감도 (1 kHz에서, 개방 회로 전압)	-52 dBV/Pa (2.5 mV) 1 Pascal=94 dB SPL
무게	순: 244 g (0.54 lbs)
커넥터	3핀 전문 오디오 (XLR), 수(♂)

부품

액세서리 선택 사양

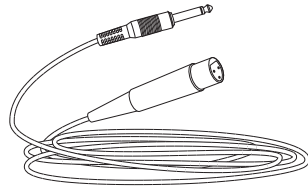

C15AHZ

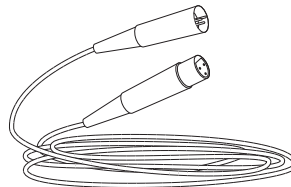

C25J



A25D

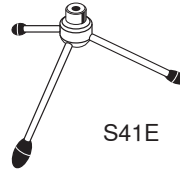

S41E

인증

CE 마크를 사용할 자격이 있습니다. European EMC Directive 2004/108/EC를 준수합니다. 가정용 (E1) 및 경공업용 (E2) 통일 규격 (Harmonized Standards) EN55103-1:1996 및 EN55103-2:1996 요건들을 준수합니다.

적합성 선언서를 구하실 수 있는 곳:

공인 유럽 대리점:
Shure Europe GmbH
유럽, 중동, 아프리카 본부
부서: EMEA(유럽중동) 승인
Wannenacker Str. 28
D-74078 Heilbronn, Germany
전화: +49 7131 72 14 0
팩스: +49 7131 72 14 14
이메일: EMEAsupport@shure.de

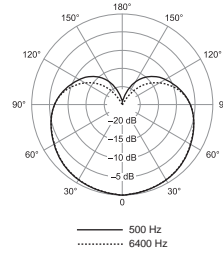
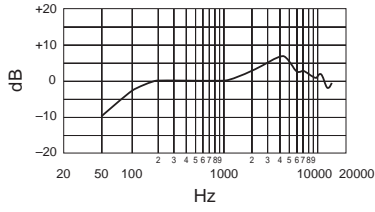
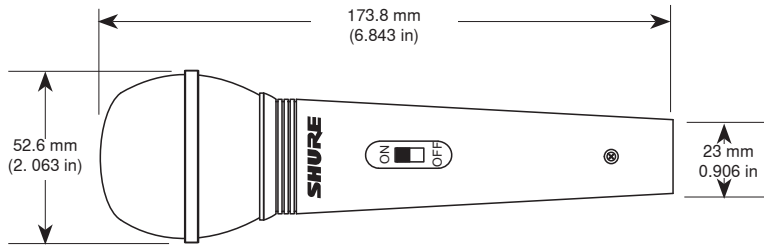

SHURE®