

# Digital Drum

---

## Owner's Manual

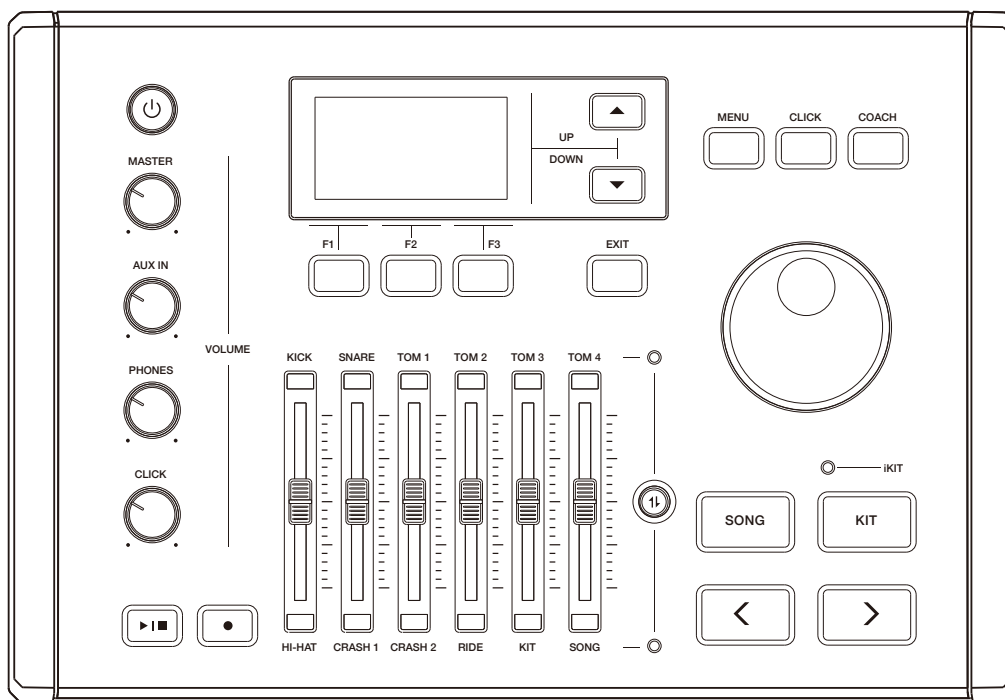

# INFORMATION FOR YOUR SAFETY!

## PRECAUTIONS

### CAUTION

The normal function of the product may be disturbed by Strong Electro Magnetic Interference. If so, simply reset the product to resume normal operation by following the owner's manual. In case the function could not resume, please use the product in other location.

### Packing List

Thank you for purchasing this instrument. Please check all the items listed below are included in the package.

- Drum Module (x1)
- Drum Pad (x4)
- Cymbal Pad (x3)
- Kick (Pad + Pedal) (x1 set)
- Pedal (Hi-hat) (x1)
- Drum Stand (x1 set)
- Connection Cable (x1 set)
- Drumsticks (x1 set)
- AC Adaptor (x1)
- Owner's Manual (x1 set, Chinese and English)
- Setup Manual (x1 set, Chinese and English)
- Warranty (x1)

### Assembling

Never attempt to disassemble or modify any components of the instrument; doing so may result in electric shock, fire, physical injury or malfunction.

Never sit or stand on the Drum Stand, doing so may cause the stand falling over or being damaged, and consequently might lead to physical injury.

Special caution should be paid when come into contact with screws used to affix Kick Pad and Pedal (Hi-hat), as the sharp point of these screws may cause physical injury.

Securely tighten all clamps, bolts and screws. Make sure to firmly tighten any nut that is loose. Any loose connection may result in drum pad and/or drum stand falling over, and consequently might lead to physical injury.

Carefully place the connection cable to avoid injury to anyone who may be tripped over.

### PLEASE READ CAREFULLY BEFORE PROCEEDING

Please keep this manual in a safe place for future reference.

#### Power Supply

Please connect the designated AC adaptor to an AC outlet of the correct voltage.

Do not connect it to an AC outlet of voltage other than that for which your instrument is intended.

Unplug the AC power adaptor when not using the instrument, or during electrical storms.

#### Connections

Before connecting the instrument to other devices, turn off the power to all units. This will help prevent malfunction and / or damage to other devices.

#### Location

Do not expose the instrument to the following conditions to avoid deformation, discoloration, or more serious damage:

- Direct sunlight
- Extreme temperature or humidity
- Excessive dusty or dirty location
- Strong vibrations or shocks
- Close to magnetic fields

#### Interference with other electrical devices

Radios and televisions placed nearby may experience reception interference. Operate this unit at a suitable distance from radios and televisions.

#### Cleaning

Clean only with a soft, dry cloth. Do not use paint thinners, solvents, cleaning fluids, or chemical-impregnated wiping cloths.

#### Handling

Do not apply excessive force to the switches or controls.

Do not let paper, metallic, or other objects into the instrument. If this happens, remove the electric plug from the outlet. Then have the instrument inspected by qualified service personnel.

Disconnect all cables before moving the instrument.

# Contents

<b>Main Features</b> .....	4	<b>Song</b>	
<b>Panel &amp; Display Description</b>		Playing Preset Songs.....	17
Front Panel.....	5	Playing Along with a Song.....	17
Rear Panel.....	6	<b>Recording</b>	
LCD Display.....	6	Prepare and Start Recording.....	18
<b>Setup</b>		Rename and Save MIDI Recording.....	18
Connecting the Pads and Pedals.....	7	<b>Coach</b>	
<b>Getting Ready to Play</b>		Quiet Count.....	19
Setting up the Power Supply.....	8	Beat Check.....	20
Turning on the Power.....	8	Change Up.....	20
Turning off the power.....	8	<b>Volume Sliders</b> .....	21
Restore Factory Settings.....	8	<b>Settings</b>	
<b>Quick Play</b>		Trigger Settings.....	22
Drum Kits and Voices.....	9	Master Compress.....	23
Selecting a Drum Kit.....	9	MIDI Setup.....	24
Selecting a Voice.....	9	Auto Power Off.....	24
Playing Techniques.....	9	Factory Reset.....	25
<b>Drum Kit</b>		<b>Specifications</b> .....	26
Preset, User and iKit Drum Kits.....	11	<b>Appendices</b>	
Selecting a Drum Kit.....	11	Drum Kit List.....	27
Editing Kit Parameters.....	12	iKit List.....	27
Editing Kit Effect.....	12	Drum Voice List.....	28
REVERB.....	13	Song List.....	32
EQ.....	14	GM Drum Kit List.....	33
Saving a User Kit.....	14	GM Backing Voice List.....	35
<b>Click</b>		MIDI Implementation Chart.....	36
Turning the Click on or off.....	16	Prompt Messages.....	37
Editing Click Parameters.....	16		

# Main Features



## PURE DRUM Technology

No matter playing the pads with soft stroke or forceful passion grooves, with this new technology, all performances can show up extremely wide range of velocity dynamics. Perfectly express the various changes of acoustic drums, all of these let you enjoy the real delicate nuances, capture the unique characteristics of acoustic drum kit from the PURE DRUM!

## PURE DRUM - Bringing Natural and Realistic Voices to Your Performance!

This unique PURE DRUM technology greatly improves sound quality for digital drums, bringing a more natural and realistic feel to your ears. No matter playing stroke roll or striking pads with velocity dynamics, all these will let you enjoy the delicate nuances and natural voice, capture the unique characteristics of acoustic drum kit.

## iKit – Playing with Super Delicate Sensitivity

This black technology makes digital drums reach a new height. The improved dynamics and sensitivity replicates every nuance of an acoustic drum and gives you a more natural feel of any subtle change in velocity dynamics.

## Superb Playing Experience

By utilizing specially-treated pad and cymbal surface and unique technology, it provides superb sensitivity and authentic touch but low playing noise, opening a new era for digital drums by replicating the diverse playing techniques of an acoustic drum kit, such as head, rim, bell, choke and so on.

## Steady and Elegant Look

The elegantly-designed module, equipped with a dot-matrix LCD and data dial for convenient operation, plus the finely-shaped drum stands, all these make it look steady, professional and classy.

# Panel & Display Description

## Front Panel

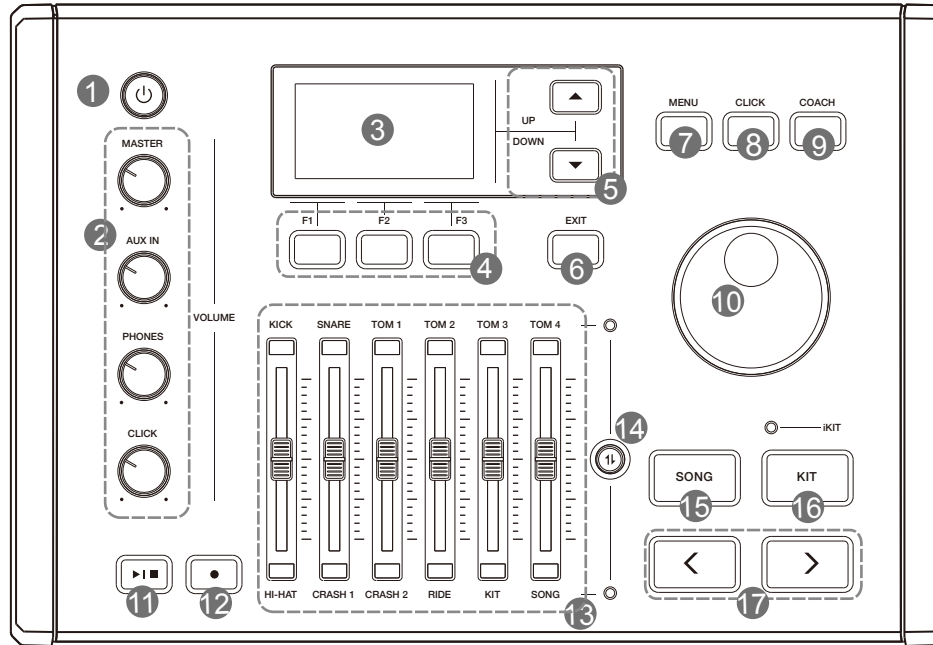

### 1. [POWER] Button

Turn the power on or off.

### 2. [MASTER] Knob

Adjust the output volume.

### [AUX IN] Knob

Adjust the audio input volume.

### [PHONES] Knob

Adjust the phones volume.

### [CLICK] Knob

Adjust the click volume.

### 3. LCD Display

Display the name and parameter settings of Kits, Voices and Songs etc.

### 4. [F1] ~ [F3] Buttons

Press to execute a related function shown on LCD.

### 5. [^]/[v] Buttons

Press to move the cursor to select a parameter on LCD.

### 6. [EXIT] Button

Press to return to previous menu.

### 7. [MENU] Button

**In kit mode:** press to enter KIT menu.

**In song mode:** press to enter SONG menu.

### 8. [CLICK] Button

Press to start/stop the click; edit the click setting.

### 9. [COACH] Button

Press to enter coach mode.

### 10. Data Dial

Rotate to adjust the selected parameter.

### 11. [▶|■] Button

Press to start/stop playing a song.

### 12. [•] Button

Press to enter record mode.

### 13. Volume Sliders

Adjust the related trigger volume, kit volume and song volume.

### 14. Volume Slider Control Button

Press to toggle between the upper and lower group of parameters.

### 15. [SONG] Button

Press to enter song mode.

### 16. [KIT] Button

Press to enter kit mode.

### 17. [<]/[>] Buttons

Press to select a drum kit or edit parameters (to increase/decrease the value).

# Panel & Display Description

## Rear Panel

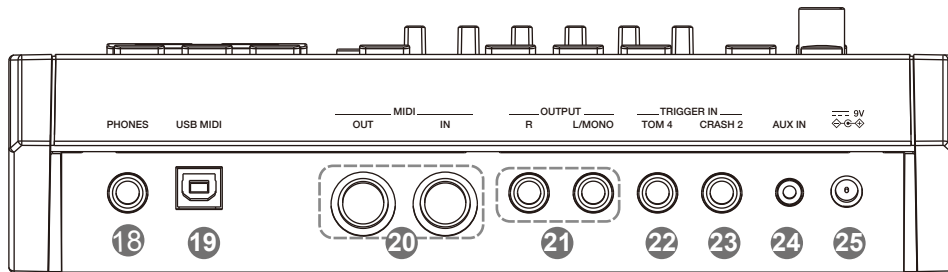

**18. PHONES jack (1/4")**

Connect a pair of stereo headphones to detect all output sounds.

**19. USB MIDI jack**

Connect to PC and transmit MIDI data.

**20. MIDI jacks (IN, OUT/THRU)**

Connect an external MIDI sequencer to receive or transmit MIDI data.

**21. OUTPUT jacks (L/MONO, R)(2 x1/4")**

Connect to an audio system or amplifier. Use the L/MONO and R jacks for stereo output or just the L/MONO jack for mono output.

**22. TOM 4 jack (1/4")**

Connect an additional Tom 4.

**23. CRASH 2 jack (1/4")**

Connect an additional Crash 2.

**24. AUX IN jack (1/8")**

Connect an external audio player, such as an MP3. Music from the external player will be transmitted to the module, and you can play along.

**25. DC IN jack**

Connect the specified power adaptor.

**26. TRIGGER INPUT jack**

Insert the dedicated trigger cables here, to connect the pads and pedals.



## LCD Display

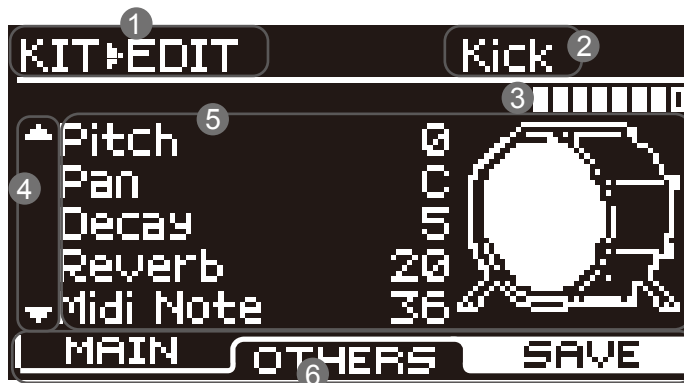

**1. Menu**

Display the current menu, such as "KIT", "SONG" and "COACH" etc.

**2. Trigger Pad Name**

Display the selected trigger pad name, such as "Kick", "Snare Head" and "Snare Rim" etc.

**3. Velocity of Pad Strike**

Display the velocity (force) at which the pad is struck.

**4. Prompt to Move Cursor Up/Down**

Prompt to press the [^]/[v] buttons to view more parameters.

**5. Detailed Parameters**

Display detailed parameter settings.

**6. [F1]/[F2]/[F3] Indicators**

Display functions of the [F1] ~ [F3] buttons.

**Caution!**

To prevent electric shock and damage to the device, make sure the power is switched OFF on the drum and all related device before making any connection.

**Connecting the Pads and the Pedals****Standard configuration:**

KICK, SNARE (dual-zone trigger), TOM 1~3 (dual-zone trigger), CRASH (dual-zone trigger with choke), RIDE (triple-zone trigger with choke), HI-HAT (dual-zone trigger), PEDAL(HI-HAT).

**Note:**

1. Use the cables provided to connect the pads to the trigger input jack on the rear panel of the module, make sure each pad is connected to its corresponding trigger input jack.
2. For details on assembling the drum stand, attaching the digital drum and connecting the pads, please refer to the **Setup manual** .

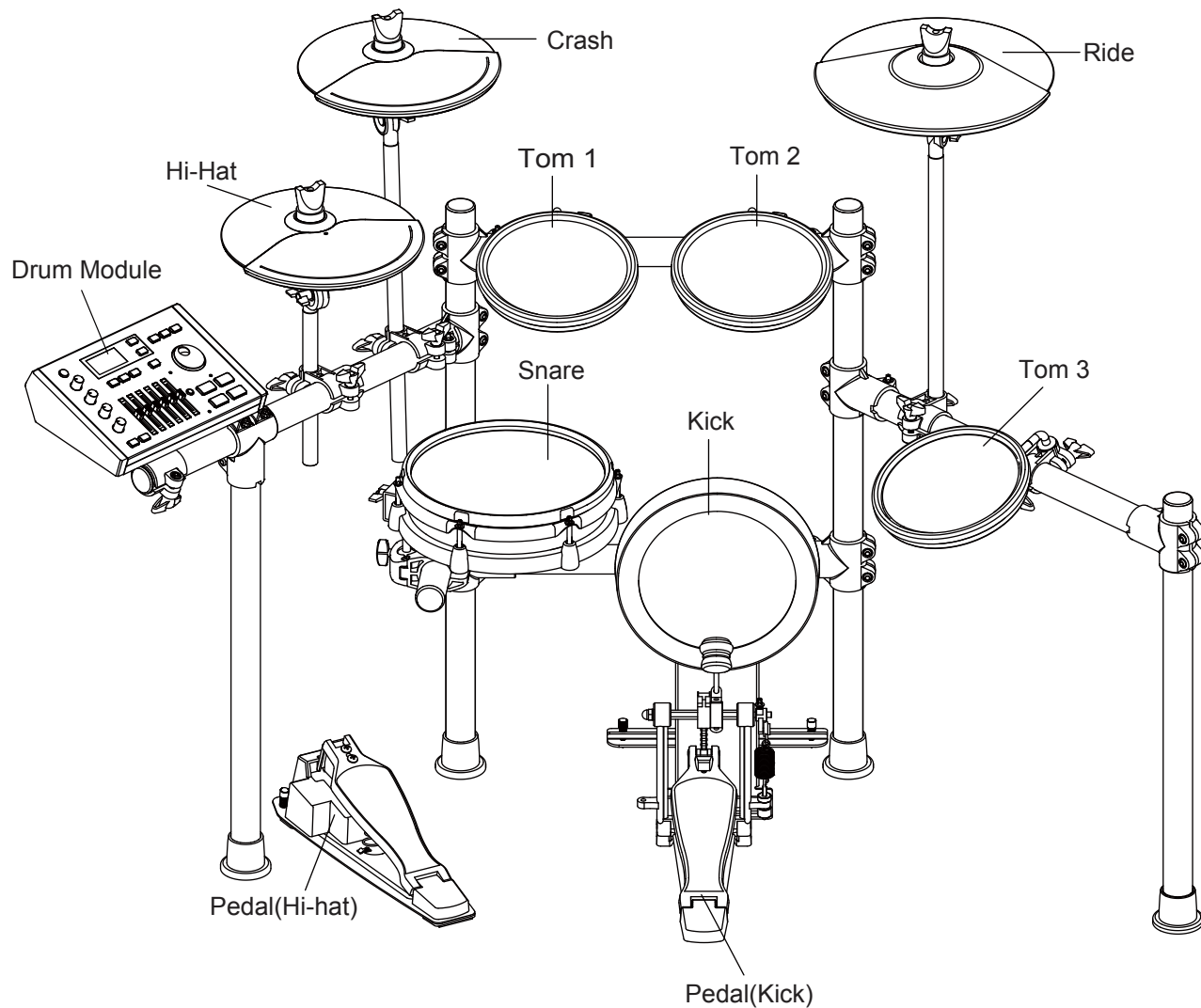

# Getting Ready to Play

## Setting up the Power Supply

1. Connect the power adaptor to the DC IN jack on the rear panel.
2. Plug the other end of the power cord to an appropriate AC outlet.

### Note:

1. Please use the specified power adaptor.
2. Even when the module is turned off, electricity is still flowing to the module at minimum level. Please unplug the module when it is not in use for a long time.

## Turning on the Power

Make sure you have completed all necessary connections (triggers, audio device and so on). Then turn the volume level of all the devices to minimum.

1. Turn all the volume knobs to minimum before turning on the power.
2. Press the [POWER] button, the display is lit, indicating the module is turned on.
3. Turn on the connected amplifier or audio device, or listen with headphones.
4. Adjust the [MASTER]/[PHONES] knobs clockwise while striking the pads, until you get an appropriate volume level.



## Turning off the power

1. Turn the volume level of the module and the connected audio device to minimum.
2. Turn off the connected device.
3. Press the [POWER] button until the display becomes unlit.

### Auto Power Off

In order to save energy, the module will automatically shut down after 30 minutes if it is not in use (playing, striking, button pressing, etc.) You can enable or disable this function as desired. Please refer to **Option**.

## Restore Factory Settings

Follow the operation below to reset the module to factory settings.

1. Press and hold [<] and [>] buttons, then press the [POWER] button to turn on the power.
2. The LCD will display "Factory Resetting...". When factory reset is finished, the display will return to KIT menu.  
The following parameters will restore factory settings: Trigger, MIDI Setup, Option, Master Compress, User Kits and User Songs.

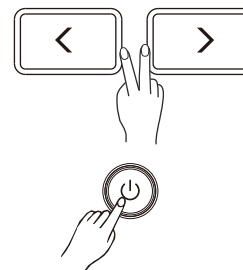



# Quick Play

## Drum Kits and Voices

A drum kit is the voices combination of all pads and cymbals. An acoustic drum has only one fixed kit and it's unchangeable. However, a digital drum is preset with various voices of different styles and some characterized voices of similar styles, allowing you to combine different voices and make as many drum kits as you like. (Please refer to **Drum Kit List** and **Drum Voice List**)

## Selecting a Drum Kit

1. Press the [KIT] button to enter KIT menu. The "KIT" indicator appears on LCD.
2. Press the [^]/[v] buttons to select an item to edit. Then use the data dial or [<]/[>] buttons to select a desired drum kit and adjust the kit volume.

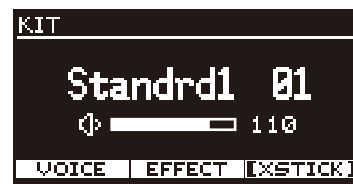

## Selecting a Voice

Strike the pads and enjoy the ensemble sound effect. You can also change the voice setting for each pad as desired.

1. Press the [KIT] button to enter KIT menu. Then press the [F1 (VOICE)] button to enter VOICE menu.
2. Strike the pad that you want to edit. The LCD will display the pad name.
3. Press the [^]/[v] buttons to select an item to edit. Then use the data dial or [<]/[>] buttons to select a desired voice and adjust relevant settings.

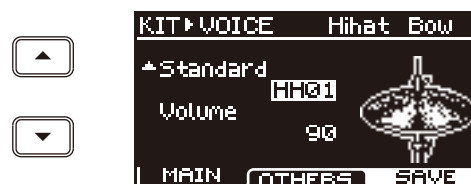

## Playing Techniques

This section introduces various performing techniques to make your performance more professional. Similar to an acoustic drum kit, the digital drum responds differently to various playing techniques and dynamics. All the pads are velocity sensitive. And some voices change timbre depending on the striking force.

### Pad

The snare drum can detect head shot, rim shot and cross stick. The tom drum pad can respond head and rim shot.

### Head Shot

Strike only the head of the pad.

### Rim Shot

Strike the head and the rim of the pad simultaneously. Or strike only the rim of the pad.

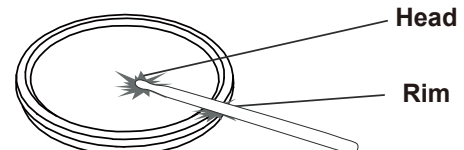
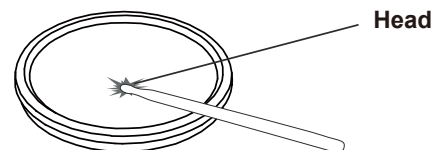

# Quick Play

## Cross Stick (X Stick)

When X-STICK is in use, strike the snare rim slightly and it will respond X-STICK effect. However, if you strike the snare rim with force, it will respond Rim Shot.

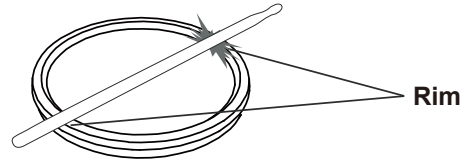

## Cymbal

### Cymbal Bow Shot

Strike the middle area of the cymbal.

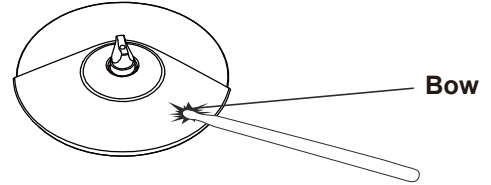

### Cymbal Edge Shot

Strike the edge area of the cymbal.

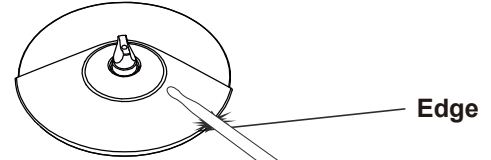

### Cymbal Bell Shot

Strike the Ride bell area of the cymbal.

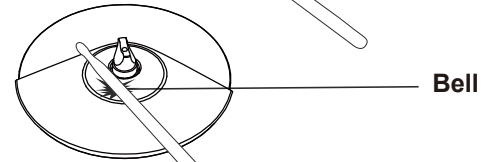

## Choke Play

Both Ride and Crash cymbals have cymbal choke.

Choking the crash/ride edge with the hand immediately after hitting the crash/ride will mute the crash/ride sound.

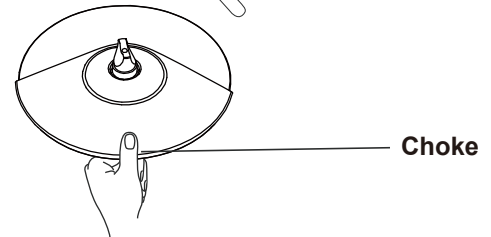

## Hi-Hat

### Hi-Hat Pedal Change

Press down the pedal to different positions, the pad voice will change along when striking the Hi-Hat pad. This is similar to an acoustic drum.

### Open Hi-Hat

Strike the Hi-Hat pad without pressing the pedal.

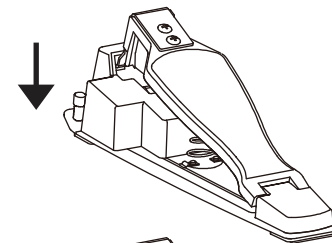

### Closed Hi-Hat

Strike the Hi-Hat pad with the pedal pressed completely down.

### Hi-Hat Pedal

Press down the hi-hat control pedal to create a foot-close sound without having to strike the hi-hat pad.

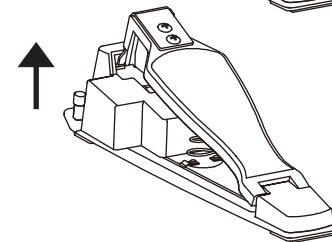

### Splash

Play the hi-hat with the pedal fully pressed and then instantly releasing it.

# Drum Kit

## Preset, User and iKit Drum Kits

**Preset drum kit:** kits that are preset on the module. Changes of kit parameters cannot be saved to a preset drum kit.

**User drum kit:** kits parameters are changeable and can be saved on the module.

**iKit drum kit:** unique kits of this digital drum. The iKit feature will dramatically enhance the sensitivity of the snare when you play with low velocity.

The module provides 55 drum kits, including 35 preset drum kits (no.1~35), 20 user drum kits (no. 35~55). In addition, there are 5 individual iKit drum kits for iKit feature.

### Notes:

1. In iKit mode, it affects only the sensitivity of the snare when you play with low velocity. You can play the other triggers as in a normal drum kit.
2. In iKit mode, these parameters of snare head are not changeable: voice, pitch and decay etc. But you can adjust the other parameters as desired.
3. In iKit mode, the Trigger menu is not available. Trigger parameters are not editable.
4. In iKit mode, it requires proper grounding when connecting devices to the AUXIN and OUTPUT jacks.

You can edit the parameters of a drum kit, and then save it to a user drum kit. Please refer to **Drum Kit List** for details.

### The structure of a drum kit:

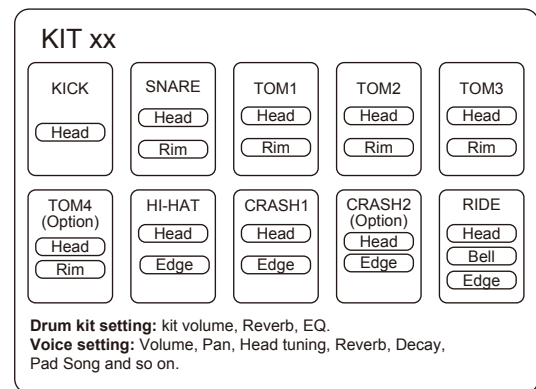

## Selecting a Drum Kit

1. Press the [KIT] button to enter KIT menu. The LCD displays the current kit number and kit volume. Press the [KIT] button again to enter iKIT menu. Pressing the [KIT] button will toggle between KIT menu and iKIT menu.
2. In KIT/iKIT menu, use the [<]/[>] buttons or the data dial to select a desired drum kit.
3. In KIT/iKIT menu, press the [V] button to select the volume item, then use the [<]/[>] buttons or the data dial to adjust the volume.

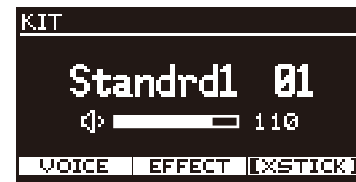

Functions of [F1]~[F3] buttons in KIT/iKIT menu:

Button	Parameter on LCD	Parameter Name	Description
[F1]	VOICE	Voices in current kit	Edit voice parameters.
[F2]	EFFECT	Drum kit effect	Edit drum kit effects, only for kit mode
[F3]	XSTICK	Cross stick	Switch cross stick on or off.

After entering the relevant sub-menu, use the [^]/[v] buttons to select a parameter to edit, then use the data dial or [<]/[>] buttons to adjust the settings.

# Drum Kit

## Edit the Kit Parameters

1. Press the [KIT] button to enter KIT menu, then press the [F1(VOICE)] to enter VOICE menu.
2. When editing voice and effect parameters, save it to a user kit after editing, otherwise, the edited data will be lost when you select a different drum kit or power off the module.

Functions of [F1]~[F3] buttons in KIT-VOICE menu:

Button	Parameter on LCD	Parameter Name	Description
[F1]	MAIN	Main parameters in voice menu	Edit important and frequently used parameters.
[F2]	OTHERS	Common parameters in voice menu	Edit other parameters of voice.
[F3]	SAVE	Save kit	Save the settings to a user kit.

## Editing Main Parameters

1. Press the [KIT] button, then press [F1 (VOICE)] to enter VOICE menu.
2. Select a trigger pad.  
Strike the pad that you want to edit. The LCD will display the selected pad name.  
You can also use the [^]/[v] buttons to select the pad item, then use the data dial or [<]/[>] buttons to select a pad name.
3. Select a voice.  
Press the [^]/[v] buttons to select the voice item, then use the data dial or [<]/[>] buttons to select a desired voice.
4. Adjust the volume.  
Press the [^]/[v] buttons to select the volume item, then use the data dial or [<]/[>] buttons to adjust the volume.

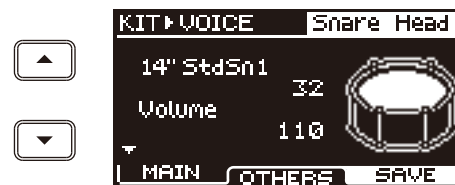

5. Parameters and their range:

Voice Parameter	Description	Range
Number	Select a voice.	1~580
Volume	Adjust the voice volume.	0~127

### Notes:

1. For voice details, please refer to the **Drum Voice List**.
2. The indicator “▼” on LCD means you can use the [v] button to move the cursor downwards to select a parameter. In the same way, the indicator “▲” on LCD suggests that you can use the [^] button to move the cursor upwards to select a parameter.

## Editing Other Parameters

1. Press the [KIT] button, then press [F1 (VOICE)], and then press [F2 (OTHERS)] to enter KIT-EDIT menu.
2. Select a trigger pad.  
Strike the pad that you want to edit. The LCD will display the selected pad name.  
You can also use the [^]/[v] buttons to select the pad item, then use the data dial or [<]/[>] buttons to select a pad name.
3. Select a parameter to edit.  
Press the [^]/[v] buttons to select a parameter, then use the data dial or [<]/[>] buttons to change the setting.

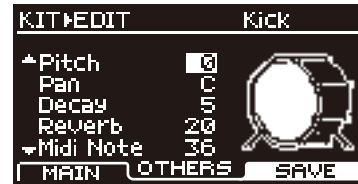
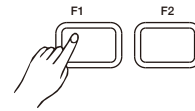

### 4. Parameters and their range:

Voice Parameter	Description	Range
Pitch	Pitch.	-8~+8
Pan	Pan	L8~C~R8
Decay	Decay	0~5
Reverb	Reverb level	0~127
Midi Note	MIDI notes transmitted from MIDI OUT.	0~127
Pad Ptn	Select a song for pad pattern; the selected song will play back when you hit the pad. Selecting "OFF" will disable this function.	OFF, 1~80
Min Velocity	Set the minimum velocity. When the pad is struck at a smaller velocity, it will respond the minimum velocity. A high values will produce a loud sound even if the pad is hit softly.	1~127
Strainer	Switch the strainer effect on or off. Only for snare pad voices that contain strainer effect.	--, OFF, ON

## Editing Kit Effect

1. Press the [KIT] button, then press [F2 (EFFECT)] to enter EFFECT menu.
2. The EFFECT menu contains two effects: REVERB and EQ. Use the [F1]/[F2] buttons to select.

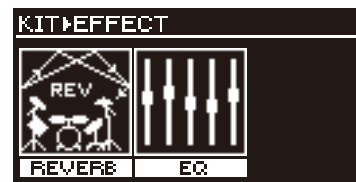
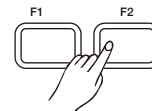

### REVERB

1. Press the [KIT] button, then press [F2 (EFFECT)], and then press [F1 (REVERB)] to enter REVERB menu.
2. Press the [^]/[v] buttons or [F1]/[F2] buttons to select a parameter, then use the data dial or [<]/[>] buttons to change the setting.



### 3. Parameters and their range:

Reverb Parameter	Description	Range
Type	Reverb type	Room1, Room2, Room3, Hall1, Hall2, Church, Delay, Pan Delay
Level	Reverb level	0~127
Time	Reverb time for Room1, Room2, Room3, Hall1, Hall2, Church	0.30~12.00s
	Reverb time for Delay and Pan Delay	0~325ms

# Drum Kit

## EQ

1. Press the [KIT] button, then press [F2 (EFFECT)], and then press [F2 (EQ)] to enter EQ menu.
2. Press the [^]/[v] buttons or [F1]/[F2] buttons to select a parameter, then use the data dial or [<]/[>] buttons to change the setting.
3. Parameters and their range:

EQ Parameter	Description	Range
Low Freq	Low-band frequency cutoff	50~20000Hz
Low Gain	Low-band frequency gain	-12 dB~+12dB
Mid Freq	Mid-band frequency	50~20000Hz
Mid Gain	Mid-band frequency gain	-12 dB~+12dB
Mid Q	Mid-band frequency Q value	0.00~12.00
High Freq	High-band frequency cutoff	50~20000Hz
HighGain	High-band frequency gain	-12 dB~+12dB



## Saving a User Kit

1. Press the [KIT] button, then press [F1 (VOICE)] to enter VOICE menu.
2. Select and edit voice-related parameters, such as voice parameters, reverb and EQ etc.
3. After editing, press [F3 (SAVE)] to enter SAVE menu.
4. Press the [^]/[v] buttons to select a user kit where the edited data will be saved.  
**Note:** If you press [EXIT] at this stage, it will quit without saving and return to VOICE menu.
5. Press [F3 (ENTER)] to enter RENAME menu. Now you can rename the user kit.

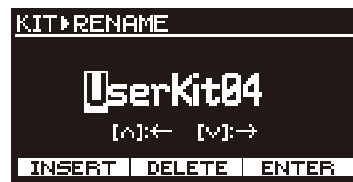
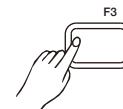
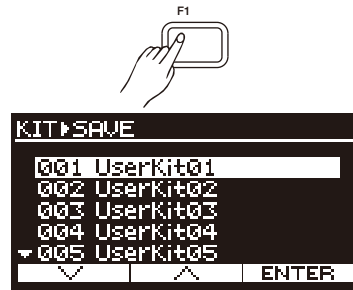

Button operation in RENAME menu:

Button	Description
[^]/[v]	Move the cursor to the left or to the right.
Data dial or [<]/[>]	Change the selected character.
[F1]	Insert a space on the left side of the selected character, and this character will move one space to the right.
[F2]	Delete the selected character, and the next character will move one space to the left.
[F3]	Confirm and save.
[EXIT]	Return to the previous menu.

**Note:** You can enter 12 characters at most for each name.

6. After renaming, press [F3 (ENTER)] to confirm and save the user kit. When saving successfully, the LCD will prompt "Save OK!", and then return to the corresponding KIT menu. Unsupported save under iKit mode.

# Drum Kit

**Notes:**

1. Kit parameters include voice and effect parameters for each trigger.
2. After editing, if you do not save it, the edited data will be lost when you select a different drum kit or turn off the module.
3. After editing, if you do not save the edited kit parameters but directly enter record mode, it will use the default kit settings for recording.
4. As long as you do not switch to a different drum kit, the currently edited voice settings will not be lost even when you select a different menu.

# Click

Click is a major function of digital drum. It helps you play in a steady tempo.

## Turn the click on/off

1. Press the [CLICK] button to enter CLICK menu and start playing the click. The button LED will blink in sync with the click sound.
2. Press the [CLICK] button again to exit CLICK menu and stop the click sound. The button LED turns off.

**Note:**

In CLICK menu, if you press [EXIT], it will exit CLICK menu, but will not stop the click sound.

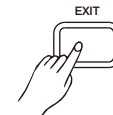
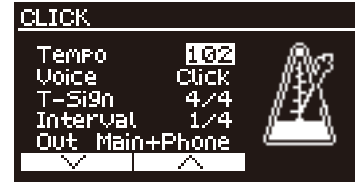
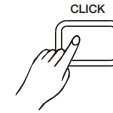

## Editing Click Parameters

In CLICK menu, press the [^]/[v] buttons to select a parameter, then use the data dial or [<]/[>] buttons to change the setting.

Click parameters and their range:

Parameter	Range	Description
Tempo	30 ~280	Click tempo
Voice	Click, Clave, Stick, CoClick, FmClick, Voice1, Voice2	Click voice
T-Sign	0/2~9/2, 0/4~9/4, 0/8~9/8, 0/16~9/16	Click time signature
Interval	1/2, 3/8, 1/4, 1/8, 1/12, 1/16	Click interval
Out	Phone, Main+Phone	To output the click sound from just the Phones jack or from the Phones and Output jacks.



# Song

The module features a variety of preset songs and user songs. Try selecting your favorite songs and play along with them. Please refer to **Song List** for details.

## Playing Preset Songs

1. Press the [SONG] button to enter SONG ▶ MODULE menu.
2. Press the [^]/[v] buttons to select the song number item or the song volume item. Then use the data dial or [<]/[>] buttons to select a desired song or adjust the volume range from 000 to 127.
3. Press the [▶|■] button to start/stop playing the selected song. During playback, the LCD will display the measure count.
4. In SONG ▶ MODULE menu, press the [F1 (LIST)] to enter SONG ▶ LIST menu.
5. In SONG ▶ LIST menu, use the [^]/[v] buttons, the data dial or [<]/[>] buttons to select a desired song, then press the [▶|■] button to start/stop the playback.
6. In SONG ▶ LIST menu, press [F1 (GROUP)] to toggle between two song groups: PTN and USER. After selecting a song, press the [SONG] button to return to SONG ▶ MODULE menu.
7. In SONG ▶ MODULE menu or SONG ▶ LIST menu, press [F3 (TEMPO)] to display the current tempo. When tempo is displayed, use dial or [<]/[>] buttons to adjust the tempo from 30 to 280.



Song Groups:

Song	Group	Song No.	Description
Preset	Ptn	1~80	Pattern is rhythmic music. When pattern playback is finished, it will automatically start again from the beginning until you press the [▶ ■] button.
User	User	81~85	Recorded songs.

## Playing Along with a Song

1. Select a desired song, then press the [▶|■] button to start playback. Now you can play along and strike the drum pads.
2. To adjust the tempo of preset songs, press the [F3 (TEMPO)] and then use the [<]/[>] buttons to change the tempo value.
3. Press the [CLICK] to turn the click on or off.



CLICK



# Recording

## Prepare and Start Recording

### To record without song accompaniment:

In KIT menu, press the [ ● ] button to enter record mode.



### To record with song accompaniment:

In SONG menu, press the [ ● ] button to enter record mode. It will use the selected song as accompaniment.

#### 1. Press the [ ● ] button to enter REC menu.

The click will be turned on. You can press the [CLICK] button to mute the click sound, but the [CLICK] button LED will keep blinking.



#### 2. In REC menu, you can adjust the following settings:

- Use the data dial or [<]/[>] buttons to select a user song to which recording will be saved.
- Press [F1 (P-CNT)] to turn the pre-count function on or off.
- Press [F3 (TEMPO)] to display the tempo, then use the data dial or [<]/[>] buttons to change the tempo value.



#### 3. Press the [▶|■] button or simply hit a pad to start recording. Song accompaniment and drum performance will be recorded, but the click sound will not be recorded.

### Note:

During recording, only these buttons are available: [F3 (STOP)], [CLICK], [EXIT] and [▶|■].

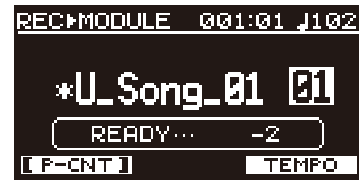

## Rename and Save MIDI Recording

During recording, you can press [F3 (STOP)], [▶|■] or [EXIT] to stop recording and enter RENAME menu.



Button operation in RENAME menu:

Button	Description
[^]/[v]	Move the cursor to the left or to the right.
Data dial or [<]/[>]	Change the selected character.
[F1]	Insert a space on the left side of the selected character, and this character will move one space to the right.
[F2]	Delete the selected character, and the next character will move one space to the left.
[F3]	Confirm and save.
[EXIT]	Exit RENAME menu, and save it in the default name "U_Song_xx".

### NOTE:

1. You can enter 12 characters at most for a name.
2. If you use a user kit for MIDI recording, but switch to a different drum kit for playback, the playback effect may be different from recording.
3. iKit mode doesn't support recording.



# Coach

Coach function provides very unique practice patterns which are designed especially for beginners to help them improve playing accuracy, speed and persistence, as well as other skills on the whole.

Press the [COACH] function to enter coach mode.



Coach mode contains three parts: Quiet Count, Beat Check and Change Up. Each of them has its own feature and the latter two provide score function.

**Note:**

In Beat Check or Change Up, if score function is disabled, you will hear a beat sound playing during the practice. However, if score function is in use, the beat sound will be muted, and you can follow the beat count on LCD and strike the pads.

## Quiet Count

Quiet Count is a fundamental practice of tempo. It will play a complete tempo demo at the beginning, and then mute the sound so that you can hit the pads in quiet count.

1. Press the [COACH] button to enter COACH menu, then press [F1 (QUIET)] to select Quiet Count.

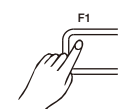

Quiet Count parameters and their range:

Parameter	Range	Description
 01 ~ 05	01 ~ 05	Select a beat type.
Mode	1-1, 2-2, 1-3	<b>1-1:</b> play one measure of demo, then play one measure of quiet count; <b>2-2:</b> play two measures of demo, then play two measures of quiet count; <b>1-3:</b> play one measure of demo, then play three measures of quiet count;
Measure Hint	ON, OFF	Turn the accent hint on or off.
Tempo	30 ~ 280	Adjust the tempo.

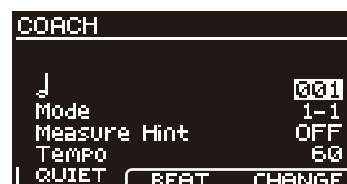

Press the [^]/[v] buttons to select a parameter, then use the data dial or [<]/[>] buttons to change the setting.

2. Press the [▶|■] button to start the practice.  
It will play a count-in of about one measure length, then play the demo with click sound. Try catching the beats. When demo stops, the click sound will be muted and "HIT!" will appear on LCD, indicating that you can hit the pad now. The LCD will show the accuracy of each hit. During practice, you can press [F3 (TEMPO)] to edit the tempo.

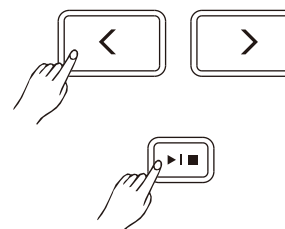

3. Press the [▶|■] button again to stop the practice.

**Note:**

During practice, you can check the accuracy of each hit on the LCD.



# Coach

## Beat Check

Beat Check helps improve your playing accuracy of each hit. It provides 15 different beat types. You can select a desired beat type and practice with click sound. Your performance will be scored when score function is in use.

1. Press the [COACH] button to enter COACH menu, then press [F2 (BEAT)] to select Beat Check.

Beat Check parameters and their range:

Parameter	Range	Description
	1 ~ 15	Select a beat type.
Score	OFF, ON(8Meas), ON(16Meas), ON(32Meas)	Turn the score function on or off; select the number of measures for practice.
Measure Hint	ON, OFF	Turn the accent hint on or off.
Tempo	30 ~ 280	Adjust the tempo.

Press the [^]/[v] buttons to select a parameter, then use the data dial or [<]/[>] buttons to change the setting.

2. Press the [▶|■] button to start the practice. It will play a count-in of about one measure length, then you can follow the click sound and strike the pad. The LCD will show the accuracy of each hit. During practice, you can press [F3 (TEMPO)] to edit the tempo.

3. Press the [▶|■] button again to stop the practice.

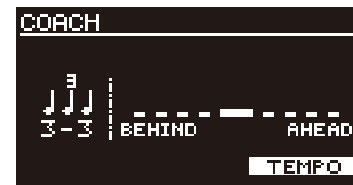
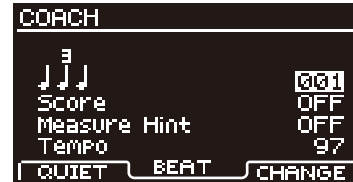
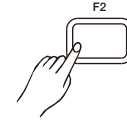

## Change Up

Change Up aims to foster your capacity to play with changing beats. It will play the first two measures of a beat type and then shift to a different beat type. Beat indicator on LCD will blink to indicate that it will change to this beat type in the next measure.

1. Press the [COACH] button to enter COACH menu, then press [F3 (CHANGE)] to select Change Up.

Beat Check parameters and their range:

Parameters	Range	Description
	1 ~ 3	Select a change-up pattern.
Score	OFF, ON(2Loop), ON(4Loop)	Turn the score function on or off; select the number of loops for practice.
Measure Hint	ON, OFF	Turn the accent hint on or off.
Tempo	30 ~ 280	Adjust the tempo.

Press the [^]/[v] buttons to select a parameter, then use the data dial or [<]/[>] buttons to change the setting.

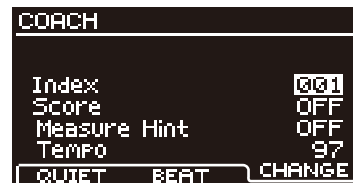
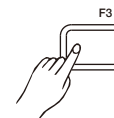

# Coach

- Press the [▶|■] button to start the practice. It will play a count-in of about one measure length, then you can start practice. The LCD will show the accuracy of each hit. Prior to beat changing, the beat indicator will blink and "CHANGE!" will appear on LCD, indicating it will change to this beat type in the next measure. During practice, you can press [F3 (TEMPO)] to edit the tempo.

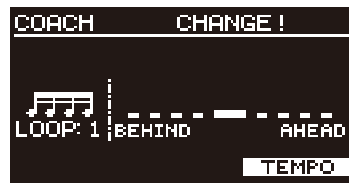

- Press the [▶|■] button again to stop the practice.

**Note:**

When score function is in use, it will automatically stop and score the practice after the specified loops are finished.

# Volume Sliders

You can use the volume sliders to adjust the relevant volumes respectively.

Press the [1↓] button to select a group of parameters to edit. LED of the selected group will be lit. Now you can move the sliders to adjust the volumes of the selected group.

Upper Group (corresponding to the upper LED)	
KICK	Kick volume
SNARE	Snare volume
TOM1	Tom 1 volume
TOM2	Tom 2 volume
TOM3	Tom 3 volume
TOM4	Tom 4 volume
Lower Group (corresponding to the lower LED)	
HI-HAT	Hi-hat & hi-hat pedal volume
CRASH1	Crash 1 volume
CRASH2	Crash 2 volume
RIDE	Ride volume
KIT	Drum kit volume
SONG	Song playback volume

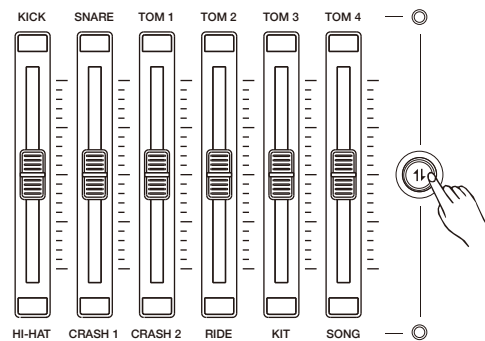

**For example, adjust the snare volume.**

- Press the [1↓] button to select the upper group which the snare volume belongs to. The upper group LED will be lit.
- Move the SNARE slider to adjust the snare volume.

**Note:**

Pressing the [1↓] button will not affect the current volume. The relevant volume will change only when you move the slider.

# Settings

## Trigger Settings

You can adjust trigger parameters to suit your playing habits and optimize the digital drum for best performance.

The module provides a group of preset trigger settings. You can edit the relevant parameters and save it on the module. If you do not save the edited data, it will be lost after power off.



### Editing Trigger Parameters

1. Press the [KIT] button, then press the [MENU] button.
2. Press the [^]/[v] buttons or [F1]/[F2] buttons to select "Trigger", then press [F3 (ENTER)] to enter TRIGGER menu.
3. Press the [^]/[v] buttons or [F1]/[F2] buttons to select a parameter to edit, then use the data dial or [<]/[>] buttons to change the setting. After editing, press [F3 (ENTER)] to save, otherwise, the edited data will be lost after power off.



### Trigger parameters and their range:

Parameter	Range	Description
Head Sensi	0 ~15	Adjust the pad sensitivity. A high value will produce loud sound, even you strike softly. A low value will produce low sound, even you strike heavily.
Rim Sensi	0 ~15	Adjust the sensitivity of rim shot.
Threshold	0 ~15	Trigger signal will produce sound only when it is above the threshold level. Although this setting can prevent unwanted sounding, such as crosstalk from other pads, if set to a higher level, no sound will be produced when you strike lightly. For example, B will produce sound but A and C will not. To get a proper threshold value: 1. Set the value to a low level. 2. Raise the value gradually while striking the pad. 3. Repeat step2 until you get an appropriate level.
Head/Rim Adj	0 ~15	Adjust the disturbance between head and rim shot. (Only for Snare and Tom)
X-STICK Level	--, 0~4	When the value is set to "0", it plays only the rim shot sound, but no cross stick sound. As the value increases, the cross stick sound will be more noticeable. Note: This parameter is not available until X-Stick function is turned on in KIT menu.
X-Talk	0 ~15	Crosstalk means when hitting a pad, another pad is mistakenly triggered, which should have been avoided. This may happen when two pads sit on the same stand. For example: when you hit the Snare, if both Snare and Tom1 produce sound, you can raise Tom1's "XTALK" value to prevent crosstalk. Note: Make sure the "XTALK" value is set to a proper level. If the value is set too high, when you hit two pads at the same time, the pad being struck gently may be judged as "crosstalk" and will not produce sound.
Curve	Normal, EXP-1, EXP-2, LOG-1, LOG-2, Loud	This setting adjusts the relationship between the striking force and the response volume. Please refer to Curve description in this chapter.
Retrig-C	0~15	This setting is to cancel "re-triggering". Re-triggering means when you strike a pad, you hear two sounds from this strike because of pad vibration. Note: If the value is set too high, sounds may be omitted when you play fast; if the value is set too low, re-triggering may not be prevented. Better set the value to the minimum level required but still can prevent re-triggering.
Close Point	0~2	Adjust the close point settings.
Pedal Sensi	0~15	Adjust the sensitivity of hi-hat control pedal.
Splash-Sensi	0~5	Adjust the splash sensitivity. When set to a higher value, it becomes easier to play the splash.
Bow-Sensi	0 ~ 15	Adjust the sensitivity of cymbal bow.
Edge-Sensi	0 ~ 15	Adjust the sensitivity of cymbal edge.
Bell-Sensi	0 ~ 15	Adjust the sensitivity of cymbal bell.

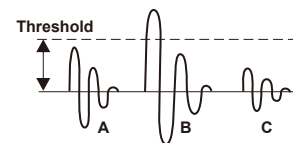

# Settings

## Curve description:

Curve	Description
Normal	The most natural setting. There is a linear change between playing dynamics and volume response.
Exp-1, Exp-2	Comparing to Normal, heavy strike will produce greater volume change.
Log-1, Log-2	Comparing to Normal, gentle strike will produce greater volume change.
Loud	Even a soft strike will produce strong volume, and the range of dynamic response is small.

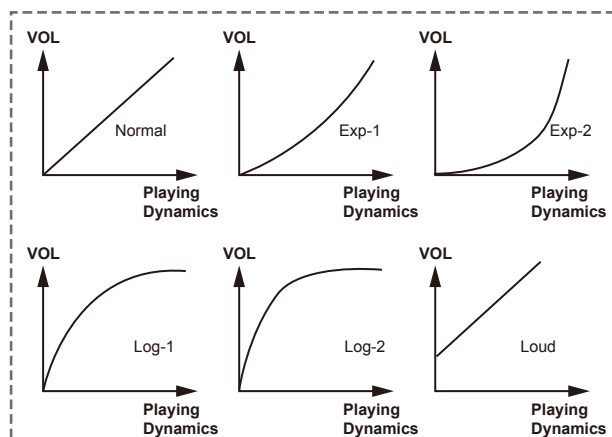

## Default MIDI notes of all triggers:

Trigger	MIDI	Trigger	MIDI	Trigger	MIDI	Trigger	MIDI	Trigger	MIDI
Kick	36	Tom1 Rim	50	Tom4 Head	41	Crash1 Bow	49	Close Hihat	42
Snare Head	38	Tom2 Head	45	Tom4 Rim	39	Crash1 Edge	55	Open Hihat Edge	26
Snare Stick	37	Tom2 Rim	47	Ride Bow	51	Crash2 Bow	57	Close Hihat Edge	22
Snare Rim	40	Tom3 Head	43	Ride Edge	59	Crash2 Edge	52	Pedal	44
Tom1 Head	48	Tom3 Rim	58	Ride Bell	53	Open Hihat	46	Hihat Splash	21

### Note:

Save the trigger settings after editing, otherwise, the edited data will be lost after power off.

## Master Compress

Master compress is very useful for professional drummers. It ensures the sound will not be distorted when playing at maximum volume level.

### Editing Master Compress Parameters

1. Press the [KIT] button, then press the [MENU] button.
2. Press the [^]/[v] buttons or [F1]/[F2] buttons to select "Master Compress", then press [F3 (ENTER)] to enter MASTER COMPRESS menu.
3. Press the [^]/[v] buttons or [F1]/[F2] buttons to select a parameter to edit, then use the data dial or [<]/[>] buttons to change the setting. After editing, press [F3 (ENTER)] to save, otherwise, the edited data will be lost after power off.

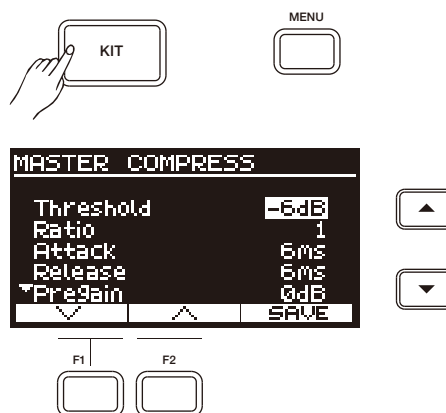

### Master Compress parameters and their range:

Parameter	Range	Description
Threshold	0 ~ -30dB	Only those signals that are above the threshold level will be compressed.
Ratio	1 ~25	Compression ratio.
Attack	6 ~50ms	The interval from when the volume goes above threshold until compression starts.
Release	6 ~699ms	The interval from when the volume falls under threshold until compression stops.
PreGain	-60 ~12dB	Output level of compression.

# Settings

## MIDI Setup

1. Press the [KIT] button, then press the [MENU] button.
2. Press the [^]/[v] buttons or [F1]/[F2] buttons to select "Midi Setup", then press [F3 (ENTER)] to enter MIDI SETUP menu.
3. Press the [^]/[v] buttons or [F1]/[F2] buttons to select a parameter to edit, then use the data dial or [<]/[>] buttons to change the setting. After editing, press [F3 (ENTER)] to save, otherwise, the edited data will be lost after power off.

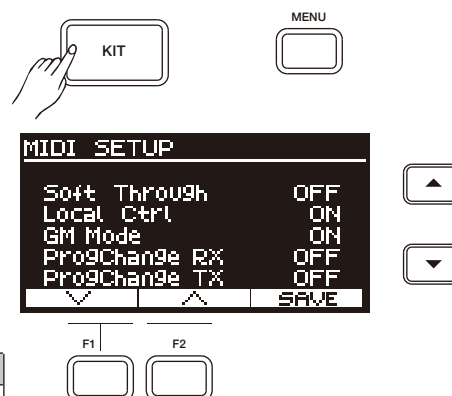

### MIDI Setup parameters and their range:

Parameter	Range	Description
Soft Through	ON, OFF	Message received from MIDI IN will be transmitted to MIDI OUT.
Local Control	ON, OFF	ON: Performance MIDI events from pads will be transmitted to the module and MIDI OUT. OFF: Performance MIDI events from pads will be transmitted to MIDI OUT only.
GM Mode	ON, OFF	ON: MIDI channel 10 will respond GM drum kit. OFF: MIDI channel 10 will respond local drum kit.
Prog Change RX	ON, OFF	ON: MIDI channel 10 will respond the program change MIDI message. OFF: MIDI channel 10 will ignore the program change MIDI message.
Prog Change TX	ON, OFF	ON: Send program change MIDI message from MIDI channel 10 when changing the local drum kit number. OFF: Do not send program change MIDI message from channel 10 when changing the local drum kit number.

## Auto Power Off

This function will automatically turn off the power after a period of time when the module is not in use.

Note: This function is not available during song playback, during recording or when MIDI IN jack is receiving data.

1. Press the [KIT] button, then press the [MENU] button.
2. Press the [^]/[v] buttons or [F1]/[F2] buttons to select "Option", then press [F3 (ENTER)] to enter OPTION menu.
3. Press the [^]/[v] buttons or [F1]/[F2] buttons to select a parameter to edit, then use the data dial or [<]/[>] buttons to change the setting. After editing, press [F3 (ENTER)] to save, otherwise, the edited data will be lost after power off.

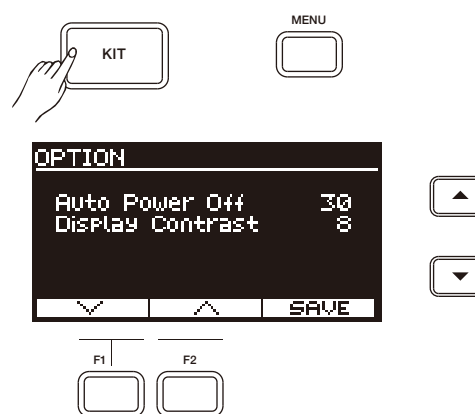

### Option parameters and their range:

Parameter	Range	Description
Auto Power Off	OFF, 30, 60	OFF: Auto power off is disabled. 30, 60: The module will shut down after 30 min or 60 min when it is not used.
Display Contrast	1~16	Adjust the contrast ratio of display.



## Factory Reset

In Factory Reset, you can restore factory settings respectively for drum kits, songs, triggers.

1. Press the [KIT] button, then press the [MENU] button.
2. Press the [^]/[V] buttons or [F1]/[F2] buttons to select "Factory Reset", then press [F3 (ENTER)] to enter FACTORY RESET menu.
3. Press the [^]/[V] buttons or [F1]/[F2] buttons to select a parameter, then press [F3 (ENTER)] to proceed.

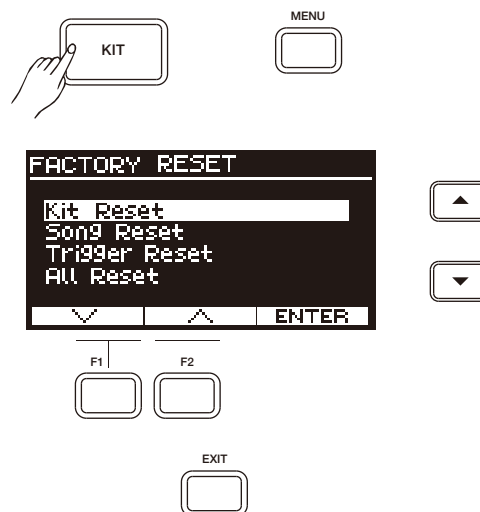

4. A confirmation message will prompt on LCD. Press [F3 (ENTER)] to execute factory reset; or press [EXIT] to cancel.

### Factory Reset parameters:

Parameter	Description
Kit Reset	Restore user drum kits to factory settings.
Song Reset	Restore user songs to factory settings.
Trigger Reset	Restore user trigger to factory settings.
All Reset	Parameters which will be restored to factory settings: user kits, user songs, user trigger, MIDI setting, Option setting and Master Compress setting etc.

### Note:

Do not turn off the power when factory reset is in progress. If power supply is accidentally disconnected, execute factory reset again, otherwise it may corrupt the internal data and cause malfunction.

# Specifications

<b>Drum Kits</b>
Kit: 35 Presets + 20 Users
<b>Voices</b>
Preset: 580 (Percussion Voice, Effect Voice)+ 17 Hi-hat Combination
<b>Sequencer</b>
Preset: 80
User: 5
Tick: 192 ticks per beat
Record: Real-time recording
Record Capacity: About 2000 notes per song.
<b>Tempo</b>
30~280
<b>Display</b>
64 x 128 dots graphic LCD with backlit
<b>Connectors</b>
TRIGGER INPUT(DB25 Type), TRIGGER IN (TOM4,CRASH2), PHONES(1/4"), AUX IN(1/8"), USB-MIDI, MIDI IN, MIDI OUT, OUTPUT (R,L/MONO)
<b>Control Buttons</b>
Power, Master Volume, Phone Volume, AUX IN Volume, Click Volume, Kit, Song, Record, Start/Stop, Click, Coach, Menu, [^], [v], Exit, F1,F2,F3, Data Dial, Group Faders, Fader Exchange,[<], [>]
<b>Power Supply</b>
DC 9V, 500mA
<b>Dimensions</b>
265(W) x 181(D) x 74(H)mm
<b>Module Weight</b>
0.98Kg

# Drum Kit List

No.	Kit Name
1	Standard 1
2	Acoustic 1
3	Funk
4	Rock
5	Brush 1
6	Latin
7	Funk Band
8	Dubstep
9	Beatbox 1
10	808
11	909
12	HipHop
13	Reggae
14	Jazz
15	Percussion 1
16	Indian
17	African
18	Room
19	Brush 2

No.	Kit Name
20	Fusion
21	Vintage
22	Orchestra
23	Marimba
24	Vibraphone
25	Beatbox 2
26	Power
27	Techno
28	Dance
29	Pop
30	World
31	Lo-Fi
32	R&B
33	Electronic
34	House
35	Live

# iKit List

No	Kit Name
1	iStandard
2	iAcoustic
3	iFunk
4	iRock
5	iBrush

# Drum Voice List

No.	Voice Name
<b>KICK</b>	
1	22" Standard Kick 1
2	22" Standard Kick 2
3	Rock Kick
4	22" Acoustic Kick
5	22" Jazz Kick
6	Vintage Kick 1
7	Brush Kick
8	Funk Kick
9	Room Kick 1
10	Room Kick 2
11	Fusion Kick
12	1970's Kick
13	Vintage Kick 2
14	Reggae Kick
15	Old School Kick
16	Pop Kick
17	Beatbox Kick 1
18	Power Kick
19	808 Kick
20	909 Kick
21	Electronic Kick
22	Dance Kick
23	Beatbox Kick 2
24	FX Mix Kick
25	HipHop Kick
26	Techno Kick
27	Lo-Fi Kick
<b>SNARE</b>	
28	14" Standard Snare 1
29	14" Standard Snare Rim 1
30	14" Rock Snare
31	14" Rock Snare Rim
32	14" Acoustic Snare
33	14" Acoustic Snare Rim
34	14" Funk Snare 1
35	14" Funk Snare Rim 1
36	14" Jazz Snare
37	14" Jazz Snare Rim
38	14" Funk Snare 1
39	Room Snare Rim
40	Fusion Snare
41	Fusion Snare Rim
42	14" Standard Snare 2
43	14" Standard Snare Rim 2
44	14" Funk Snare 2
45	14" Funk Snare Rim 2
46	Vintage Snare
47	Vintage Snare Rim
48	Brush Snare 1
49	Brush Snare Rim 1
50	Brush Snare 2
51	Brush Snare Rim 2
52	Live Snare

53	Live Snare Rim
54	Orchestra Snare
55	Orchestra Snare Rim
56	Reggae Snare
57	Reggae Snare Rim
58	Old School Snare
59	Old School Snare Rim
60	R&B Snare
61	R&B Snare Rim
62	Dubstep Snare
63	Beatbox Snare 1
64	Beatbox Snare Rim 1
65	HipHop Snare
66	Dubstep Snare
67	808 Snare Rim
68	909 Snare
69	909 Snare Rim
70	Electronic Snare
71	Power Snare
72	Dance Snare
73	Dance Snare Rim
74	House Snare
75	House Snare Rim
76	Lo-Fi Snare
77	Lo-Fi Snare Rim
78	Beatbox Snare 2
79	Beatbox Snare Rim 2
80	Techno Snare
81	Techno Snare Rim
82	Standard Snare Stick 1
83	Rock Snare Stick
84	Acoustic Snare Stick
85	Funk Snare Stick 1
86	Jazz Snare Stick
87	Room Snare Stick
88	Fusion Snare Stick
89	Standard Snare Stick 2
90	Funk Snare Stick 2
91	Brush Snare Stick
92	Brush Snare Stick 2
93	Vintage Snare Stick
94	Live Snare Stick
95	Beatbox Snare Stick 1
96	Beatbox Snare Stick 2
97	808 Snare Stick
98	909 Snare Stick
99	Electronic Snare Stick
100	Old School Snare Stick
101	House Snare Stick
102	Lo-Fi Snare Stick
103	Techno Snare Stick
104	Brush Swirl
<b>Tom</b>	
105	Standard Tom 1
106	Standard Tom 1 Rim

107	Standard Tom 2
108	Standard Tom 2 Rim
109	Standard Tom 3
110	Standard Tom 3 Rim
111	Standard Tom 4
112	Standard Tom 4 Rim
113	Standard Tom 5
114	Standard Tom 5 Rim
115	Standard Tom 6
116	Standard Tom 6 Rim
117	Rock Tom 1
118	Rock Tom 1 Rim
119	Rock Tom 2
120	Rock Tom 2 Rim
121	Rock Tom 3
122	Rock Tom 3 Rim
123	Rock Tom 4
124	Rock Tom 4 Rim
125	Rock Tom 5
126	Rock Tom 5 Rim
127	Rock Tom 6
128	Rock Tom 6 Rim
129	Acoustic Tom 1
130	Acoustic Tom 1 Rim
131	Acoustic Tom 2
132	Acoustic Tom 2 Rim
133	Acoustic Tom 3
134	Acoustic Tom 3 Rim
135	Acoustic Tom 4
136	Acoustic Tom 4 Rim
137	Acoustic Tom 5
138	Acoustic Tom 5 Rim
139	Acoustic Tom 6
140	Acoustic Tom 6 Rim
141	Brush Tom 1
142	Brush Tom 1 Rim
143	Brush Tom 2
144	Brush Tom 2 Rim
145	Brush Tom 3
146	Brush Tom 3 Rim
147	Brush Tom 4
148	Brush Tom 4 Rim
149	Brush Tom 5
150	Brush Tom 5 Rim
151	Brush Tom 6
152	Brush Tom 6 Rim
153	Funk Tom 1
154	Funk Tom 1 Rim
155	Funk Tom 2
156	Funk Tom 2 Rim
157	Funk Tom 3
158	Funk Tom 3 Rim
159	Funk Tom 4
160	Funk Tom 4 Rim
161	Funk Tom 5

# Drum Voice List

162	Funk Tom 5 Rim
163	Funk Tom 6
164	Funk Tom 6 Rim
165	Vintage Tom 1
166	Vintage Tom 2
167	Vintage Tom 3
168	Vintage Tom 4
169	Vintage Tom 5
170	Vintage Tom 6
171	Fusion Tom 1
172	Fusion Tom 2
173	Fusion Tom 3
174	Fusion Tom 4
175	Fusion Tom 5
176	Fusion Tom 6
177	1970's Tom 1
178	1970's Tom 1 Rim
179	1970's Tom 2
180	1970's Tom 2 Rim
181	1970's Tom 3
182	1970's Tom 3 Rim
183	1970's Tom 4
184	1970's Tom 4 Rim
185	808 Tom 1
186	808 Tom 2
187	808 Tom 3
188	808 Tom 4
189	808 Tom 5
190	808 Tom 6
191	808 Tom Fx 1
192	808 Tom Fx 2
193	909 Tom 1
194	909 Tom 2
195	909 Tom 3
196	909 Tom 4
197	909 Tom 5
198	909 Tom 6
199	909 Tom 7
200	909 Tom 8
201	Electronic Tom 1
202	Electronic Tom 2
203	Electronic Tom 3
204	Electronic Tom 4
205	Electronic Tom 5
206	Electronic Tom 6
207	Electronic Tom 7
208	Electronic Tom 8
209	Power Tom 1
210	Power Tom 2
211	Power Tom 3
212	Power Tom 4
213	Power Tom 5
214	Power Tom 6
215	Power Tom 7
216	Power Tom 8

217	Beatbox Tom 1
218	Beatbox Tom 2
219	Beatbox Tom 3
220	Beatbox Tom 4
221	Lo-Fi Tom 1
222	Lo-Fi Tom 1 Rim
223	Lo-Fi Tom 2
224	Lo-Fi Tom 2 Rim
225	Lo-Fi Tom 3
226	Lo-Fi Tom 3 Rim
227	Lo-Fi Tom 4
228	Lo-Fi Tom 4 Rim
229	Lo-Fi Tom 5
230	Lo-Fi Tom 5 Rim
231	Lo-Fi Tom 6
232	Lo-Fi Tom 6 Rim
233	Techno Tom 1
234	Techno Tom 1 Rim
235	Techno Tom 2
236	Techno Tom 2 Rim
237	Techno Tom 3
238	Techno Tom 3 Rim
239	Techno Tom 4
240	Techno Tom 4 Rim
241	Techno Tom 5
242	Techno Tom 5 Rim
243	Techno Tom 6
244	Techno Tom 6 Rim
245	Dubstep Tom 1
246	Dubstep Tom 1 Rim
247	Dubstep Tom 2
248	Dubstep Tom 2 Rim
249	Dubstep Tom 3
250	Dubstep Tom 3 Rim
251	Dubstep Tom 4
252	Dubstep Tom 4 Rim
<b>Ride</b>	
253	20" Standard Ride
254	20" Standard Ride Edge
255	20" Standard Ride Bell
256	20" Rock Ride
257	20" Rock Ride Edge
258	20" Rock Ride Bell
259	22" Acoustic Ride
260	22" Acoustic Ride Edge
261	22" Acoustic Ride Bell
262	20" Funk Ride
263	20" Funk Ride Edge
264	20" Funk Ride Bell
265	22" Funk Ride
266	22" Funk Ride Edge
267	22" Funk Ride Bell
268	Brush Ride 1
269	Brush Ride 2
270	20" Room Ride

271	20" Room Ride Edge
272	20" Room Ride Bell
273	20" Metal Ride
274	20" Metal Ride Edge
275	20" Metal Ride Bell
276	Vintage Ride
277	Vintage Ride Edge
278	Vintage Ride Bell
279	22" Big Band Ride
280	22" Big Band Ride Edge
281	22" Big Band Ride Bell
282	Old School Ride
283	Old School Ride Edge
284	Old School Ride Bell
285	808 Ride
286	Electronic Ride
287	Electronic Ride Edge
288	Electronic Ride Bell
289	Dance Ride
290	Dance Ride Edge
291	Dance Ride Bell
292	Lo-Fi Ride
293	Lo-Fi Ride Edge
294	Lo-Fi Ride Bell
295	Dubstep Ride
296	Noise Ride
297	Noise Ride Edge
298	Noise Ride Bell
299	Techno Ride
300	Techno Ride Edge
301	Techno Ride Bell
<b>Crash</b>	
302	16" Standard Crash 1
303	16" Standard Crash 1 Edge
304	Rock Crash
305	Rock Crash Edge
306	16" Acoustic Crash 1
307	16" Acoustic Crash 1 Edge
308	18" Jazz Crash 1
309	18" Jazz Crash 1 Edge
310	18" Jazz Crash 2
311	18" Jazz Crash 2 Edge
312	16" Standard Crash 2
313	16" Standard Crash 2 Edge
314	Brush Crash 1
315	Brush Crash 2
316	Funk Crash 1
317	Funk Crash 1 Edge
318	Funk Crash 2
319	Funk Crash 2 Edge
320	16" Acoustic Crash 2
321	16" Acoustic Crash 2 Edge
322	Orchestra Crash 1
323	Orchestra Crash 2
324	Orchestra Crash 3

# Drum Voice List

325	Room Crash
326	Room Crash Edge
327	1970's Crash
328	1970's Crash Edge
329	Old School Crash 1
330	Old School Crash 1 Edge
331	Vintage Crash 1
332	Vintage Crash 1 Edge
333	Vintage Crash 2
334	Vintage Crash 2 Edge
335	Latin Crash 1
336	Latin Crash 1 Edge
337	Latin Crash 2
338	Latin Crash 2 Edge
339	China 1
340	China 1 Edge
341	China 2
342	China 2 Edge
343	Splash
344	Splash Edge
345	808Crash
346	909Crash 1
347	909Crash 2
348	HipHop Crash
349	Electronic Crash 1
350	Electronic Crash 2
351	Dance Crash 1
352	Dance Crash 2
353	Lo-Fi Crash 1
354	Lo-Fi Crash 1 Edge
355	Lo-Fi Crash 2
356	Lo-Fi Crash 2 Edge
357	Techno Crash 1
358	Techno Crash 1 Edge
359	Techno Crash 2
360	Techno Crash 2 Edge
361	Beatbox Crash
<b>Hi-hat</b>	
362	14" Standard Hi-hat
363	14" Standard Hi-hat Edge
364	14" Standard Hi-hat Pedal
365	14" Standard Hi-hat Splash
366	14" Rock Hi-hat
367	14" Rock Hi-hat Edge
368	14" Rock Hi-hat Pedal
369	14" Rock Hi-hat Splash
370	14" Acoustic Hi-hat
371	14" Acoustic Hi-hat Edge
372	14" Acoustic Hi-hat Pedal
373	14" Acoustic Hi-hat Splash
374	14" Funk Hi-hat
375	14" Funk Hi-hat Edge
376	14" Funk Hi-hat Pedal
377	14" Funk Hi-hat Splash
378	Brush Hi-hat

379	Brush Hi-hat Pedal
380	Brush Hi-hat Splash
381	14" Jazz Hi-hat
382	14" Jazz Hi-hat Edge
383	14" Jazz Hi-hat Pedal
384	14" Jazz Hi-hat Splash
385	808 Hi-hat
386	808 Hi-hat Pedal
387	808 Hi-hat Splash
388	909 Hi-hat
389	909 Hi-hat Pedal
390	909 Hi-hat Splash
391	Dance Hi-hat
392	Dance Hi-hat Pedal
393	Dance Hi-hat Splash
394	Dubstep Hi-hat
395	Dubstep Hi-hat Pedal
396	Beatbox Hi-hat 1
397	Beatbox Hi-hat Pedal 1
398	Beatbox Hi-hat 2
399	Beatbox Hi-hat Pedal 2
400	Lo-Fi Hi-hat
401	Lo-Fi Hi-hat Edge
402	Lo-Fi Hi-hat Pedal
403	Lo-Fi Hi-hat Splash
<b>Percussion</b>	
404	Maracas
405	Sticks
406	Metronome Bell
407	Vibra-slap 1
408	Vibra-slap 2
409	Vibra-slap 3
410	Synthesis Percussion 1
411	Synthesis Percussion 2
412	High Q 1
413	High Q 2
414	Low Q 1
415	Low Q 2
416	Mute Hi Conga 1
417	Mute Hi Conga 2
418	Open Hi Conga 1
419	Open Hi Conga 2
420	Low Conga
421	High Bongo
422	Low Bongo
423	High Timbale 1
424	High Timbale 2
425	High Timbale 3
426	High Timbale 4
427	High Timbale 5
428	Low Timbale 1
429	Low Timbale 2
430	Low Timbale 2 Rim
431	Low Timbale 3
432	Low Timbale 4

433	High Agogo
434	Low Agogo
435	Claves 1
436	Claves 2
437	Jingle Bell 1
438	Jingle Bell 2
439	Cowbell
440	Bell Tree 1
441	Bell Tree 2
442	Tambourine 1
443	Tambourine 2
444	Cabasa
445	Long Guiro
446	Short Guiro
447	Click Bell
448	Click
449	Indian 1
450	Indian 2
451	Indian 3
452	Indian 4
453	Indian 5
454	Indian 6
455	Indian 7
456	Indian 8
457	Indian 9
458	Indian 10
459	Indian 11
460	Indian 12
461	Indian 13
462	Indian 14
463	Indian 15
464	Indian 16
465	Indian 17
466	African 1
467	African 2
468	African 3
469	African 4
470	African 5
471	African 6
472	African 7
473	African 8
474	African 9
475	African 10
476	African 11
477	African 12
478	African 13
479	African 14
480	African 15
481	African 16
482	African 17
483	Marimba C3
484	Marimba D3
485	Marimba E3
486	Marimba F3
487	Marimba G3

# Drum Voice List

488	Marimba A3
489	Marimba B3
490	Marimba C4
491	Marimba D4
492	Marimba E4
493	Marimba F4
494	Marimba G4
495	Marimba A4
496	Marimba B4
497	Marimba C5
498	Marimba D5
499	Marimba E5
500	Marimba F5
501	Marimba G5
502	Marimba A5
503	Marimba B5
504	Marimba C6
505	Vibraphone C3
506	Vibraphone D3
507	Vibraphone E3
508	Vibraphone F3
509	Vibraphone G3
510	Vibraphone A3
511	Vibraphone B3
512	Vibraphone C4
513	Vibraphone D4
514	Vibraphone E4
515	Vibraphone F4
516	Vibraphone G4
517	Vibraphone A4
518	Vibraphone B4
519	Vibraphone C5
520	Vibraphone D5
521	Vibraphone E5
522	Vibraphone F5
523	Vibraphone G5
524	Vibraphone A5
525	Vibraphone B5
526	Vibraphone C6
527	Orchestra Timpani C2
528	Orchestra Timpani D2
529	Orchestra Timpani E2
530	Orchestra Timpani F2
531	Orchestra Timpani G2
532	Orchestra Timpani A2
533	Orchestra Timpani B2
534	Orchestra Timpani C3
535	Orchestra Timpani D3
<b>FX</b>	
536	FX 1
537	FX 2
538	FX 3
539	FX 4
540	FX 5
541	FX 6

542	FX 7
543	FX 8
544	FX 9
545	FX 10
546	FX 11
547	FX 12
548	FX 13
549	FX 14
550	FX 15
551	FX 16
552	FX 17
553	FX 18
554	FX 19
555	FX 20
556	FX 21
557	FX 22
558	FX 23
559	FX 24
560	FX 25
561	FX 26
562	FX 27
563	FX 28
564	FX 29
565	FX 30
566	FX 31
567	FX 32
568	FX 33
569	FX 34
570	FX 35
571	One & Stick
572	Two & Stick
573	Three & Stick
574	Four & Stick
575	Five & Stick
576	Six & Stick
577	Seven & Stick
578	Eight & Stick
579	Nine & Stick
580	Mute

HI-HAT Combination	
HH01	Standard
HH02	Rock
HH03	Acoustic
HH04	Funk
HH05	Brush
HH06	Jazz
HH07	808
HH08	909
HH09	Dance
HH10	Dubstep
HH11	Beatbox1
HH12	Beatbox2
HH13	Lo-Fi
HH14	Marimba
HH15	Vibra
HH16	Indian
HH17	African

# Song List

No.	Name	LCD Name
1	Funk1	Funk1
2	Rock N'Roll1	R'N'R1
3	Dance1	Dance1
4	Pop1	Pop1
5	Fusion1	Fusion1
6	R&B1	R&B1
7	Dubstep1	Dubstep1
8	R&B2	R&B2
9	Dubstep2	Dubstep2
10	Rock Ballad	RkBallad
11	Folk	Folk
12	Funk Shuffle	FunkShuf
13	Ele Pop1	ElePop1
14	Pop2	Pop2
15	Bossa Nova1	Bossa1
16	Samba1	Samba1
17	Fusion2	Fusion2
18	Ele Pop2	ElePop2
19	Pop Shuffle	PopShuff
20	Rock1	Rock1
21	Latin1	Latin1
22	Latin2	Latin2
23	Salsa1	Salsa1
24	Smoove	Smoove
25	Steve Vai Funk	SteveVfk
26	70's Funk	70'sFunk
27	Jazz1	Jazz1
28	6/8Soul1	6/8Soul1
29	Fusion3	Fusion3
30	Dance funk	Dancfunk
31	Dance2	Dance2
32	DJ.House	DJ.House
33	Ele Pop3	ElePop3
34	Hip Hop	HipHop
35	Pop3	Pop3
36	Pop4	Pop4
37	R&B3	R&B3
38	Reggae1	Reggae1
39	Rock2	Rock2
40	Rock3	Rock3
41	Blues Funk	BluesFnk
42	Fusion4	Fusion4
43	Cool Jazz	CoolJazz
44	Ballad	Ballad
45	Samba2	Samba2
46	Vintage Hip-Hop	VtHipHop
47	Nu Jazz Funk	NuJazzFk
48	Soul	Soul
49	R&B4	R&B4
50	Big Band 1	BigBand1

51	Ska	Ska
52	Classic Rock	ClassRk
53	Hardcore Hip-Hop	HcHipHop
54	Vintage Dance Pop	VtDcPop
55	Nu-Metal	Nu-Metal
56	Salsa2	Salsa2
57	Eu Hip-Hop	EuHipHop
58	Bossa Nova2	Bossa2
59	Fusion 5	Fusion5
60	8Beat Pop	8BeatPop
61	Jazzy Funk	JazzyFnk
62	Swing Big Band	SwBgBand
63	Raggae 2	Raggae2
64	60's Pop	60'sPop
65	Vintage Funk	VtgFunk
66	Trance	Trance
67	Heavy Rock	HeavyRk
68	Swing	Swing
69	Punk	Punk
70	8Beat	8Beat
71	Disco House	DiscoHs
72	3/4 Folk	3/4Folk
73	Samba3	Samba3
74	Latin Rock	LatinRk
75	Reggae 3	Reggae3
76	Dance3	Dance3
77	Country Pop	CtryPop
78	Country	Country
79	PopRock	PopRock
80	DancePop	DancePop



# GM Drum Kit List

No.	GM Percussion Kit	Rock Set(BANK0)	Standard Set(BANK8)	Funk Set(BANK16)	808 Set(BANK24)
Eb1[27]	High Q				
E 1[28]	Slap				
F 1[29]	Scratch Push				
F#1[30]	Scratch Pull				
G 1[31]	Sticks				
G#1[32]	Square Click				
A 1[33]	Metronome Click				
Bb1[34]	Metronome Bell				
B 1[35]	Acoustic Bass Drum				
C 2[36]	Bass Drum 1	Rock Kick	Standard Kick	Funk Kick	808 Kick
C#2[37]	Side Stick				
D 2[38]	Acoustic Snare	Rock Snare 1	Standard Snare 1	Funk Snare 1	808 Snare 1
Eb2[39]	Hand Clap				
E 2[40]	Electric Snare	Rock Snare 2	Standard Snare 2	Funk Snare 2	808 Snare 2
F 2[41]	Low Floor Tom	Rock Tom 4	Standard Tom 4	Funk Tom 4	808 Tom 4
F#2[42]	Closed Hi-hat	Rock Closed Hi-hat	Standard Closed Hi-hat	Funk Closed Hi-hat	808 Closed Hi-hat
G 2[43]	High Floor Tom	Rock Tom 3	Standard Tom 3	Funk Tom 3	808 Tom 3
G#2[44]	Pedal Hi-hat	Rock Pedal Hi-hat	Standard Pedal Hi-hat	Funk Pedal Hi-hat	808 Pedal Hi-hat
A 2[45]	Low Tom	Rock Tom 2	Standard Tom 2	Funk Tom 2	808 Tom 2
Bb2[46]	Open Hi-hat	Rock Open Hi-hat	Standard Open Hi-hat	Funk Open Hi-hat	808 Open Hi-hat
B 2[47]	Low-Mid Tom				
C 3[48]	High Mid Tom	Rock Tom 1	Standard Tom 1	Funk Tom 1	808 Tom 1
C#3[49]	Crash Cymbal 1	Rock Crash 1	Standard Crash 1	Funk Crash 1	808 Crash 1
D 3[50]	High Tom 1				
Eb3[51]	Ride Cymbal 1	Rock Ride	Standard Ride	Funk Ride	808 Ride
E 3[52]	China Cymbal				
F 3[53]	Ride Bell	Rock Ride Bell	Standard Ride Bell	Funk Ride Bell	808 Ride Bell
F#3[54]	Tambourine				
G 3[55]	Splash Cymbal				
G#3[56]	Cowbell				
A 3[57]	Crash Cymbal 2	Rock Crash 2	Standard Crash 2	Funk Crash 2	808 Crash 2
Bb3[58]	Vibra-slap				
B 3[59]	Ride Cymbal 2				
C 4[60]	High Bongo				
C#4[61]	Low Bongo				
D 4[62]	Mute Hi Conga				
Eb4[63]	Open Hi Conga				
E 4[64]	Low Conga				
F 4[65]	High Timbale				
F#4[66]	Low Timbale				
G 4[67]	High Agogo				
G#4[68]	Low Agogo				
A 4[69]	Cabasa				
Bb4[70]	Maracas				
B 4[71]	Short Whistle				
C 5[72]	Long Whistle				
C#5[73]	Short Guiro				
D 5[74]	Long Guiro				
Eb5[75]	Claves				
E 5[76]	Hi Wood Block				
F 5[77]	LowWood Block				
F#5[78]	Mute Cuica				
G 5[79]	Open Cuica				
G#5[80]	Mute Triangle				
A 5[81]	Open Triangle				
Bb5[82]	Shaker				
B 5[83]	Jingle Bell				
C 6[84]	Bell Tree				
C#6[85]	Castanets				
D 6[86]	Mute Surdo				
Eb6[87]	Open Surdo				

# GM Drum Kit List

No.	909 Set(BANK25)	Acoustic Set(BANK32)	Brush Set(BANK40)	Dupstep1 Set(BANK48)	Dupstep2 Set(BANK56)
Eb1[27]					
E 1[28]					
F 1[29]					
F#1[30]					
G 1[31]					
G#1[32]					
A 1[33]					
Bb1[34]					
B 1[35]					
C 2[36]	909 Kick	Acoustic Kick	Brush Kick	Dupstep1 Kick	Dupstep2 Kick
C#2[37]					
D 2[38]	909 Snare 1	Acoustic Snare 1	Brush Snare 1	Dupstep1 Snare 1	Dupstep2 Snare 1
Eb2[39]					
E 2[40]	909 Snare 2	Acoustic Snare 2	Brush Snare 2	Dupstep1 Snare 2	Dupstep2 Snare 2
F 2[41]	909 Tom 4	Acoustic Tom 4	Brush Tom 4	Dupstep1 Tom 4	Dupstep2 Tom 4
F#2[42]	909 Closed Hi-hat	Acoustic Closed Hi-hat	Brush Closed Hi-hat	Dupstep1 Closed Hi-hat	Dupstep2 Closed Hi-hat
G 2[43]	909 Tom 3	Acoustic Tom 3	Brush Tom 3	Dupstep1 Tom 3	Dupstep2 Tom 3
G#2[44]	909 Pedal Hi-hat	Acoustic Pedal Hi-hat	Brush Pedal Hi-hat	Dupstep1 Pedal Hi-hat	Dupstep2 Pedal Hi-hat
A 2[45]	909 Tom 2	Acoustic Tom 2	Brush Tom 2	Dupstep1 Tom 2	Dupstep2 Tom 2
Bb2[46]	909 Open Hi-hat	Acoustic Open Hi-hat	Brush Open Hi-hat	Dupstep1 Open Hi-hat	Dupstep2 Open Hi-hat
B 2[47]					
C 3[48]	909 Tom 1	Acoustic Tom 1	Brush Tom 1	Dupstep1 Tom 1	Dupstep2 Tom 1
C#3[49]	909 Crash 1	Acoustic Crash 1	Brush Crash 1	Dupstep1 Crash 1	Dupstep2 Crash 1
D 3[50]					
Eb3[51]	909 Ride	Acoustic Ride	Brush Ride	Dupstep1 Ride	Dupstep2 Ride
E 3[52]					
F 3[53]	909 Ride Bell	Acoustic Ride Bell	Brush Ride Bell	Dupstep1 Ride Bell	Dupstep2 Ride Bell
F#3[54]					
G 3[55]					
G#3[56]					
A 3[57]	909 Crash 2	Acoustic Crash 2	Brush Crash 2	Dupstep1 Crash 2	Dupstep2 Crash 2
Bb3[58]					
B 3[59]					
C 4[60]					
C#4[61]					
D 4[62]					
Eb4[63]					
E 4[64]					
F 4[65]					
F#4[66]					
G 4[67]					
G#4[68]					
A 4[69]					
Bb4[70]					
B 4[71]					
C 5[72]					
C#5[73]					
D 5[74]					
Eb5[75]					
E 5[76]					
F 5[77]					
F#5[78]					
G 5[79]					
G#5[80]					
A 5[81]					
Bb5[82]					
B 5[83]					
C 6[84]					
C#6[85]					
D 6[86]					
Eb6[87]					

# GM Backing Voice List

PIANO		BASS		BRASS		PAD	
1	Acoustic Grand Piano	33	Acoustic Bass	57	Trumpet	89	Pad1 (newage)
2	Bright Acoustic Piano	34	Finger Bass	58	Trombone	90	Pad2 (warm)
3	Electric Grand Piano	35	Pick Bass	59	Tuba	91	Pad3 (polysynth)
4	Honky-Tonk Piano	36	Fretless Bass	60	Muted Trumpet	92	Pad4 (choir)
5	E.Piano 1	37	Slap Bass 1	61	French Horn	93	Pad5 (bowed)
6	E.Piano 2	38	Slap Bass 2	62	Brass Section	94	Pad6 (metallic)
7	Harpichord	39	Synth Bass 1	63	Synth Brass 1	95	Pad7 (halo)
8	Clavi	40	Synth Bass 2	64	Synth Brass 2	96	Pad8 (sweep)
MALLET		SOUNDEFFECTS		REED		EFFECTS	
9	Celesta	121	Guitar Fret Noise	65	Soprano Sax	97	FX1 (rain)
10	Glockenspiel	122	Breath Noise	66	Alto Sax	98	FX2 (soundtrack)
11	Music Box	123	Seashore	67	Tenor Sax	99	FX3 (crystal)
12	Vibraphone	124	Bird Tweet	68	Baritone Sax	100	FX4 (atmosphere)
13	Marimba	125	Telephone Ring	69	Oboe	101	FX5 (brightness)
14	Xylophone	126	Helicopter	70	English Horn	102	FX6 (goblins)
15	Tubular Bells	127	Applause	71	Bassoon	103	FX7 (echoes)
16	Dulcimer	128	Gunshot	72	Clarinet	104	FX8 (sci-fi)
ORGAN		STRINGS		PIPE		ETHNIC	
17	Drawbar Organ	41	Violin	73	Piccolo	105	Sitar
18	Percussive Organ	42	Viola	74	Flute	106	Banjo
19	Rock Organ	43	Cello	75	Recorder	107	Shamisen
20	Church Organ	44	Contrabass	76	Pan Flute	108	Koto
21	Reed Organ	45	Tremolo Strings	77	Blown Bottle	109	Kalimba
22	Accordion	46	Pizzicato Strings	78	Shakuhachi	110	Bagpipe
23	Harmonica	47	Orchestral Harp	79	Whistle	111	Fiddle
24	Tango Accordion	48	Timpani	80	Ocarina	112	Shanai
GUITAR		STRINGSENSEMBLE		LEAD		PERCUSSIVE	
25	Nylon Guitar	49	Strings Ensemble 1	81	Lead1 (square)	113	Tinkle Bell
26	Steel Guitar	50	Strings Ensemble 2	82	Lead2 (sawtooth)	114	Agogo
27	Jazz Guitar	51	Synth Strings 1	83	Lead3 (calliope)	115	Steel Drums
28	Clean Guitar	52	Synth Strings 2	84	Lead4 (cliff)	116	Wood Block
29	Muted Guitar	53	Choir Aahs	85	Lead5 (charang)	117	Taiko Drum
30	Overdriven Guitar	54	Voice Oohs	86	Lead6 (voice)	118	Melodic Tom
31	Distortion Guitar	55	Synth Voice	87	Lead7 (fifths)	119	Synth Drum
32	Guitar Harmonics	56	Orchestra Hit	88	Lead8 (bass & lead)	120	Reverse Cymbal

# MIDI Implementation Chart

Function...		Transmitted	Recognized	Remarks
Basic Channel	Default Changed	10ch x	1 – 16 x	
Mode	Default Messages Altered	x x *****	x x *****	
Note Number:	True voice	0 – 127 *****	0 – 127 0 – 127	
Velocity	Note on Note off	○ 99H,V=1-127 ○ (99H,V=0)	○ ○	
After Touch	Key's Channel's	x x	○ x	
Pitch Bend		x	○	
Control Change	0 1 5 6 7 10 11 64 65 66 67 80 81 91 93 120 121 123	x x x x x x x x x x x x x x x x x	○ ○ ○ ○ ○ ○ ○ ○ ○ ○ ○ ○ ○ ○ ○ ○ ○	Bank Select Modulation Portamento Time Data Entry Volume Pan Expression Sustain Pedal Portamento ON/OFF Sostenuto Pedal Soft Pedal Reverb Program Chorus Program Reverb Level Chorus Level All Sound Off Reset All Controllers All Notes Off
Program Change	: True #	○ xxxxxxx	○ 0 – 127	
System Common	Exclusive : Song Position : Song Select : Tune	x x x x	○ x x x	
System Real Time	: Clock : Commands	○ ○	x x	START and STOP only
Aux Messages	: Local ON/OFF : All Notes OFF : Active Sense : Reset	x x x x	x x x x	

O : YES X : NO

# Prompt Messages

No.	LCD Message	Description
<b>Notification/Warning</b>		
1	Name invalid!	(Rename) File name is invalid. Input at least one character for file name.
2	Characters too long!	(Rename) The number of characters exceeds the limit. Decrease the number.
3	The 1st character can't be a SPACE!	(Rename) Make sure the 1st character is not a blank space.
4	Duplicate name !	(Rename) File name already exists. Input a different name.
5	Save ok!	Saving is successful.
6	Save failed!	Saving is failed.
7	Reset ok!	Factory reset is successful.
8	Waiting	Please wait patiently.
9	Record memory full!	The memory of MIDI recording is full.
10	Can't edit in iKit mode!	Parameters are not editable in iKit mode.
11	Unsupported record under iKit mode!	MIDI recording is not supported in iKit mode.
<b>Inquiry/Confirmation</b>		
12	Reset user kit data?	Confirm to delete all user kit data.
13	Reset user song data?	Confirm to delete all user song data.
14	Reset user trigger data?	Confirm to reset user trigger to factory default.
15	Reset user all data?	Confirm to reset all user data and settings to factory default.

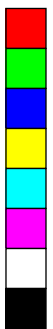

DD635D\_G01

