

CT-S200 Casiotone

EN

USER'S GUIDE



Preparing a Power Supply



Turning Power On or Off



Connecting Headphones
(Sold Separately)



Connecting a Pedal
(Sold Separately)



Selecting a Musical
Instrument Tone



Changing the Pitch in
Semitone Steps (Transpose)



Fine Tuning Pitch (Tuning)



Using the SUSTAIN Button



Saving and Loading
Instrument Settings
(MY SETUP)



Playing a Built-in Song



Playing in the Dance Music
Mode



Using a Dance Music Voice



Playing with a Rhythm
Backing



Linking with a Smart Device
(APP Function)



Configuring Function Settings

Included and Optional Accessories

Use only accessories that are specified for use with this Digital Keyboard.

Use of unauthorized accessories creates the risk of fire, electric shock, and personal injury.



- You can get information about accessories that are sold separately for this product from the CASIO catalog available from your retailer, and from the CASIO website at the URL or QR code below.

<https://support.casio.com/global/en/emi/manual/CT-S200/>



About Music Score data

You can download music score data as a PDF file from the CASIO website, which you can access using the URL or QR code below. You will then be able to view music scores on your smart device. You can jump from the PDF file table of contents directly to the music score you want, and you can print out scores as needed.

<https://support.casio.com/global/en/emi/manual/CT-S200/>



- Any reproduction of the contents of this manual, either in part or its entirety, is prohibited. Except for your own, personal use, any other use of the contents of this manual without the consent of CASIO is prohibited under copyright laws.
- IN NO EVENT SHALL CASIO BE LIABLE FOR ANY DAMAGES WHATSOEVER (INCLUDING, WITHOUT LIMITATION, DAMAGES FOR LOSS OF PROFITS, BUSINESS INTERRUPTION, LOSS OF INFORMATION) ARISING OUT OF THE USE OF OR INABILITY TO USE THIS MANUAL OR PRODUCT, EVEN IF CASIO HAS BEEN ADVISED OF THE POSSIBILITY OF SUCH DAMAGES.
- The contents of this manual are subject to change without notice.
- The actual appearance of the product may be different from that shown in the illustrations in this User's Guide.
- Company and product names used in this manual may be registered trademarks of others.

Contents

General Guide	EN-3
Getting Ready to Play	EN-4
Preparing a Power Supply	EN-4
Preparing the Music Stand	EN-5
Connecting Headphones (Sold Separately)	EN-6
Connecting a Pedal (Sold Separately)	EN-6
Operations Common to All Modes	EN-6
Display Screen Contents	EN-6
HOME Button	EN-6
3 Buttons	EN-7
Dial Operations	EN-7
Playing on the Keyboard	EN-7
Turning Power On or Off	EN-7
Adjusting the Volume Level	EN-8
Using the Metronome	EN-9
Listening to Demo Play	EN-10
Controlling the Sound of a Performance	EN-10
Selecting a Musical Instrument Tone	EN-10
Using a Pedal	EN-11
Using the SUSTAIN Button	EN-11
Adding Reverb to Notes	EN-11
Changing the Pitch in Semitone Steps (Transpose)	EN-12
Fine Tuning Pitch (Tuning)	EN-12
Saving and Loading Instrument Settings (MY SETUP)	EN-13
Saving to MY SETUP	EN-13
Recalling From MY SETUP	EN-14
Playing a Built-in Song	EN-15
Songs	EN-15
Selecting a Song to Play	EN-15
Assigning the Song Tone to the Keyboard (Tone Sync)	EN-17
Practicing a Song Part	EN-17
Sounding a Count in Time with a Song	EN-18
Playing in the Dance Music Mode	EN-19
Dance Music Mode	EN-19
Playing Dance Music	EN-20
Using the Recommended Tone	EN-22
Using a Dance Music Voice	EN-22
Using Effects	EN-22
Building Performance Tension	EN-23

Playing with a Rhythm Backing	EN-23
Rhythm	EN-23
Playing a Rhythm	EN-23
Using Recommended Rhythm Settings	EN-25
Changing the Rhythm Pattern	EN-25
Inserting a Fill-in Phrase	EN-26
Fingering a Chord to Play a Rhythm Accompaniment	EN-26
Inserting an Intro or an Ending	EN-28
Connecting with External Devices	EN-29
Linking with a Smart Device (APP Function)	EN-29
Connecting to a computer and Using MIDI	EN-30
Connecting with Audio Equipment	EN-31
Configuring Function Settings	EN-32
Configuring Settings	EN-32
Setting Item List	EN-32
Reference	EN-35
Troubleshooting	EN-35
Product Specifications	EN-36
Tone List	EN-39
Drum Assignment List	EN-42
Song List	EN-43
Dance Music Mode List	EN-43
Rhythm List	EN-44
Fingering Guide	EN-45
Chord Example List	EN-46

MIDI Implementation Chart

General Guide

■ Front Panel

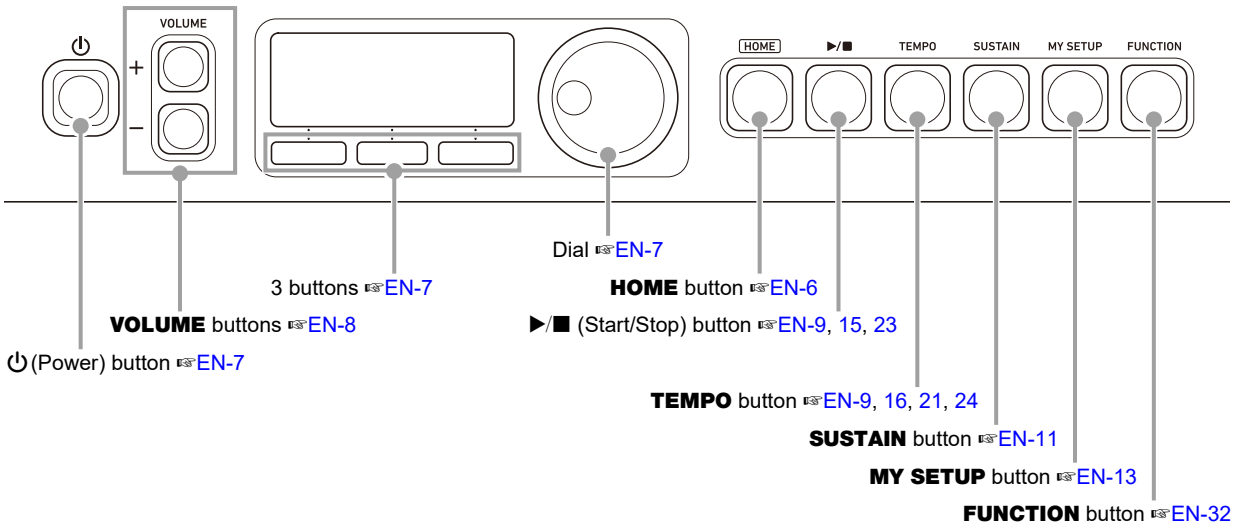

■ Back

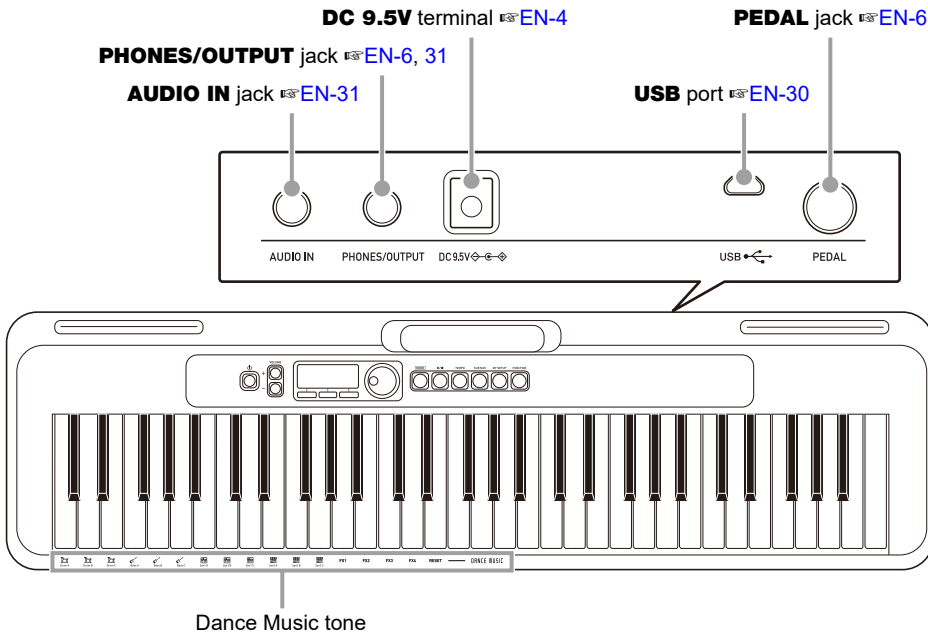

- The numbers to the right of the EN symbol are reference page numbers.

Getting Ready to Play

Preparing a Power Supply

Though either an AC adaptor or batteries can be used for power, use of AC adaptor power is normally recommended.

Using the AC Adaptor

Use only the AC adaptor (JEITA Standard with unified polarity plug) specified for this Digital Keyboard. Use of a different type of AC adaptor can cause malfunction.

AC Adaptor Type: AD-E95100L
(JEITA Standard plug)

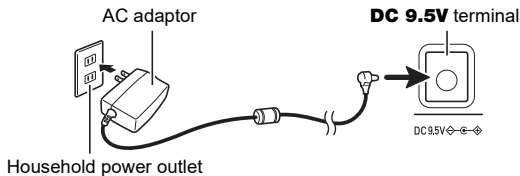

IMPORTANT!

- Be sure to turn off Digital Keyboard power before connecting or disconnecting the AC adaptor.
- The AC adaptor becomes warm to the touch after very long use. This is normal and does not indicate malfunction.
- To prevent breaking of the wire, take care to avoid putting any type of load on the power cord.

No twisting



No pulling

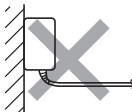

No wrapping



- Never insert metal, pencils, or any other objects into the DC 9.5V terminal. Doing so creates the risk of accident.

Using Batteries for Power

IMPORTANT!

- Be sure to turn off power before loading batteries.
- Use commercially available AA-size alkaline batteries or AA-size rechargeable nickel metal hydride batteries.
- Low battery power can cause abnormal operation. If this happens, replace batteries with new ones. If you are using rechargeable batteries, charge them.

Batteries

Note the precautions below when using rechargeable batteries.

- Use Panasonic Group AA-size eneloop rechargeable batteries. Do not use any other type of batteries.
- Use only the specified charger to charge batteries.
- Rechargeable batteries must be removed from the product for charging.
- For information about using eneloop batteries or their specified charger, be sure to read the user documentation and precautions that come with each item, and use them only as directed.

Be sure to replace batteries at least once a year, even if there is no indication of low battery power. Dead rechargeable batteries (eneloop) in particular may deteriorate if they are left in the product. Remove rechargeable batteries from the product as soon as possible after they go dead.

1. Open the battery cover on the back of the Digital Keyboard.

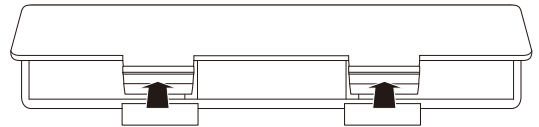

2. Load six AA-size batteries into the battery compartment.

Load batteries with their positive (+) and negative (-) ends facing correctly.

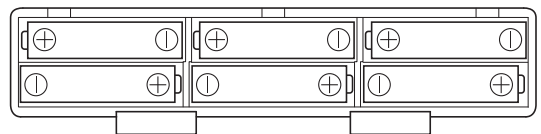

3. Insert the tabs of the battery cover into the holes, and close the cover.

- Configure the setting below to specify the type of batteries you loaded.

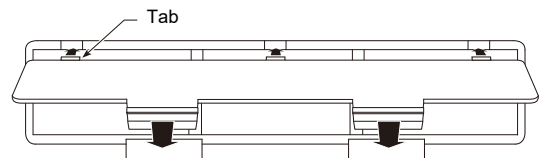

■ Configuring the Battery Type Setting

1. Press **FUNCTION**.

This displays the [FUNCTION] screen.

2. Use the **<** and **>** buttons to select “Battery”.

- To go back to the previous screen, press the EXIT button.

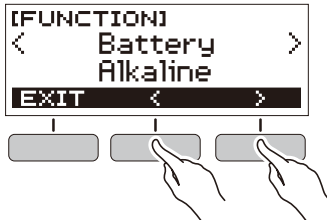

3. Rotate the dial to select “Alkaline” (alkaline batteries) or “Ni-MH” (rechargeable nickel metal hydride batteries).

- After you rotate the dial once to select an option, you also will be able to change the selection using the – and + buttons.
- To go back to the previous screen, press the BACK button.



4. Press **FUNCTION** to exit the setting screen.

■ Battery Level Indicator

A battery icon appears on the display as shown below to let you know when battery power is getting low.

Low Battery Power

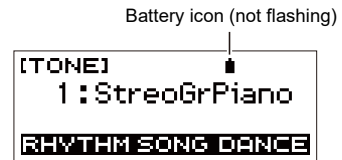

Battery Replacement Required

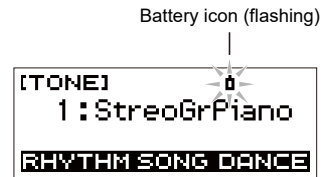

NOTE

- Low battery power may cause notes to become distorted, or other problems.
- You can conserve battery power by using headphones and by reducing the volume level.

Preparing the Music Stand

Insert the music stand into the handle of the Digital Keyboard.

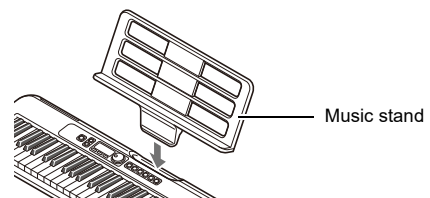

Connecting Headphones (Sold Separately)

Plugging in headphones cuts off output from the built-in speakers, which means you can practice playing even late at night without disturbing others.

- Be sure to turn down the Digital Keyboard volume level before connecting headphones.

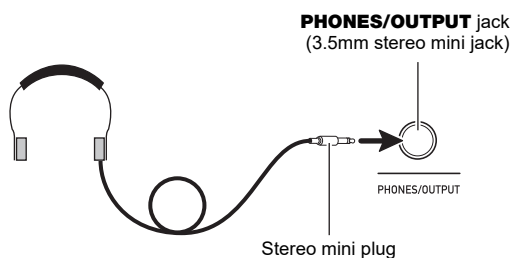

NOTE

- Headphones do not come with the Digital Keyboard.
- Use separately sold or commercially available headphones.

IMPORTANT!

- Do not listen to output over headphones at very high volume levels for long periods. Doing so creates the risk of hearing damage.
- If the plug of the headphones does not match the **PHONES/OUTPUT** jack, use a commercially available adapter plug.
- If you are using headphones that require an adapter plug, make sure you do not leave the adapter plugged in when removing the headphones.

Connecting a Pedal (Sold Separately)

To use a pedal, connect it to the **PEDAL** jack.

PEDAL jack (6.3mm standard jack)

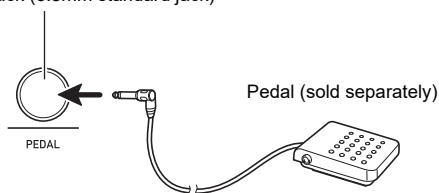

Operations Common to All Modes

Display Screen Contents

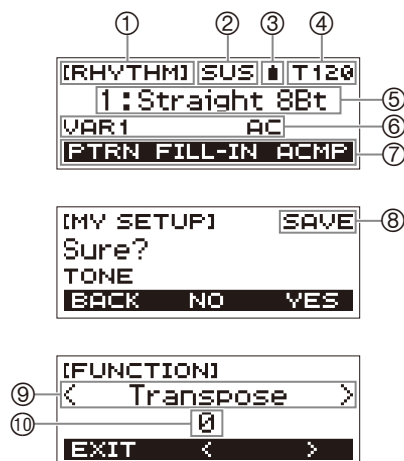

- ① Function name
- ② Sustain
- ③ Battery icon
- ④ Tempo
- ⑤ Current setting
- ⑥ Status
- ⑦ 3 button functions
- ⑧ Sub-function name
- ⑨ Setting item
- ⑩ Current setting

For information about how to adjust display contrast, see “[Configuring Function Settings](#)” (page EN-32).

HOME Button

Pressing **HOME** will display the [TONE] screen, which you can use to select a tone. This is the home screen. You can use the home screen to select the instrument type and to configure various settings.

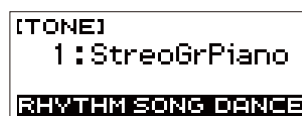

3 Buttons

Operations assigned to the three buttons along the bottom of the display change according to the setting you are configuring. Operations currently assigned to the three buttons are indicated by labels above the buttons.

3 Button Examples

■ Home Screen (Tone Selection Screen)

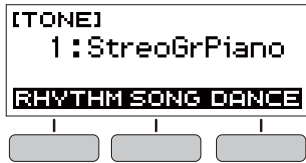

■ Setting Screen



- Holding down the – or + button when selecting a number or value will scroll through settings at high speed.
- To return a number or value to its initial default or recommended setting, press the – and + buttons at the same time.

Dial Operations

Rotate the dial to change a number (tone number, etc.) or value (tempo value, etc.)

Playing on the Keyboard

Turning Power On or Off

1. Press (Power).

This turns on power.

- To turn off power, hold down  (Power) until the display goes blank.

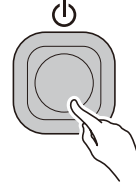

2. Play something on the keyboard.

IMPORTANT!

- Turning off power normally causes the tone and rhythm number and other settings to return to their initial defaults. However, the settings below are remembered.
 - MIDI Out Channel
 - MIDI Out Octave Shift
 - MIDI Out Velocity
 - Startup volume level
 - MY SETUP Startup
 - Auto Power Off
 - Battery type
 - LCD contrast

Auto Power Off

While Auto Power Off is enabled, Digital Keyboard power will turn off automatically after about 30 minutes of non-operation.

NOTE

- Auto Power Off is disabled while a song is playing and while the APP function is being used.

Disabling Auto Power Off

You can disable Auto Power Off to ensure that power does not turn off automatically during a concert, etc.

1. Press **FUNCTION**.

This displays the [FUNCTION] screen.

2. Use the < and > buttons to select “Auto Power Off”.

- To go back to the previous screen, press the EXIT button.

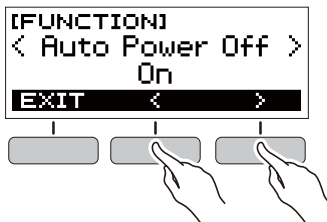

3. Rotate the dial to the left to select “Off”.

- After you rotate the dial once to select an option, you also will be able to change the selection using the – and + buttons.
- To go back to the previous screen, press the BACK button.



4. Press **FUNCTION** to exit the setting screen.

Adjusting the Volume Level

1. Use the **VOLUME +** and **–** buttons to adjust the volume level.

This will change the volume level and cause the current volume level value to appear momentarily on the display.

- The setting range is 0 to 10.
- Holding down either button scrolls the setting value.

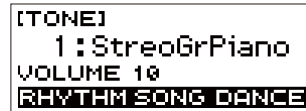

Specifying the Power On Volume Level

You can use the procedure below to specify the volume level that is applied when the Digital Keyboard is turned on.

1. Press **FUNCTION**.

This displays the [FUNCTION] screen.

2. Use the < and > buttons to select “PowerOnVolume”.

- To go back to the previous screen, press the EXIT button.

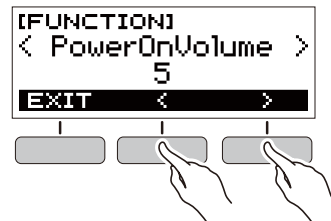

3. Rotate the dial to select the volume level.

- After you rotate the dial once to select an option, you also will be able to change the selection using the – and + buttons.
- To go back to the previous screen, press the BACK button.

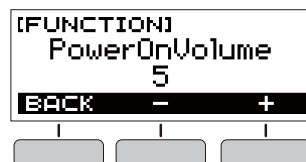

4. Press **FUNCTION** to exit the setting screen.

Using the Metronome

The metronome lets you play and practice along with a steady beat to help keep you on tempo. You can also set a tempo that is suitable for your practice.

Start/Stop

1. Press **HOME**.
This displays the home screen.
2. Press **▶/■**.
This starts the metronome.

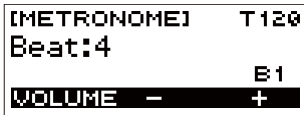

3. Press **▶/■** again to stop the metronome and return to the home screen.

Changing the Metronome Tempo

Use the procedure below to change the tempo of the metronome.

1. Start the metronome.
2. Press **TEMPO**.
This displays the [TEMPO] screen.



3. Rotate the dial or use the **-** and **+** buttons to change the tempo value.
 - You can specify a tempo value in the range of 20 to 255.
 - To return the setting to its initial default, press the **-** and **+** buttons at the same time.
 - To return to the [METRONOME] screen, press the EXIT button.

Specifying the Metronome Sound and Beats Per Measure

You can use the procedure below to configure a setting that sounds a chime on the first beat of each measure, and a click for the remaining beats.

- Available settings are Off, or a value of 1 to 16 beats.
1. Start the metronome.
 2. Rotate the dial or use the **-** and **+** buttons to specify the number of beats per measure.
 - Selecting "Off" disables the chime and sounds a click for all beats. Use this setting when you want to practice without worrying about the first beat of each measure.
 - To return the setting to its initial default, press the **-** and **+** buttons at the same time.
 - To display the metronome volume level setting screen, press VOLUME (3 buttons).



Changing the Metronome Sound Volume Level

1. Start the metronome.
2. Press **VOLUME** (3 buttons).

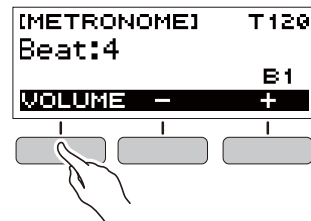

This displays the metronome volume level setting screen.



3. Rotate the dial or use the **-** and **+** buttons to change the volume value.
 - You can specify a volume value from 0 to 127.
 - To return the setting to its initial default, press the **-** and **+** buttons at the same time.
 - To display the beat setting screen, press the BEAT button.

Listening to Demo Play

You can use Demo Play to play built-in songs in sequence.

1. While holding down **TEMPO**, press **▶/■**.

This displays the [DEMO] screen and starts song number "1".

- The display shows the number and name of the current song.
- For a list of song titles, see the "Song List" (page EN-43).
- To return to the home screen, press the EXIT button.



2. To change from the current song to another one, rotate the dial.

This starts Demo Play of the song you selected.

- After you rotate the dial once to select an option, you also will be able to change the selection using the – and + buttons.
- To go back to the previous screen, press the BACK button.

3. To exit Demo Play, press the **EXIT** button or **▶/■**.

Controlling the Sound of a Performance

Selecting a Musical Instrument Tone

Your Digital Keyboard lets you select tones for a wide variety of musical instrument sounds, including violin, flute, orchestra, and more. Even the same song sounds different when the instrument type is changed.

Selecting an Instrument Tone for Keyboard Play

1. Press **HOME**.

This displays the home screen.

2. Rotate the dial to select a tone.

The selected tone number and instrument name will appear on the display.

- For tone information, see the "Tone List" (page EN-39).
- After you rotate the dial once to select an option, you also will be able to change the selection using the – and + buttons.
- To return to the first tone in the tone list, press – and + at the same time.
- To go back to the previous screen, press the BACK button.



NOTE

- Selecting a drum set tone causes various percussion instruments to be assigned to keyboard keys.

Using a Pedal

A pedal can be used to change notes while playing. Under initial default settings, sustain is assigned to the pedal, so it can be used as a damper pedal.

- A pedal unit does not come with the Digital Keyboard. Purchase one separately from your retailer.

Selecting the Pedal Effect

1. Press **FUNCTION**.

This displays the [FUNCTION] screen.

2. Use the **<** and **>** buttons to select “Pedal”.

- To go back to the previous screen, press the EXIT button.

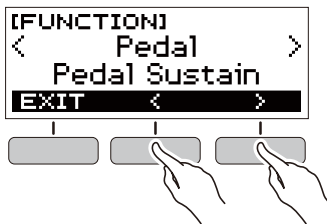

3. Rotate the dial to select a pedal effect type.

The following shows the available pedal effects.

Setting (Display Text)	Description
Pedal Sustain (Pedal Sustain)	Playing notes while the pedal is depressed causes the notes to be sustained, even if the keyboard keys are released.
Sostenuto (Sostenuto)	Playing notes and then pressing the pedal before the keyboard keys are released causes the notes to be sustained.
Soft (Soft)	Pressing the pedal and playing notes causes the notes to be slightly softened.
Start/Stop (Start/Stop)	The pedal has the same functions as the ►/■ button. It can be used to start and stop the metronome or rhythm play.

- After you rotate the dial once to select an option, you also will be able to change the selection using the – and + buttons.
- To return the setting to its initial default, press the – and + buttons at the same time.
- To go back to the previous screen, press the BACK button.

Using the SUSTAIN Button

While sustain is enabled, notes are sustained longer when keyboard keys are released.

1. Press **SUSTAIN**.

This momentarily displays “SUSTAIN ON”.

- “SUS” at the top of the display indicates that sustain is enabled.

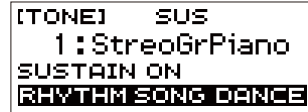

2. To disable sustain, press **SUSTAIN** again.

Adding Reverb to Notes

You can use the procedure below to add reverb to the notes you play.

1. Press **FUNCTION**.

This displays the [FUNCTION] screen.

2. Use the **<** and **>** buttons to select “Reverb”.

- To go back to the previous screen, press the EXIT button.

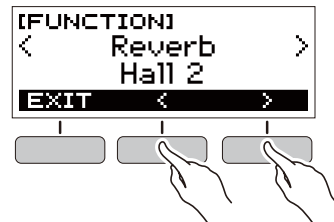

3. Rotate the dial to select the reverb type.

Available reverb type settings are: Off, Room 1 to 4, Hall 1 to 4, and Stadium 1 and 2.

- After you rotate the dial once to select an option, you also will be able to change the selection using the – and + buttons.
- To return the setting to its initial default, press the – and + buttons at the same time.
- To go back to the previous screen, press the BACK button.



Changing the Pitch in Semitone Steps (Transpose)

Transpose lets you raise or lower the overall pitch of the Digital Keyboard in semitone steps. You can use this feature to raise or lower the Digital Keyboard's key to make it easier to play a piece written in a difficult key, or to adjust to a key that better matches a vocalist, another musical instrument, etc.

1. Press **FUNCTION**.

This displays the [FUNCTION] screen.

2. Use the **<** and **>** buttons to select "Transpose".

- To go back to the previous screen, press the EXIT button.

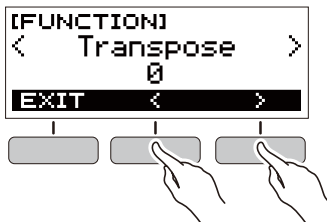

3. Rotate the dial to change the transpose value.

- The setting range is one octave up (+12 semitones) and down (-12 semitones).
- After you rotate the dial once to select an option, you also will be able to change the selection using the - and + buttons.
- To return the setting to its initial default, press the - and + buttons at the same time.
- To go back to the previous screen, press the BACK button.



Fine Tuning Pitch (Tuning)

You can use the procedure below to adjust the overall pitch of the Digital Keyboard by changing the frequency of A4 in 0.1Hz units.

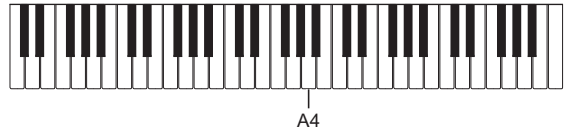

1. Press **FUNCTION**.

This displays the [FUNCTION] screen.

2. Use the **<** and **>** buttons to select "Tuning".

- To go back to the previous screen, press the EXIT button.

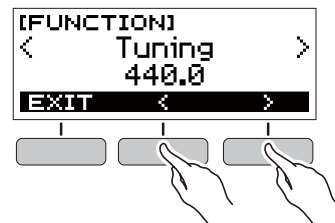

3. Rotate the dial to fine tune the pitch.

- You can specify a frequency in the range of 415.5 to 465.9 Hz.
- After you rotate the dial once to select an option, you also will be able to change the selection using the - and + buttons.
- To return the setting to its initial default, press the - and + buttons at the same time.
- To go back to the previous screen, press the BACK button.



Saving and Loading Instrument Settings (MY SETUP)

You can use MY SETUP to save the setup (tone, rhythm, and other settings) of the Digital Keyboard. You can recall a saved setup when you need it to perform a particular song, etc.

Saving to MY SETUP

1. Press MY SETUP.

This displays the [MY SETUP] screen.

2. Press the SAVE button.

This causes "Sure?" to appear on the display. The name of the main setting (TONE, RHYTHM, SONG, DANCE MUSIC) also appears.

- To go back to the previous screen, press the BACK button.



3. Press the YES button.

This saves the current setup to MY SETUP.

4. When "Complete" appears on the display, press the OK button.

This completes the save operation.

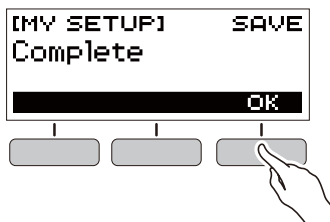

Savable Settings

You can use MY SETUP to save the items below.

- The function you are using (Tone, Rhythm, Song, Dance Music)
- Tempo
- Tone number
- Metronome beat
- Metronome volume level
- Sustain
- Rhythm number
- Patterns
- FILL-IN
- Accomp
- Song number
- Practice part
- Count
- Tone sync
- Dance Music number
- Dance Music voice
- Transpose
- Reverb
- Pedal
- Intro/Ending
- Chord fingering mode
- Rhythm volume level
- Song volume level
- Dance Music volume level
- Tuning

NOTE

- If tone sync is enabled when you save settings with MY SETUP, recalling from MY SETUP will apply the tone sync reverb setting, even if you changed the reverb setting to something else before saving to MY SETUP.

Recalling From MY SETUP

1. Press **MY SETUP**.

This displays the [MY SETUP] screen.

2. Press the **LOAD** button.

This causes "Sure?" to appear on the display. The name of the main setting (TONE, RHYTHM, SONG, DANCE MUSIC) also appears.

- To go back to the previous screen, press the **BACK** button.



3. Press the **YES** button.

This recalls the saved settings.

4. When "Complete" appears on the display, press the **OK** button.

This completes the recall operation.

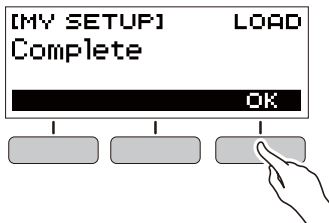

Enabling MY SETUP Power On

Use the procedure below to enable MY SETUP power on, which causes the MY SETUP settings to be applied whenever the Digital Keyboard is turned on.

1. Press **FUNCTION**.

This displays the [FUNCTION] screen.

2. Use the **<** and **>** buttons to select "PowerOnMySetup".

- To go back to the previous screen, press the **EXIT** button.

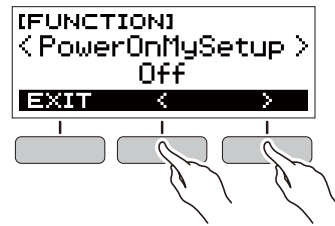

3. Rotate the dial to the right to select "On".

- After you rotate the dial once to select an option, you also will be able to change the selection using the – and + buttons.
- To go back to the previous screen, press the **BACK** button.



4. Press **FUNCTION** to exit the setting screen.

Playing a Built-in Song

Songs

With this Digital Keyboard, the term “song” is used to refer to a musical piece. You can listen to the built-in songs for your own enjoyment, or you can play along with them for practice.

Selecting a Song to Play

Starting or Stopping Song Play

1. Press **HOME**.

This displays the home screen.

2. Press the **SONG** button.

This displays the currently selected song number and song title.



3. Rotate the dial to select a song.

- After you rotate the dial once to select an option, you also will be able to change the selection using the – and + buttons.
- To go back to the previous screen, press the **BACK** button.



4. Press **▶/■** to start the song.

This causes the current measure number and beat number to appear on the display.

- If the song includes chord information, a chord will also appear on the display.



5. To stop the song, press **▶/■** again.



NOTE

- Displaying the [SONG] screen while the metronome is sounding or a rhythm or Dance Music is playing will cause the ongoing operation to stop.

Skip Forward and Skip Back

Use the operations in this section to perform skip forward and skip back operations.

■ Skip Forward

While a song is playing, press the FF button to skip forward.

- Pressing the FF button once skips forward one measure, while holding it down skips forward until it is released.

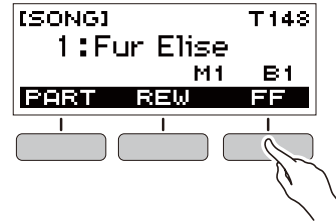

■ Skip Back

While a song is playing, press the REW button to skip back.

- Pressing the REW button once skips back one measure, while holding it down skips back until it is released.

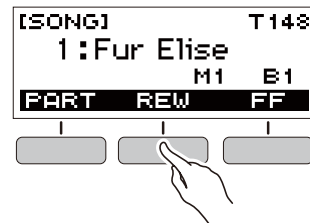

Changing a Song's Tempo (Speed)

You can use the procedure below to change the tempo (speed) and slow down playback to practice difficult passages, etc.

1. While the [SONG] screen is displayed, select the song whose tempo you want to change and then press **TEMPO**.

This displays the [TEMPO] screen.

2. Rotate the dial to change the tempo setting.

- You can specify a tempo value in the range of 20 to 255.
- You can also use the – and + buttons to change the setting. Press the – button to make the tempo slower or the + button to make it faster. Holding down either button scrolls the setting value.
- To return to the recommended setting for the current song, press – and + at the same time.
- Changing the song number will also return the song to its recommended tempo.
- To go back to the previous screen, press the EXIT button.



Adjusting the Song Volume Level

Use the procedure below to adjust the balance between the volume levels of song play and what you play on the keyboard.

1. Press **FUNCTION**.

This displays the [FUNCTION] screen.

2. Use the < and > buttons to select “Song Volume”.

- To go back to the previous screen, press the EXIT button.



3. Rotate the dial to adjust the volume level.

- You can specify a volume value from 0 to 127.
- After you rotate the dial once to select an option, you also will be able to change the selection using the – and + buttons.
- To return the setting to its initial default, press the – and + buttons at the same time.
- To go back to the previous screen, press the BACK button.



4. Press **FUNCTION** to exit the setting screen.

Changing the Keyboard Tone While a Song is Playing

1. While a song is playing, press **HOME**.

The selected tone number and instrument name will appear on the display.

2. Rotate the dial to select a tone.

- For tone information, see the “Tone List” (page EN-39).
- After you rotate the dial once to select an option, you also will be able to change the selection using the – and + buttons.
- To return to the first tone in the tone list, press – and + at the same time.
- To go back to the previous screen, press the BACK button.



Assigning the Song Tone to the Keyboard (Tone Sync)

Use the procedure below to assign the song tone to the keyboard so you can play along.

1. While a song is playing or stopped, long-press **FUNCTION**.

This momentarily displays “RECOMMENDED” and assigns the song tone to the keyboard.



2. Play along with the song.

NOTE

- Tone sync also applies the song’s reverb setting to keyboard play.
- Changing the tone setting or to another song will automatically disable tone sync.

Practicing a Song Part

You can turn off the right-hand part or the left-hand part of a song you are playing and practice along with the remaining part. Use this when you feel that a song is initially too difficult for you to play with both hands at the same time.

1. While a song is playing or stopped, press the **PART** button.

Each press of the PART button cycles through the settings shown below.

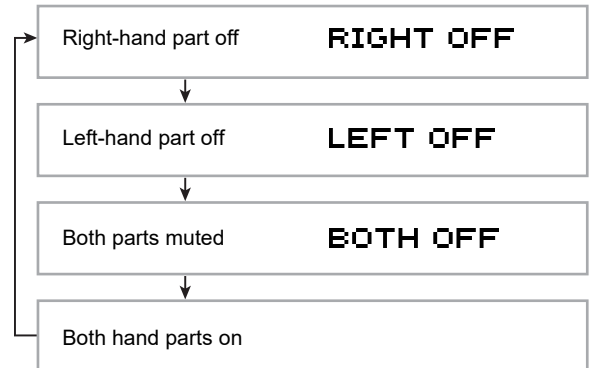

Sounding a Count in Time with a Song

You can configure count settings to sound a count in time with a song and to sound a pre-count before a song starts.

Sounding a Count

1. While the song stopped, press the COUNT button.

Press the button a number of times until "CNT" appears on the display.

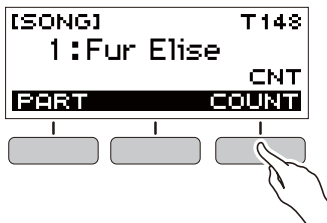

2. Press ►/■ to start the song.

A count sounds as the song is played back.

- To turn off the count, stop the song and then press the COUNT button a number of times until "CNT" disappears from the display.

NOTE

- While a count is sounding, the beat is not displayed while a song is playing.

Sounding a Pre-count

1. While the song stopped, press the COUNT button.

Press the button a number of times until "PRE" appears on the display.

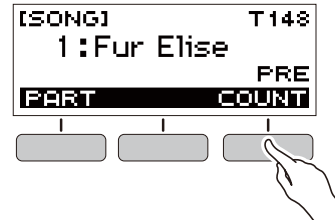

2. Press ►/■ to start the song.

This sounds a pre-count that helps you determine when to start playing along.

- To turn off the pre-count, stop the song and then press the COUNT button a number of times until "PRE" disappears from the display.

NOTE

- While the pre-count is enabled, the beat is not displayed while a song is playing.

Playing in the Dance Music Mode

Dance Music Mode

In the Dance Music Mode, you can create dance music by combining and playing multiple types of pattern phrases, and by applying effects. Pattern phrases of each part can be combined, making it possible to enjoy dance music like a DJ.

Entering the Dance Music Mode (page EN-20) changes the functions of the keyboard keys as shown below.

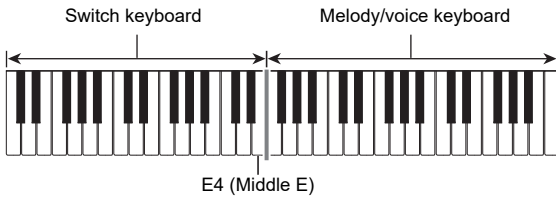

Switch Keyboard Functions

The keys of the left-half switch keyboard have the functions below.

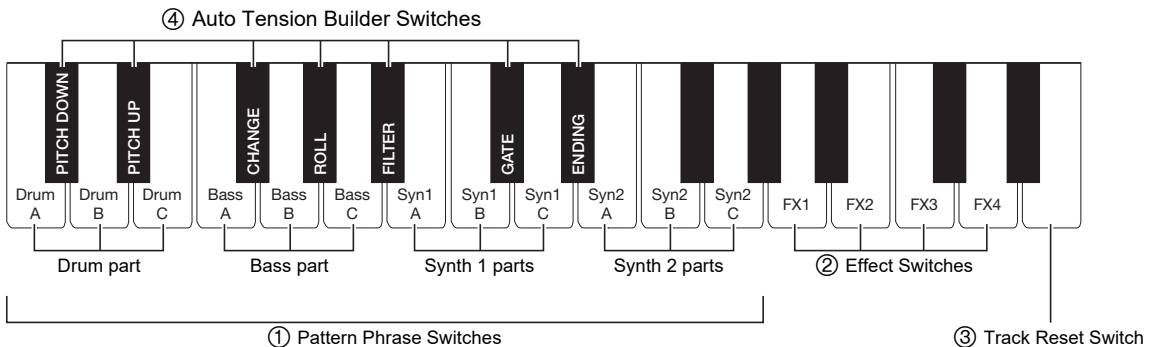

① Pattern Phrase Switches

These keys switch the pattern phrase and turn pattern phrases on or off. There are four parts: Drum, Bass, Synth 1 and Synth 2, and three different pattern phrases can be assigned to each.

② Effect Switches

While an Effect Switch key is depressed, the corresponding effect is applied to the entire song. (Using Effects, page EN-22)

③ Track Reset Switch

Pressing this key while a song is playing returns to the beginning of the current phrase.

④ Auto Tension Builder Switches

These keyboard keys can be used to apply build-up effects that are characteristic of dance music. (Building Performance Tension, page EN-23)

Melody/Voice Keyboard Functions

The right-side melody/voice keyboard can be used to play a melody along with pattern play, and, with the Voice Function, to sound voices. (Using a Dance Music Voice, page EN-22)

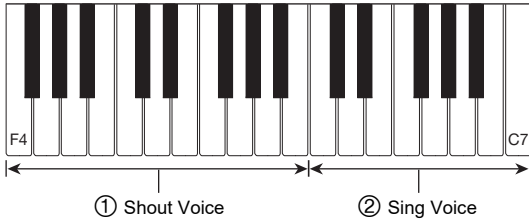

① Shout Voice

Pressing a keyboard key while the Dance Music Voice setting is enabled sounds a voice that is characteristic of dance music.

② Sing Voice

Pressing a keyboard key while the Dance Music Voice setting is enabled sounds a voice that resembles singing.

NOTE

- Sing Voice continues to sound the voice until the keyboard key is released.

Playing Dance Music

1. Press HOME.

This displays the home screen.

2. Press the DANCE button.

This displays the currently selected Dance Music number and pattern name.



NOTE

- Entering the Dance Music Mode while the metronome is sounding or while a rhythm is playing will cause the ongoing operation to stop.

3. Rotate the dial to select a song.

- After you rotate the dial once to select an option, you also will be able to change the selection using the – and + buttons.
- To return to the first Dance Music number, press the – and + buttons at the same time.
- To go back to the previous screen, press the BACK button.



NOTE

- For a list of patterns, see the “Dance Music Mode List” (page EN-43).
- Changing the pattern normally changes the tempo to the setting assigned to each pattern.

4. Press a pattern phrase bass part key to start bass part play. Next, layer phrases in the following sequence: Drum Part, Synth 1 Part, Synth 2 Part.

This starts the Bass Part pattern followed by the other parts being sequentially added to create an exciting build-up.



NOTE

- You can also start or stop pattern play by pressing ►/■.

5. Play while trying out different combinations by changing phrases of parts, and by adding or removing parts.

- Use the Effect Switches and Auto Tension Builder Switches to change patterns.
- Pressing a keyboard key that corresponds to a pattern phrase that is currently sounding stops the phrase.

Changing the Dance Music Tempo

You can use the tempo setting operation to change the tempo of pattern play.

1. In the Dance Music Mode, select the pattern whose tempo you want to change and then press **TEMPO**.

This displays the [TEMPO] screen.

2. Rotate the dial to change the tempo setting.

- You can specify a tempo value in the range of 20 to 255.
- You can also use the – and + buttons to change the setting. Press the – button to make the tempo slower or the + button to make it faster. Holding down either button scrolls the setting value.
- To return to the recommended setting, press – and + at the same time.
- Changing the Dance Music number will also return the pattern to its recommended tempo.
- To go back to the previous screen, press the EXIT button.



Changing the Dance Music Volume Level

1. Press **FUNCTION**.

This displays the [FUNCTION] screen.

2. Use the < and > buttons to select “Dance Volume”.

- To go back to the previous screen, press the EXIT button.



3. Rotate the dial to adjust the Dance Music volume level.

- You can specify a volume value from 0 to 127.
- After you rotate the dial once to select an option, you also will be able to change the selection using the – and + buttons.
- To return the setting to its initial default, press the – and + buttons at the same time.
- To go back to the previous screen, press the BACK button.



4. Press **FUNCTION** to exit the setting screen.

Changing the Keyboard Tone While Dance Music is Playing

1. While Dance Music is playing, press **HOME**.

The selected tone number and instrument name will appear on the display.

2. Rotate the dial to select a tone.

- For tone information, see the “Tone List” (page EN-39).
- After you rotate the dial once to select an option, you also will be able to change the selection using the – and + buttons.
- To return to the first tone in the tone list, press – and + at the same time.
- To go back to the previous screen, press the BACK button.



NOTE

- If you change the tone setting while the Dance Music Voice setting (page EN-22) is enabled, the tone will not change until you disable the Dance Music Voice setting.

Using the Recommended Tone

- In the Dance Music Mode, long-press FUNCTION.**

This momentarily displays "RECOMMENDED" and assigns the tone recommended for the currently selected pattern.



NOTE

- If you change the tone setting while the Dance Music Voice setting is enabled, the tone will not change until you disable the Dance Music Voice setting.

Using a Dance Music Voice

- In the Dance Music Mode, press the VOICE button.**

This causes "VOICE" to appear, which indicates that the Melody/Voice Keyboard has been changed from Melody Tone to Voice Tone.

- To return to the Melody Tone, press the VOICE button again.

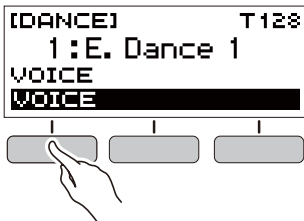

NOTE

- Dance Music voices are not affected by Transpose and Sustain settings.

Using Effects

Pressing an Effect Switch key during pattern play applies one of the effects described below to the entire song.

Keyboard Key	Function	Effect, Description
FX1	MOD LPF*1	Cuts the high-range frequencies of the sound.
FX2	MOD HPF*2	Cuts the low-range frequencies of the sound.
FX3	FLANGER	Applies an undulating surge effect to the sound.
FX4	LO-FI	Reduces the resolution of the sound.

*1 Modulation Low Pass Filter

*2 Modulation High Pass Filter

NOTE

- The display shows the applicable function name while an effect is being applied.
- An effect is applied as long as its keyboard key is depressed, and stops being applied when the key is released.
- The application manner of MOD LPF and MOD HPF changes with the tempo.
- Effects are applied to overall pattern play, and cannot be applied to individual parts.

Building Performance Tension

While pattern play is in progress, you can use the build-up function to apply dance music effects and build up tension.

Function Name	Description	Remarks
PITCH	Each press of a keyboard key changes the overall pitch of the song. Pressing the PITCH DOWN key lowers the pitch in semitone units, while PITCH UP raises the pitch in semitone units.	*1
CHANGE	Instantly changes the pattern phrase of the current song.	*1
ROLL	Cuts out part of a song, repeats it, and applies fine performance effects.	*2 *3
FILTER	Applies effects that make notes darker (by cutting high-range frequencies) or brighter (by cutting low-range frequencies).	*2 *3
GATE	Applies an effect that finely chops a song.	*2 *3
ENDING	Ends the current song while applying various effects.	*2 *3

- *1 Depending on the part, some pattern phrases are not changed.
- *2 How an effect is applied changes randomly with each keyboard key press. Effects are applied for a fixed amount of time.
- *3 While Dance Music Voice is enabled, automatically plays back the effect along with the Voice Tone.

NOTE

- Build-up execution timing is the beat immediately after a keyboard key is pressed.
- Though effects and build-up functions can be used at the same time, the effect currently being executed may stop.
- The display shows the applicable function name while a build-up function is being used.
- If the ENDING effect is used, Dance Music play stops after the effect is complete.
- If the pattern phrase is changed while the ENDING effect is being applied, play of only the newly selected part continues without stopping after the effect is complete.

Playing with a Rhythm Backing

You can use the procedures in this section to select the rhythm you want, and then automatically play accompaniments to suit it simply by playing chords with your left hand. It's like having a personal backup group along with you wherever you go.

NOTE

- Auto Accompaniments are made up of the parts (instruments) below.
 - Rhythm (percussion)
 - Bass (bass instruments)
 - Harmony (other instruments)
 You can have only the rhythm part play, or you can have all three parts play at the same time.

Rhythm

The rhythm part is the foundation of each Auto Accompaniment. Your Digital Keyboard comes with a variety of built-in rhythms, including 8-beat and waltz. Use the procedure below to play the basic rhythm part.

Playing a Rhythm

1. **Press HOME.**
This displays the home screen.
2. **Press the RHYTHM button.**
This displays the [RHYTHM] screen, which shows the currently selected rhythm number and name.

```
[RHYTHM]          T120
  1 : Straight 8Bt
VAR1
PTRN FILL-IN ACPM
```

NOTE

- Changing the rhythm while the metronome is sounding, or while song or Dance Music Mode play is in progress will cause the ongoing operation to stop.

3. **Rotate the dial to select a rhythm.**

This causes the category name to appear on the display.

- For information about rhythm types, see the “[Rhythm List](#)” (page EN-44).
- After you rotate the dial once to select an option, you also will be able to change the selection using the – and + buttons.
- To go back to the previous screen, press the BACK button.

```
[RHYTHM]          T120
  1 : Straight 8Bt
  8 BEAT
  BACK  -    +
```

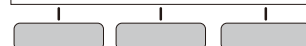

4. Press ►/■.

This starts the rhythm and displays the beat.



5. To stop the rhythm, press ►/■ again.

Changing the Tempo of a Rhythm

Use the procedure below to change tempo to a speed that suits you.

1. On the [RHYTHM] screen, select the name of the rhythm whose tempo you want to change and then press TEMPO.

This displays the [TEMPO] screen.

2. Rotate the dial to change the tempo setting.

- You can specify a tempo value in the range of 20 to 255.
- You can also use the – and + buttons to change the setting. Press the – button to make the tempo slower or the + button to make it faster. Holding down either button scrolls the setting value.
- To return to the recommended setting, press – and + at the same time.
- To go back to the previous screen, press the EXIT button.



Changing the Volume Level of a Rhythm

Use the procedure below to adjust the balance between the volume levels of keyboard play and the rhythm.

1. Press FUNCTION.

This displays the [FUNCTION] screen.

2. Use the < and > buttons to select “Rhythm Volume”.

- To go back to the previous screen, press the EXIT button.

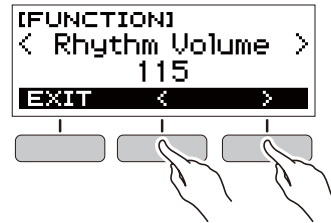

3. Rotate the dial to adjust the rhythm volume level.

- You can specify a volume value from 0 to 127.
- After you rotate the dial once to select an option, you also will be able to change the selection using the – and + buttons.
- To return the setting to its initial default, press the – and + buttons at the same time.
- To go back to the previous screen, press the BACK button.



4. Press FUNCTION to exit the setting screen.

Changing the Keyboard Tone While a Rhythm is Playing

1. **While a rhythm is playing, press HOME.**
The selected tone number and instrument name will appear on the display.
2. **Rotate the dial to select a tone.**
 - For tone information, see the “Tone List” (page EN-39).
 - After you rotate the dial once to select an option, you also will be able to change the selection using the – and + buttons.
 - To return to the first tone in the tone list, press – and + at the same time.
 - To go back to the previous screen, press the BACK button.



Using Recommended Rhythm Settings

You can use the procedure below to use tone, and tempo settings that are most suitable for a particular rhythm pattern.

1. **On the [RHYTHM] screen, select a rhythm name and then long-press FUNCTION.**
This momentarily displays “RECOMMENDED” and configures the recommended rhythm settings.



Changing the Rhythm Pattern

You can use the procedure below to add liveliness to your rhythm pattern by playing intro and ending patterns, fill-in patterns, and variations of basic rhythm patterns. Each Auto Accompaniment pattern has a basic “normal pattern” as well as a “variation pattern”. This lets you play a pattern that is different from the Normal Pattern.

1. **In the Rhythm Mode, press the PTRN button.**
This causes “VAR2” to appear on the display.
 - Press the PTRN button again to return to the “VAR1” screen.

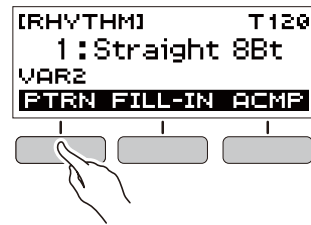

2. **Press ▶/■.**
This starts the rhythm for the pattern you selected.
 - If you press the PTRN button while a rhythm is playing, the pattern will change from the beginning of the following measure.



Inserting a Fill-in Phrase

A “fill-in” is a short phrase played where you want to change the mood of a piece. A fill-in pattern can be used to create a link between two melodies or as an accent.

1. While a rhythm is playing, press the PTRN button and then select a pattern.
2. Press the FILL-IN button.

With some patterns, the fill-in continues until the end of the measure where it is inserted. FILL is displayed while a fill-in is playing.

- To continue the fill-in into the next measure, keep the FILL-IN button depressed.
- Pressing the FILL-IN button while a rhythm is stopped will insert the fill-in and cause it to be played as soon as rhythm play is started. In this case, pressing the FILL-IN button again before starting rhythm play will remove the fill-in.

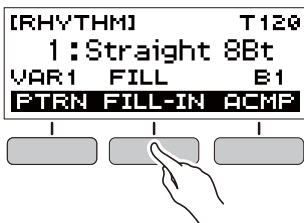

Fingering a Chord to Play a Rhythm Accompaniment

Playing a chord with your left hand automatically adds bass and harmony accompaniment parts to the currently selected rhythm. It is just like having your own personal back up group on call.

1. In the Rhythm Mode, press the ACMP button. This causes “AC” to appear on the display and enables chord fingering with the accompaniment (left-side) keyboard.

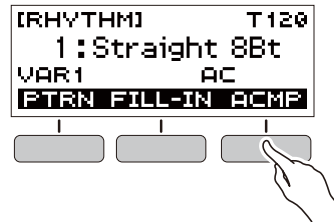

2. Press ►/■ to start the rhythm.
3. Play something on the accompaniment keyboard.

This will sound the bass, harmony, and other non-rhythm part instruments.

Accompaniment keyboard

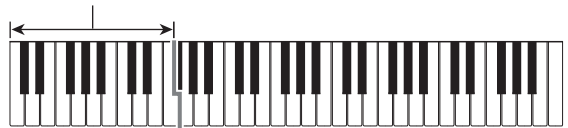

NOTE

- Playing a chord while rhythm play is stopped will cause rhythm and accompaniment to start at the same time.

4. Play other chords with your left hand as you play the melody with your right hand.
5. Press the ACMP button again to stop the accompaniment.

Selecting a Chord Fingering Mode

You can select from among the six chord fingering modes below.

- CASIO CHORD
- FINGERED 1
- FINGERED 2
- FINGERED ON BASS
- FINGERED ASSIST
- FULL RANGE CHORD

1. Press **FUNCTION**.

This displays the [FUNCTION] screen.

2. Use the **<** and **>** buttons to select “Chord Mode”.

- To go back to the previous screen, press the EXIT button.

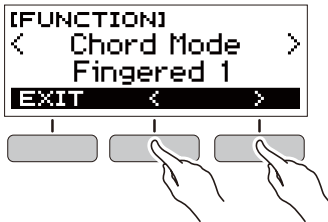

3. Rotate the dial to select a chord fingering mode.

- After you rotate the dial once to select an option, you also will be able to change the selection using the – and + buttons.
- To go back to the previous screen, press the BACK button.



■ CASIO CHORD

With CASIO CHORD, you can use simplified fingerings to play the four types of chords described below.

Accompaniment keyboard

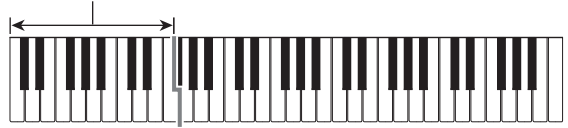

Chord Type	Example
Major Chords Letters above the accompaniment keyboard indicate the name of the chord assigned to each key. Accompaniment keyboard keys marked with the same chord name play exactly the same chord.	C (C Major)
Minor Chords Press the key that corresponds to the major chord, while also pressing one other accompaniment area key to the right.	Cm (C Minor)
Seventh Chords Press the key that corresponds to the major chord, while also pressing two other accompaniment area keys to the right.	C7 (C Seventh)
Minor Seventh Chords Press the key that corresponds to the major chord, while also pressing three other accompaniment area keys to the right.	Cm7 (C Minor Seventh)

NOTE

- When playing a minor, seventh, or minor seventh chord on the accompaniment keyboard, it makes no difference whether the additional keys you press are black or white.

■ FINGERED

With this chord fingering mode, you play chords on the accompaniment keyboard using their normal chord fingerings. Note that some chords can also be formed using abbreviated fingerings of one or two keys. For information about the types of chords you can finger and their fingerings, see the “Fingering Guide” (page EN-45).

Accompaniment keyboard

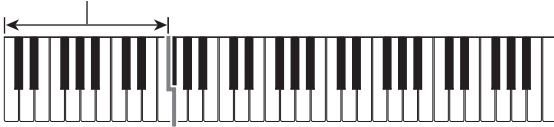

● FINGERED 1

Play the component notes of the chord on the keyboard.

● FINGERED 2

Unlike FINGERED 1, 6th input is not possible with this mode.

● FINGERED ON BASS

Play the component notes of the chord on the keyboard. This mode allows input of fraction chords with the lowest keyboard note as the base note.

● FINGERED ASSIST

In addition to FINGERED 1 input, you can also use the fingerings below to play the three chord types.

Minor Chords (Cm)	One keyboard key for the base note and the nearest black key to the left.
Seventh Chords (C7)	One keyboard key for the base note and the nearest white key to the left.
Minor Seventh Chords (Cm7)	One keyboard key for the base note and the nearest black key and white key to the left.

■ FULL RANGE CHORD

With this chord fingering mode, you can use the full range of the keyboard to play chords and the melody.

Accompaniment Keyboard/Melody Keyboard

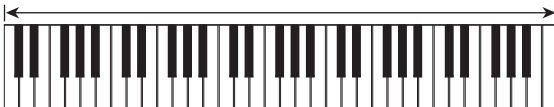

Inserting an Intro or an Ending

Use the procedure below to insert an intro or ending pattern of a few measures.

1. In the Rhythm Mode, long-press the ACMP button.

This momentarily displays “INTRO/ENDING ON” and then “INTRO>V1” as the current pattern.

- To disable INTRO/ENDING and display “INTRO/ENDING OFF”, long-press the ACMP button again.

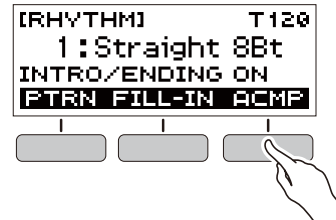

2. To change the pattern, press the PTRN button.

Each press of the PTRN button cycles the setting in the following sequence: “INTRO>V1”, “INTRO>V2”, “V1”, “V2”.

- “INTRO>V1” and “INTRO>V2” are patterns with intros.
- “V1” and “V2” are short for “VAR1” and “VAR2”.

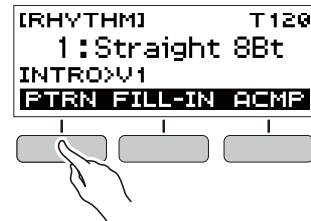

3. Press ►/■ to start rhythm play.

If you selected a pattern with an intro, play starts with the intro and then the pattern starts to sound after the intro is complete.

- Instead of pressing ►/■ to start rhythm play, you can also press the ACMP button to display the “AC” indicator. In this case, playing a chord will start the intro with the accompaniment.
- To stop an intro and switch to pattern play, press the PTRN button.
- Note that you cannot select “INTRO>V1” or “INTRO>V2” while rhythm play is in progress.

4. At the point where you want to sound the ending, press ►/■.

This will cause “ENDING” to appear on the display. The ending will play and then the rhythm will stop.

■ Configuring [FUNCTION] Screen Settings

1. Press **FUNCTION**.

This displays the [FUNCTION] screen.

2. Use the **<** and **>** buttons to select “Intro/Ending”.

- To go back to the previous screen, press the EXIT button.

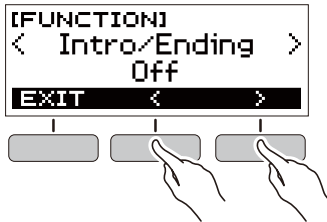

3. Rotate the dial to select “On”.

- You can also use the – and + buttons to change the setting. Pressing the – button selects “Off”, while the + button selects “On”.
- To go back to the previous screen, press the BACK button.



4. Press **FUNCTION** to exit the setting screen.

Connecting with External Devices



Linking with a Smart Device (APP Function)

You can use the APP function to connect the Digital Keyboard with a phone, tablet or other smart device and perform the operations described below.

- Use the Digital Keyboard sound source to sound music data played using an app on the smart device.
- Use the lesson functions of an app on the smart device, playing notes on the Digital Keyboard keyboard.

! IMPORTANT!

- **Configure the settings on your smart device (Airplane Mode, etc.) to disable data communication.**
- **When connecting a smart device to the Digital Keyboard, do not connect both a USB cable and an audio cable at the same time.**

■ Downloading the Smart Device App

Download the Chordana Play from the CASIO website and install it on the smart device.

<https://support.casio.com/global/en/emi/manual/CT-S200/>



■ Linking the Digital Keyboard with a Smart Device

1. Referring to “[Downloading the Smart Device App](#)” (page [EN-29](#)), install the app on the smart device.
2. Use a commercially available USB cable to connect the smart device USB port to the Digital Keyboard USB port.
 - After connecting the smart device to the Digital Keyboard, use the smart device app to perform operations. For details about operations, refer to the user documentation of the app.

Digital Keyboard **USB** port (Micro-B)

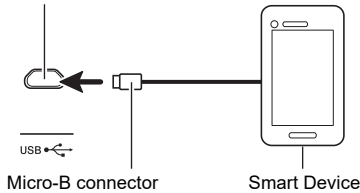

Connecting to a computer and Using MIDI

You can connect the Digital Keyboard to a computer and exchange MIDI data between them. You can record Digital Keyboard play using computer music software, and use the Digital Keyboard to play data sent to it from the computer.

■ Minimum Computer System Requirements

The following shows the minimum computer system requirements for sending and receiving MIDI data. Be sure to check your computer system setup before trying to install the driver.

● Supported Operating Systems

Windows 7*1

Windows 8.1*2

Windows 10*3

macOS (OS X/Mac OS X) 10.7, 10.8, 10.9, 10.10, 10.11, 10.12, 10.13, 10.14

*1 Windows 7 (32-bit, 64-bit)

*2 Windows 8.1 (32-bit, 64-bit)

*3 Windows 10 (32-bit, 64-bit)

● USB Port

! IMPORTANT!

- Never connect the Digital Keyboard to a computer running an operating system that is not one of those above. Doing so can cause malfunction of the computer.

! NOTE

- For the latest news about supported operating systems, visit the website at the URL or QR code below.
<https://support.casio.com/global/en/emi/manual/CT-S200/>



■ Connecting to a Computer

! IMPORTANT!

- Incorrect connections can make data exchange impossible. Be sure to follow the steps of the procedure below.

1. Turn off the Digital Keyboard and then start up your computer.
 - Do not start up the music software on your computer yet!
2. Use a commercially available USB cable to connect the Digital Keyboard to your computer.
 - Use a USB 2.0 or 1.1 A-MicroB connector type USB cable that supports data communication.
3. Turn on the Digital Keyboard.
 - If this is the first time you are connecting, the driver required to transfer data will automatically be installed on your computer.
4. Start up commercially available music software on your computer.
5. Use the settings of your computer's commercially available music software to select “CASIO USB-MIDI!” as the MIDI device.
 - For information about how to select the MIDI device, refer to the user documentation that comes with the music software you are using.

! IMPORTANT!

- Be sure to turn on the Digital Keyboard before starting up your computer's music software.
- Data send/receive cannot be performed while a song is playing (page [EN-15](#)).

NOTE

- Once you are able to connect successfully, you can leave the USB cable connected when you turn off your computer and/or Digital Keyboard.
- For detailed specifications and connections that apply to MIDI data communication by this Digital Keyboard, see the latest support information provided on the website at the URL or QR code below.
<https://support.casio.com/global/en/emi/manual/CT-S200/>

**■ Configuring MIDI Settings**

For information about the MIDI settings below, refer to the “Setting Item List” (page EN-32).

- MIDI Out Channel
- MIDI Out Octave Shift
- MIDI Out Velocity
- Local Control

Connecting with Audio Equipment

You can connect the Digital Keyboard to a commercially available stereo system or amplifier, or to a recording device. You can also use the Digital Keyboard to sound output from a portable audio player or another device, and use that as backing for your keyboard play.

■ Sounding Digital Keyboard Output on an External Device

Connection requires commercially available connecting cords, supplied by you.

- The connecting cord should have a stereo mini plug on one end and a plug that matches the configuration of the input jack of the external device on the other end.

! IMPORTANT!

- **Turn off the external device and the Digital Keyboard before connecting them. Before turning power on or off, turn down the volume level of the Digital Keyboard and external devices.**
- **After connecting, turn on the Digital Keyboard first and then the external device.**
- **If Digital Keyboard notes are distorted when they are sounded on an external audio device, lower the Digital Keyboard’s volume level.**

Digital Keyboard **PHONES/OUTPUT** jack (3.5mm stereo mini jack)

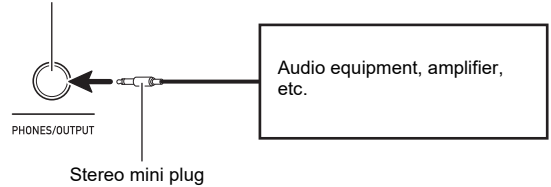
**■ Sounding Input From an External Device on the Digital Keyboard**

Connection requires commercially available connecting cords, supplied by you.

- The connecting cord should have a stereo mini plug (3-pole) on one end for connection to the Digital Keyboard and a plug that matches the configuration of the output jack of external device on the other end.
- When sounding input from an external device with the Digital Keyboard, use the external device controls to adjust the volume level. In this case, you cannot adjust the volume level on the Digital Keyboard.

! IMPORTANT!

- **Turn off the Digital Keyboard before connecting. Before turning power on or off, turn down the volume level of the Digital Keyboard and external devices.**
- **After connecting, turn on the external device and then the Digital Keyboard.**
- **If external device notes sounded by the Digital Keyboard are distorted, lower the external device’s volume level.**

Digital Keyboard **AUDIO IN** jack (3.5mm stereo mini jack)

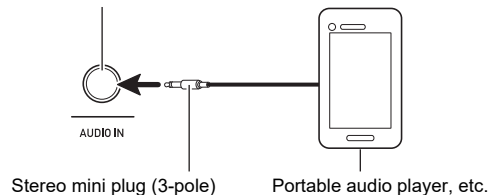

Configuring Function Settings

Configuring Settings

Use the procedure below to configure settings.

1. Press **FUNCTION**.

This displays the [FUNCTION] screen.

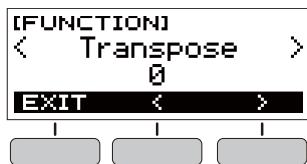

2. Use the **<** and **>** buttons to select a setting item.

- To go back to the previous screen, press the EXIT button.

3. Rotate the dial to change the setting.

- After you rotate the dial once to select an option, you also will be able to change the selection using the – and + buttons.
- To go back to the previous screen, press the BACK button.

4. Press **FUNCTION** to exit the setting screen.

Setting Item List

Function Name	Description	Display Name	Setting Options
Transpose	Raises or lowers the overall pitch in semitone steps. You can use this feature to raise or lower the key of the keyboard to make it easier to play a piece written in a difficult key, or to adjust to a key that better matches a vocalist, another musical instrument, etc.	Transpose	–12 to 0 to +12
Reverb	Specifies the type of reverb to be applied.	Reverb	Off, Room 1, Room 2, Room 3, Room 4, Hall 1, Hall 2, Hall 3, Hall 4, Stadium 1, Stadium 2
Pedal	Assigns a damper function to a pedal. The pedal can be used to sustain notes and to apply other effects during performances.	Pedal	Pedal Sustain, Sostenuto, Soft, Start/Stop
Intro/Ending	Assigns an intro that sounds when a rhythm starts or an ending when the rhythm is stopped.	Intro/Ending	Off, On
Chord Mode	Specifies the chord fingering mode.	Chord Mode	CASIO Chord, Fingered 1, Fingered 2, Fingered on Bass, Fingered Assist, Full Range Chord
Rhythm volume	Adjusts the rhythm volume level.	Rhythm Volume	0 to 127
Song volume	Adjusts the song volume level.	Song Volume	0 to 127
Dance Music volume level	Adjusts the dance music volume level.	Dance Volume	0 to 127
Tuning	Fine tunes the overall pitch of the Digital Keyboard by changing the frequency of A4 in 0.1Hz units.	Tuning	415.5 to 440.0 to 465.9
MIDI Out Channel	Specifies the channel to output MIDI messages.	MIDI Out Ch	1 to 16
MIDI Out Octave Shift	Specifies, in octave units, the note message key number for MIDI Out.	MIDIOutOctShift	–3 to 0 to +3
MIDI Out Velocity	Specifies the velocity of the note on message for MIDI Out.	MIDIOutVelocity	Off, 1 to 127

Function Name	Description	Display Name	Setting Options
Power On Volume Level	Specifies the power on volume level.	PowerOnVolume	1 to 10
MY SETUP Power On	When enabled, automatically configures MY SETUP settings when the Digital Keyboard is turned on.	PowerOnMySetup	Off, On
Local Control	When enabled, mutes notes when something is played on the Digital Keyboard.	Local Control	Off, On
Auto Power Off	Enables/disable Auto Power Off.	Auto Power Off	Off, On
Batteries	Specifies the type of batteries being used.	Battery	Alkaline, Ni-MH
LCD Contrast	Adjusts display contrast.	LCD Contrast	1 to 12
Initialize	Returns all settings to their factory defaults.	Initialize	
Version Information	Shows version information.	Version	

IMPORTANT!

- Turning power off and back on again returns tone and other settings to their initial defaults (page [EN-7](#)).
- The settings below are retained even when power is turned off.
 - MIDI Out Channel
 - MIDI Out Octave Shift
 - MIDI Out Velocity
 - Startup volume level
 - MY SETUP Startup
 - Auto Power Off
 - Battery type
 - LCD contrast

Returning Settings to Their Initial Factory Defaults

1. Press **FUNCTION**.

This displays the [FUNCTION] screen.

2. Use the **<** and **>** buttons to select "Initialize".

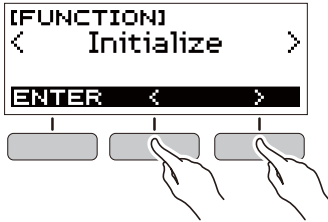

3. Press the **ENTER** button.

This causes "Sure?" to appear on the display.



4. Press the **YES** button.

After initialization is complete, the message "GOING TO RESTART" appears on the display for a few seconds, and then the Digital Keyboard restarts.



Checking Version Information

1. Press **FUNCTION**.

This displays the [FUNCTION] screen.

2. Use the **<** and **>** buttons to select "Version".

This displays version information.

- To go back to the previous screen, press the EXIT button.

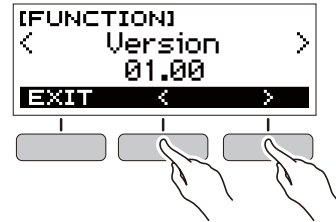

3. Press **FUNCTION** to exit.

Troubleshooting

Symptom	Required Action
Included Accessories	
I can't find included items during unpacking.	Carefully check inside all of the packing materials.
Power Requirements	
Power does not turn on.	<ul style="list-style-type: none"> Check the AC adaptor or make sure that the batteries are facing correctly (page EN-4). Replace the batteries with new ones. Or use AC adaptor power (page EN-4).
The Digital Keyboard suddenly turns off after outputting a loud sound.	Replace the batteries with new ones. Or use AC adaptor power (page EN-4).
The Digital Keyboard suddenly powers down after about 30 minutes.	Disable Auto Power Off (page EN-8).
Display	
The display keeps going dark or keeps flickering.	Replace the batteries with new ones. Or use AC adaptor power (page EN-4).
Screen contents are visible only from a fixed angle.	This is due to Digital Keyboard's production limitations. It does not indicate malfunction.
Sound	
Nothing happens when I press a keyboard key.	<ul style="list-style-type: none"> Adjust the volume level (page EN-8). Check if something is plugged into the PHONES/OUTPUT jack on the back of the Digital Keyboard. Try turning the Digital Keyboard off and then back on again (page EN-7) to initialize settings.
Nothing happens or notes do not play normally when I play on the accompaniment (left-side) keyboard.	Press the ACMP button to disable chord input with the accompaniment keyboard (page EN-26).
Nothing happens when I start an Auto Accompaniment.	<ul style="list-style-type: none"> With rhythms 76 and 77, nothing will sound if you do not play a chord on the keyboard. Try playing a chord (page EN-26). Check and adjust the rhythm volume level (page EN-24). Try turning the Digital Keyboard off and then back on again (page EN-7) to initialize settings.
Nothing happens when I start playing a song's Auto Accompaniment.	<ul style="list-style-type: none"> It takes a little time after you press the button until the song starts to play. Wait for the song to start. Check and adjust the song volume level (page EN-16). Try turning the Digital Keyboard off and then back on again (page EN-7) to initialize settings.
The metronome does not sound.	<ul style="list-style-type: none"> Check and adjust the metronome volume level (page EN-9). Try turning the Digital Keyboard off and then back on again (page EN-7) to initialize settings.
Notes keep sounding, without stopping.	<ul style="list-style-type: none"> Try turning the Digital Keyboard off and then back on again (page EN-7) to initialize settings. Replace the batteries with new ones. Or use AC adaptor power (page EN-4).
Some notes are cut off while they are playing.	Notes are cut off whenever the number of notes being sounded exceeds the maximum polyphony value of 48 (24 for some tones). This does not indicate malfunction.
The volume level or tone setting I configured has changed.	<ul style="list-style-type: none"> Adjust the volume level (page EN-8). Try turning the Digital Keyboard off and then back on again (page EN-7) to initialize settings. Replace the batteries with new ones. Or use AC adaptor power (page EN-4).

Symptom	Required Action
With certain volume levels and tones, the sound of notes played in one keyboard range will sound different from those played in another keyboard range.	This is due to system limitations and does not indicate malfunction.
With some tones, octaves do not change at the far ends of the keyboard.	This is due to system limitations and does not indicate malfunction.
The pitch of the notes does not match other accompanying instruments or notes sound strange when played along with other instruments.	<ul style="list-style-type: none"> Check and adjust the transpose setting (page EN-12) and tuning setting (page EN-12). Try turning the Digital Keyboard off and then back on again (page EN-7) to initialize settings.
The reverb of notes seems to change suddenly.	<ul style="list-style-type: none"> Check and adjust the reverb setting (page EN-11). Try turning the Digital Keyboard off and then back on again (page EN-7) to initialize settings.
Connecting to a computer	
I can't perform MIDI data transfers.	<ul style="list-style-type: none"> Check to make sure that the USB cable is connected to the Digital Keyboard and computer, and that the correct device is selected with your computer's music software (page EN-30). Turn off the Digital Keyboard and then exit the music software on your computer. Next, turn the Digital Keyboard back on and then restart the music software on your computer.

Product Specifications

Model	CT-S200BK, CT-S200WE, CT-S200RD
Keyboard	61 keys
Maximum Polyphony	48 notes
Tones	
Preset Tones	400 preset tones (1 stereo piano tone)
Effects	Reverb (10 types, Off)
Metronome	
Beat	Off, 1 to 16 beats
Tempo	20 to 255
Song Bank	
Preset Songs	60 songs
Part Off	Left hand, right hand, both hands
Auto Accompaniment	
Preset Rhythms	77 types
One Touch Presets	77 types
Other	INTRO, ENDING; chord input mode switching
Dance Music Mode	
Preset Patterns	50 types; Dance Music effects
Demo Play	Looped play of all built-in Song Bank songs (60 songs)
Function Volume Adjustment	Metronome, Rhythm, Song, Dance Music
Other Functions	
Transpose	±1 octave (-12 to 0 to +12 semitones)
Tuning	A4 = 415.5 to 465.9 Hz (Initial Default: 440.0 Hz)
MIDI	16 multi-timbre received, GM Level 1 standard
APP function	
Supported Devices	iOS, Android (USB terminal connection)

Jacks	
USB Port	Micro-B
PEDAL jack	Standard jack (6.3mm) (Pedal sustain, sostenuto, soft, start/stop)
PHONES/OUTPUT jack	Stereo mini jack (3.5mm)
AUDIO IN jack	Stereo mini jack (3.5mm) Input impedance: 10 k Ω , Input sensitivity: 200 mV
AC adaptor terminal	9.5V DC
Power Requirements	2-Way Power
Batteries	6 AA-size alkaline batteries or AA-size rechargeable nickel metal hydride batteries
Continuous operation	Approximately 16 hours (alkaline batteries), approximately 13 hours (rechargeable nickel metal hydride batteries)* Actual battery life may be shorter depending on battery type, performance style, or operation environment.
AC Adaptor	AD-E95100L (JEITA Standard, with unified polarity plug)
Auto Power Off	After approximately 30 minutes of non-operation, Can be disabled.
Speakers	13cm \times 6cm (oval) \times 2 (Output: 2.0W + 2.0W)
Power Consumption	9.5V --- 5.5W
Dimensions	93.0 (W) \times 25.6 (D) \times 7.3 (H) cm (36 5/8 \times 10 1/16 \times 2 7/8 inch)
Weight	Approximately 3.3kg (7.3 lbs) (Excluding batteries)

* Measured values while using eneloop batteries.
eneloop is a trademark of Panasonic Corporation.

- Specifications and designs are subject to change without notice.

AC Adaptor Handling Precautions

Model: AD-E95100L

1. Read these instructions.
2. Keep these instructions on hand.
3. Heed all warnings.
4. Follow all instructions.
5. Do not use this product near water.
6. Clean only with a dry cloth.
7. Do not install near radiators, heat registers, stoves, or any other source of heat (including amplifiers).
8. Use only attachments and accessories specified by the manufacturer.
9. Refer all servicing to qualified service personnel. Servicing is required after any of the following occurs: when the product is damaged, when the power supply cord or plug is damaged, when liquid is spilled into the product, when a foreign object falls into the product, when the product is exposed to rain or moisture, when the product does not operate normally, when the product is dropped.
10. Do not allow the product to be exposed to dripping or splashing liquid. Do not place any object containing liquid on the product.
11. Do not allow the electrical load output to exceed the label rating.
12. Make sure the surrounding area is dry before plugging into a power source.
13. Make sure the product is oriented correctly.
14. Unplug the product during lightning storms or when you do not plan to use it for a long time.
15. Do not allow product ventilation openings to become blocked. Install the product in accordance with the manufacturer's instructions.
16. Take care the power cord is located where it will not be stepped upon or bent severely, particularly in locations close to plugs and convenience receptacles, and in locations where it exits from the product.
17. The AC adaptor should be plugged into a power outlet as close to the product as possible to allow immediate disconnection of the plug in case of emergency.

The symbol below is an alert indicating un-insulated hazardous voltage inside the product's enclosure, which may be sufficient to constitute the risk of electric shock to users.



The symbol below is an alert indicating the presence of important operating and maintenance (servicing) instructions in the documentation that accompanies the product.



Tone List

No.	Tone Name	Program Change	Bank Select MSB
PIANO			
1	STEREO GRAND PIANO	0	2
2	GRAND PIANO	0	1
3	BRIGHT PIANO	1	2
4	MODERN PIANO	1	3
5	DANCE PIANO	1	1
6	MELLOW PIANO	0	3
7	STRINGS PIANO	0	8
8	HONKY-TONK	3	2
9	OCTAVE PIANO	3	9
10	BASS/PIANO	0	9
11	ELEC.GRAND PIANO	2	2
12	MODERN E.G.PIANO	2	3
13	HARPSICHORD	6	2
14	HARPSICHORD & STRINGS	6	1
ELECTRIC PIANO			
15	ELEC.PIANO	4	2
16	FM E.PIANO	5	5
17	60'S E.PIANO	4	5
18	CHORUS E.PIANO 1	4	9
19	CHORUS E.PIANO 2	4	6
20	MODERN E.PIANO	5	2
21	SOFT E.PIANO	4	8
22	SYNTH-STR.E.PIANO	4	3
23	CLEAN E.PIANO	4	4
24	CLAVI 1	7	2
25	CLAVI 2	7	3
26	SOFT CLAVI	7	1
27	DETUNE CLAVI	7	8
28	SEQUENCE CLAVI	7	9
CHROMATIC PERC.			
29	VIBRAPHONE 1	11	2
30	VIBRAPHONE 2	11	1
31	SOFT VIBRAPHONE 1	11	3
32	SOFT VIBRAPHONE 2	11	4
33	MARIMBA	12	2
34	SOFT MARIMBA	12	1
35	CELESTA 1	8	2
36	CELESTA 2	8	1
37	GLOCKENSPIEL	9	2
38	MUSIC BOX 1	10	2
39	MUSIC BOX 2	10	1
40	XYLOPHONE	13	2
41	TUBULAR BELL	14	2
42	DULCIMER	15	2
ORGAN			
43	DRAWBAR ORGAN 1	16	2
44	DRAWBAR ORGAN 2	16	1
45	PERC.ORGAN 1	17	2
46	PERC.ORGAN 2	17	3
47	ELEC.ORGAN 1	16	8
48	ELEC.ORGAN 2	16	4
49	JAZZ ORGAN 1	17	4
50	JAZZ ORGAN 2	17	6
51	ROCK ORGAN 1	18	2
52	ROCK ORGAN 2	18	1
53	FULL DRAWBAR	16	9
54	CLICK ORGAN	18	7
55	8'ORGAN	17	5
56	CHURCH ORGAN 1	19	2
57	CHURCH ORGAN 2	19	3
58	CHAPEL ORGAN	19	8
59	THEATER ORGAN	19	6
60	REED ORGAN	20	2
61	ACCORDION	21	2
62	BANDONEON	23	2
63	HARMONICA 1	22	2
64	HARMONICA 2	22	8
GUITAR			
65	NYLON STR.GUITAR	24	2

No.	Tone Name	Program Change	Bank Select MSB
66	STEEL STR.GUITAR	25	2
67	12 STR.GUITAR	25	8
68	CHORUS STEEL GT	25	9
69	JAZZ GUITAR	26	2
70	OCT.JAZZ GUITAR	26	8
71	CLEAN GUITAR 1	27	2
72	CLEAN GUITAR 2	27	1
73	MUTE GUITAR	28	2
74	OVERDRIVE GUITAR	29	2
75	DISTORTION GUITAR	30	2
76	POWER DIST.GUITAR	30	5
77	FEEDBACK GUITAR	31	8
78	DIST.GUITAR & BASS	30	6
BASS			
79	ACOUSTIC BASS	32	2
80	FINGERED BASS	33	2
81	PICKED BASS	34	2
82	FRETLESS BASS	35	2
83	SLAP BASS	37	2
84	SAW SYNTH-BASS	38	2
85	SQUARE SYNTH-BASS	39	2
86	DIGI ROCK BASS	39	1
87	TRANCE BASS	38	4
88	SINE BASS	39	6
STR/ORCHESTRA			
89	VIOLIN	40	2
90	SLOW VIOLIN	40	8
91	VIOLA	41	2
92	CELLO	42	2
93	SLOW CELLO	42	1
94	CONTRABASS	43	2
95	VIOLIN & CELLO	40	3
96	CELLO SECTION	42	4
97	PIZZICATO STRINGS	45	2
98	HARP 1	46	2
99	HARP 2	46	1
100	CHORUS HARP	46	8
ENSEMBLE			
101	STRINGS	48	2
102	SLOW STRINGS	49	2
103	WIDE STRINGS	48	16
104	CHAMBER	48	3
105	OCTAVE STRINGS	48	32
106	STRINGS SFZ	48	8
107	TREMOLO STRINGS	49	1
108	FLUTE & STRINGS	49	3
109	CHOIR STRINGS	52	3
110	SYNTH-STRINGS 1	50	2
111	SYNTH-STRINGS 2	51	2
112	SYNTH-STRINGS 3	51	3
113	FAST SYNTH-STRINGS	50	3
114	CHOIR AAHS	52	2
115	VOICE DOO	53	2
116	SYNTH-VOICE	54	2
117	SYNTH-VOICE PAD	54	8
118	CHORUS SYNTH-VOICE	54	9
119	ORCHESTRA HIT 1	55	2
120	ORCHESTRA HIT 2	55	1
BRASS			
121	TRUMPET	56	2
122	MELLOW TRUMPET	56	8
123	TRUMPET SFZ	56	1
124	TROMBONE	57	2
125	TUBA	58	2
126	MUTE TRUMPET	59	2
127	FRENCH HORN	60	2
128	FRENCH HORN SECTION	60	1
129	BRASS	61	2
130	BRASS SECTION 1	61	3
131	BRASS SECTION 2	61	6

No.	Tone Name	Program Change	Bank Select MSB
132	BRASS SECTION 3	61	7
133	MELLOW BRASS	61	1
134	HARD BRASS	61	5
135	BRASS SFZ	61	8
136	BRASS & STRINGS	61	4
137	SYNTH-BRASS 1	62	2
138	SYNTH-BRASS 2	63	2
139	ANALOG SYNTH-BRASS 1	62	8
140	ANALOG SYNTH-BRASS 2	62	9
REED/PIPE			
141	ALTO SAX 1	65	1
142	ALTO SAX 2	65	2
143	HARD A.SAX	65	3
144	BREATHY A.SAX	65	8
145	TENOR SAX	66	1
146	SOPRANO SAX 1	64	2
147	SOPRANO SAX 2	64	1
148	BARITONE SAX 1	67	2
149	BARITONE SAX 2	67	1
150	SAX SECTION	65	9
151	CLARINET	71	2
152	OBOE	68	2
153	SOLO OBOE	68	4
154	BASSOON	70	5
155	FLUTE 1	73	2
156	FLUTE 2	73	1
157	PURE FLUTE	73	8
158	PICCOLO	72	2
159	RECORDER	74	2
160	PAN FLUTE	75	2
161	BOTTLE BLOW 1	76	2
162	BOTTLE BLOW 2	76	1
163	WHISTLE	78	2
164	OCARINA	79	2
165	FLUTE & OBOE	73	3
SYNTH-LEAD			
166	SQUARE LEAD 1	80	2
167	SQUARE LEAD 2	80	3
168	SQUARE LEAD 3	80	1
169	SAW LEAD 1	81	2
170	SAW LEAD 2	81	1
171	SAW LEAD 3	81	5
172	MELLOW SAW LEAD	81	8
173	SQUARE PULSE LEAD	80	5
174	SEQUENCE SAW	81	9
175	SEQUENCE SINE	80	9
176	SINE LEAD	80	8
177	SS LEAD	81	3
178	SEQUENCE SQUARE	80	7
179	SEQUENCE PULSE	80	16
180	SLOW SAW LEAD	81	4
181	CALLIOPE	82	2
182	VENT LEAD	82	5
183	VENT SYNTH	82	1
184	CHIFF LEAD	83	2
185	SEQUENCE LEAD 1	83	5
186	SEQUENCE LEAD 2	83	3
187	VOICE LEAD	85	2
188	DISTORTION LEAD	84	8
189	CHARANG	84	2
190	CHURCH LEAD	85	4
191	SYNTH-VOICE LEAD	85	7
192	FIFTH LEAD	86	4
193	FIFTH SAW LEAD	86	2
194	FIFTH SQUARE LEAD	86	3
195	FIFTH SEQUENCE	86	1
196	BASS+LEAD	87	2
197	DANCE SQUARE LEAD	80	48
198	DANCE SYNC SQUARE LEAD	80	49
199	DANCE SAW LEAD	81	48
200	DANCE SYNC SAW LEAD	81	49
201	DANCE POLY SAW LEAD	81	50
202	DANCE SAW BASS	87	48

No.	Tone Name	Program Change	Bank Select MSB
SYNTH-PAD			
203	FANTASY 1	88	2
204	FANTASY 2	88	3
205	WARM VOX	89	8
206	WARM PAD	89	2
207	SINE PAD	89	3
208	SOFT PAD	89	4
209	OLD TAPE PAD	89	6
210	POLYSYNTH 1	90	2
211	POLYSYNTH 2	90	1
212	POLY SAW	90	8
213	SPACE CHOIR	91	1
214	HEAVEN	91	2
215	SQUARE PAD	92	1
216	BOWED PAD	92	2
217	GLASS PAD	92	3
218	ETHNIC PAD	93	2
219	HARD METAL PAD	93	4
220	CHORUS PAD	94	1
221	HALO PAD	94	2
222	SWEEP PAD	95	2
223	RAIN DROP	96	2
224	SPACE VOICE	97	1
225	SOUND TRACK 1	97	2
226	SOUND TRACK 2	97	3
227	RAVE	97	8
228	CRYSTAL	98	2
229	CHORAL BELL	98	16
230	CELESTA PAD	99	1
231	ATMOSPHERE	99	2
232	BRIGHT BELL PAD	100	1
233	BRIGHTNESS	100	2
234	GOBLIN	101	2
235	ECHO PAD	102	2
236	ECHO DROP	102	3
237	POLY DROP	102	4
238	STAR THEME	103	2
239	SPACE PAD	103	8
240	DANCE SAW PAD	90	48
241	DANCE SQUARE PAD 1	90	49
242	DANCE SQUARE PAD 2	90	50
INDIAN			
243	SITAR 1	104	2
244	SITAR 2	104	3
245	TANPURA 1	104	32
246	TANPURA 2	104	33
247	HARMONIUM 1	20	32
248	HARMONIUM 2	20	33
249	SHANAI 1	111	2
250	SHANAI 2	111	3
251	SANTUR 1	15	3
252	SANTUR 2	15	4
253	TABLA	116	16
ETHNIC			
254	YANG QIN 1	15	8
255	YANG QIN 2	15	9
256	DI ZI	72	16
257	ZHENG	107	1
258	SHENG	109	8
259	SUO NA	111	32
260	XIAO	77	32
261	PI PA	105	32
262	BANJO	105	2
263	THUMB PIANO	108	2
264	STEEL DRUMS	114	2
265	RABAB	105	8
266	KOTO	107	2
GM TONES			
267	GM PIANO 1	0	0
268	GM PIANO 2	1	0
269	GM PIANO 3	2	0
270	GM HONKY-TONK	3	0
271	GM E.PIANO 1	4	0

No.	Tone Name	Program Change	Bank Select MSB
272	GM E.PIANO 2	5	0
273	GM HARPSICHORD	6	0
274	GM CLAVI	7	0
275	GM CELESTA	8	0
276	GM GLOCKENSPIEL	9	0
277	GM MUSIC BOX	10	0
278	GM VIBRAPHONE	11	0
279	GM MARIMBA	12	0
280	GM XYLOPHONE	13	0
281	GM TUBULAR BELL	14	0
282	GM DULCIMER	15	0
283	GM ORGAN 1	16	0
284	GM ORGAN 2	17	0
285	GM ORGAN 3	18	0
286	GM PIPE ORGAN	19	0
287	GM REED ORGAN	20	0
288	GM ACCORDION	21	0
289	GM HARMONICA	22	0
290	GM BANDONEON	23	0
291	GM NYLON STR.GUITAR	24	0
292	GM STEEL STR.GUITAR	25	0
293	GM JAZZ GUITAR	26	0
294	GM CLEAN GUITAR	27	0
295	GM MUTE GUITAR	28	0
296	GM OVERDRIVE GUITAR	29	0
297	GM DISTORTION GUITAR	30	0
298	GM GUITAR HARMONICS	31	0
299	GM ACOUSTIC BASS	32	0
300	GM FINGERED BASS	33	0
301	GM PICKED BASS	34	0
302	GM FRETLESS BASS	35	0
303	GM SLAP BASS 1	36	0
304	GM SLAP BASS 2	37	0
305	GM SYNTH-BASS 1	38	0
306	GM SYNTH-BASS 2	39	0
307	GM VIOLIN	40	0
308	GM VIOLA	41	0
309	GM CELLO	42	0
310	GM CONTRABASS	43	0
311	GM TREMOLO STRINGS	44	0
312	GM PIZZICATO	45	0
313	GM HARP	46	0
314	GM TIMPANI	47	0
315	GM STRINGS 1	48	0
316	GM STRINGS 2	49	0
317	GM SYNTH-STRINGS 1	50	0
318	GM SYNTH-STRINGS 2	51	0
319	GM CHOIR AAHS	52	0
320	GM VOICE DOO	53	0
321	GM SYNTH-VOICE	54	0
322	GM ORCHESTRA HIT	55	0
323	GM TRUMPET	56	0
324	GM TROMBONE	57	0
325	GM TUBA	58	0
326	GM MUTE TRUMPET	59	0
327	GM FRENCH HORN	60	0
328	GM BRASS	61	0
329	GM SYNTH-BRASS 1	62	0
330	GM SYNTH-BRASS 2	63	0
331	GM SOPRANO SAX	64	0
332	GM ALTO SAX	65	0
333	GM TENOR SAX	66	0
334	GM BARITONE SAX	67	0
335	GM OBOE	68	0
336	GM ENGLISH HORN	69	0
337	GM BASSOON	70	0
338	GM CLARINET	71	0
339	GM PICCOLO	72	0
340	GM FLUTE	73	0
341	GM RECORDER	74	0
342	GM PAN FLUTE	75	0
343	GM BOTTLE BLOW	76	0
344	GM SHAKUHACHI	77	0

No.	Tone Name	Program Change	Bank Select MSB
345	GM WHISTLE	78	0
346	GM OCARINA	79	0
347	GM SQUARE LEAD	80	0
348	GM SAW LEAD	81	0
349	GM CALLIOPE	82	0
350	GM CHIFF LEAD	83	0
351	GM CHARANG	84	0
352	GM VOICE LEAD	85	0
353	GM FIFTH LEAD	86	0
354	GM BASS+LEAD	87	0
355	GM FANTASY	88	0
356	GM WARM PAD	89	0
357	GM POLYSYNTH	90	0
358	GM SPACE CHOIR	91	0
359	GM BOWED GLASS	92	0
360	GM METAL PAD	93	0
361	GM HALO PAD	94	0
362	GM SWEEP PAD	95	0
363	GM RAIN DROP	96	0
364	GM SOUND TRACK	97	0
365	GM CRYSTAL	98	0
366	GM ATMOSPHERE	99	0
367	GM BRIGHTNESS	100	0
368	GM GOBLINS	101	0
369	GM ECHOES	102	0
370	GM SF	103	0
371	GM SITAR	104	0
372	GM BANJO	105	0
373	GM SHAMISEN	106	0
374	GM KOTO	107	0
375	GM THUMB PIANO	108	0
376	GM BAGPIPE	109	0
377	GM FIDDLE	110	0
378	GM SHANAI	111	0
379	GM TINKLE BELL	112	0
380	GM AGOGO	113	0
381	GM STEEL DRUMS	114	0
382	GM WOOD BLOCK	115	0
383	GM TAIKO	116	0
384	GM MELODIC TOM	117	0
385	GM SYNTH-DRUM	118	0
386	GM REVERSE CYMBAL	119	0
387	GM GUITAR FRET NOISE	120	0
388	GM BREATH NOISE	121	0
389	GM SEASHORE	122	0
390	GM BIRD	123	0
391	GM TELEPHONE	124	0
392	GM HELICOPTER	125	0
393	GM APPLAUSE	126	0
394	GM GUNSHOT	127	0
DRUM SET			
395	STANDARD SET 1	0	120
396	STANDARD SET 2	1	120
397	DANCE SET	29	120
398	BRUSH SET	40	120
399	ORCHESTRA SET	48	120
400	INDIAN SET	49	120

Drum Assignment List

Key	Note No.	DRUMS SET NAME					
		STANDARD SET 1	STANDARD SET 2	DANCE SET	BRUSH SET	ORCHESTRA SET	INDIAN SET
C-1	0						
D-1	1						
E-1	2						
F-1	3						
G-1	4						
A-1	5						
B-1	6						
C0	7						
D0	8						
E0	9						
F0	10						
G0	11						
A0	12						
B0	13						
C1	14						
D1	15						
E1	16						
F1	17						
G1	18						
A1	19						
B1	20						
C2	21						
D2	22						
E2	23						
F2	24						
G2	25						
A2	26						
B2	27						
C3	28						
D3	29						
E3	30						
F3	31						
G3	32						
A3	33						
B3	34						
C4	35						
D4	36						
E4	37						
F4	38						
G4	39						
A4	40						
B4	41						
C5	42						
D5	43						
E5	44						
F5	45						
G5	46						
A5	47						
B5	48						
C6	49						
D6	50						
E6	51						
F6	52						
G6	53						
A6	54						
B6	55						
C7	56						
D7	57						
E7	58						
F7	59						
G7	60						
A7	61						
B7	62						
C8	63						
D8	64						
E8	65						
F8	66						
G8	67						
A8	68						
B8	69						
C9	70						
D9	71						
E9	72						
F9	73						
G9	74						
	75						
	76						
	77						
	78						
	79						
	80						
	81						
	82						
	83						
	84						
	85						
	86						
	87						
	88						
	89						
	90						
	91						
	92						
	93						
	94						
	95						
	96						
	97						
	98						
	99						
	100						
	101						
	102						
	103						
	104						
	105						
	106						
	107						
	108						
	109						
	110						
	111						
	112						
	113						
	114						
	115						
	116						
	117						
	118						
	119						
	120						
	121						
	122						
	123						
	124						
	125						
	126						
	127						

• “←” indicates a key is assigned the same tones as it is for STANDARD SET 1.

Song List

No.	Title
PIANO/CLASSICS	
1	FÜR ELISE
2	VALSE op.64 no.1 "PETIT CHIEN"
3	TURKISH MARCH (MOZART)
4	TRÄUMEREI
5	ÉTUDE op.10 no.3 "CHANSON DE L'ADIEU"
6	LIEBESTRÄUME no.3
7	NOCTURNE op.9 no.2 (CHOPIN)
8	CANON (PACHELBEL)
9	MARY HAD A LITTLE LAMB
10	LE CYGNE FROM "LE CARNAVAL DES ANIMAUX"
11	AIR FROM "SUITE no.3"
12	SPRING FROM "THE FOUR SEASONS"
13	HUNGARIAN DANCES no.5
14	MINUET IN G MAJOR
15	GAVOTTE (GOSSEC)
16	ARABESQUE (BURGMÜLLER)
17	DECK THE HALL
18	ODE TO JOY
19	AVE MARIA (GOUNOD)
20	PRELUDE op.28 no.7 (CHOPIN)
21	GOING HOME FROM "FROM THE NEW WORLD"
22	SONATA op.27 no.2 "MOONLIGHT" 1st Mov.
23	THE ENTERTAINER
24	FRÖHLICHER LANDMANN
25	LA CHEVALERESQUE
26	JESUS BLEIBET MEINE FREUDE
27	MARCH FROM "THE NUTCRACKER"
28	CHANSON DU TOREADOR FROM "CARMEN"
29	INVENTIONEN no.1
30	PRAELUDIUM no.1 (J.S.BACH)
EVENT	
31	SILENT NIGHT
32	JINGLE BELLS
33	WE WISH YOU A MERRY CHRISTMAS
34	JOY TO THE WORLD
35	O CHRISTMAS TREE
WORLD	
36	WHEN THE SAINTS GO MARCHING IN
37	GREENSLEEVES
38	ANNIE LAURIE
39	AMAZING GRACE
40	TWINKLE TWINKLE LITTLE STAR
41	GRANDFATHER'S CLOCK
42	ON TOP OF OLD SMOKEY
43	COME BIRDS
44	DID YOU EVER SEE A LASSIE?
45	DANNY BOY
46	MY BONNIE
47	HOME SWEET HOME
48	AURA LEE
49	ALOHA OE
50	LONDON BRIDGE
51	UNDER THE SPREADING CHESTNUT TREE
52	SIPPIN' CIDER THROUGH A STRAW
53	BEAUTIFUL DREAMER
54	MY DARLING CLEMENTINE
55	LITTLE BROWN JUG
56	YANKEE DOODLE
57	I'VE BEEN WORKING ON THE RAILROAD
58	OH! SUSANNA
59	TURKEY IN THE STRAW
60	FURUSATO

Dance Music Mode List

No.	Pattern Name
EDM	
1	ELECTRO DANCE 1
2	ELECTRO DANCE 2
3	ELECTRO DANCE 3
4	BIG BEAT TECHNO 1
5	BIG BEAT TECHNO 2
6	SPEED SHUFFLE 1
7	SPEED SHUFFLE 2
8	POP TRANCE 1
9	POP TRANCE 2
10	SLOW SOUL 1
11	DIGITAL SHUFFLE 1
12	DIGITAL SHUFFLE 2
13	POWER POP 1
14	POWER POP 2
15	POWER POP 3
16	NEO TRANCE 1
17	NEO TRANCE 2
18	HARD SHUFFLE 1
19	HARD SHUFFLE 2
20	ELECTRO BOUNCE 1
21	ELECTRO BOUNCE 2
22	POWER ELECTRO 1
23	POWER ELECTRO 2
24	ACID DANCE
25	POWER DANCE 1
26	POWER DANCE 2
27	FUTURE DANCE
28	DANCE RAGGA
29	ACID ELECTRO 1
30	ACID ELECTRO 2
31	HARD ELECTRO
32	ACID TECHNO 1
33	ACID TECHNO 2
34	FANTASTIC DANCE
35	FUTURE POP
HOUSE	
36	ELECTRIC POP
37	DIGITAL SHUFFLE 3
38	POP DANCE 1
39	POP DANCE 2
40	FUTURE HOUSE 1
41	FUTURE HOUSE 2
42	SPEED HOUSE 1
43	SPEED HOUSE 2
44	URBAN DANCE 1
45	URBAN DANCE 2
HIP-HOP	
46	DEEP SOUL 1
47	DEEP SOUL 2
48	SLOW SOUL 2
49	ELECTRO BOUNCE 3
50	ELECTRO RAGGA

Rhythm List

No.	Rhythm name
8 BEAT	
1	STRAIGHT 8 BEAT
2	8 BEAT
16 BEAT	
3	16 BEAT
4	16 BEAT SHUFFLE 1
5	16 BEAT SHUFFLE 2
BALLAD	
6	MODERN BALLAD
7	16 BEAT BALLAD
8	POP BALLAD
9	6/8 BALLAD
DANCE	
10	EDM 1
11	EDM 2
12	DISCO POP
13	MODERN R&B
POPS	
14	POP
15	POP ROCK
16	60's SOUL
ROCK	
17	STRAIGHT ROCK
18	SHUFFLE ROCK
19	SLOW ROCK
20	ROCK WALTZ
JAZZ	
21	BIG BAND
22	SLOW SWING
23	JAZZ WALTZ
24	FOX TROT
EUROPEAN	
25	POLKA
26	WALTZ 1
27	SLOW WALTZ
28	VIENNESE WALTZ
29	FRENCH WALTZ
30	TANGO
31	MARCH 1
32	MARCH 2
LATIN	
33	BOSSA NOVA
34	SAMBA
35	MAMBO
36	RHUMBA
37	CHA-CHA-CHA
38	MERENGUE
39	BOLERO
40	SALSA
41	REGGAE
42	POP REGGAE
43	SKA
44	CUMBIA
INDIAN	
45	BHANGRA
46	DADRA
47	GARBA
48	KEHARWA
49	TEEN TAAL
50	DANDIYA

No.	Rhythm name
51	BHAJAN
52	INDIAN POP 1
53	INDIAN POP 2
54	INDIAN POP 3
55	INDIAN POP 4
56	QAWWALI
57	KERALA
58	RAJASTHANI
WORLD	
AMERICAN	
59	COUNTRY BALLAD
60	BLUEGRASS
61	DIXIE
62	TEX-MEX
63	FAST GOSPEL
64	HAWAIIAN
EASTERN EUROPEAN	
65	RUSSIAN CHANSON
ARABIC	
66	ADANI
CHINESE	
67	JIANGNAN
68	DONGBEIYANGGE
69	JINGJU
70	HUANGMEIXI
71	MIAOZU
72	XINJIANG
INDONESIAN	
73	DANGDUT
VARIOUS	
74	CHRISTMAS WALTZ
75	STRING QUARTET
PIANO RHYTHMS	
76	ARPEGGIO
77	WALTZ 2

Fingering Guide

■ FINGERED 1, FINGERED 2 Chords

C	
Cm	
Cdim	
Caug *3	
C^b5	
Csus4 *3	
Csus2 *3	
C7	
Cm7 *3	
CM7	
CmM7	
Cdim7 *3	
CdimM7	
C7^b5 *3	
Cm7^b5 *3	
CM7^b5	
Caug7	
CaugM7	
C7sus4	
C6 *1 *3	
Cm6 *2 *3	

Cadd9	
Cmadd9	
C69 *3	
Cm69 *3	

*1 With FINGERED 2, interpreted as Am7.

*2 With FINGERED 2, interpreted as Am7^b5.

*3 Inverted form not supported in some cases.

*4 These fingerings are special fingerings for Digital Keyboard chord input, and so they are not suitable for normal keyboard play.

■ FINGERED ON BASS, FULL RANGE CHORD

In addition to the chords that can be fingered with FINGERED 1 and FINGERED 2, the chords below are recognized.

$\frac{C\#}{C}$	$\frac{D}{C}$	$\frac{F}{C}$	$\frac{F\#}{C}$	$\frac{G}{C}$	$\frac{A^b}{C}$	$\frac{A}{C}$	$\frac{B^b}{C}$	$\frac{C\#m}{C}$	$\frac{Dm}{C}$	$\frac{Fm}{C}$
$\frac{F\#m}{C}$	$\frac{Gm}{C}$	$\frac{A^bm}{C}$	$\frac{Am}{C}$	$\frac{B^bm}{C}$	$\frac{Bm}{C}$	$\frac{C\#dim}{C}$	$\frac{Ddim}{C}$			
$\frac{Fdim}{C}$	$\frac{F\#dim}{C}$	$\frac{Gdim}{C}$	$\frac{A^bdim}{C}$	$\frac{Adim}{C}$	$\frac{Bdim}{C}$	$\frac{F7}{C}$	$\frac{A^b7}{C}$			
$\frac{Fm7}{C}$	$\frac{FM7}{C}$	$\frac{A^bM7}{C}$	$\frac{F\#m7^b5}{C}$	$\frac{Gm7}{C}$	$\frac{G7}{C}$	$\frac{A^badd9}{C}$				

NOTE

- With FINGERED ON BASS, the lowest note fingered is interpreted as the base note. Inverted forms are not supported.
- With FULL RANGE CHORD, when the lowest note fingered is a certain distance from the neighboring note, the chord is interpreted as a fraction chord.
- Unlike FINGERED 1, 2, and FINGERED ON BASS, FULL RANGE CHORD requires pressing of at least three keys to form a chord.

Chord Example List

*1 *2	C	C [#] /(D ^b)	D	(D [#])/E ^b	E	F
M						
m						
dim						
aug						
sus4						
sus2						
7						
m7						
M7						
m7 ^b 5						
7 ^b 5						
7sus4						
add9						
madd9						
mM7						
dim7						
69						
6						
m6						

*1 Root *2 Chord Type

- Since the chord input range is limited, this model may not support some of the chords shown above.

*1 \ *2	F#/(G \flat)	G	(G#)/A \flat	A	(A#)/B \flat	B
M						
m						
dim						
aug						
sus4						
sus2						
7						
m7						
M7						
m7 \flat 5						
7 \flat 5						
7sus4						
add9						
madd9						
mM7						
dim7						
6/9						
6						
m6						

*1 Root *2 Chord Type

- Since the chord input range is limited, this model may not support some of the chords shown above.

MIDI Implementation Chart

Function	Transmitted	Recognized	Remarks
Basic Channel Default Changed	1 1 - 16	1 - 16 1 - 16	
Mode Default Messages Altered	Mode 3 X * * * * * * * * * *	Mode 3 X * * * * * * * * * *	
Note Number True voice	0 - 127 * * * * * * * * * *	0 - 127 0 - 127 *1	
Velocity Note ON Note OFF	0 9nH v = 1 - 127 X 8nH v = 64	0 9nH v = 1 - 127 X 9nH v = 0, 8nH v = **	***: no relation
After Touch Key's Ch's	X X	X O	
Pitch Bender	X	O	
Control Change 0 1 5 6, 38 7 10 11 64 65 66	O X X X X X X X X X X O *3 X O *3	O O O *2 O O O O O O O O O O	Bank select Modulation Portamento Time Data entry LSB/MSB Volume Pan Expression Hold 1 Portamento Switch Sostenuto

67 71 72 73 74 84 91 100, 101		O *3 X O X X X X X		O O O O O O O *2 O *2	Soft pedal Filter resonance Release time Attack time Brightness Portamento Control Reverb send level RPN LSB/MSB
Program Change	True #	O *** ** ** ** **		O 0 - 127	
Exclusive		O *2		O *2	
System Common	Song Pos Song Sel Tune	X X X		X X X	
System Real Time	Clock Commands	X X		X X	
Aux Messages	All sound off Reset all controller Local ON/OFF All notes OFF Active Sense System Reset	X X X X X X		O O X O O X	
Remarks	*1: Depends on tone. *2: For details about RPN and system exclusive messages, see MIDI Implementation at https://support.casio.com/global/en/manual/CF-S200/ *3: In accordance with pedal effect setting.				

Mode 1 : OMNI ON, POLY
Mode 3 : OMNI OFF, POLY

Mode 2 : OMNI ON, MONO
Mode 4 : OMNI OFF, MONO

O : Yes
X : No

CASIO®

CASIO COMPUTER CO., LTD.
6-2, Hon-machi 1-chome
Shibuya-ku, Tokyo 151-8543, Japan

MA1908-A
© 2019 CASIO COMPUTER CO., LTD.