

Thank you for choosing the **JTS®** condenser microphones. In order to obtain the best efficiency for your performance, you are recommended to take few minutes to read this instruction manual carefully.

CM-501 Condenser lavalier microphone

Features

- The wide dynamic range and frequency response ensure clean, accurate sound reproduction.
- There are 2 capsules type for choosing: uni-direction polar pattern and omni-direction polar pattern.
- The Uni-direction polar pattern ensures the best gain-before-feedback and with the omni-direction polar pattern, the microphone provides a natural sound effectively.
- The built-in power module provide easy operation.

Use Instruction

1. Attach a lavalier microphone to the proper position of a speaker's jacket or dress. (Figure 1)
2. The optimal distance of sound pickup between sound source and lavalier microphone is within 5 ". (Figure 2)
3. Slip the windscreen on the head of microphone to reduce wind noise or popping noise. (Figure 3)

Specifications

Polar pattern	Uni-direction				Omni-direction			
	3P XLR	MINI 3P XLR	Ø3.5mm Plug	MINI 4P XLR	3P XLR	MINI 3P XLR	Ø3.5mm Plug	MINI 4P XLR
Output connector	3P XLR	MINI 3P XLR	Ø3.5mm Plug	MINI 4P XLR	3P XLR	MINI 3P XLR	Ø3.5mm Plug	MINI 4P XLR
Freq. response	100 ~ 12,000Hz	100 ~ 12,000Hz	100 ~ 12,000Hz	100 ~ 12,000Hz	100 ~ 12,000Hz	100 ~ 12,000Hz	100 ~ 12,000Hz	100 ~ 12,000Hz
Impedance	220Ω ± 30%	2.2kΩ ± 30%	2.2kΩ ± 30%	2.2kΩ ± 30%	220Ω ± 30%	2.2kΩ ± 30%	2.2kΩ ± 30%	2.2kΩ ± 30%
Sensitivity(at 1,000Hz)	-60±3dB	-70±3dB	-70±3dB	-70±3dB	-60±3dB	-62±3dB	-62±3dB	-62±3dB
Max. SPL for 1% THD	130dB	130dB	130dB	130dB	130dB	130dB	130dB	130dB
Accessories	Clothing clip, Windscreen	Clothing clip, Windscreen	Clothing clip, Windscreen	Clothing clip, Windscreen	Clothing clip, Windscreen	Clothing clip, Windscreen	Clothing clip, Windscreen	Clothing clip, Windscreen

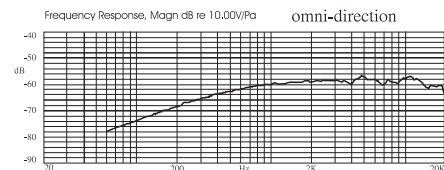
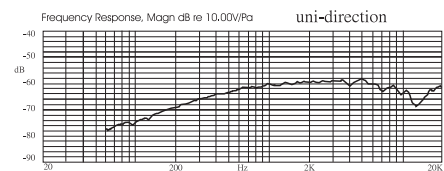

Dimension

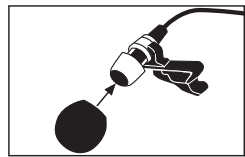
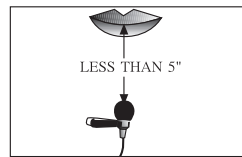
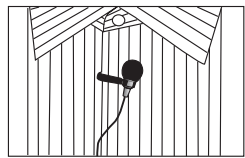
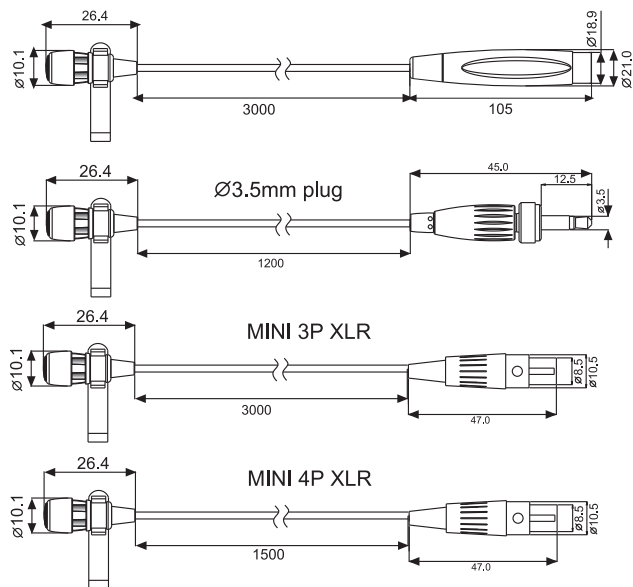

CM-502 Condenser hanging microphone

Features

- The CM-502 is a condenser microphone with a supercardioid polar pattern, it features wide dynamic range and frequency response for accurate sound reproduction.
- High sensitivity allows sound pickup smartly.
- Attaching flexible mic. hanger benefits microphone in the proper orient of sound source.

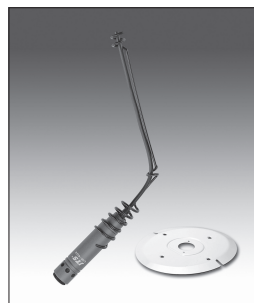

Installation of mounting plate

1. Pass microphone through the hole in the center of mounting plate as (Figure 1).
2. Adhere the sticker to the reserve side of the plate to cover the hole. Pass cable through one fissure on the sticker and adhere the sticker to the relief outline on the plate center. (Figure 2)
3. Select the suitable cable length, then pass the cable through the chip at the plate rim, finally fix the plate on the ceiling or wall by 4 screws. (Figure 4)

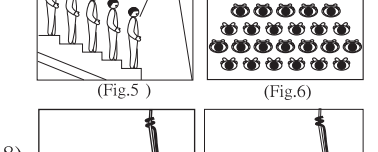
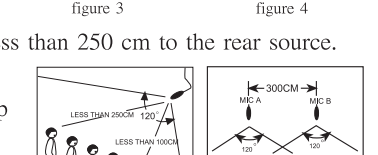
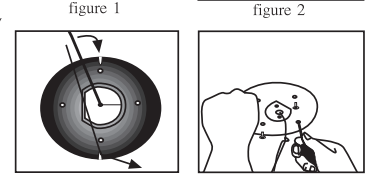
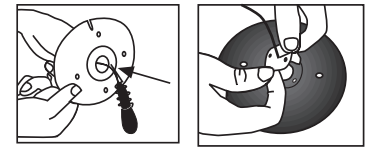

Use Installation

[1.] To find out the best position for fixing microphone.

- The optimum sound accepting range is within 120° in horizontal space. (Fig.5)
- Proper distance between microphone and front sound source is less than 100 cm, and less than 250 cm to the rear source. (Fig.5)
- If more than 2 microphones will be used simultaneously in the same environment, keep the latter microphone 300 cm far from the former one. (Fig.6)
- To aim the microphone between the front source and the rear source for well-balanced sound pickup.

[2.] To wind the wire around flexible hanger for holding microphone toward the suitable direction. (Fig.7)

[3.] To slip windscreen over the head of microphone for prevent breath or popping noise. (Fig.8)

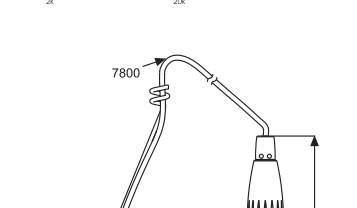
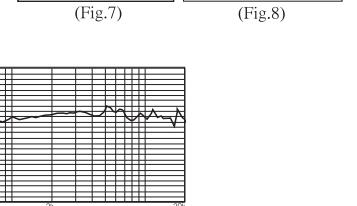
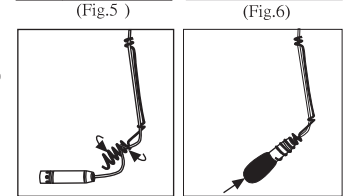
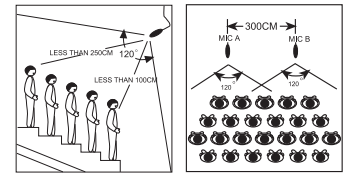

Specifications

Output connector	3P XLR	MINI 3P XLR	Ø3.5mm Plug
Freq. response	100 ~ 18,000Hz	100 ~ 18,000Hz	100 ~ 18,000Hz
Polar pattern	Supercardioid	Supercardioid	Supercardioid
Impedance	220Ω ± 30%	2k ± 30%	2k ± 30%
Sensitivity(at 1,000Hz)	-48±3dB	-66±3dB	-66±3dB
Max. SPL for 1% THD	125dB	125dB	125dB
Accessories	Mic. hanger , Windscreen	Mic. hanger , Windscreen	Mic. hanger , Windscreen

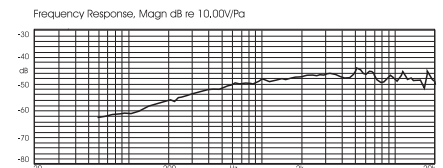

Dimension

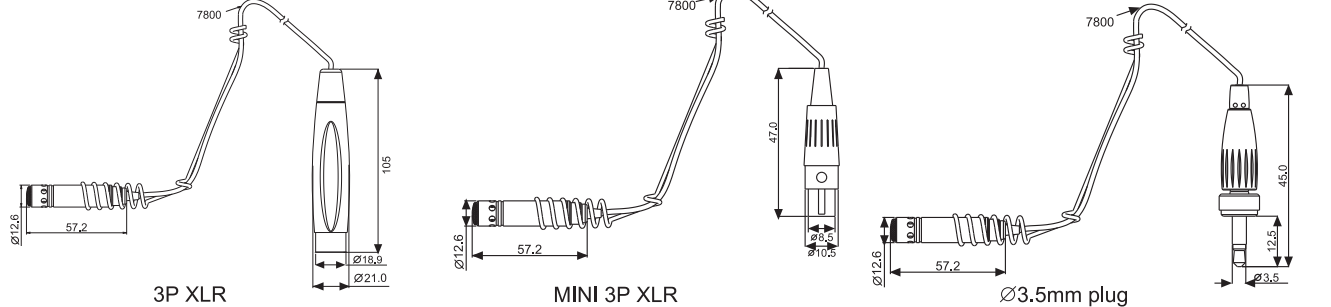

CX-506 Condenser drum & percussion microphone

Features

- CX-506 features a frequency response specially designed for drum and percussion miking.
- Clamp with elastic grip benefits secure holding but causes no damage on the instrument.
- Self-contained electronics eliminate need of external power modules.

Use Instruction

1. Clamp the microphone to the ring of the drum. (Figure 1)
2. Adjust the mic. shaft to aim microphone at precise sound source position, recommended distance between the microphone and the drum surface is 2 inches. (Figure 2)
3. Slip the windscreen on the head of microphone to reduce wind noise effectively. (Figure 3)

