

# ClearOne®

## **BMA CT**

Beamforming Mic Array - Ceiling-Tile

## Quick-Start Guide

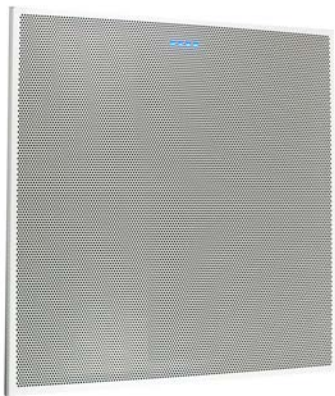

# Table of Contents

<b>IMPORTANT SAFETY INSTRUCTIONS</b> .....	<b>1</b>
<b>THE BMA CT</b> .....	<b>2</b>
<b>QUICK-START OVERVIEW</b> .....	<b>3</b>
<b>CONNECTING THE ARRAYS</b> .....	<b>4</b>
I/O CONNECTIONS .....	4
P-LINK CONNECTIONS.....	6
<b>UPDATING ARRAY FIRMWARE</b> .....	<b>8</b>
<b>TESTING THE ARRAYS</b> .....	<b>8</b>
VOLUME & MUTE.....	8
MICROPHONE ARRAY LED INDICATORS .....	8
MICROPHONE ARRAY ORIENTATION .....	9
<b>MOUNTING THE ARRAYS</b> .....	<b>10</b>
PLENUM SHIELD WITH SEISMIC CABLES .....	10
PLENUM SHIELD INSTALLATION .....	11
SEISMIC CABLES .....	12
<b>COMPLIANCE</b> .....	<b>13</b>
PART NUMBERS .....	13
SUPPORTED CONVERGE PRO 2 .....	13
<b>ISOMETRIC DIAGRAMS</b> .....	<b>14</b>
<b>SUPPORTED CONVERGE PRO 2</b> .....	<b>15</b>



### IMPORTANT SAFETY INSTRUCTIONS

1. Read these instructions.
2. Keep these instructions.
3. Heed all warnings.
4. Follow all instructions.
5. Do not use this apparatus near water.
6. Clean only with dry cloth.
7. Do not block any ventilation openings. Install in accordance with the manufacturer's instructions.
8. Do not install near any heat sources such as radiators, heat registers, stoves, or other apparatus (including amplifiers) that produce heat.
9. Do not defeat the safety purpose of the polarized or grounding-type plug. A polarized plug has two blades with one wider than the other. A grounding type plug has two blades and a third grounding prong. The wide blade or the third prong are provided for your safety. If the provided plug does not fit into your outlet, consult an electrician for replacement of the obsolete outlet.
10. Only use attachments/accessories specified by the manufacturer.
11. Unplug the array during lightning storms or when unused for long periods of time.
12. Refer all servicing to qualified service personnel. Servicing is required when the apparatus has been damaged in any way, such as power-supply cord or plug is damaged, liquid has been spilled or objects have fallen into the apparatus, the apparatus has been exposed to rain or moisture, does not operate normally, or has been dropped.
13. Protect the PoE injector's power cord from being walked on or pinched; particularly at plugs, convenience receptacles, and the point where they exit from the apparatus.



## BMA CT

### THE BMA CT

The BMA CT is a 2nd-generation Beamforming Microphone Array solution for ceiling-tile installations, featuring 24 microphones, and beamforming and adaptive-steering technology (think of it as smart beam selection) designed specifically for the CONVERGE® Pro 2 (CP2) products: 128, 128D, 128T, 128TD, 128V, 128VD, 128VT, 128VTD, 120, 48T, 48VT, 48VTD, and 48V. The arrays connect with the CONVERGE Pro 2 through a Peripheral Link (P-Link) port with either Regular (200 ft.) or Long Distance (650 ft.) P-Link cables. Three arrays are supported per CP2 via either regular or long-distance P-Link, and up to 6 arrays can be daisy-chained in one regular P-Link chain with a stack of two CP2 mixers. Power to the arrays is supplied through a Power-Over-Ethernet (PoE) or P-Link connection from CP2. The array comes in both a 24-inch and 600mm size. There is also an adapter that converts the 600mm version to 625mm.

**IMPORTANT:** The BMA CT arrays can only be used with CP2 systems. It is not compatible with CONVERGE Pro or first-generation Beamforming Mic Array systems.

The latest version of the CP2 firmware and software can be found on the ClearOne website at:

**<http://www.clearone.com/resource-product-line?pid=1029>**

The latest version of the BMA CT firmware and Installation Guide can be found on the ClearOne website at:

**<http://www.clearone.com/resource-product-line?pid=1030>**

### QUICK-START OVERVIEW

Installing and using the BMA CT arrays in your CP2 site is subject to the following parameters:

1. The arrays can only be used with CP2 systems.
2. You must have a 128, 128D, 128T, 128TD, 128V, 128VD, 128VT, 128VTD, 120, 48T, 48VT, 48VTD, and/or 48V. mixer in the site. The arrays will not work with standalone 012, 128SR, or 128SRD units.
3. Connect up to 3 arrays (current) per CP2 unit, and up to 6 arrays per Regular P-Link chain with 2 CP2 unit stack. More CP2 units may be added to increase the number of arrays per site.

### QUICK-START PROCEDURES

These steps must be done in the following order to use the BMA CT in your CONVERGE Pro 2 site:

1. Update the CONVERGE Pro 2 firmware to the latest version using CONVERGE Pro 2 CONSOLE software.
2. Connect the array to the updated CONVERGE Pro 2 via the P-Link bus.
3. Update the array firmware using CONVERGE Pro 2 CONSOLE. (The array firmware can not be upgraded without an updated CONVERGE Pro 2.)
4. Test the array.
5. Mount the array.

## BMA CT

### CONNECTING THE ARRAYS

Connect the BMA CT units to the CP2 unit via P-Link connections using CAT6-24AWG solid conductor RJ45 cables.

#### I/O CONNECTIONS

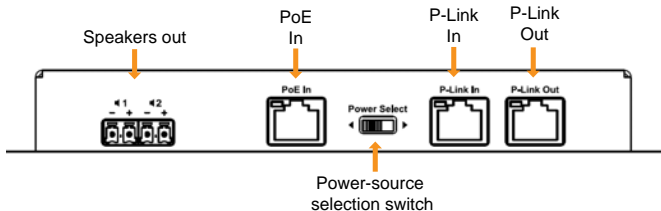

The arrays must be powered by an external PoE source that supports Mode B type power delivery. (A PoE Network Switch generally will not work for this.) A PoE injector can either be connected to P-Link PoE port on the rack-mounted CP2 unit, or it can be connected directly to the array's PoE In port.

When driving 2x10W speakers, each array requires its own PoE injector.

When the PoE injector is connected to the CP2 unit's P-Link PoE port, the CP2 unit's P-Link Out port will provide both power and data communications to the array. If the PoE injector is connected directly to the array PoE In port, a second cable must be connected from the CP2 unit's P-Link Out port to the array P-Link In port. (Note that the CP2 unit itself does not provide PoE power without an external PoE injector.)

## QUICK-START GUIDE

ClearOne PoE power supply part number 910-3200-202 is recommended, and will power up to three P-Link devices. Some third-party PoE injectors will work, but not all. Mode B PoE injectors that meet the PoE IEEE 802.3at specification should power three devices.

See also this app note:

[http://www.clearone.com/sites/default/files/PoE\\_and\\_CP2\\_P-link\\_Peripheral\\_Products.pdf](http://www.clearone.com/sites/default/files/PoE_and_CP2_P-link_Peripheral_Products.pdf)

The power-source-selection switch should be set towards PoE if the array is powered by PoE, or set towards P-Link if powered by P-Link.

### **SPEAKER USAGE**

When driving 2x10W speakers, each array requires its own PoE injector. Set the “Power Select” switch to “PoE In” when the speaker outputs will be used.

# BMA CT

## P-LINK CONNECTIONS

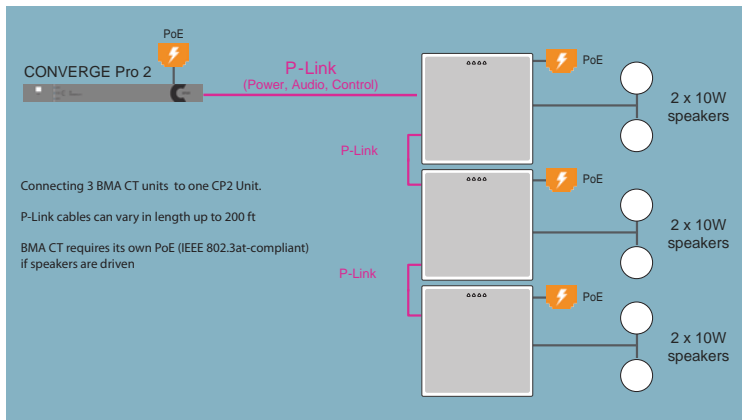



# QUICK-START GUIDE

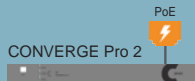

Connecting 3 BMA CT units and 3 P-Link compatible devices to one CP2 unit.

**P-Link**  
(Power, Audio, Control)

Up to 200 ft.

**P-Link**  
Up to 200 ft.

**P-Link**  
Up to 200 ft.

**P-Link**  
Up to 200 ft.

**P-Link**  
Up to 200 ft.

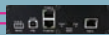

## **BMA CT**

### **UPDATING ARRAY FIRMWARE**

1. Connect the P-Link cable between the CP2 units and the arrays.
2. Connect the CP2 units with CONVERGE Pro 2 CONSOLE.
3. Open the Firmware Loader screen.
4. Browse for the BMA\_CT\_vx.x.x.x.mdo file.
5. Download the array firmware.
6. The array(s) will default and reboot after the download of firmware.
7. Units are fully upgraded. (All array units connected via the P-Link on the site are simultaneously updated.)

### **TESTING THE ARRAYS**

The array must be added to the site using the CONVERGE Pro 2 CONSOLE software. This software also provides the capability of configuring the beams (enable/disable) and other characteristics available in Configuration mode. Refer to the online help available with the CONVERGE Pro 2 CONSOLE software.

### **VOLUME & MUTE**

These controls are available through the controller configured for your CONVERGE Pro 2 site.

### **MICROPHONE ARRAY LED INDICATORS**

The illuminated LED indicators on the face of the array change color when the microphone array is active/muted. You can choose colors to indicate either state, or even set the indicators to remain off by using CONVERGE Pro 2 CONSOLE to change Unit Properties for the array.

## QUICK-START GUIDE

### MICROPHONE ARRAY ORIENTATION

The LED indicators should be oriented in the room according to the beam selection needs for optimal coverage. The diagrams below show the orientation of the LED indicators toward the head of the conference table with the resulting room coverage and beam mapping shown below. Please be certain to remove the orientation label from the perforated room panel before use.

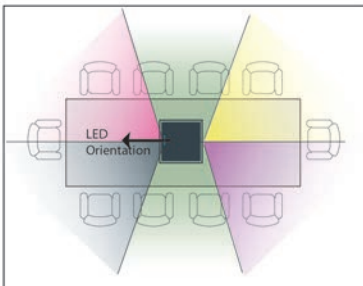
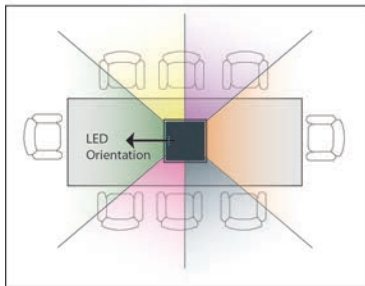
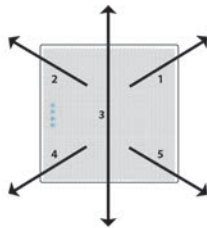
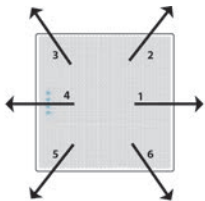

## BMA CT

### MOUNTING THE ARRAYS

#### PLENUM SHIELD WITH SEISMIC CABLES

If installing both the plenum shield and seismic cables, four slots of approximately 1" length should be cut diagonally in the plenum shielding to match the points of seismic cable attachment. Otherwise, skip this step and go to page 11 for installation of plenum shield only or page 12 for installation of seismic cables only.

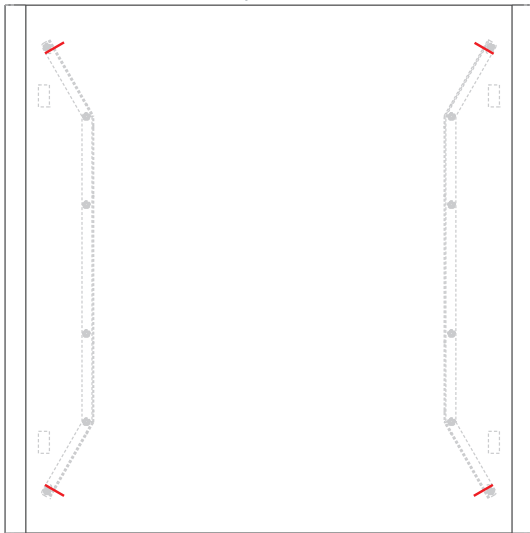

### PLENUM SHIELD INSTALLATION

Remove the liner from adhesive in four places on underside of shielding, and thread cables through cut slots before attaching to ceiling.

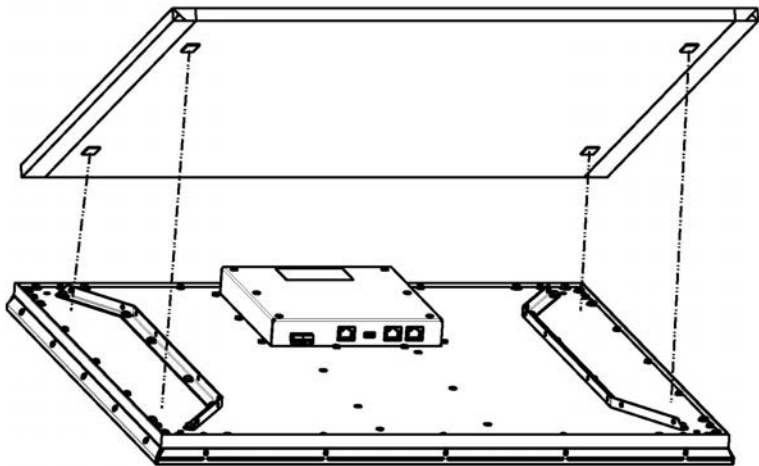

## BMA CT

### SEISMIC CABLES INSTALLATION

The array can be ceiling-mounted in a suspended ceiling, held in place by the standard T-BAR grid, with additional 1/8" safety (seismic) cables (not included). Four attachment points are recommended for stability. If installing with the plenum shield, feed cables thru slots cut in earlier step (see Pg 10).

Detailed instructions are included in the BMA CT Installation Guide available on the ClearOne website:

**<http://www.clearone.com/resource-product-line?pid=1030>**

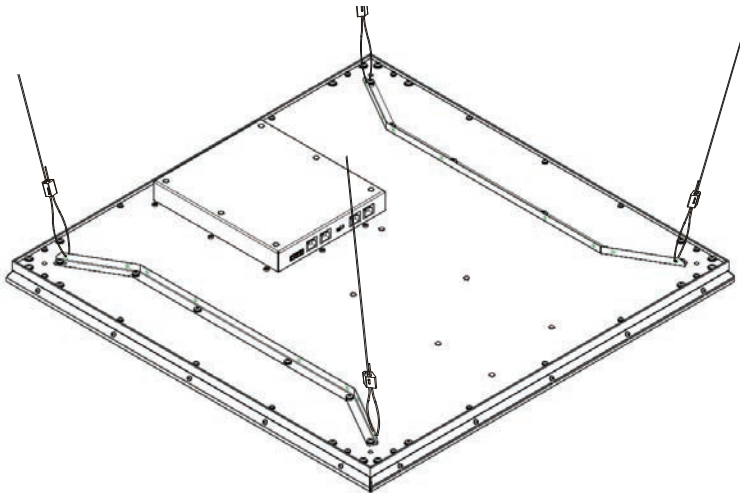

**COMPLIANCE**

Details on compliance can be found on the ClearOne website under “Resource Library”.

**Part Numbers**

Item	Part No.
White BMA CT 24”	910-3200-205
White BMA CT 600mm	910-3200-205-l
PoE Power Supply Kit	910-3200-202
50 Ft RJ45 CAT6 Cable	910-3200-204-50
100 Ft RJ45 CAT6 Cable	910-3200-204-100
150 Ft RJ45 CAT6 Cable	910-3200-204-150
200 Ft RJ45 CAT6 Cable	910-3200-204-200

**BMA CT**

## **ISOMETRIC DIAGRAMS**

**SIDE VIEWS**

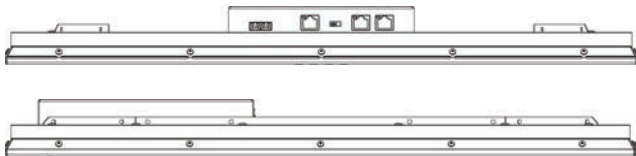

**BACK VIEW**

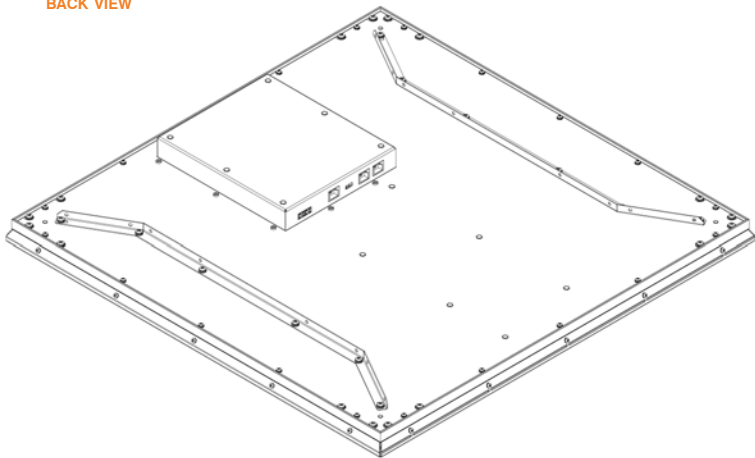



## Supported CONVERGE Pro 2

Item	Part No.
CONVERGE Pro 2 128	910-3200-001
CONVERGE Pro 2 128D	910-3200-001-D
CONVERGE Pro 2 128T	910-3200-002
CONVERGE Pro 2 128TD	910-3200-002-D
CONVERGE Pro 2 128V	910-3200-003
CONVERGE Pro 2 128VD	910-3200-003-D
CONVERGE Pro 2 128VT	910-3200-009
CONVERGE Pro 2 128VTD	910-3200-009-D
CONVERGE Pro 2 48T	910-3200-005
CONVERGE Pro 2 48V	910-3200-006
CONVERGE Pro 2 48VT	910-3200-008
CONVERGE Pro 2 48VTD	910-3200-008-D
CONVERGE Pro 2 120	910-3200-004

## CLEARONE LOCATIONS

### Headquarters:

5225 Wiley Post Way  
Suite 500  
Salt Lake City, UT 84116

**Tel:** 801.975.7200

**Sales:** 800.707.6994

### US & Canada

**Tel:** 801.975.7200

**Toll Free:** 800.945.7730

**Fax:** 801.303.5711

### International

**Tel:** +1.801.975.7200

**e-mail:** global@clearone.com

### Sales

**Tel:** 801.975.7200

**e-mail:** sales@clearone.com

### TechSupport

**Tel:** 801.974.3760

**e-mail:** tech.support@clearone.com