

EMOTIVA®



XMC-1

7.2 Channel AV Preamp Processor

Important Safety Precautions and Explanation of Symbols



The exclamation point within an equilateral triangle is intended to alert the user to the presence of important installation, operation, and service instructions in this manual.



The lightning flash with arrowhead symbol within an equilateral triangle is intended to alert the user to the presence of uninsulated dangerous voltages within the enclosure that may be of sufficient magnitude to constitute a risk of electrical shock to the user.

Please read this manual thoroughly before attempting to install, configure, or operate the Emotiva XMC-1. After successful installation and configuration of the XMC-1, be sure to retain this manual in a safe place for future reference.

Safety is a key component of a long lasting and trouble free installation. Please read and follow all instructions and heed all warnings on the XMC-1 and in this manual. The vast majority of the subsequent safety precautions are common sense. If you are not comfortable with the installation of audio/video entertainment equipment, you should seek the services of a qualified installation professional or call us for help.



WARNING: TO REDUCE THE RISK OF FIRE OR ELECTRIC SHOCK, DO NOT USE THE XMC-1 NEAR WATER OR IN WET LOCATIONS, DO NOT EXPOSE IT TO RAIN OR MOISTURE, DO NOT EXPOSE IT TO DRIPPING OR SPLASHING FROM OTHER SOURCES, AND ENSURE THAT NO OBJECTS FILLED WITH LIQUIDS (SUCH AS VASES) ARE PLACED ON IT. DOING SO MAY RESULT IN DAMAGE TO THE XMC-1 AND THE RISK OF ELECTRIC SHOCK, WHICH MAY RESULT IN BODILY INJURY OR DEATH.



WARNING: TO REDUCE THE RISK OF ELECTRIC SHOCK, DO NOT REMOVE THE COVER FROM THE XMC-1. THERE ARE NO USER-SERVICEABLE PARTS INSIDE THE XMC-1. REFER ALL SERVICE TO QUALIFIED SERVICE PERSONNEL.

Do not install the XMC-1 near or above any heat sources such as radiators, heating vents, or other apparatus that produce heat. Do not block any ventilation openings or heat sinks. Avoid installing the XMC-1 directly above other heat-producing equipment unless sufficient ventilation or forced-air cooling is provided.

Do not install the XMC-1 in locations without proper ventilation. The XMC-1 should not be operated on a bed, sofa, rug, or similar surface that may block vents. The XMC-1 should not be installed in an enclosed location such as a bookcase, cabinet, or closed equipment rack unless sufficient forced-air ventilation is provided.

Always install your XMC-1 according to the manufacturer's instructions and only use attachments or accessories specified by the manufacturer.

Do not install the XMC-1 on any stand, shelf, or other piece of furniture that is unable to support its weight. If a cart is used to move the XMC-1, use caution to avoid injury from tip-over.

Connect the XMC-1 only to power sources of the correct voltage (as shown in this manual and on the XMC-1).

Protect power supply cables from being pinched, walked on, or otherwise damaged. Be especially careful where the power cable enters the power outlet and the XMC-1 unit.

Only connect the XMC-1 to an electrical outlet or extension cord of appropriate type and rating.

DO NOT defeat the safety purpose of a grounding or polarized plug by removing ground pins or using unsafe adapters. A polarized plug has two blades - one wider than the other. A grounding plug has a third ground prong in addition to the two main conductors. The wide blade or third grounding prong is provided for your safety. If the provided plug does not fit your outlet, consult an electrician to replace your obsolete outlet. If you replace the power cord on the XMC-1, only use one of similar type and equal or greater current rating.

The power cable for the XMC-1 should be unplugged from the outlet during severe electrical storms, or when unused for a long period of time.

Only replace the fuses in the XMC-1 with fuses of proper value and voltage rating.

The XMC-1 should only be cleaned as directed in the manual. Avoid spraying liquids directly onto the XMC-1 and NEVER spray liquids into the vents. Care should be taken so that small objects do not fall into the inside of the XMC-1.



You should seek service for your XMC-1 by qualified service personnel if any of the following occur:

1. The power-supply cord or the plug has been damaged.
2. Objects or liquid have fallen or spilled into the vents.
3. The XMC-1 has been exposed to rain.
4. The XMC-1 exhibits a marked change in performance.
5. The XMC-1 has been dropped, or its enclosure or chassis is damaged.

NOTE: TO COMPLETELY DISCONNECT THE XMC-1 FROM THE AC POWER MAINS, DISCONNECT THE AC POWER CORD FROM THE AC RECEPTACLE.

NOTE: THE XMC-1 AC POWER CORD MUST REMAIN READILY ACCESSIBLE AT ALL TIMES.

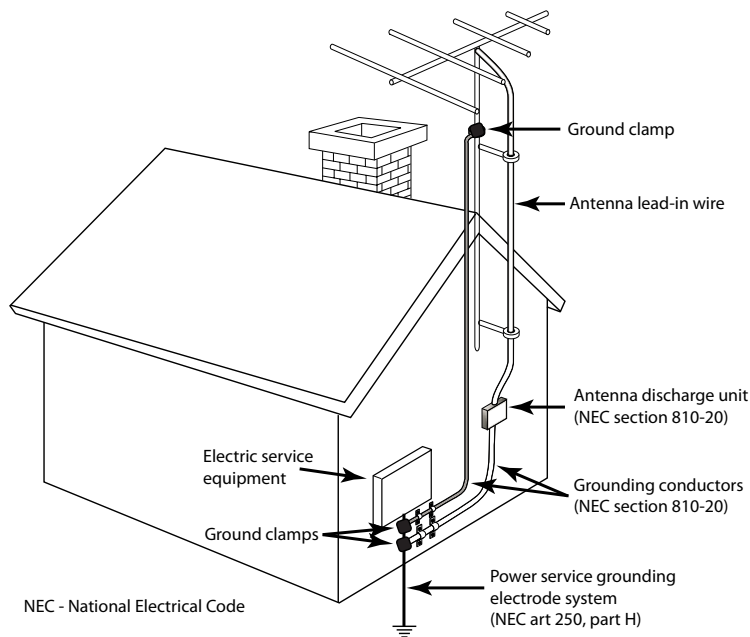
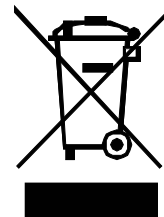

FCC Interference Statement

Note: This equipment has been tested and found to comply with the limits for a Class B digital device, pursuant to Part 15 of the FCC rules. These limits are designed to provide reasonable protection against harmful interference in a residential installation. This equipment generates, uses and can radiate radio frequency energy and, if not installed and used in accordance with the instructions, may cause harmful interference to radio communications. However, there is no guarantee that the interference will not occur in a particular installation. If this equipment does cause harmful interference to radio or television reception, which can be determined by turning the equipment off and on, the user is encouraged to try to correct the interference by one or more of the following measures:

Reorient or relocate the receiving antenna.

Increase the separation between the equipment and receiver.

Connect the equipment to an outlet on a circuit different from that of the receiver.

Consult the manufacturer or an experienced radio/TV technician for help.

For questions regarding service, please contact:

Emotiva Audio Corporation
Attn: Repair Department
139 Southeast Parkway Court
Franklin, TN 37064

1-877-366-8324
www.emotiva.com

Emotiva XMC-1

7.2 Channel AV
Preamp/Processor

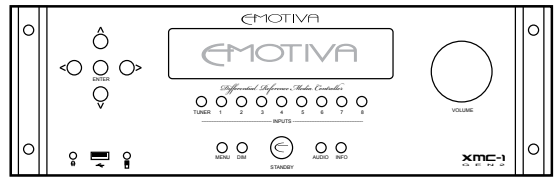

Contents

Important Safety Precautions and Explanation of Symbols	
FCC Interference Statement	
Introduction	2
About This Manual.....	3
Unpacking.....	4
Welcome to the XMC-1	5
Specifications.....	8
Operating the XMC-1	12
The XMC-1 Menu System	27
Connecting the XMC-1	63
Care and Maintenance	85
Troubleshooting	93
Appendices.....	96
Emotiva Audio Corporation Limited Warranty	100
Notes.....	103

Introduction

Introduction

Thank you for choosing the new Emotiva XMC-1 7.2 Channel AV Preamp/Processor. The XMC-1 is the culmination of years of research and design, and truly represents the current state-of-the-art in surround sound processors.

The XMC-1 is based on an all new, custom designed hardware platform that delivers cutting edge video performance and true audiophile calibre sound quality. Powerful DSP processors decode the latest surround sound formats; high-quality DACs deliver superb quality audio to a highly optimized balanced analog signal path; and interstage hardware-based ASRCs (asynchronous sample rate converters) ensure immunity from the jitter that plagues other processors. Our elegant control system is sophisticated, yet user friendly, and allows full control of the XMC-1 from the front panel, the included all-metal remote, or by a remote control application on your computer or smart phone. Firmware updates are also easy; and run from a simple USB stick.

While some pre/pros give you a simplified automatic room correction system, or a manual equalizer, the XMC-1 offers a full set of powerful controls that let you get the absolute best from your room and speakers. Dirac Live™ provides the best automatic room correction available today; powerful parametric equalizers are available for audiophiles who prefer to manually dial-in their own corrections; the XMC-1 can import filter settings directly from Room Equalization Wizard; and, for those who prefer them, we've included real tone controls - with variable bass and treble turnover frequencies. The tone controls allow you to fine tune how your system sounds, even if you're already using another room correction method.

The XMC-1 also includes a full palette of video features including 8 HDMI 1.4b inputs and 2 HDMI outputs - with fast, powerful, glitch free video switching and full support for 4k / 60 Hz and 3D. The XMC-1's advanced Video on Standby feature not only lets you watch video directly when the XMC-1 is in Standby mode; you can even change video inputs from Standby mode; and the concise, easy to read, on-screen menu system displays over live video - even 3D video.

Enjoy.

The Emotiva Team

About This Manual

About This Manual

This manual will provide you with all the information you need to install and configure the XMC-1 to achieve its optimum potential.

You may wish to record serial numbers or other purchase information on the Notes page at the back of this manual.

Unpacking

Unpacking

Your XMC-1 was carefully packed and should reach you in perfect condition. If you notice any shipping damage or other issues when you unpack it, please contact Emotiva immediately.

Gently remove your XMC-1 from the packing carton and remove all wrappings and shipping material.

It is important to save the box and all packing materials in case your processor ever needs to be moved or shipped back to the factory for service.

We truly value customer feedback and would like to hear from you.

What's In The Box

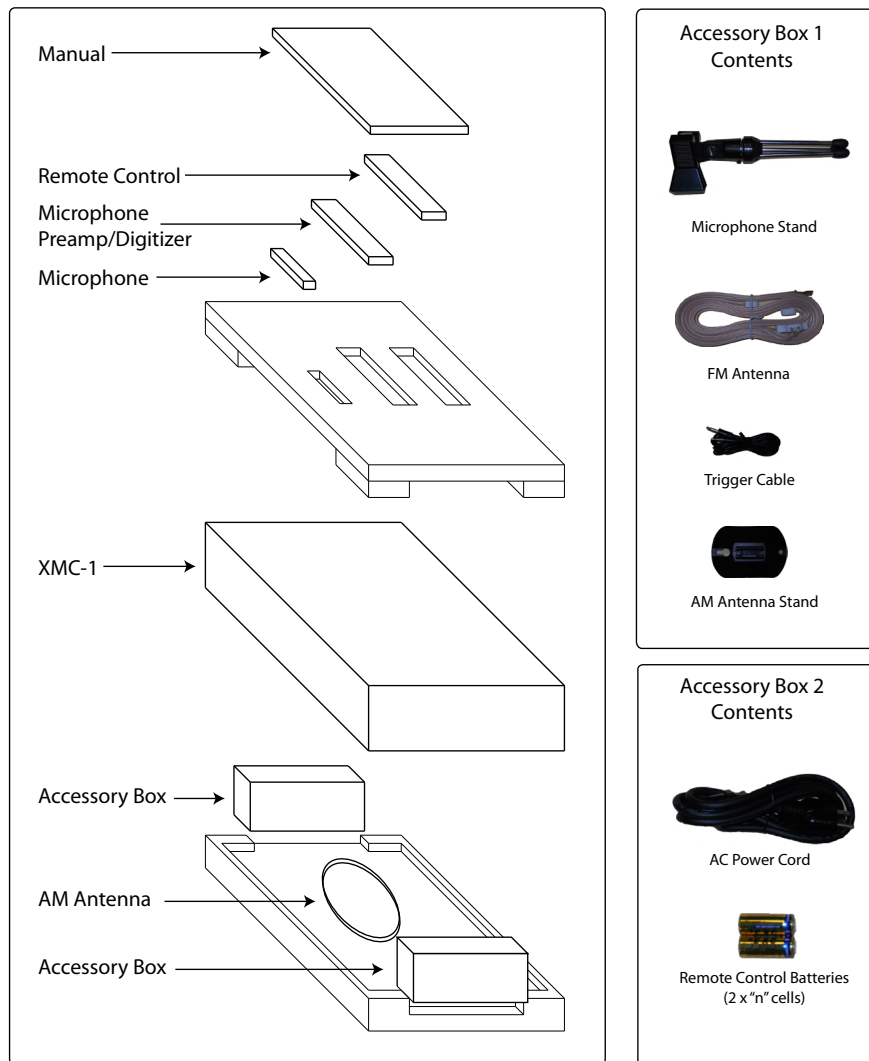

Welcome to the XMC-1

Welcome to the XMC-1

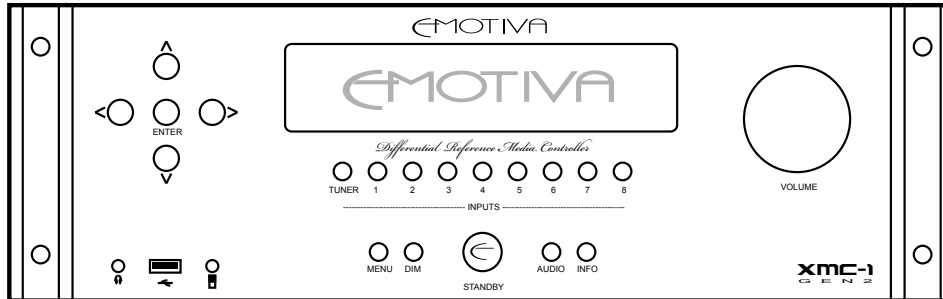

The Emotiva XMC-1 combines cutting edge features and flexibility, true audiophile sound quality, superior video switching capabilities, and a comprehensive, yet easy to use menu and control system - in a single A/V preamp/processor that will truly redefine everything you know about home theater. Even better, the XMC-1 is designed and manufactured by Emotiva in the United States of America...

Audiophile Sound Quality

The XMC-1 combines the latest audio processing modes and features with true audiophile sound quality. The XMC-1's Differential Reference mode delivers true balanced two channel audio performance rivalling that of the finest analog preamps available today. From analog and digital inputs to fully balanced outputs, the XMC-1 has a true audiophile quality signal path, which includes high quality digital-to-analog converters (DACs), hardware asynchronous sample rate converters (ASRCs), and a precision resistor analog ladder network volume control.

Flexible Audio Processing Modes

The XMC-1 offers the ultimate combination of advanced surround sound processing modes and purist audiophile options. In addition to the latest high-resolution surround-sound modes, Reference Stereo Mode provides absolutely pure audiophile sound with no processing whatsoever, and our refined Direct Mode includes minimal processing options, but still offers bass management.

Welcome to the XMC-1

Dirac Live Automatic Room Correction System

The XMC-1 features Dirac Live™, the most advanced automatic room correction system available for both audiophile and home theater systems. Dirac Live performs a series of measurements, then uses sophisticated mathematics to calculate a set of filters which correct both the frequency and time domain response of your room and speakers. The result is crystal clear, accurate sound reproduction, with a cohesive sound stage and excellent rendition of transients - even in less than ideal rooms.

Powerful Manual Room Correction

For those who prefer to do their own room adjustments, the XMC-1 provides powerful manual parametric equalization controls. The XMC-1 allows you to create two entirely independent EQ presets; each preset includes 11 fully adjustable bands of parametric equalization for each speaker. For each input, you get to decide whether to use the automatic room correction provided by Dirac Live or one of your two user-defined presets.

Integration With Room EQ Wizard (REW)

Room EQ Wizard is a very popular free software program that allows you to perform many different measurements on your audio system, analyze the results, produce a wide variety of reports and graphs, and calculate correction parameters for use with a parametric equalizer. Correction filter settings generated by REW can now be imported directly into the XMC-1, and filter settings from the XMC-1 can be exported directly to REW. Parametric equalizer filter settings are imported and exported using a standard XML file format, which allows the settings to be edited externally and then re-imported, or stored for later analysis and use.

Convenient Tone Controls

In addition to manual parametric equalizers, the XMC-1 also includes true Tone Controls. Both Bass and Treble Controls include fully configurable turnover points, and the Tone Controls are available both as temporary adjustments (Tone Trims) and as persistent controls (which remain set until changed). The Tone Controls and Tone Trims operate independently of each other, and both can be used in conjunction with either Dirac Live or the Manual EQ Presets enabled.

True DSD Playback

The XMC-1 offers audiophile quality playback of DSD audio (when received via HDMI from an SACD or a DSD audio file), which bypasses all processing for the most accurate audio rendition possible.

Welcome to the XMC-1

Popular Remote Control Options

The XMC-1 offers a wide range of remote control options, including a solid metal infrared (IR) remote control, network-based remote control, and remote control apps for a variety of portable devices (starting with iDevices, Android devices, and Windows computers). Remote control codes will be provided for programming intelligent IR remote controls and for developing network-based remote control applications.

Advanced Video On Standby

The XMC-1 incorporates an advanced feature which not only allows you to watch - or continue to watch - video on your monitor while the XMC-1 is in Standby Mode, but even allows you to change sources while in Standby. This feature is great if you just want to do a quick check of the weather, or let the kids watch TV without turning on your main system.

Multiple Zones

The XMC-1 offers an independent second audio zone, which can deliver a stereo version of the same content that is selected in the Main Zone, or can be configured to play audio from a different source (either digital or analog).

Specifications

Specifications

Analog Performance

Balanced Input to Balanced Output (Reference Stereo Mode)

THD: <0.0005% @ 1 kHz
THD: < 0.002% (20 Hz to 20 kHz)
IMD: < 0.004% @ 1 kHz
S/N ratio: > 123 dB (A weighted)
Frequency Response: 5 Hz to 80 kHz (+0 / -0.1 dB)
Crosstalk: <100 dB

Unbalanced Input to Unbalanced Output (Reference Stereo Mode)

THD: <0.0007% @ 1 kHz
THD: < 0.003% (20 Hz to 20 kHz)
IMD: < 0.005% @ 1 kHz
S/N ratio: > 114 dB (A weighted)
Frequency Response: 5 Hz to 80 kHz (+0 / -0.1 dB)
Crosstalk: <100 dB

Digital Input to Balanced Analog Output (HDMI PCM)

THD: < 0.00025% @ 1 kHz
THD: < 0.002% (20 Hz to 20 kHz)
S/N ratio (all main channels): > 110 dB (A weighted)
S/N ratio (subwoofer channels) > 100 dB (A weighted)

Analog-to-Digital Converters

(Analog Input to Analog Output via digital signal path)

THD: <0.0007% @ 1 kHz
THD: < 0.0007% (20 Hz to 20 kHz)
IMD: < 0.005% @ 1 kHz
S/N ratio: > 106 dB (A weighted)

Specifications

Input Impedance (Analog)

Balanced Inputs: 47 kOhms

Unbalanced Inputs: 100 kOhms

Output Impedance (Analog)

Balanced Outputs: 100 Ohms

Unbalanced Outputs: 100 Ohms

Maximum Output Level (Analog)

Balanced Outputs: 11 VRMS

Unbalanced Outputs: 5.5 VRMS

Decoding and Processing Modes

Digital Decoding Modes

Dolby TrueHD

Dolby Digital Plus

Dolby Digital 5.1

DTS-HD Master Audio

DTS-HD High Resolution Audio

DTS 5.1

DTS ES Discrete 6.1

PCM-Multi 5.1

PCM-Multi 7.1

Digital Post Processing Modes

Dolby Prologic IIx (PLIIx)

DTS ES Matrix

Audio Operating Modes

Reference Stereo (purist stereo mode)

Direct Mode (minimal processing; with bass management)

Stereo Mode

All Stereo Mode ("party mode")

Display and OSD

Display

OLED (blue; high resolution 256 x 60 pixel graphical; variable brightness)

OSD

Color OSD is displayed over live video, including 4k and 3D sources

(variable transparency; multiple operating modes provide different levels of information)

Specifications

Inputs / Outputs

Analog Inputs

- 1 pair (stereo) – Reference quality analog audio (balanced XLR)
- 1 pair (stereo) – Reference quality analog audio (unbalanced; machined gold-plated RCA connectors)
- 3 pairs (stereo) – Analog audio (unbalanced)
- 1 set (7.1 channels) – Analog audio (unbalanced)

Digital Inputs

- 8 – HDMI 1.4b
- 3 – Toslink optical S/PDIF digital audio (up to 24/192)
- 3 – Coax (RCA) electrical S/PDIF digital audio (up to 24/192)
- 1 – AES/EBU (XLR) digital audio
- 2 – USB Type A digital data (for firmware updates and future enhancements)
- 1 – USB Type B digital audio (“USB DAC” input; up to 24/192, UAC2, using CM6631A)
- 1 – Ethernet port (RJ-45) (network connection for Dirac and remote control applications)

Other Inputs

- Internal high-performance AM/FM tuner (antenna connections: FM - “F” connector; AM - push terminals)

Analog Outputs

- 1 set (7.2 channels) – Reference quality main analog audio (balanced XLR)
- 1 set (7.2 channels) – Main analog audio (unbalanced; machined gold-plated RCA connectors)
- 1 pair (stereo) – analog line level record output (unbalanced)
- 1 pair (stereo) – analog line level main zone mix output (unbalanced)
- 1 pair (stereo) – analog line level Zone 2 output (unbalanced)
- 1 – high quality headphone output (using TPA-6130)

Digital Outputs

- 2 – HDMI 1.4b (Main output with CEC and ARC)
- 1 – Toslink optical S/PDIF digital audio
- 1 – Coax (RCA) electrical S/PDIF digital audio

Specifications

Power / Environmental

Power Consumption

Operation: 35 Watts (42 VA)

Standby: 0.5 Watts (2.4 VA)

Video On Standby: 30 Watts (37 VA)

Dimensions

Unboxed: 17" Wide x 15.5" Deep x 5.25" High (not counting feet)

Unboxed: 17" Wide x 15.5" Deep x 5.75" High (with feet)

Boxed: 22" Long x 19" Wide x 11" High

Weight

Unboxed: 21 pounds

Boxed: 30 pounds

Operating the XMC-1

Operating the XMC-1

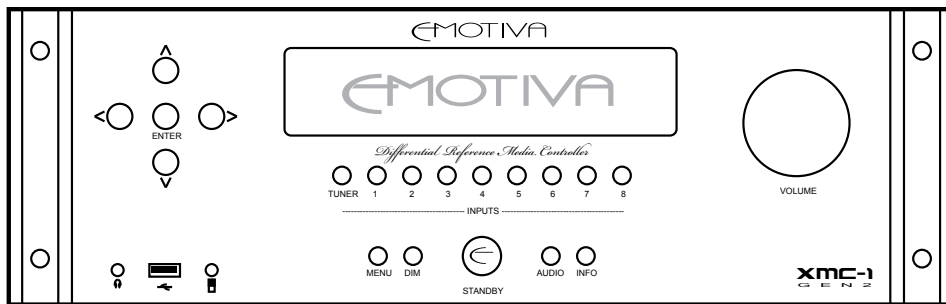

Audio Modes

Reference Stereo Mode

Reference Stereo Mode provides the purest listening experience, with the fewest options for processing or modifying the signal.

In Reference Stereo Mode:

- The output is always *TWO CHANNEL STEREO*.
- There is *NO* bass management, and *NOTHING* is sent to the subwoofer.
- You *CANNOT* use the Loudness Control, or the Tone Presets, or the Tone Trims.
- You *CANNOT* use Dirac Live or the manual Parametric EQ Presets.
- Level Trims, which operate in the analog domain, are still available.
- Speaker Distance adjustments are active for digital inputs but not for analog inputs.
- Stereo analog input signals are passed straight to the Volume Control and the outputs.
- Stereo digital input signals are converted to analog then sent to the Volume Control.
- Surround sound digital signals are decoded, mixed down to stereo (the Center Channel and LFE signals, if present, are mixed into the stereo output), and converted to analog.

Note: Because Reference Stereo Mode does not include bass management, care should be used when playing “small” speakers in this mode. Reference Stereo Mode CANNOT be selected using the “Mode Up/Down” buttons, but can be selected as the current mode in the Main Zone Configuration Menu, and can be configured as the default mode for an input.

Note: Reference Stereo Mode may also be accessed directly from the front panel controls by pressing the Audio button while pressing and HOLDING the Enter button.

Note: When using the Analog 7.1 Channel Inputs, the ONLY available mode is Analog Bypass, which passes the incoming analog channels directly to the output with no processing or bass management. In this mode, the LFE channel will be routed to both subs if you have two subs configured.

Note: In Reference Stereo Mode and Direct Mode, you cannot use PLIIx or any other post processing mode intended to “enhance” the audio signal. Decoding is limited to converting digital surround signals to analog using the highest quality, purest decoding method possible.

Direct Mode

Direct Mode provides a relatively pure listening experience, and eliminates most processing, but still retains bass management.

In Direct Mode:

- The output contains the same number of channels as the input signal.
- No extra channels are synthesized; if the output channel that corresponds to a given input channel is not present, that channel signal is mixed into the appropriate available channels.

Operating the XMC-1

- Bass management *IS* available and the subwoofer *IS* active.
- You *CANNOT* use the Loudness Control, or the Tone Presets, or the Tone Trims
- You *CANNOT* use Dirac Live or the manual Parametric EQ Presets.
- Level Trims, which operate in the analog domain, are still available.
- Speaker Distance adjustments are available for both analog and digital inputs.
- Stereo digital signals are presented directly to the processor.
- Stereo analog input signals are converted to digital and passed to the processor.
- Surround sound digital signals are decoded, and passed to the processor.
- Multi-channel discrete digital signals (like multi-PCM) are passed directly to the processor.
- All signals receive bass management - but no other processing.
- If an LFE signal is present, and one or two subwoofers are also present, the LFE content will be routed to the subs along with low-frequency content from the main channels (as determined by the bass management settings).

Stereo Mode

Stereo Mode provides a full complement of processing and control options - with a stereo output.

In Stereo Mode:

- The output is always *TWO CHANNEL STEREO*.
- Bass management *IS* available and the subwoofer *IS* active.
- Loudness Control, the Tone Controls, and the Tone Trims are active.
- Dirac Live and the manual Parametric EQ Presets are active.
- Level Trims are active.
- Speaker Distance adjustments are available for both analog and digital inputs.
- Stereo digital signals are presented directly to the processor.
- Stereo analog input signals are converted to digital and passed to the processor.
- Surround sound digital signals are decoded, down-mixed to stereo, and passed to the processor.
- Multi-channel discrete digital signals (like multi-PCM) are down-mixed to stereo and passed to the processor.
- If an LFE signal is present, and one or two subwoofers are also present, the LFE content will be routed to the subs along with low-frequency content from the main channels (as determined by the bass management settings).

All Stereo Mode

All Stereo Mode provides a full complement of processing and control options - with a stereo output. In addition, the left signal is routed to all left side speakers and the right signal is routed to all right side speakers for a "room filling" experience. In All Stereo Mode:

- The output is always *TWO CHANNEL STEREO* - *routed to all speakers*.
- The left channel is routed to all left side speakers; the right channel to all right side speakers; and the center channel speaker receives a mix of left and right.

Operating the XMC-1

- Bass management *IS* available and the subwoofer *IS* active.
- Loudness Control, the Tone Presets, and the Tone Trims are active.
- Dirac Live and the manual Parametric EQ Presets are active.
- Level Trims are active.
- Speaker Distance adjustments are available for both analog and digital inputs.
- Stereo analog signals are converted to digital audio and routed through the processor.
- Stereo digital input signals are routed through the processor.
- Surround sound digital signals are decoded, mixed down to stereo, and converted to analog (the Center Channel and LFE signals, if present, are mixed into the stereo output).
- After all processing is completed, the left signal is routed to ALL left side speakers and the right signal is routed to ALL right side speakers; and the center channel speaker receives a mix of left and right. .
- If an LFE signal is present, and one or two subwoofers are also present, the LFE content will be routed to the subs along with low-frequency content from the main channels (as determined by the bass management settings).

Discrete (Digital) Surround Sound Formats

Discrete Digital Surround Sound formats like Dolby TrueHD and DTS-HD Master Audio contain high-quality discrete multi-channel digital audio; each channel is stored separately, and the decoded audio is an exact replica of the original content.

For audio encoded in these formats, the XMC-1 will automatically detect the format and use the correct decoder.

Matrix Surround Sound Formats

Matrix Surround Sound processing modes like Dolby PLIIx and DTS Neo:6 use information in the audio signal itself to create additional audio channels from the channels already present. These processing modes can be used to recreate multi-channel audio from stereo content that was specifically encoded for them - although, unlike with discrete surround sound formats, the result will only be an approximation of the original. Originally, various Matrix Surround Sound formats were used to deliver surround sound content; today virtually all surround sound content is encoded in one of the discrete formats.

Today, these modes are most commonly used as post processing modes to synthesize extra channels, either to transform stereo music into 5.1 channel or 7.1 channel surround sound, or to transform discrete 5.1 channel surround sound into synthesized 7.1 channel surround sound.

The XMC-1 will offer you the option of choosing various Matrix Surround Sound Processing Modes where appropriate.

Operating the XMC-1

Note: Some Matrix Surround Sound processing modes are not appropriate to use with certain types of input signals, and some may conflict with certain other modes. For example, Dolby PLIIx may be used to transform stereo analog content into 5.1 channel or 7.1 channel surround sound content, and may be used to transform 5.1 channel Dolby Digital or Dolby TrueHD content into synthesized 7.1 channel content, but cannot be used with 7.1 channel Dolby TrueHD content (because it is already 7.1 channels). The XMC-1 will ONLY allow you the option of choosing modes that are appropriate for your current signal source and mode.

How the XMC-1 Treats Content in Different Surround Sound Formats

The combination of Surround Sound decoding and Surround Sound processing the XMC-1 uses for a given input signal will depend on the format of the incoming signal, and on how you have configured the Surround Mode in the Setup Inputs Menu and Main Zone Menu.

The Setup Inputs Menu allows you to configure the default behavior independently for each input for each type of input signal:

In *Auto Mode* - the XMC-1 will attempt to process the incoming signal to match the number of speakers you have configured. For example, if your XMC-1 is configured for 5.1 speakers, a Dolby TrueHD 5.1 channel input signal will be decoded to 5.1 channels, and a Dolby TrueHD 7.1 channel input signal will be decoded to 7.1 channels, then mixed down to 5.1 channels. If your XMC-1 is configured for 7.1 speakers, a Dolby TrueHD 5.1 channel input signal will be decoded to 5.1 channels, then the surround channels will be processed with Dolby PLIIx to create a 7.1 channel output optimized for your 7.1 channel system.

In *Last Used Mode* - the XMC-1 will use as it's default the same decoding and processing options as were used the last time a similar signal was received on that input. (If, the last time a Dolby TrueHD input was received on that input, you manually chose to listen in Stereo Mode, then Stereo Mode will be the default the next time a similar signal is received on that input.)

You will also have the option of manually configuring an initial default mode for each input - for each type of input signal which may be received. The specific options available will depend on the type of input.

Regardless of what decoding and post processing modes are selected automatically by the XMC-1, you will always be able to manually choose to use any combination of decoding and processing modes that are appropriate for the type of input signal being received - either by using the Mode Selector buttons on the front panel or remote control, or from the Main Zone Menu.

Note: Reference Stereo Mode must be configured from the menu system; it cannot be selected manually using the Mode Up/Down buttons.

Note: When the XMC-1 is configured for a single subwoofer, your subwoofer must be connected to the XMC-1's Left Subwoofer output. When the XMC-1 is configured for a single rear surround speaker, the same (monaural) surround signal is presented at both Rear Surround outputs.

Operating the XMC-1

The XMC-1 Start-Up Routine

The XMC-1 is controlled by a custom Linux-based operating system. Even though loading and initializing the operating system is a complex process, the start up sequence on the XMC-1 has been optimized to minimize the delays you will experience in normal operation.

The start up routine for the XMC-1 will progress differently depending on whether you have enabled the Video on Standby feature in the configuration menu.

Video On Standby

The XMC-1 has a feature which allows it to operate in a special Standby mode when you switch it into Standby. In this mode, all video and audio processing is disabled, but the XMC-1 will still pass audio and video directly to your TV or monitor, and the controls on the XMC-1 will still allow you to change sources. This feature may be used to allow your family to continue to watch TV on the TV monitor connected to the XMC-1 even when “the big stereo” is turned Off.

The Video on Standby feature is configured in the Setup | Advanced Menu (to use this mode, configure Standby in the XMC-1 for “Video Remains On”).

When the Video on Standby feature is NOT Enabled

When you turn on the rear panel Power switch, the XMC-1 will go into Standby Mode (the halo ring around the front panel Standby button will illuminate amber).

When you then press the front panel Standby button, the XMC-1 will load and initialize the operating system. During this time, the Emotiva logo will appear in the front panel display, and a progress bar will be shown along the bottom of the display.

When the XMC-1 is fully initialized, the display will change to the normal Information display.

Pressing the Standby button on the front panel or the remote control will return the XMC-1 to Standby Mode.

When the Video on Standby feature IS Enabled

When you turn on the rear panel Power switch, the XMC-1 will go into a special Standby Mode which allows the Video on Standby feature to operate even though the main power is off.

When you first turn on the rear panel switch, the halo ring around the front panel Standby switch will illuminate blue. The XMC-1 will then load and initialize the operating system, during which time the Emotiva logo will appear in the front panel display a progress bar will be shown along the bottom of the display.

When the XMC-1 is fully initialized, the display will switch off and the halo ring around the front panel Standby button will illuminate amber. At this point the XMC-1 is in a special Standby mode and the Video on Standby feature is operational.

Operating the XMC-1

Note: When the Video on Standby feature is enabled, pressing the Standby button (from On) places the XMC-1 in a special standby mode. The XMC-O/S remains loaded in this mode, and so doesn't have to be re-loaded when you turn the XMC-1 back On. Leaving the Video on Standby Mode enabled allows the XMC-1 to switch from Standby Mode to On very quickly. For this reason, you may prefer to have Video on Standby Mode enabled even if you don't watch video while the XMC-1 is in Standby Mode.

Bass Management

The XMC-1 is a full 7.2 channel surround sound processor, which means that it supports two independent stereo subwoofers.

If you have two subwoofers, and configure the XMC-1 for Stereo subs, then both subs will be configured separately, and will operate in full stereo mode. Both subs will receive content from the LFE (low frequency effects) channel and, in modes where bass management is active, the Left Subwoofer will receive audio content at frequencies below the configured crossover points for the Left Front, Left Surround, and Left Back Surround Speakers; the Right Subwoofer will receive audio content at frequencies below the configured crossover point for the Right Front, Right Surround, and Right Back Surround Speakers; both subwoofers will receive audio content below the crossover frequency for the Center Channel.

If you have two subwoofers, and configure the XMC-1 for Dual Mono subs, then both subs will be configured separately, but both will receive the same summed mono signal. Both will receive content from the LFE (low frequency effects) channel and, in modes where bass management is active, will also receive audio content at frequencies below the configured crossover points for your Front, Surround, Back Surround, and Center Speakers.

If you have one subwoofer, and configure the XMC-1 for a Mono sub, then that sub will receive content from the LFE channel and, in modes where bass management is active, it will also receive audio content at frequencies below the configured crossover points for all your other channels. In this configuration, your one sub should be connected to the XMC-1's Left Subwoofer output.

Note: Because some "localization" of subwoofer content may occur in some situations, stereo subs should ideally be identical, and should be positioned symmetrically in the listening room. If you have two very dissimilar subwoofers, or plan to place two or more subs in positions that are NOT symmetrical - perhaps for purposes of evening out response variations caused by major room modes, you may get better performance by configuring the XMC-1 to use Dual Mono subs. Using asymmetrically placed stereo subwoofers, or dissimilar stereo subs, may result in imperfect imaging and a sound stage that is less than optimal. This will depend on the specifics of your subwoofers, your listening room, and your configuration.

Operating the XMC-1

Enhanced Bass

Enhanced Bass is a feature which allows you to combine the bass output of your subwoofers with the bass output of your large main speakers.

When Enhanced Bass is **disabled** (normal operation), bass from the LFE channel is routed to your subwoofer (or subs), bass below the crossover frequency of any speaker you have configured as small is also routed to your sub or subs, and bass from any channels you have configured as large is routed to the intended main speaker.

When Enhanced Bass is **enabled** on the XMC-1, bass from the LFE channel is routed to your subwoofer (or subs), bass below the crossover frequency of any speaker you have configured as small is also routed to your sub or subs, and bass from any channels you have configured as large is routed to the intended main speaker. **IN ADDITION**, bass below 80 Hz from the LFE channel is also routed to every speaker you have configured as large (except the center channel), and bass below 80 Hz **from all main speakers configured as large (including the center channel)** is also routed to your sub or subs.

Note: Enhanced Bass is designed to boost the overall amount of bass available. Music is rendered more accurately when Enhanced Bass is DISABLED. Also, since there is no industry standard, Enhanced Bass may be implemented differently on devices other than the XMC-1.

Tone Presets and Tone Trims

In addition to Dirac Live, and the parametric equalizer Preset options, the XMC-1 offers Tone Controls for making broad adjustments to large segments of the frequency band. Bass and Treble Tone Controls have independently configurable turnover points, and operate just like traditional “Bass and Treble” knobs or sliders.

The Tone Presets accessed via the Setup | Speakers | Presets | {preset} | Equalization | System EQ Menu are retained when the XMC-1 is powered Off. The Tone Trims accessed via the Main Zone | Trims | Tone Menu are temporary trims, and are not retained when the XMC-1 is turned Off.

Note: The Tone Presets and Tone Trims on the XMC-1 operate independently, and in addition to the Parametric EQs and Level Trims. (You can use them all at the same time and the effects will add together.)

Note: The XMC-1 utilizes automatic normalization routines to ensure that, no matter what combination of settings you make in the various Tone Presets, Tone Trims, and Level Controls, the XMC-1 will NOT digitally clip the audio signal. Therefore, no combination of settings made in the Level Trims, Tone Presets, or Tone Trims should result in clipping.

Note: Even though the normalization routines in the XMC-1 will prevent clipping under normal circumstances, it is POSSIBLE, by applying positive gain to multiple overlapping bands in the Parametric Equalizers in the XMC-1, to create a situation that will cause the XMC-1 to clip.

WE STRONGLY RECOMMEND THAT YOU AVOID APPLYING POSITIVE GAIN TO MULTIPLE OVERLAPPING PEQ BANDS. If you do so, please check carefully for clipping, and reduce the settings on those bands if any clipping occurs. (If clipping does occur due to band overlap, you must reduce the gain in one of the bands; you CANNOT eliminate it using the Level Trims.)

Operating the XMC-1

Headphone Output

The XMC-1 includes a high-quality front panel Headphone Output; the Main Outputs on the XMC-1 are muted when headphones are plugged into this output. When headphones are connected, all internal EQ processing is disabled (Dirac Live and the Speaker Presets are disabled while the headphones are connected.)

The XMC-1 also includes a unique level of intelligence in how it handles Level Trims and Tone Trims for the headphones; both sets of trims are configured and stored independently for the Main Outputs and the Headphone Outputs. When no headphones are connected, the Tone Trim and Level Trim settings you make apply to the Main Outputs; when headphones are connected, the Tone Trim and Level Trim settings apply to the headphones. When you unplug your headphones, the trim settings return to their previous settings for the Main Outputs; when you plug your headphones back in, they return to the previous settings for the headphones.

Note: Trim settings for BOTH the Headphone Output and Main Outputs are not persistent, and both are reset when you switch the XMC-1 into Standby Mode or switch it Off.

Playing SACD Audio in Pure DSD

There are a wide variety of disc players which support playback of standard SACD discs (and the SACD portion of hybrid discs). These discs are recorded in a special digital audio format called DSD (direct stream digital).

For audio purists who prefer to play the DSD content from SACD discs directly, without modification or processing, the XMC-1 supports direct playback of DSD audio content received over an HDMI connection. In order to utilize this feature, your player must be configured to deliver the unaltered DSD "bitstream" to the XMC-1 via HDMI.

Note: Different players require different settings to enable them to output DSD digital audio without converting it; and some players may not offer this option. On some players, you will select "DSD" as your output mode; on some you may select "bitstream" as your output mode when playing SACDs; and on others you will DISABLE the option "convert SACD output to PCM"; some players may require you to set multiple options on different menu pages.

Note: Many SACDs include versions of the same content in both Stereo and Surround Sound. These are actually separate tracks on the disc, and you must choose the one you want when playing the disc.

Note: Some players can also play DSD audio directly from a DXD or DSDIFF digital audio file. As long as the result is output to the XMC-1 as standard DSD via HDMI it should play as DSD.

The XMC-1 can play the standard DSD format which is used by SACD discs; it cannot play audio in the "DSDx2" or "DSD128" format, which is twice the standard SACD sample rate, or any other non-standard DSD sample rates.

Operating the XMC-1

Because DSD digital audio cannot be processed in the normal way, and because most purists who choose to listen to unconverted DSD content prefer to avoid any and all conversions and processing, the playback options for DSD content on the XMC-1 are limited. Two channel DSD content may be played in modes equivalent to Stereo and All Stereo, with no bass management or other processing. Surround Sound DSD content may be played in its original 5.1 channels, or the XMC-1 can be configured to duplicate the Surround Channels into the Rear Surround Channels (if you have a 7.1 or 7.2 system), also with no bass management or other processing.

If your player only supports converting DSD content to PCM, then the XMC-1 will treat it as it would any other PCM digital audio input. If you require bass management, or any other features not available with a DSD signal input, then you should configure your player to send its output to the XMC-1 in PCM format when playing SACDs.

Note: To play digital audio from an SACD, you MUST use an HDMI connection. The copy protection present on all SACD discs (including the SACD layer of hybrid discs) restricts the formats in which players are legally allowed to provide an audio output when playing them. When playing an SACD disc, players are allowed to provide analog audio (if they have analog outputs), and they are allowed to provide a digital audio output over an HDMI connection. They are NOT allowed to provide digital audio from other standard types of digital audio outputs (like Coax S/PDIF or Toslink). When playing an SACD disc, the player will mute all digital outputs OTHER THAN HDMI.

(If you connect only the Coax digital output of your universal disc player to the appropriate input on your XMC-1, you will be able to use that connection to play CDs, and to play the CD layer on hybrid SACDs, but you will get silence if you attempt to play an SACD, or the SACD layer of a hybrid disc, through that output. Some players may provide a lower quality digital audio output from their non-HDMI outputs, and some players will play a few seconds of music from those outputs before the copy protection mutes them, but the only output you can use to play full quality digital audio from an SACD disc is HDMI.)

Using the XMC-1 Tuner

The XMC-1 includes a high-quality AM/FM tuner, which can play all standard content from terrestrial radio stations. The XMC-1's tuner plays standard FM broadcasts (but not "digital" or "HD" radio broadcasts).

The XMC-1's display will show station or program identification information that is received via the RBDS data system used by many FM stations.

Note: The Name field, which can be configured for each station that is entered as a preset, is manually entered by the user, and is NOT derived from the RBDS information.

Operating the XMC-1's Tuner is slightly different depending on whether you're using the front panel controls or the remote control.

From the front panel: Pressing the Tuner direct input button will select the Tuner as the active input. To choose or configure a station, or set other Tuner parameters, use the Menu button to bring up the Menu, use the up and down arrows to move to the Tuner Menu, and then use the up, down, left, and right buttons to choose a station or enter other information.

Operating the XMC-1

Note: There are several shortcuts that can be used when operating the XMC-1 Tuner from the front panel. These Tuner shortcuts are accessed by pressing and holding the Tuner Input button on the front panel while operating additional controls:

To tune stations, turn the Volume knob WHILE PRESSING AND HOLDING THE TUNER BUTTON.

To skip to the last/next station, use the Up and Down navigation buttons WHILE PRESSING AND HOLDING THE TUNER BUTTON.

To seek to the last/next station, use the Left and Right navigation buttons WHILE PRESSING AND HOLDING THE TUNER BUTTON.

To switch between the AM and FM bands, press the Enter button WHILE PRESSING AND HOLDING THE TUNER BUTTON.

From the remote control: Pressing the Tuner direct input button will select the Tuner as the active input. Once the Tuner is your selected Input, you can use the direct control buttons on the remote control to move between stations or radio bands.

The AM/FM Button can be used to switch between the AM and FM radio bands.

The Station Up and Station Down buttons can be used to move directly to the next/last configured station preset.

The Seek Up and Seek Down buttons can be used to instruct the XMC-1 to seek in the chosen direction for the next available station with sufficient signal strength to provide acceptable listening quality.

The Tune Up and Tune Down buttons can be used to instruct the XMC-1 to move up or down to the next station frequency increment.

Note: The Tune buttons allow you to “manually” shift the frequency up or down to the next valid location for a station - whether any station is currently broadcasting at that frequency with sufficient strength for the XMC-1 to tune it or not. This is equivalent to manually turning a tuning dial, and can be used to configure preset stations that are too weak for the XMC-1 to detect automatically, or to configure preset stations that are not currently on the air.

Of course, if you prefer, you can operate the XMC-1's Tuner from the remote control using the Tuner Menu.

Operating the XMC-1

Dirac Live

Dirac Live takes the correction process a step further than other, more basic room correction systems. Because Dirac Live uses mixed-phase filters, it is able to calculate filters that not only correct the frequency response, but also compensate for errors in time response. This allows Dirac Live to correct more of the differences between how your speakers perform in your room, and how ideal speakers, in an ideal room, would sound - and enables Dirac Live to correct both frequency response and transient response. In simplest terms, because Dirac Live is not limited to correcting only problems related to frequency response, it does a better job of making your room sound more like it theoretically should.

In addition to its extensive set of manual adjustment and calibration tools, the XMC-1 includes Dirac Live for Emotiva™ - a powerful version of Dirac Live Room Correction optimized to run on the XMC-1 hardware platform.

Dirac Live is comprised of two modules: the Dirac Live Calibration Tool (DLCT), which takes the measurements, analyzes them, and calculates the correction filters, and the audio processing module that applies the correction filters to your music. Every XMC-1 purchase includes a license for a single-user copy of Dirac Live LE for Emotiva, which provides all the powerful room correction capabilities of Dirac Live, but offers limited options for user customization. Users who require the ability to further customize Dirac's operation and target curves will have the option of purchasing Dirac Live Full for Emotiva for a small additional charge. Both Emotiva versions of Dirac Live use the same custom programmed audio processing module, which runs on the DSP hardware in the XMC-1, and is included as a module in the XMC-1 firmware.

The Dirac Live Calibration Tool is a computer program which can be installed and run on any relatively current personal computer. Once the Dirac Live correction filters have been transferred to your XMC-1, they are accessed by simply selecting the Dirac Speaker Preset - which, like the two other Speaker Presets, can be selected manually from the Setup Menu or the remote control, or associated with specific inputs in the Setup Menu.

The Dirac Live LE for Emotiva™ package that comes with your XMC-1 includes the following:

- A single user license for the Dirac Live LE for Emotiva (DLCT) computer software.
- The Dirac Live audio processing module - which is part of the XMC-1 firmware.
- A calibrated test microphone designed specifically to work with Dirac Live for Emotiva.
- A precision USB microphone preamplifier and digitizer module - which enables you to connect the calibrated microphone directly to a USB port on your computer.
- A desktop microphone stand.

The Dirac Live Full for Emotiva™ upgrade package includes:

- A single user license for the Dirac Live Full for Emotiva (DLCT) computer software.

See the Dirac Live Addendum for detailed instructions about how to install, configure, and use Dirac Live for Emotiva Automatic Room Correction.

Operating the XMC-1

Manual Room Correction

The XMC-1 offers two separate Manual Room Correction Presets; each Preset can be labelled with a user-defined name; and each includes 11 bands of independent Parametric EQ for each speaker/channel, and Tone Presets (which are applied to all speakers). Each Input on the XMC-1 can be configured to use either of the two Presets, or the results of the Dirac Live Automatic Room Correction.

The parametric equalizers (parametric EQ or PEQ for short) offer 11 independently adjustable frequency bands for each channel/speaker. The center frequency, the width of the band, and the gain or cut, can be independently adjusted for each of those bands. The center frequency for each band is specified in Hz; the width of each band is specified in both Q and in Hz; and the gain is specified in dB. A band with a Q of 1.4 is approximately equivalent to a band in an old-style graphic equalizer; a higher Q value corresponds to a narrower band.

Note: You may adjust the width of each PEQ band by changing either the Q or the width in Hz. Because of the way the XMC-1 updates the display, only the value you are working with will change in real time on the display; the other value will change to match when you exit the field you are adjusting.

There are many different ways in which you can determine the proper values required to calibrate your system and your room using a parametric equalizer. A wide variety of textbooks are available on the subject of room equalization for those who are interested. Some audiophiles prefer to take manual measurements using a sound pressure level (SPL) meter or real-time audio analyzer (RTA). For them the XMC-1 includes sophisticated calibration tools, including a pink noise generator and a highly configurable sine wave generator. Some audiophiles prefer various software solutions; one very popular and incredibly flexible software room calibration tool is Room Equalization Wizard (REW). Some basic tools, including a simple SPL meter, only provide the information you need to manually determine what corrections to make; others, like REW, can provide you with specific values to enter into each PEQ filter on the XMC-1 to achieve a specific result.

The configuration controls for the Parametric EQ on the XMC-1 have been optimized to make this process as simple and efficient as possible - and to minimize the number of buttons you have to press to get the job done:

- You may, of course, adjust all of the filter bands for one speaker, then move on to the next speaker. However, if you prefer to adjust a specific band for all speakers, then move on to adjust the next band for all speakers, the XMC-1 facilitates this by remaining set to the particular EQ band number you're working on when you switch between speakers. For example, if you're adjusting Filter 3 for your Front Right speaker, and you then switch to the Front Left speaker, you will be taken directly to the settings for Filter 3 for the Front Left speaker; this way you can very easily adjust each Filter band sequentially for all your speakers.
- Test Tone Level and Test Tone Frequency settings are global; even though the controls for the Test Tone Generator appear on several different menu screens, there is only a single Test Tone Generator which you are accessing from different places. Therefore, as you move from place to place in the menu system where the Test Tone Generator is used, the Test Tone Generator will remain set at the last Level and Frequency you select until you change it. When you exit the area of the menu where the Test Tone Generator is used, it will automatically switch Off.

Operating the XMC-1

Configuring Triggers

The XMC-1 has four fully independent triggers, each one of which may be configured to activate an associated piece of trigger-enabled equipment when specific conditions are met. For example, you could use the triggers to activate the amplifiers that power your main front speakers whenever you play music, and the amplifier that powers your surrounds, and your powered subwoofer, only when you're listening to a surround sound source.

The triggers on the XMC-1 are configured by checking various boxes in the Setup Triggers Menu.

First, each trigger must be configured to be active when the Main Zone, Zone 2, or both zones are On. The trigger will *only* be active when one or more of the zones it is associated with are active.

Next, each trigger must be configured be associated with one or more Inputs. The trigger will *only* be active when one or more of the Inputs it is associated with are active.

For triggers associated with Zone 2, the trigger will be active whenever Zone 2 is On *AND* one of the Inputs associated with that trigger is selected.

For triggers associated with the Main Zone, there is an additional condition that must be met. For the Main Zone, each trigger must also be associated with one or more Speaker groups. The trigger will be active whenever the Main Zone is On, *AND* one or more of the Inputs associated with that trigger is active, *AND* one or more of the Speaker groups associated with that trigger is active.

Note: The triggers respond based on how the XMC-1 is configured; the XMC-1 does not detect the presence or absence of an active audio signal on specific channels.

Note: The option to configure associated Speaker groups only pertains to the Main Zone. Therefore, if you only have Zone 2 checked for a particular trigger, the Speakers column will not be displayed. However, if you have both Zone 2 and the Main Zone checked for that trigger, the Speakers column will be displayed; but please remember that the settings in that column *ONLY* pertain to the Main Zone and don't affect the status of Zone 2 triggering.

Note: All of the XMC-1's trigger logic is based on how the XMC-1 is currently configured. Whether your XMC-1 will send audio to the Surrounds will depend on which Input you have selected, the Mode you have configured that Input to use, the configuration of the Preset you have associated with that Input - including whether Surrounds are set to None in that Preset, and the source signal itself. If all these conditions are met, such that the XMC-1 is delivering audio content to the Surrounds, then any triggers associated with Surrounds will be active if their other requirements have also been met.

By default, the four triggers on the XMC-1 are configured as follows:

- Trigger 1: Main Zone (only), *ALL* Inputs, *ALL* Speakers
- Trigger 2: Zone 2 (only), *ALL* Inputs
- Trigger 3: Main Zone *AND* Zone 2, *ALL* Inputs, *ALL* Speakers
- Trigger 4: Main Zone *AND* Zone 2, *ALL* Inputs, *ALL* Speakers

Operating the XMC-1

Note: *In many situations, there are multiple ways of configuring the triggers on the XMC-1 to produce a certain result. Also, once a sufficient combination of conditions is met to cause a given trigger to be active, additional redundant conditions will be ignored. For example, if you configure a trigger to be active when a certain input and Surrounds are active, it will be active when that input and a surround sound mode are selected. Configuring that same trigger to also be active when that same input and Fronts are active would be redundant - because the Fronts are always active when the Surrounds are active - but the extra condition won't affect the end result.*

Headphone

Since triggers are most often used to switch amplifiers On and Off, the triggers on the XMC-1 are normally configured to be disabled when a pair of headphones is plugged into the *front panel headphone jack*. If you uncheck the Headphone Override box for a particular trigger, this override will be disabled.

Note: *The Headphone Override option is useful if you are using one of the XMC-1's triggers to activate your monitor, and you sometimes watch TV wearing headphones; if you uncheck the Headphone Override for that trigger, that trigger will remain active (assuming the other configured conditions are met), even when headphones are plugged in.*

Note: *The XMC-1 detects when headphones are connected by sensing a plug physically inserted into the front panel Headphone jack. If you leave a headphone extension cable plugged into the jack - but with no headphones connected, the XMC-1 will act as if headphones are connected. Also note that, if you use a separate headphone amplifier connected to one of the XMC-1's line level outputs, the XMC-1 will be unaware that you're using headphones.*

As an example of how the Triggers work on the XMC-1, let's assume you have a stereo amplifier which you use to power your Front Left and Front Right speakers, and a five-channel amplifier that you use to power your Surrounds, Backs, and Center speakers. You want both amplifiers to be On when you listen to surround sound movies, but only the Fronts and your stereo amp to be on when you listen to stereo CDs. For this example, we'll assume that you only use the Main Zone.

One way to achieve this result would be to connect your two channel amplifier to Trigger 1, and your five-channel amp to Trigger 3.

You would configure Trigger 1 to be activated *ONLY* by the Main Zone, but leave all the Input boxes checked, and leave all the Speaker boxes checked. This would configure your two-channel amp to be On whenever the Main Zone was on.

You would then configure Trigger 3 to be activated *ONLY* by the Main Zone, leave all the Input boxes checked, but uncheck all Speaker association boxes *EXCEPT* the box for Surrounds. This would configure your five-channel amp to be On whenever the Main Zone is On and any Input is selected, but *ONLY* if you have a mode that uses surround sound selected. Your Surrounds will be Off if you're using Reference Stereo or Direct Mode, but On if you use Dolby TrueHD or PLIIx.

The XMC-1 Menu System

The XMC-1 Menu System

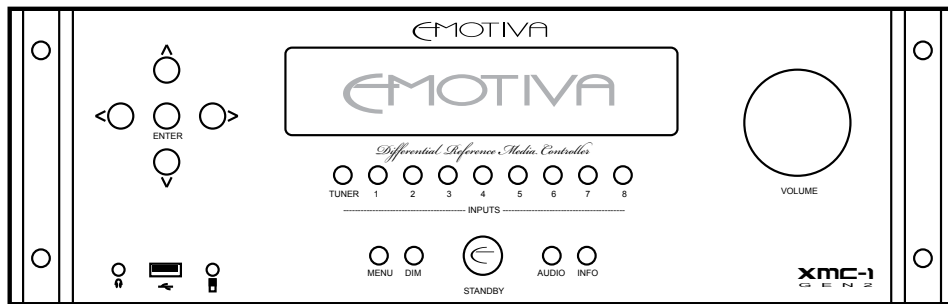

The XMC-1 Menu System

The front panel of the XMC-1 is dominated by a large, bright, easy to read blue OLED display. The XMC-1's front panel display can be set to any of six different brightness levels, including totally off. If the display is fully dimmed, it will illuminate for a few seconds when you press the Info button, and, when you activate the Menu, the display will illuminate for as long as you are using the Menu.

HDMI 1

HDMI 1	Surround	Volume -35.0dB
A: HDMI 1	PCM 7.1	48kHz 24bits
V: HDMI 1	1920x1080p/60	RGB 8bits

Volume -35.0dB

FM 104.90MHz	Surround	Volume -35.0dB
Mono 0dBuV		
V: HDMI 1	1920x1080p/60	RGB 8bits

By default, the front panel display shows three lines of detailed information about the source that is currently selected, and the audio and video modes currently in effect. When you operate a direct control, like the Volume knob or buttons, or one of the Input selector buttons, the display will momentarily switch to a large, easy to read, representation of the item being chosen or adjusted. When you use the Menu System, the display will switch to show that, then return to the Information screen when you exit the Menu. When using the Setup Menu, settings made on any screen are automatically updated or saved when you exit the screen.

For all menus *except* the Setup Menus, the on screen display will show the same content as the front panel display. In the Setup Menus, if a certain menu screen displays a list of more than three items, the front panel display will show the current item and a single item above and below it, while the on-screen display shows the entire list of items. Also, in the Setup Menu, certain menus show additional useful information on the OSD version (like the user defined name of the Presets).

The XMC-1 Menu System

This is what the front panel menu on the XMC-1 looks like when configuring the various settings for the HDMI 1 Input in the Setup | Inputs Menu.

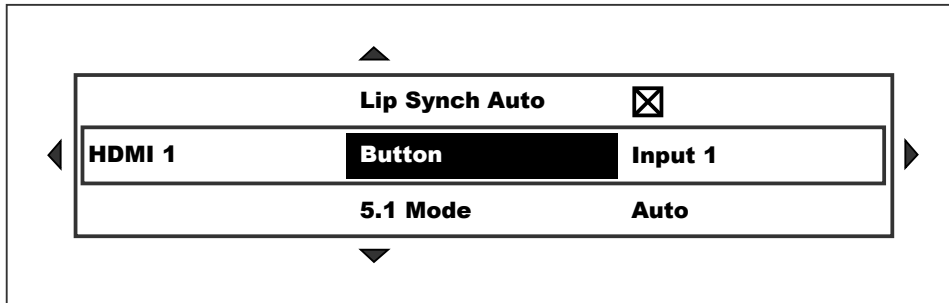

This is what the same Setup | Inputs Menu for HDMI 1 looks like in the on-screen display.

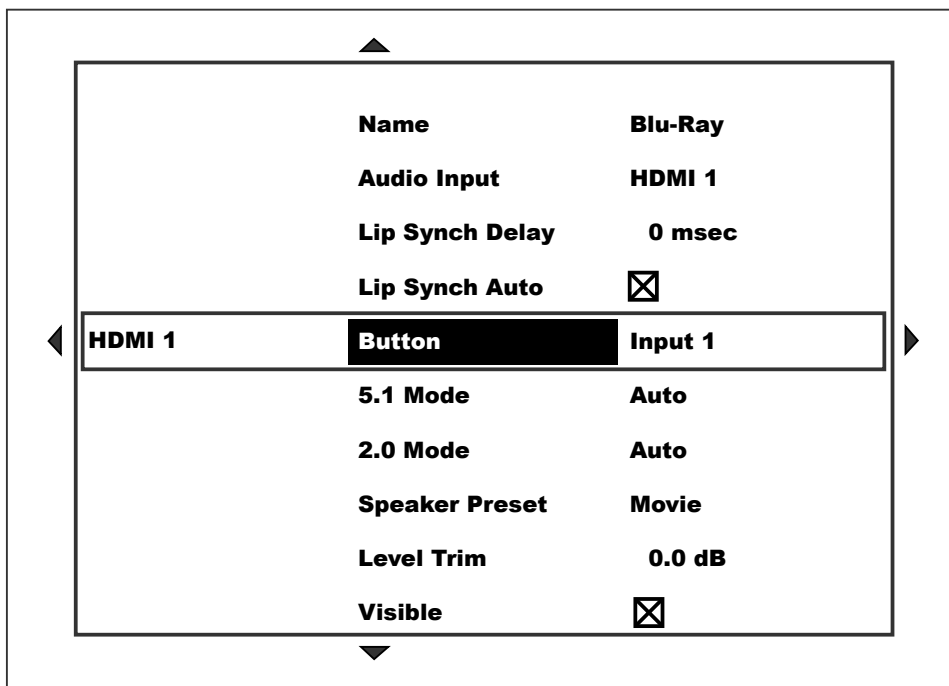

The XMC-1 Menu System

The Menu System is entered by pressing the Menu button on the XMC-1's front panel, or on the remote control; pressing the button a second time, or pressing the Left arrow button when you are already at the top level of the menu, exits the menu and returns you to the Information Screen. Menu navigation is accomplished using the Up, Down, Left, Right, and Enter buttons on the front panel or the remote control.

The menu system of the XMC-1 is intuitive, and was carefully optimized to make the XMC-1 not only flexible and powerful, but easy to use.

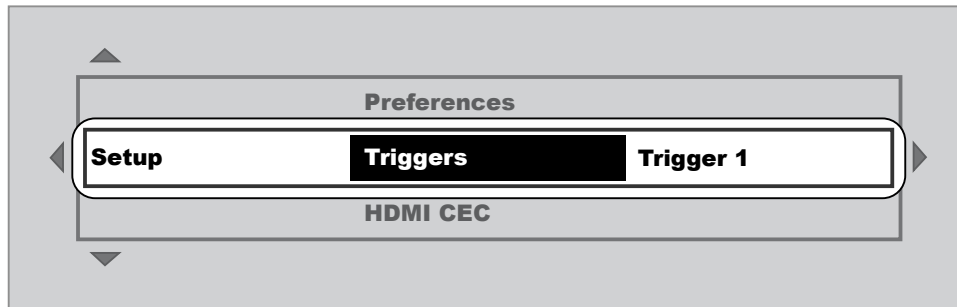

When using the Menu System, the center line of the menu is active. The lines above and below the active center line remain visible to provide context.

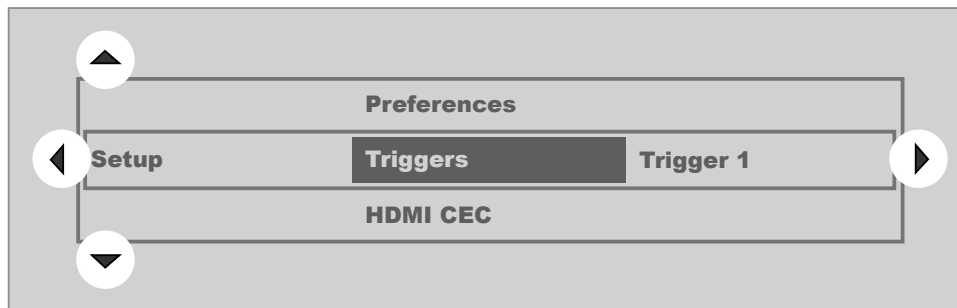

The small arrows to the left, right, above, and below show you which directions you can move in the menu from your current location.

The XMC-1 Menu System

This example will show you exactly how the process works, although it seems a lot more complicated on paper than it does in real life. Once you have an XMC-1 in front of you in person, you'll see how simple and intuitive the XMC-1 Menu System really is.

In this example we'll configure Trigger 1 to come on when the Main Zone Power is On and When Zone 2 Power is On.

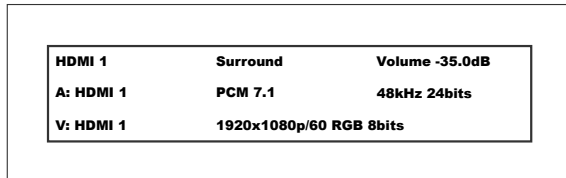

In normal operation the XMC-1 will usually display the Information Screen.

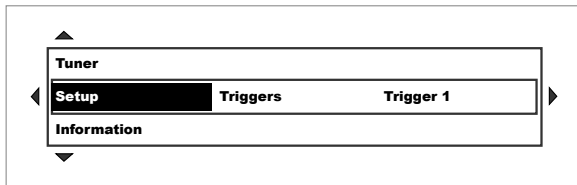

Press the Menu button, which brings up the Main Menu screen. The highlight shows that the Setup Menu is already the active choice, and the arrows show that we can move up to the Tuner Menu or down to the Information Menu.

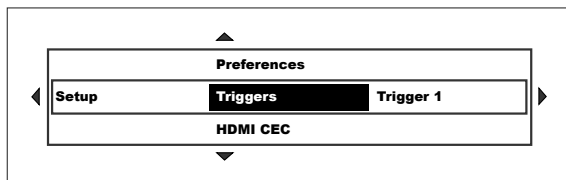

Press the Right arrow button to enter the Setup Menu. Now the highlight shows that the active choice is Triggers, and we can move up to the Setup Preferences Menu or down to the Setup Network Menu. Use the Right arrow button to move to the Setup Triggers Menu.

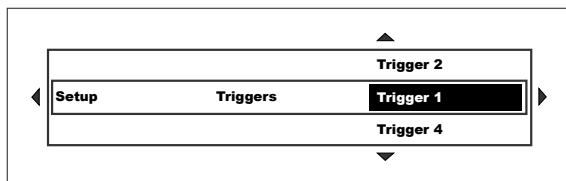

Since we want to configure one of the Triggers, use the Up, Down, and Right arrow buttons to select the particular Trigger we want. At this point the arrows show that we can move up or down to select the Trigger we want to configure. Since Trigger 1 is already the active choice, use the Right arrow button to select it and enter into the Trigger 1 section of the Setup Triggers Menu.

The XMC-1 Menu System

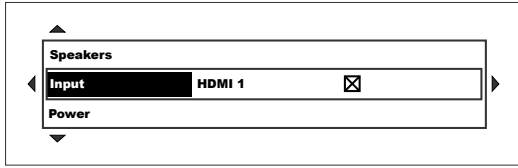

This time the highlight is showing us that the active choice is to configure how Trigger 1 responds to each Input. Since this time the default choice is not the one we want, use the Down arrow button to move to Power, which is the option we want.

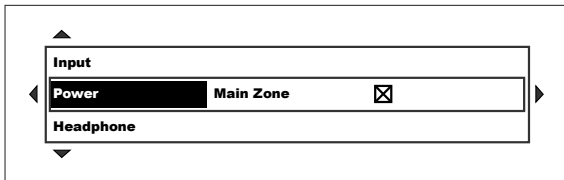

Now the highlight is showing the choice we want, so use the Right arrow button to select it and move into that part of the menu.

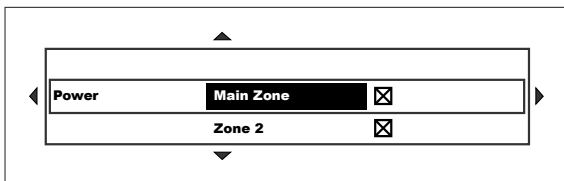

As you can see, we're in the final menu screen for configuring how Trigger 1 will respond to Power conditions. All we have to do is use the Up and Down arrow buttons to select Main Zone, and then Zone 2. Then, for each of those, use the Right arrow button to move to the check box, the Up and Down arrow buttons to check the box, and the Left arrow button to move back to where we are. After we've checked the box for both zones, we'll use the Menu button to exit back to the Information screen.

Note: Since, in our example, we wanted Trigger 1 to remain active when any combination of Inputs and Speakers was used, we left the Inputs and Speakers check boxes set to their default condition - which is "all checked".

Note: Whenever you use the Left arrow button to exit a Menu screen, or use the other arrow buttons to move around the Menu System, all changes you've made in any screen you leave are automatically saved: check a box and it stays checked; uncheck a box and it stays unchecked; change a value and it stays where you set it. You don't have to remember to save settings, or to exit the Menu screen using the correct button. And, at any point, you can exit the Menu System using the Menu button and all your settings will be saved.

Note: Before experimenting with new options or settings, we recommend that you save your current configuration; that way you can discard your changes and return to it if you change your mind. See [Creating a Configuration Backup on page 86](#) for details.

Once you try the XMC-1's menu system for a few minutes, you'll realize how incredibly intuitive it really is - and how easy it makes controlling the amazing power and flexibility of the XMC-1.

The XMC-1 Menu System

Main Menu

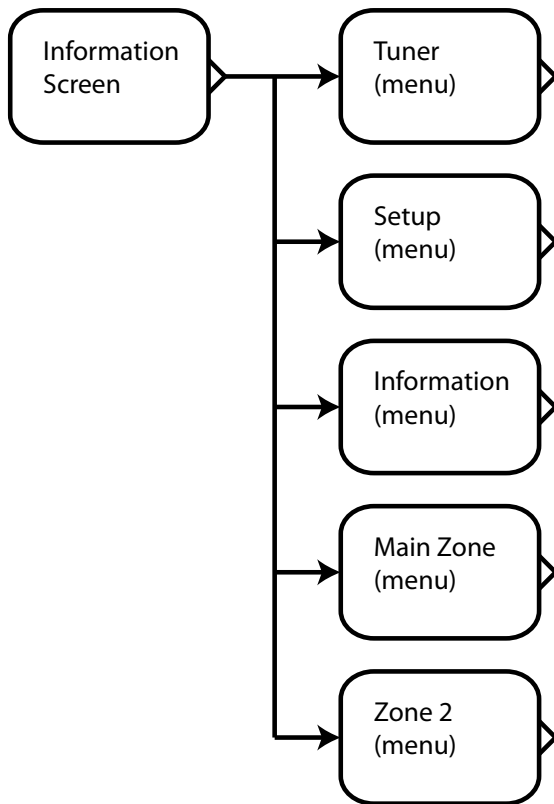

The XMC-1 **Menu System** is displayed by pressing the Menu button, and is displayed on the XMC-1's front panel display and the on-screen display. The Menu System is divided into five major functional categories.

Tuner (menu)

The Tuner menu provides the controls used to operate the XMC-1's built-in high quality AM/FM tuner. Station Presets and Station Names are also configured from this menu.

Setup (menu)

The Setup menu provides all the controls used to configure the XMC-1's various features and settings. These will be covered in detail in the Setup Menu section.

Information (menu)

The Information menu displays information about the XMC-1's Network Address and about the currently installed versions of the XMC-1's various firmware modules.

Note: Information displayed on this screen is read-only. The XMC-1's Network information and Friendly Name can be changed from the Setup Menu if desired.

Main Zone (menu)

The Main Zone menu provides the controls used to operate the XMC-1's main listening zone in day-to-day use, including Input and Mode selection and the Tone and Level Trims.

Note: Trim adjustments made in the Main Zone menu are temporary and are not saved when the XMC-1 is shut down. To make permanent adjustments, use the Setup menu

Zone 2 (menu)

The Zone 2 menu provides the controls used to operate the XMC-1's second listening zone in day-to-day use.

The XMC-1 Menu System

Tuner Menu

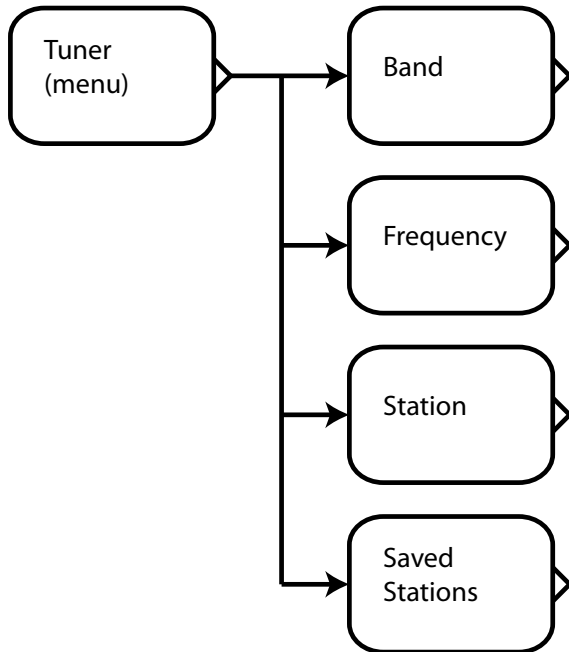

The **Tuner Menu** is used to select a station on the XMC-1's built-in high quality AM/FM tuner, and to create, rename, and delete station presets.

Band & Frequency

The Band and Frequency controls are used to select a radio station to listen to by number (frequency). To do so, simply select the appropriate band (AM or FM) and frequency of the station you wish to listen to.

Station

The Station control is used to select a station to listen to by name. (With this option, you will be able to select any station you have saved and named.)

Saved Stations

The Saved Stations control will act differently depending on whether the station you are currently on has already been saved as a Preset station or not.

If the currently selected station has NOT already been saved - then you will be offered the option to Add it to your list of preset stations. After you choose to Add the current station, you will be offered the option of entering a name for it.

If the currently selected station has already been saved in your list of presets - then you will be offered the choices of Renaming the station preset, or of Forgetting it (deleting it from the list).

Information Menu

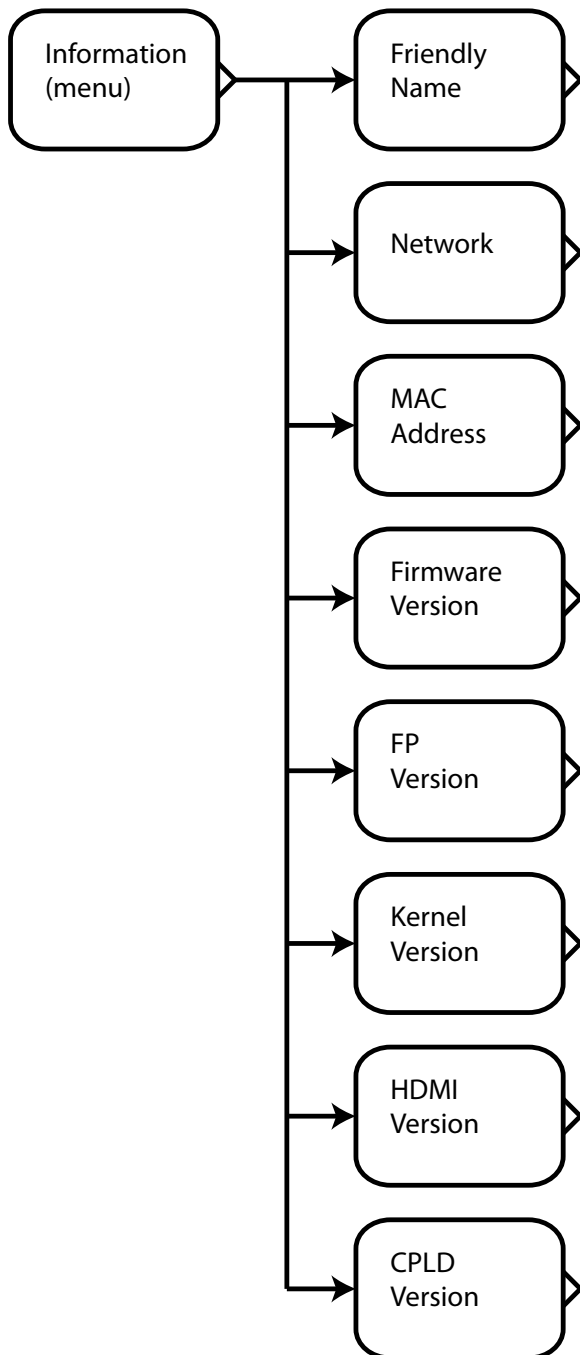

The **Information Menu** gives you access to information about the current Network configuration of the XMC-1, shows the versions of the currently installed firmware modules, and allows you to see the XMC-1's Friendly Name.

The information displayed on this screen is configured from other screens in the Setup Menu and cannot be changed from this screen.

Friendly Name

The Friendly Name is used by various remote control applications to identify the XMC-1 (the default is "XMC-1").

Network

The Network Address is the IP address assigned to your XMC-1. If the XMC-1 is configured to use DHCP, then this address is set by your DHCP server; otherwise it may be entered manually. A valid Network Address is required to configure Dirac Live, and to control the XMC-1 using a network attached remote control. If your XMC-1 isn't connected to a network this address may show as 0.0.0.0 (none).

MAC Address

This is the hardware address assigned to the network interface on the XMC-1. This address may be requested by some routers in order to allow the XMC-1 to access the Internet.

Firmware Version

This is the current version of the main XMC-1 firmware installed on your XMC-1.

The XMC-1 Menu System

FP Version

This is the current version of the Front Panel firmware installed on your XMC-1.

Kernel Version

This is the current version of the operating system kernel installed on your XMC-1. The XMC-1 operates on a highly-customized version of the Linux operating system.

HDMI Version

This is the current version of the HDMI firmware installed on your XMC-1.

CPLD Version

This is the current version of the CPLD firmware installed on your XMC-1.

The XMC-1 Menu System

Main Zone Menu

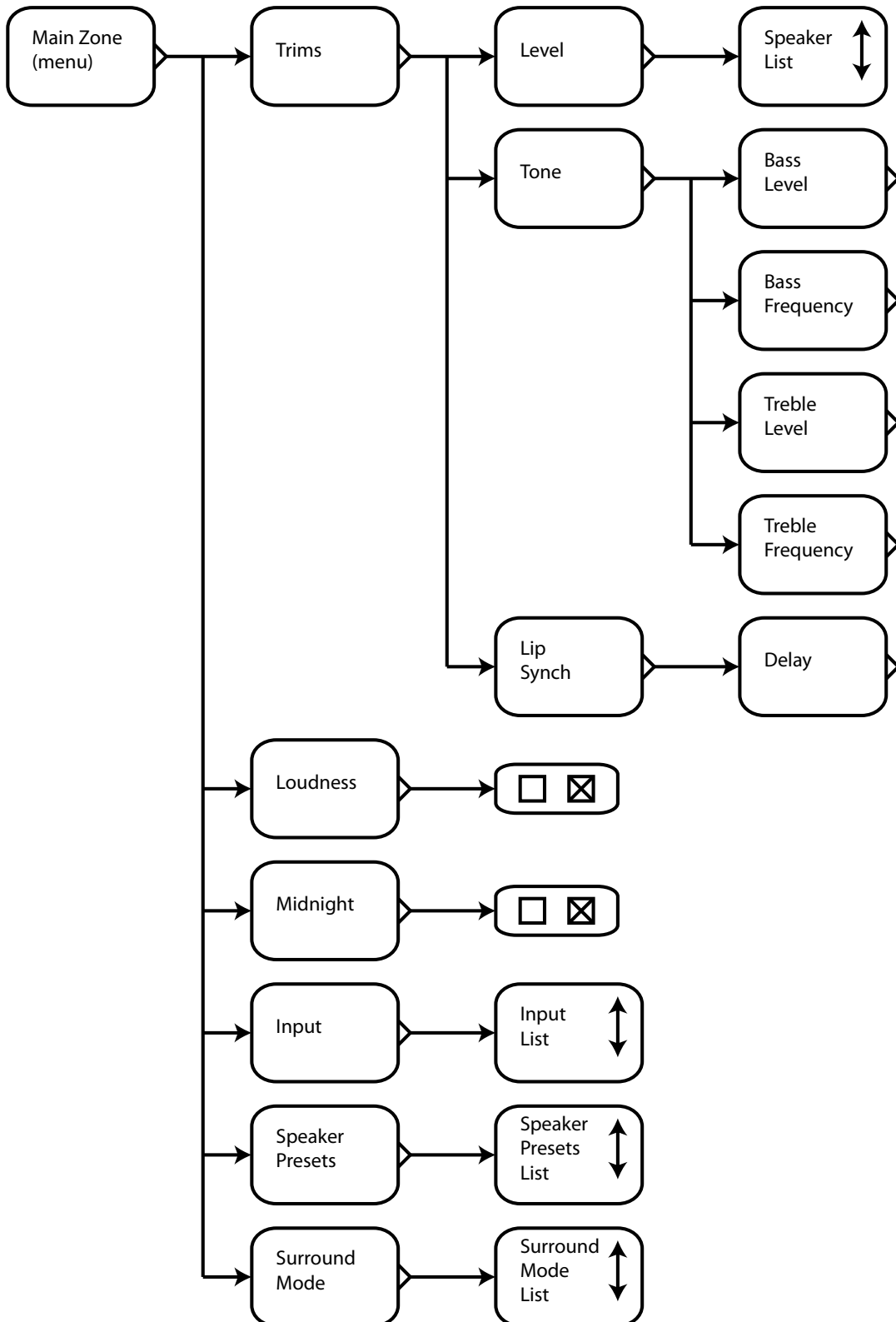

The XMC-1 Menu System

The **Main Zone Menu** contains the settings and controls typically used in the day-to-day operation of your XMC-1. These are settings that are typically chosen each time when viewing content; settings that remain in effect across multiple viewing sessions are accessed from the Setup Menu.

Note: The Level and Tone Trim settings on the Main Zone Menu are temporary trim settings, and apply only to the current listening session. To make changes to these settings that will persist after you restart the XMC-1, you will need to change them in the Setup Menu.

Note: The default settings for several parameters on the Main Zone Menu will be dependent on settings elsewhere in the Setup Menu.

For example, if you have previously set the Treble Adjustment for a given speaker to +5 dB at 5 kHz in the Setup Menu, the Treble Trim in the Main Zone Menu will still initially show the level for that speaker as 0 dB. If you then set the Treble Trim to +5 dB at 5 kHz, that adjustment will be ADDED to the other setting - with the result that Treble will actually be boosted by +10 dB at 5 kHz. If you set the Treble Trim to -5 dB at 5 kHz, it will be ADDED to the +5 dB setting in the Setup Menu - with the result that the Treble will actually be set to +0 dB (flat). When you restart your XMC-1, the Treble adjustment you made in the Setup Menu will remain in effect, while the Treble Trim adjustment you made in the Main Zone Menu will revert to the default +0 dB.

Note: While “stacking” controls for extra gain or cut at a specific frequency is usually not recommended, the XMC-1 will generally normalize the overall level to prevent clipping if you choose to do so.

Note: When the Tuner is selected as your Input, the middle row on the display will show the signal strength of the current station, and whether it is being received stereo or monaural. Since there is no video signal associated with the Tuner, the third row will continue to display information about the last selected video input.

Level Trim

The Level Trim is used to temporarily alter the relative level of each set of speakers. For each set of speakers you may change the level by up to +/- 12 dB in 0.5 dB steps.

Bass Level Tone Trim & Bass Frequency Trim

The Bass Level Tone Trim is used to temporarily alter the relative level of the bass for all speakers by up to +/- 12 dB in 0.5 dB steps.

The Bass Frequency Trim allows you to configure the turnover frequency for the Bass Level Tone Trim to any frequency between 40 Hz and 400 Hz.

Treble Level Tone Trim & Treble Frequency Trim

The Treble Level Tone Trim is used to temporarily alter the relative level of the treble for all speakers by up to +/- 12 dB in 0.5 dB steps.

The Treble Frequency Trim allows you to configure the turnover frequency for the Treble Level Tone Trim to any frequency between 500 Hz and 10 kHz.

The XMC-1 Menu System

Note: The Level Trims, Bass and Treble Trims, and Lip Synch Delay Trim in the Main Zone Menu are independent of those in the Setup Menu and changes configured in the trims operate IN ADDITION TO the levels and settings configured in the Setup Menu.

Lip Synch Delay Trim

The Lip Synch Delay Trim adjusts the lip synch delay from 0 mSec to 200 mSec in 1 mSec steps.

Loudness

The Loudness check box allows you to enable or disable true Fletcher Munson loudness compensation. Loudness compensation adjusts the audio frequency response to compensate for the varying frequency response of human hearing at low volume levels. Our hearing is increasingly less sensitive to very high and very low frequencies as the listening level is reduced, and the Fletcher Munson loudness curve compensates for this by applying a boost to those frequencies that increases as the level is reduced.

Midnight

Engages Dolby Midnight Mode (only affects the audio level if Midnight Mode settings have been encoded in the source material you are listening to.)

Input

The Input control is used to select which input on the XMC-1 to listen to or view. Inputs may also be assigned to individual Input Select buttons in the Setup Menu.

Speaker Presets

The XMC-1 has both Dirac Live automatic room correction, and two full banks of parametric equalization that can be used for precise, detailed manual correction of room and system frequency response. The Speaker Preset control allows you to select between the Presets that you have configured in the Setup Menu; listed by the names you have assigned.

Note: Your XMC-1 is configured to use the Presets, and Dirac Live Automatic Room Correction, from the Setup Menu, under Setup Speakers. Dirac Live is executed and configured from a separate computer, which must have network access to connect to the XMC-1 and the Internet.

Surround Mode

The Surround Mode control is used to select which surround mode is used by the XMC-1 to decode incoming audio. This control will present you with a list of available modes and allow you to override the XMC-1's default selection. Selecting Auto on this menu will instruct the XMC-1 to automatically choose the best decoding and processing modes based on the incoming audio.

Note: The XMC-1 will automatically detect the surround mode used by incoming audio and only allow you to choose modes that are appropriate for the type of incoming signal that is detected. If you set the XMC-1 to Auto, it will automatically select the best choice for a given type of input signal; if you configure a specific mode, then that mode will be used; if you configure the XMC-1 to Last Used, then it will use the same surround mode that you manually selected the last time a similar type of input signal was detected.

The XMC-1 Menu System

Zone 2 Menu

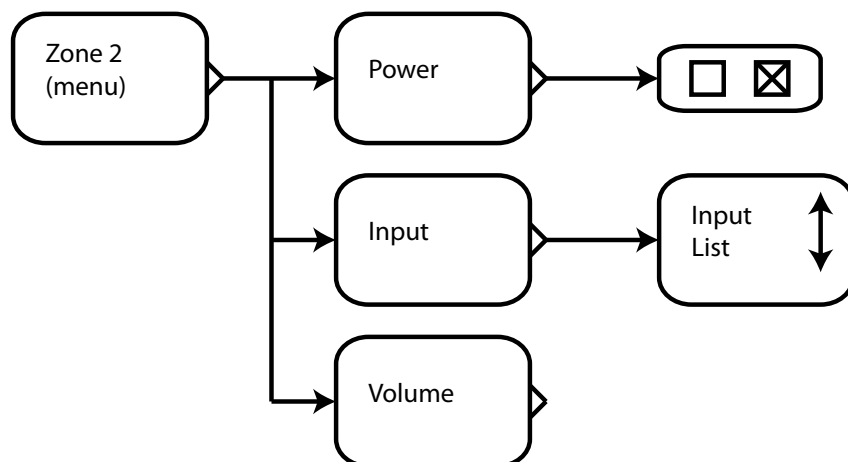

The **Zone 2 Menu** contains the settings and controls typically used to control the second audio zone in the day-to-day operation of your XMC-1. These are settings that are typically chosen each time when viewing content.

Power

The Power check box is used to turn Zone 2 On and Off from the menu system. Zone 2 can also be turned On and Off directly from the remote control.

Input

The Input control is used to select which input on the XMC-1 to listen to or view.

Note: On the XMC-1, the Zone 2 Input is selected independently from the main zone. ANY input that is currently selected as the Main Zone Input can also be routed to the Zone 2 Input - by selecting Follow Main. If you wish to set the Zone 2 Input to a different source than the main zone, you will be able to select ANALOG sources, and 2 CHANNEL PCM DIGITAL sources. You will NOT be able to select a different digital surround sound or HDMI source for the Zone 2 Input than is selected for the Main Zone.

Note: The halo ring on the front panel Standby button will flash alternating blue and amber to remind you when Zone 2 is On.

Note: If the Video On Standby feature is enabled, or the Main Zone is already On, Zone 2 will respond very quickly when turned On. If the Video On Standby feature is disabled, and the XMC-1 Main Zone is Off, then the XMC-1 will have to load its operating system when Zone 2 is turned On, which may take up to one minute

Volume

The Volume control is used to control the level of the Zone 2 output from the menu system. Zone 2 Volume can also be set directly from the remote control.

The XMC-1 Menu System

Setup Menu

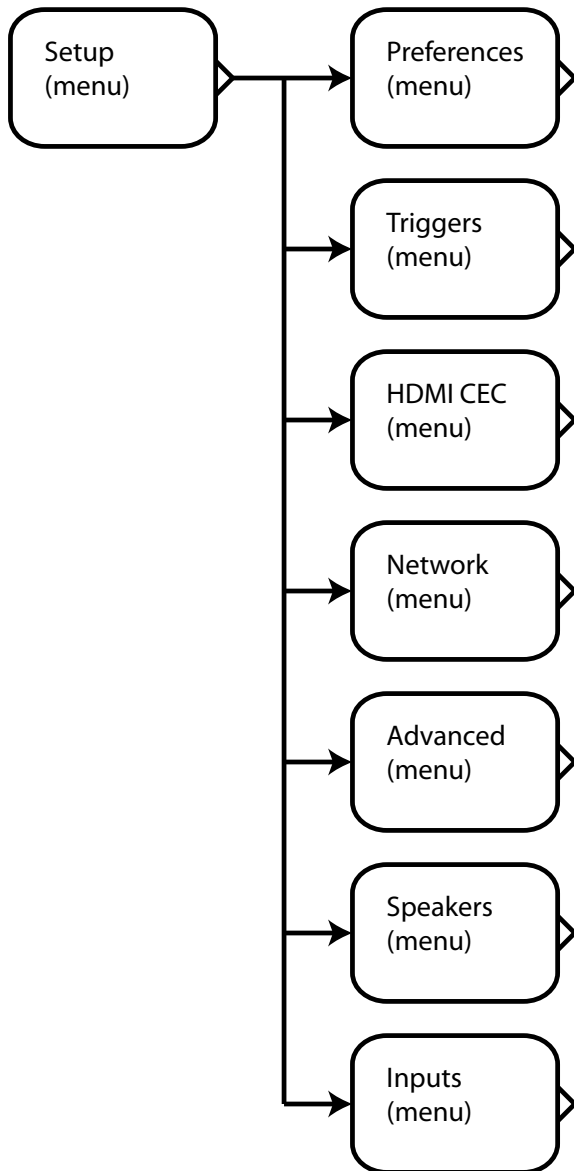

The **Setup Menu** allows you to view and change the main configuration settings for the XMC-1.

Setup | Preferences Menu

The **Preferences Menu** is used to configure various system operating preferences, including Max Volume, Turn-On Volume and Input, and the behavior of the OSD pop up.

Setup | Triggers Menu

The **Triggers Menu** is used to configure the behavior of the XMC-1's four independent triggers.

Setup | HDMI CEC Menu

The **HDMI CEC Menu** is used to configure how the XMC-1 participates in sending and receiving CEC commands.

Setup | Network Menu

The **Network Menu** is used to configure various network parameters for the XMC-1.

Setup | Advanced Menu

The **Advanced Menu** allows you to configure various system operating preferences, including selecting a Standby Mode, and enabling various controls and remote control inputs and outputs. Firmware updates, and resetting your XMC-1 to factory defaults, are also initiated from this menu.

Setup | Speakers Menu

The **Speakers Menu** is used to configure your speakers and room correction, including Dirac Live automatic room correction and manual EQ using the XMC-1's built-in test tones and parametric equalizers.

Setup | Inputs Menu

The **Inputs Menu** is used to configure each Input on the XMC-1, including the Input Name and how the XMC-1 handles various types of input signals on each input.

Setup | Preferences Menu

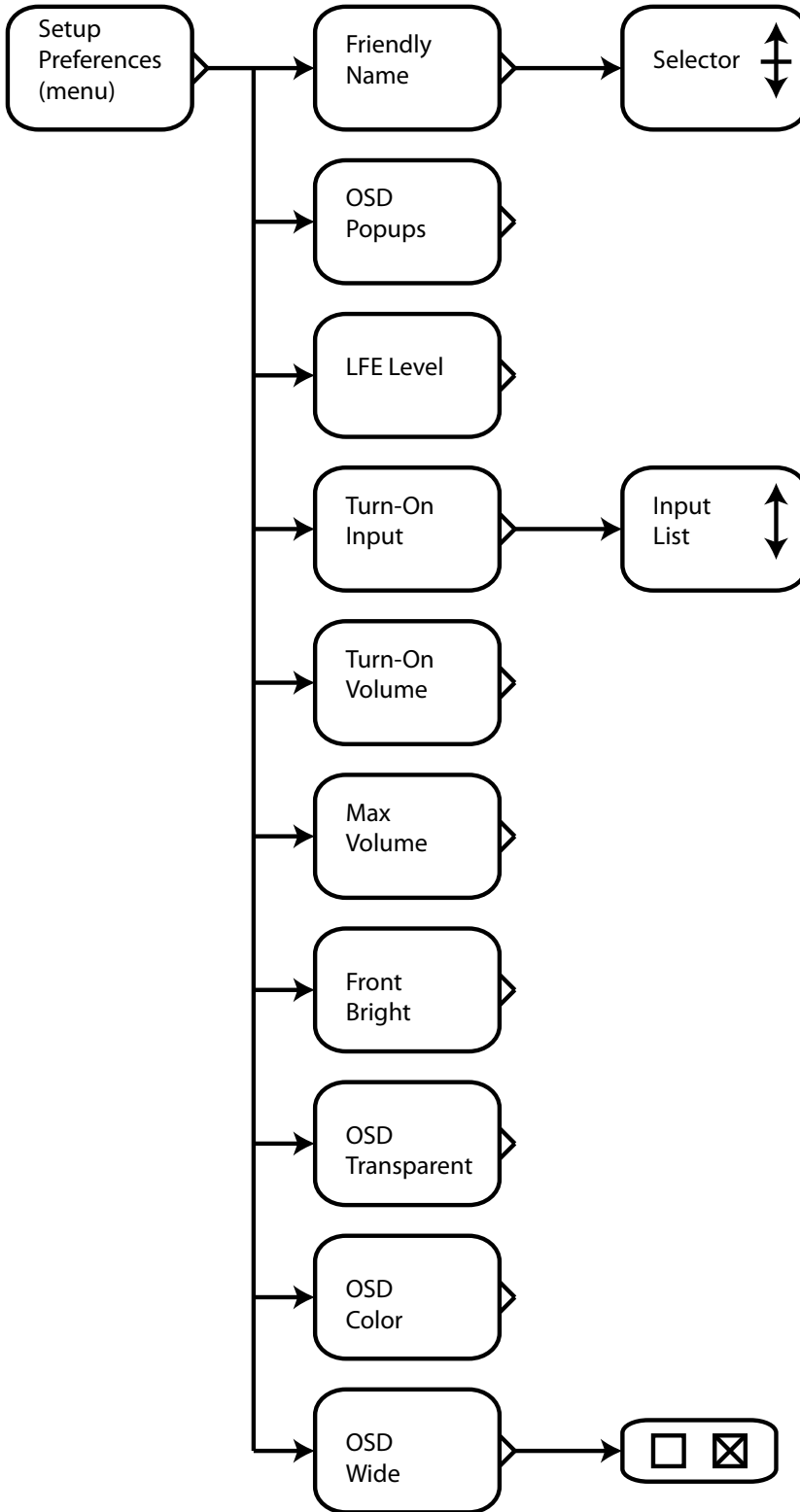

The **Setup Preferences Menu** allows you to configure various general system settings and defaults.

Note: Settings configured in the Setup Preferences Menu remain in effect after the XMC-1 is shut down and restarted.

Friendly Name

The Friendly Name is used by various remote control applications to identify the XMC-1. Up to 10 characters may be used; the default value is "XMC-1".

OSD Popups

The OSD Popups option lets you configure when the pop up information box appears on the screen.

All causes the pop up box to appear whenever user input is received and whenever the incoming signal type or sample rate changes.

User causes the pop up box to appear whenever user input is received, but **NOT** when the incoming signal type or sample rate changes.

None disables the OSD pop up info box completely.

The XMC-1 Menu System

LFE Level

The LFE Level control allows you to adjust the level for the LFE channel for all inputs from 0 dB to -20 dB in 0.5 dB increments.

Turn-On Input

The Turn-On Input setting allows you to configure which Input on your XMC-1 is active when you first turn it on. If you select Last Used, then the input which was in use when the XMC-1 was shut down will be chosen.

Turn-On Volume

The Turn-On Volume setting allows you to configure the Volume Level your XMC-1 will default to when first turned on. Choices are -10 dB, -20 dB, -30 dB, -40 dB, -50 dB, -60 dB, and Last Used; if you select Last Used, then the Volume Level will return to where it was when the XMC-1 was shut off.

Max Volume

The Max Volume setting allows you to configure the maximum Volume Level which can be selected from the front panel Volume knob or the Volume buttons on the remote control. This setting controls the Volume setting in the Main Zone, and can be set from -30 dB to +11 dB in 1 dB increments.

Note; The Max Volume setting is a safety feature intended to prevent you (or other users) from accidentally turning the Volume on your XMC-1 up too high; it does NOT prevent Level Trims from raising the overall Level or gain of the XMC-1, or specifically limit input or output levels.

Front Brightness

The Front Bright control configures the brightness of the XMC-1's front panel OLED display. Display brightness can be set to 0, 20, 40, 60, 80, and 100. If the Front Bright is set to 0, then the front panel display will be entirely dark. If the Front Bright is set to 0, when the user makes an adjustment or operates a control the display will momentarily brighten so the results are visible, then return to full dark after a few seconds.

OSD Transparency

The OSD Transparent control configures the transparency of the XMC-1's OSD (on-screen display). Transparency can be set from 0% to 70% in 5% increments.

OSD Color

The OSD Color control allows you to pick from amongst several different "color themes" for the XMC-1's on-screen display.

OSD Wide

When OSD Wide is enabled, the on-screen display will be displayed at double its normal width, which may improve visibility on 4k screens.

The XMC-1 Menu System

Setup | Triggers Menu

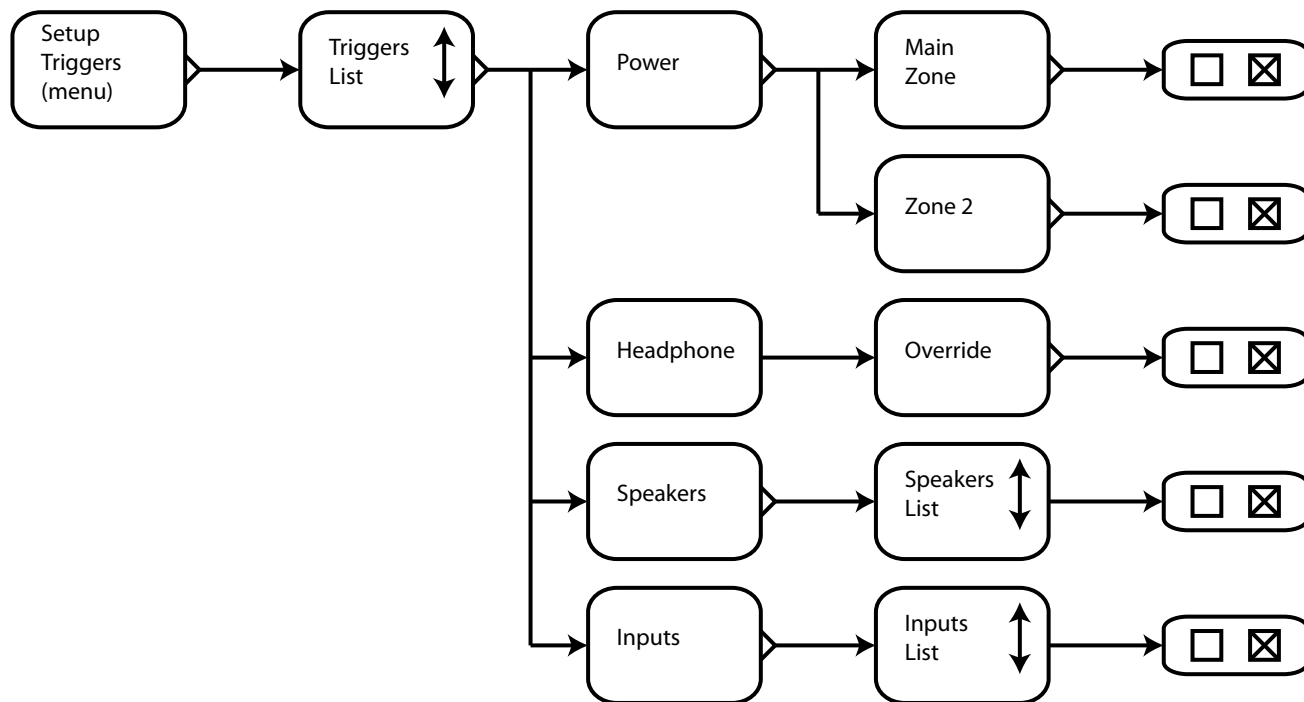

The **Setup Triggers Menu** allows you to configure how the triggers on the XMC-1 operate.

The XMC-1 has four fully independent triggers, each one of which may be configured to activate an associated piece of trigger-enabled equipment when specific conditions are met. For example, you could configure the triggers to activate the amplifiers that power your main front speakers whenever you play music, and the amplifier that powers your surrounds, and your powered subwoofer, to only be activated when you're listening to a surround sound source.

The triggers on the XMC-1 are configured by checking various boxes in the Setup Triggers Menu. All of the following options are available independently for each of the four triggers on the XMC-1.

For triggers associated with Zone 2, the trigger will be active whenever Zone 2 is On *AND* one of the Inputs associated with that trigger is selected.

For triggers associated with the Main Zone, there is an additional condition that must be met. For the Main Zone, each trigger must be associated with one or more Inputs *AND* also be associated with one or more Speaker groups. The trigger will be active whenever the Main Zone is On, *AND* one or more of the Inputs associated with that trigger is active, *AND* one or more of the Speaker groups associated with that trigger is active.

Power

Each trigger must be configured to be active when the Main Zone, Zone 2, or both zones are On. The trigger will *only* be active when at least one of the zones it is associated with are active. Under Power, check the zones for which you want the trigger to be active.

The XMC-1 Menu System

Inputs

Each trigger must be configured to be associated with one or more Inputs. The trigger will *only* be active when one or more of the Inputs it is associated with are active.

Speakers

For triggers associated with the Main Zone, the trigger will only be active when, in addition to the chosen Input, one or more of the Speaker groups associated with the trigger is active. A Speaker group is considered to be active when the speakers in the group are *NOT* set to None in the Speaker Size Menu, and when you are using a Mode that uses that Speaker group. (Surrounds will be active in modes like Dolby TrueHD and PLIIx, will not be active in Reference Stereo, and may or may not be active in Auto mode, depending on which Modes your XMC-1 has chosen to use.)

Note: The triggers respond based on how the XMC-1 is configured; the XMC-1 does not detect the presence or absence of an active audio signal on specific channels.

Note: The option to configure associated Speaker groups only pertains to the Main Zone. Therefore, if you only have Zone 2 checked for a particular trigger, the Speakers column will not be displayed. However, if you have both Zone 2 and the Main Zone checked for that trigger, the Speakers column will be displayed; but please remember that the settings in that column ONLY pertain to the Main Zone and don't affect the status of Zone 2 triggering .

By default, the triggers on the XMC-1 are configured as follows:

- Trigger 1: Main Zone (only), ALL Inputs, ALL Speakers
- Trigger 2: Zone 2 (only), ALL Inputs
- Trigger 3: Main Zone AND Zone 2, ALL Inputs, ALL Speakers
- Trigger 4: Main Zone AND Zone 2, ALL Inputs, ALL Speakers

Headphone

Since triggers are most often used to switch amplifiers On and Off, the triggers on the XMC-1 are normally configured to be disabled when a pair of headphones is plugged into the *front panel headphone jack*. If you uncheck the Headphone Override box for a particular trigger, this override will be disabled.

Note: The Headphone Override option is useful if you are using one of the XMC-1's triggers to activate your monitor, and you sometimes watch TV wearing headphones; if you uncheck the Headphone Override for that trigger, then that trigger will remain active (assuming the other configured conditions are met), even when headphones are plugged in.

Note: The XMC-1 detects when headphones are connected by sensing a plug physically inserted into the front panel Headphone jack. If you leave a headphone extension - with no headphones attached - plugged into the jack, the XMC-1 will act as if headphones are connected. Also, obviously, if you use a separate headphone amplifier connected to one of the XMC-1's outputs, the XMC-1 will be unaware that you're using headphones.

See **Configuring Triggers** on page 23 for more information and examples.

Setup | HDMI CEC Menu

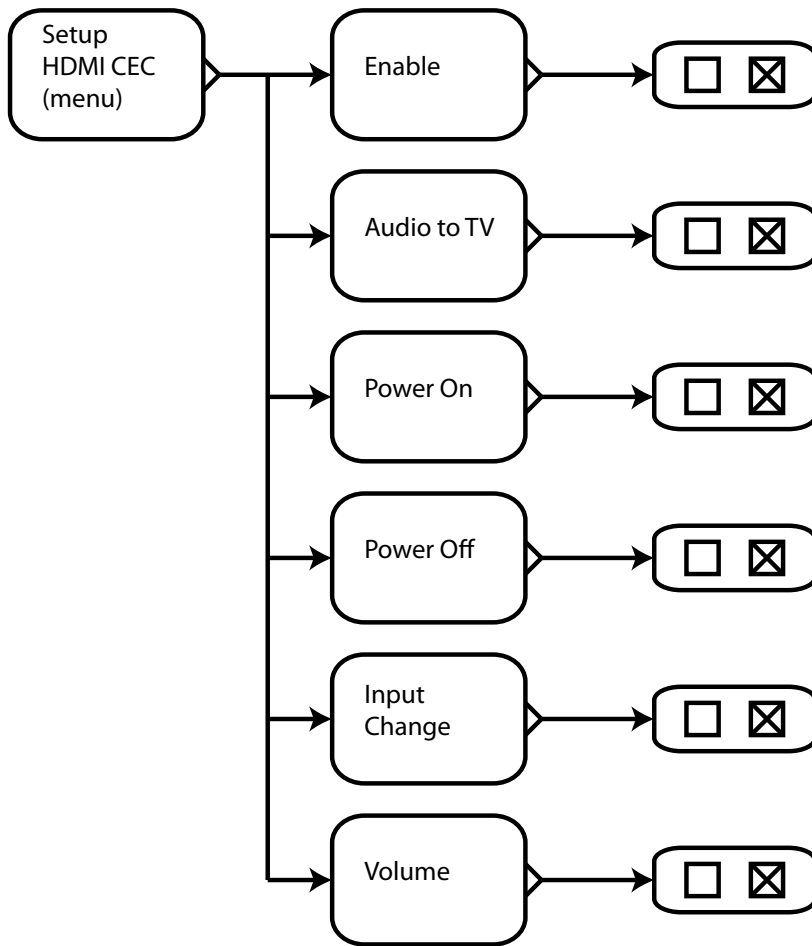

The **Setup HDMI CEC Menu** allows you to configure what types of CEC commands the XMC-1 sends and responds to.

Enable

This check box enables all CEC functionality on the XMC-1. When this box is unchecked, the XMC-1 will not respond to or issue CEC commands. The other options shown on this page will be hidden unless CEC is Enabled.

Audio to TV

Configures the XMC-1 to accept a command to send all audio to the TV for processing.

Note: *This command is used by some TVs to “steal audio” from the XMC-1. We normally recommend that it be left disabled.*

Power On

Configures the XMC-1 to accept a command to turn On from a connected CEC-enabled device.

Power Off

Configures the XMC-1 to accept a command to turn Off from a connected CEC-enabled device.

Input Change

Configures the XMC-1 to accept a command to switch inputs to display the output of a CEC-enabled device when commanded to do so.

Volume

Allows a CEC-enabled device to control the Volume setting on the XMC-1.

The XMC-1 Menu System

Note: CEC is a system that allows various audio and video components to issue commands to each other; for example, your Blu-Ray player may use CEC to instruct the XMC-1 to switch on and select its input when you insert a disc and press play. Many equipment manufacturers implement some form of CEC control, although they may call it something else, and the features and capabilities of each vary. Because each vendor interprets the CEC standard differently, CEC can cause unexpected and undesired things to happen.

The XMC-1 allows you to individually enable or disable several different CEC functions, allowing you to use the CEC features that prove useful in your system, while avoiding unwanted and unexpected interactions.

Note: The Audio Return Channel (ARC) feature on many TVs requires CEC in order to operate. Therefore, if you fully disable CEC on the XMC-1, you will probably not be able to configure ARC as your audio source.

Note: You do NOT need to have CEC Enabled in order to use Video on Standby Mode; and fully disabling CEC should NOT affect the audio on your TV when you're in Video on Standby Mode.

The XMC-1 Menu System

Setup | Network Menu

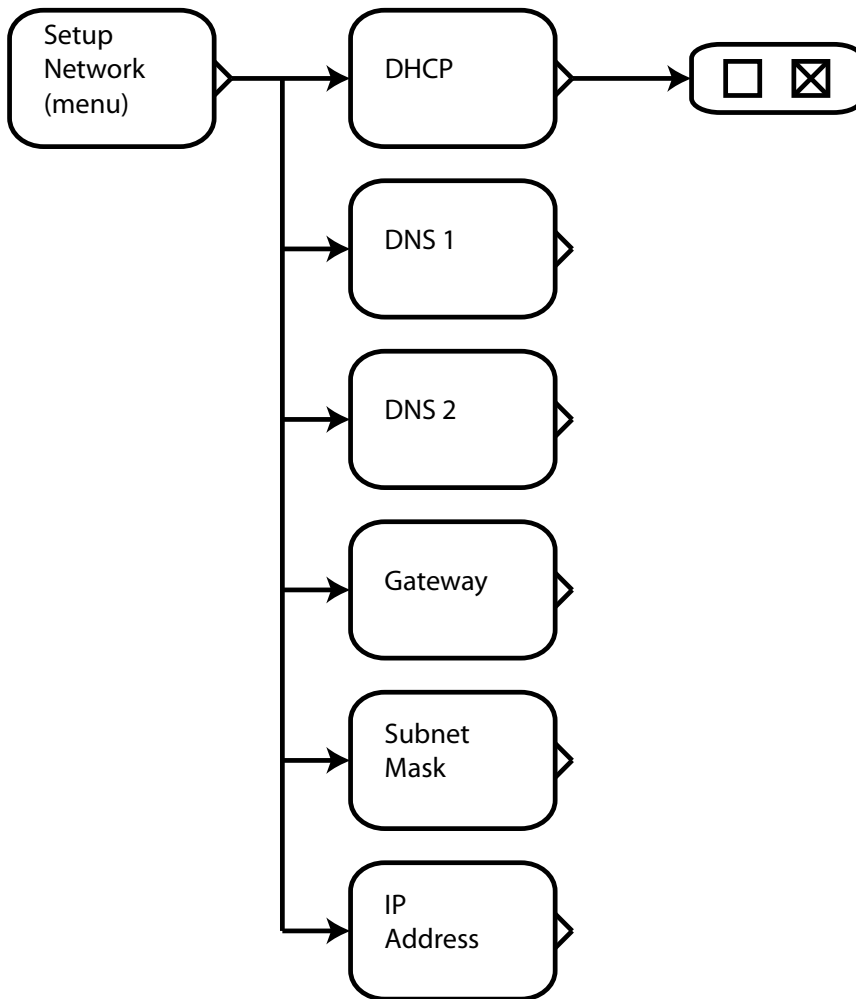

The **Setup Network Menu** allows you to configure various network parameters for the XMC-1.

Note: The XMC-1's Ethernet connection is used to connect the XMC-1 to the Internet via your home network. An Internet connection is required in order to configure Dirac Live automatic room correction, and to allow Ethernet-based or Internet-based remote control apps to connect to the XMC-1. Once Dirac Live is configured, the XMC-1 does NOT need to remain connected to the Internet - or your local network - to operate.

DHCP

If DHCP is selected, then the XMC-1 will obtain all network setup parameters from your local DHCP Server. If you have a cable modem or router, then it probably also provides a DHCP Server for your home network. If your network doesn't have a DHCP server, or you wish to set up the network configuration of your XMC-1 manually, then disabling the DHCP check box will allow you to set each parameter manually.

Note: Most users will find DHCP the best choice. If you prefer to configure your XMC-1 network parameters manually, please consult your network service provider or local computer expert about the appropriate addresses and subnet mask to enter.

Note: If you disable DHCP in the XMC-1's configuration after the XMC-1 has obtained network settings via DHCP, the settings already obtained will NOT be cleared. This can be used as a handy shortcut for manually configuring the network settings in your XMC-1; simply allow the XMC-1 to fill in all the network settings via DHCP, then disable DHCP and manually modify only the settings you wish to change.

Setup | Advanced Menu

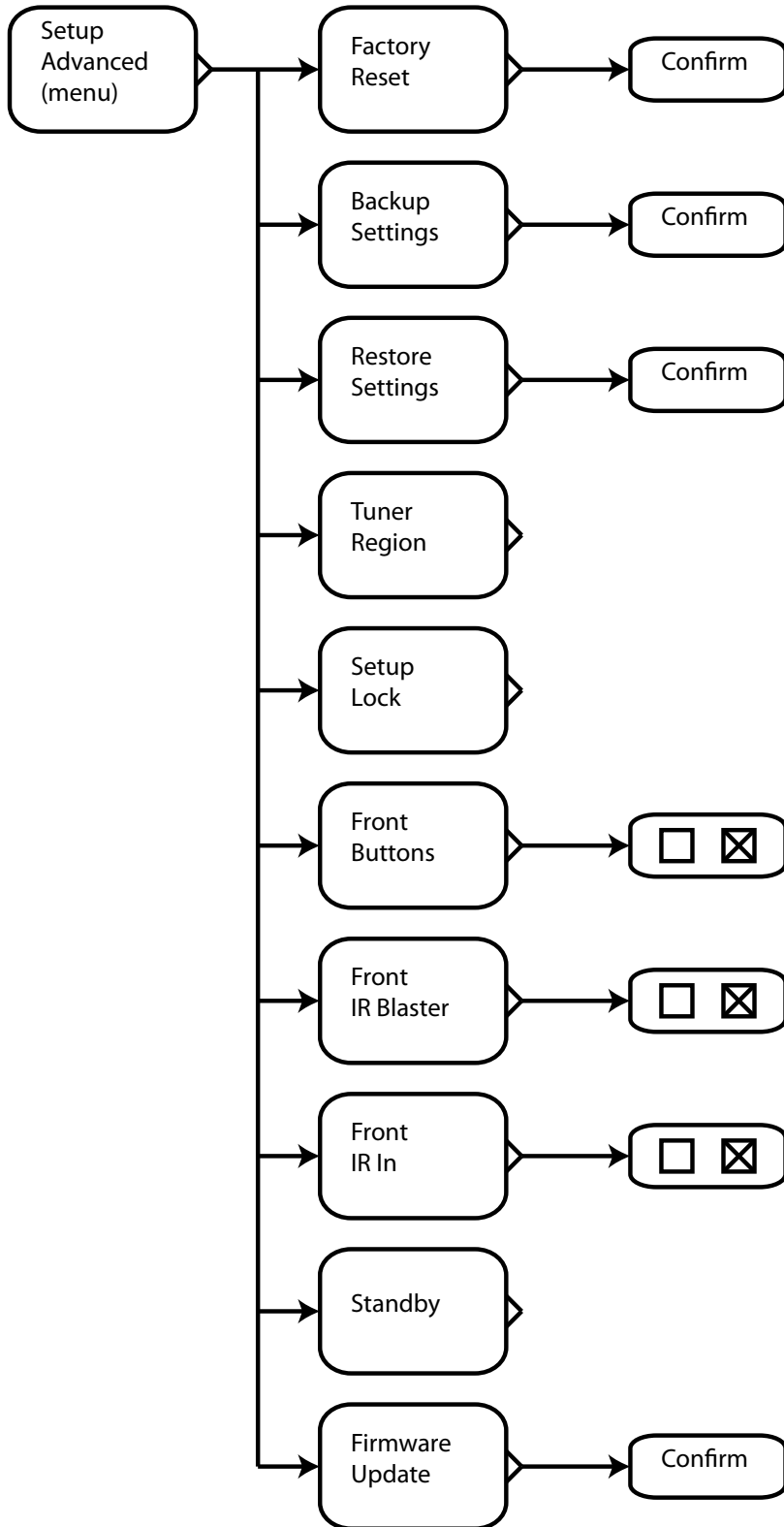

The **Setup Advanced Menu** allows you to configure various system operating preferences, including selecting a Standby Mode, and enabling various controls and remote control inputs and outputs. Firmware updates, and resetting your XMC-1 to factory defaults, are also initiated from this menu.

Factory Reset

Selecting Factory Reset clears all user settings and returns the XMC-1 to its factory defaults. After selecting Factory Reset you will be prompted to Confirm your choice. To do so, check the confirmation box, then use the Left arrow key to confirm the action.

Backup Settings

Selecting Backup Settings instructs the XMC-1 to save a copy of its configuration file. After selecting Backup Settings you will be prompted to Confirm your choice.

Note: *If a USB stick is inserted in the XMC-1, the configuration will be stored there. If no USB stick is inserted, then the configuration will be stored internally.*

The XMC-1 Menu System

Restore Settings

Selecting Restore Settings instructs the XMC-1 to retrieve a stored copy of its configuration file and apply the stored configuration. After selecting Restore Settings you will be prompted to Confirm your choice.

Note: If a USB stick is inserted in the XMC-1, the configuration stored there will be used. If no USB stick is inserted, or no external configuration file is present, then the configuration that is stored internally will be used.

Tuner Region

The Tuner Region setting is used to configure the tuner in the XMC-1 to comply with the correct channel frequency spacing for your region. You may select either **Americas** or **Europe/Asia**.

Setup Lock

Setup Lock is used to prevent the XMC-1's configuration settings from being inadvertently changed.

Selecting **None** will leave all configuration settings unlocked. This is the normal default configuration.

Selecting **Advanced** locks the Setup Advanced Menu - which will then no longer appear on the Setup Menu. This prevents anyone from inadvertently changing any settings on the Setup Advanced Menu, which include resetting the XMC-1 to factory defaults.

Selecting **All** locks the entire Setup Menu.

Note: If you lock the entire Setup Menu - by selecting All, or just the Setup Advanced Menu - by selecting Advanced, you will no longer have access to the Setup Advanced Menu, which will prevent you from changing the lock settings. This will prevent you from unlocking the menus. If you find yourself in this situation, you may still access the Setup Advanced Menu directly by pressing the Menu button on the front panel WHILE HOLDING DOWN THE FRONT PANEL ENTER BUTTON.

Front Buttons

Check this box to disable all front panel controls.

Note: This feature is intended to prevent settings on the XMC-1 from being inadvertently changed (and also acts as a "child lock"). If you accidentally become locked out of the XMC-1 by disabling all controls, including the remote control, you can override this feature and access the Setup Advanced Menu by HOLDING THE ENTER BUTTON DOWN WHILE PRESSING THE MENU BUTTON (both on the front panel). This will allow you to enter the Setup Advanced Menu and re-enable the controls.

Front IR Blaster

Use this check box to disable the front panel IR blaster.

The XMC-1 Menu System

Front IR In

Check this box to disable the front panel IR Input.

Note: When the front panel IR Input is disabled, the remote control will NOT function unless an external IR remote sensor ("eye) is used.

Standby

Use this option to enable the XMC-1's Video on Standby feature.

Selecting **Video Remains On** will configure the XMC-1 to use its Video on Standby Mode. When this mode is selected, the XMC-1 will continue to pass video and audio from the selected input source to the display, and will allow you to change the Input source, even when the XMC-1 is in Standby Mode. The XMC-1 uses slightly more power when in Standby Mode if Video on Standby Mode is enabled.

Selecting **Lowest Power** will configure the XMC-1 to use its lowest power Standby Mode. In this mode, video and audio will NOT be passed to the display when the XMC-1 is in Standby Mode.

Note: When the XMC-1 is set to Video on Standby Mode, the XMC-1 Operating System remains loaded when the XMC-1 is in Standby Mode. Because a significant portion of the start up time on the XMC-1 is used to load the operating system, setting the XMC-1 to use Video on Standby Mode will considerably shorten the amount of time it takes the XMC-1 to wake up from Standby Mode.

Note: The start-up sequence on the XMC-1 is different depending on which Standby Mode you have configured the XMC-1 to use.

In Lowest Power Mode, turning the XMC-1 On using the rear panel Power switch will cause it to immediately enter Standby Mode (halo ring around the Standby button lit amber). Pressing the Standby button will then cause the XMC-1 to load the XMC-1 Operating System and turn fully On. The XMC-1 Operating System is loaded during this start up sequence, which may take up to one minute. Pressing the Standby button when the XMC-1 is On will cause it to return to Standby Mode (and unload the operating system).

In Video on Standby Mode, turning the XMC-1 On using the rear panel Power switch will cause it to first load the XMC-1 Operating System, then return to Standby Mode. (While the operating system is loading, the halo ring around the Standby button will illuminate blue. Once the operating system is loaded, the XMC-1 will drop into Standby Mode and the halo ring will change to purple.) Since the operating system remains loaded while the XMC-1 is in Standby Mode, switching between On and Standby Mode can then be accomplished very quickly.)

Firmware Update

Selecting Firmware Update instructs the XMC-1 to load a firmware update from the inserted USB stick. After selecting Firmware Update you will be prompted to Confirm your choice. Use the Up Arrow to confirm that you want to perform a Firmware Update, then the Left Arrow to start the update process. **DO NOT TURN OFF YOUR XMC-1 UNTIL THE FIRMWARE UPDATE PROCESS HAS COMPLETED!**

Setup | Speakers Menu

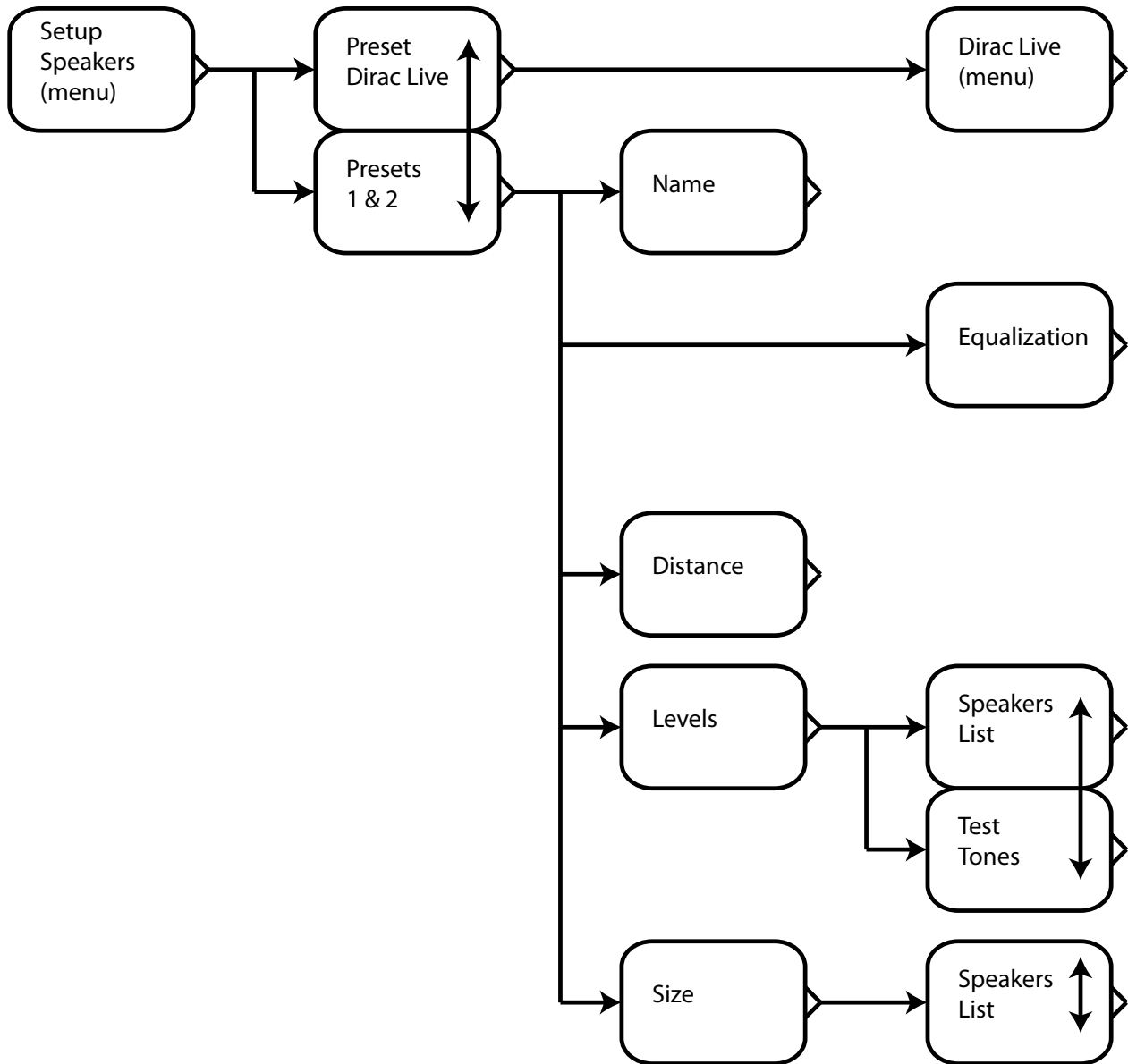

The **Setup Speakers Menu** is where you access the powerful speaker and room correction features of the XMC-1, including Dirac Live automatic room correction, and the XMC-1's incredibly flexible manual calibration system, which includes two fully independent banks of parametric equalizers, along with pink noise and test tone generators.

When you first enter the Setup Speakers menu, you will be asked to choose between Dirac Live automatic room correction and the two available EQ presets. (When you configure the EQ presets, you will get to assign each a name, which will then appear when you Setup Inputs and when you choose a preset in the Setup Speakers Menu; the default names for the two presets are Preset 1 and Preset 2.)

The XMC-1 Menu System

If you chose Dirac, you will be sent to the Dirac Live Menu.

If you choose to manually configure a preset, you will be prompted to choose Preset 1 or Preset 2, and the following settings will be available for EACH preset.

Name

The Name setting allows you to set an alphanumeric “human friendly” name for each Preset.

Distance

The Distance setting will present you with a list of speakers, and allow you to manually enter a distance measurement for each.

Size

The Size screen will enable you to configure the sizes, crossover frequencies, and crossover slopes for your speakers, the configuration of your Rear Surround speakers, and the configuration of your subwoofers.

For your **Front** speakers you will be able to select: Small or Large.

For your **Center** speaker you will be able to select: Small, Large, or None.

For your **Surround** speakers you will be able to select: Small, Large, or None.

For your **Back (Rear Surround)** speakers you will be able to select:

2 Large, 2 Small, 1 Large, 1 Small, or None.

For each type of speaker you set to Small, you will be able to set a **Crossover Frequency** between 40 Hz and 200 Hz in increments of 10 Hz.

For **Subwoofer** configuration you will be able to select Mono, Stereo, Dual Mono or None.

For subwoofer **Low Pass Filter Slope** you will be able to choose 24 dB/octave or 12 dB/octave.

And, if your Front speakers are set to Large, you will be able to enable or disable **Enhanced Bass**.

Note: A 5.1 channel surround system will have Surrounds, but NOT Back speakers. If you have configured Surrounds as None, then Back speakers must also be set to None. Even if you ONLY have two surround speakers, and they are located in the rear of the room, they should always be configured as Surrounds. The XMC-1 will NOT allow you to configure Back speakers if you have set Surrounds to None.

Levels

The Levels screen allows you to adjust the relative level of each speaker by up to +/- 12 dB in 0.5 dB increments, and provides a pink noise test tone to help you perform SPL measurements.

The test tone can be set to three different levels (Low - 65 dB, Medium - 75 dB, and High - 85 dB), or can be disabled if you prefer to use your own test signal source.

Note: The actual sound level at which the test tones will play in your listening room will depend on the gain of your amplifiers and the efficiency of your speakers. The SPL values shown for the different test signal output levels are estimates based on typical amplifier gain and speaker efficiency; always select the setting that produces the appropriate level with your equipment.

The XMC-1 Menu System

Setup | Speakers | EQ

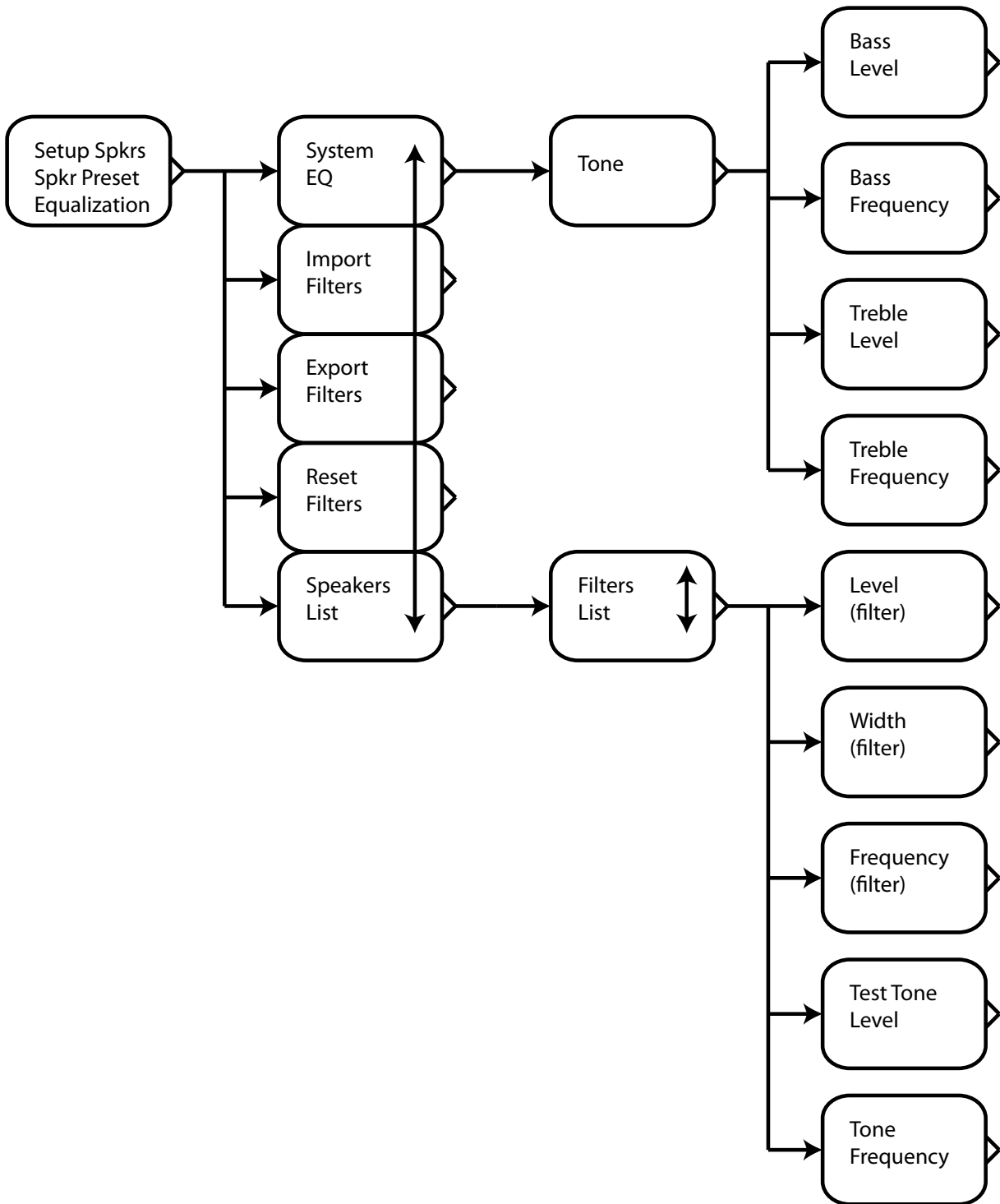

The XMC-1 Menu System

Once you have set the basic parameters for each preset (Speaker Size, Crossover Points, and Level Trims), you can use the XMC-1's powerful Parametric EQ filters and convenient Tone Controls to customize the sound just the way you want. Both the Tone Controls and the Parametric EQ filters may be used at the same time, giving you the precision and flexibility of Parametric EQ for detailed adjustments combined with the convenient sweeping tonal corrections offered by Tone Controls.

System EQ | Tone Presets (Tone Controls)

Note: The Tone Presets apply to all speakers (in the Preset you are currently configuring). Each Speaker Preset has its own independent set of Tone Presets.

Bass Level & Frequency Controls

The Bass Level Control is used to alter the relative level of the bass for all speakers by up to +/- 12 dB in 0.5 dB steps.

The Bass Frequency Control allows you to configure the turnover frequency for the Bass Level Control to any frequency between 40 Hz and 400 Hz.

Treble Level & Frequency Controls

The Treble Level Control is used to alter the relative level of the treble for all speakers by up to +/- 12 dB in 0.5 dB steps.

The Treble Frequency Control allows you to configure the turnover frequency for the Treble Level Control to any frequency between 500 Hz and 10 kHz.

Parametric EQ Filters

Note: There are 11 independent bands of full parametric equalization for EACH speaker in EACH of the two presets.

Note: If you're not familiar with using a parametric equalizer, you should understand that EACH band in a parametric equalizer can be configured to affect a wider or narrower range of frequencies. Even though the XMC-1 provides 11 bands of PEQ for each speaker, because of the combination of power and flexibility you get with parametric controls, you may only need to use one or two bands to make the required adjustments in a given situation. In fact, for various technical reasons, it's actually better to use the fewest bands you can to produce the necessary result.

The Test Tone Generator used to adjust the parametric equalizers generates a pure sine wave at a single configurable frequency.

Note: The actual sound level at which the test tones will play in your listening room will depend on the gain of your amplifiers and the efficiency of your speakers. The SPL values shown for the different test signal output levels are estimates based on typical amplifier gain and speaker efficiency; always select the setting that produces the appropriate level with your equipment.

The XMC-1 Menu System

The behavior of the controls used to adjust the parameters for the parametric equalizers in the XMC-1 has been meticulously optimized to make the process of making so many adjustments as simple and straightforward as possible. As a result, certain displayed fields will be synchronized even though they may be independently configurable. Others may display the same information in multiple locations to make the process of adjusting them easier.

It may take you a little while to get used to the way the controls work but, once you practice a little bit, we're sure you'll find them efficient, convenient, and, most important of all, not confusing.

- You may, of course, adjust all of the filter bands for one speaker, then move on to the next speaker. However, if you prefer to adjust a specific band for all speakers, then move on to adjust the next band for all speakers, the XMC-1 facilitates this by remaining set to the particular EQ band number you're working on when you switch between speakers. For example, if you're adjusting Filter 3 for your Front Right speaker, and you then switch to the Front Left speaker, you will be taken directly to the settings for Filter 3 for the Front Left speaker; this way you can very easily adjust each Filter band sequentially for all your speakers.
- Test Tone Level and Test Tone Frequency settings are global; even though the controls for the Test Tone Generator appear on several different menu screens, there is only a single Test Tone Generator which you are accessing from different places. Therefore, as you move from place to place in the menu system where the Test Tone Generator is used, the Test Tone Generator will remain set at the last Level and Frequency you select until you change it. When you exit the area of the menu where the Test Tone Generator is used, it will automatically switch Off.

Filter Level

For each filter, you can set the level from -64 dB to +6 dB in 0.5 dB increments.

Note: While it is not uncommon to have some overlap between EQ filters, or to have a narrow notch that falls inside a wider filter band where gain is applied, you should be careful about applying positive gain on overlapping filters; and avoid deliberately stacking multiple filters to create gain in excess of +6 dB. Although unlikely, it is possible, by applying excessive gain to overlapping bands, to cause the XMC-1 to clip.

Filter Width

For each filter, you can set the band width to cover anywhere from a fraction of an octave to several octaves. As you change the Filter Width setting, the width you set will be displayed as a traditional "Q" value, and as an actual range between the edges of the band. The edges of the band are defined as the points where the filter is at 50% of its maximum effect - expressed in dB. (For example, if a band is set to provide -20 dB of gain, then edges of that band are defined as the -10 dB points.)

Note: You can adjust the width of each filter by changing the value in either the Q field or the field that shows the width of the band in Hz. However, while you are changing the value, only the number in the field you are using will change dynamically; the value in the other field will synchronize as soon as you exit the active field.

The XMC-1 Menu System

Filter Frequency

For each filter, you can set the center frequency of the band to any frequency between 20 Hz and 20 kHz, and the result will be displayed in Hz (or kHz).

Test Tone Level

The Test Tone Generator on the XMC-1 offers both pink noise and sine wave test tones at various frequencies for use in calibrating the parametric EQs. For each type of test tone you may select three different output levels: High -85 dB, Medium - 75 dB, Low - 65 dB, and Off for use with external calibration signal sources.

Note: The actual sound pressure level your system will produce at each different output level setting will depend on many factors, including the gain of your amplifiers and the efficiency of your speakers. The “dBspl” settings shown for each level choice are therefore only approximations of the sound level that may be produced - based on the characteristics of a “typical system”. Always use common sense and select reasonable sound pressure levels at which to perform tests based on the results of your measurements.

There is only a single Tone Generator, even though the control appears in duplicate under the options for each filter.

If you select Off (External) as your test signal source, then whatever input source is currently selected on the XMC-1 will be used as the test tone source. This input will be treated as if it were playing in the equivalent of All Stereo Mode, but the resulting output signal will then be sent to *ONLY* the currently selected channel.

Test Tone Frequency

If you have selected sine wave test tones using Test Tone Level, then you can use the Test Tone Frequency control to set the output frequency of the sine wave test tone. There is only a single Tone Generator, even though the control appears in duplicate under the options for each filter. The Test Tone Generator output frequency can be set to any frequency between 20 Hz and 20 kHz, and the result will be displayed in Hz (or kHz).

Note: You may notice that the test tones are not absolutely pure continuous sine waves - and may include audible ticking noises at certain frequencies. While audible, these noises are simply artifacts of the program code used to generate the test tones; they do NOT significantly affect the energy distribution of the test tones, and have no significant effect on measurements performed using the test tones.

The XMC-1 Menu System

Import Filters

This option allows you to import sets of parametric EQ settings that you have previously saved, and to import correction filter settings exported by Room EQ Wizard or other third-party programs. Filter settings are stored in a set of XML files - one file for each channel, which are stored on a USB thumb drive, in a folder whose name corresponds to the Speaker Preset. When you Import Filters, all XML files in the appropriate preset folder on the USB thumb drive will be read, and the settings in each file present will replace the current settings for that Speaker Preset in your XMC-1. If only files corresponding to some channels are present, settings for those channels will be updated, and all other channels will remain unchanged.

See the Appendix entitled Importing and Exporting Parametric EQ Filters for more details, and for specific information about importing settings from Room EQ Wizard.

Export Filters

This option allows you to export the parametric EQ settings for the current Speaker Preset to a USB thumb drive as a set of XML files (these will be standard XML files with a .EMO extension).

See the Appendix entitled Importing and Exporting Parametric EQ Filters for more details.

Reset Filters

This option allows you to reset all the parametric EQ settings in the current Speaker Preset to their default values (flat).

The XMC-1 Menu System

Setup | Inputs Menu

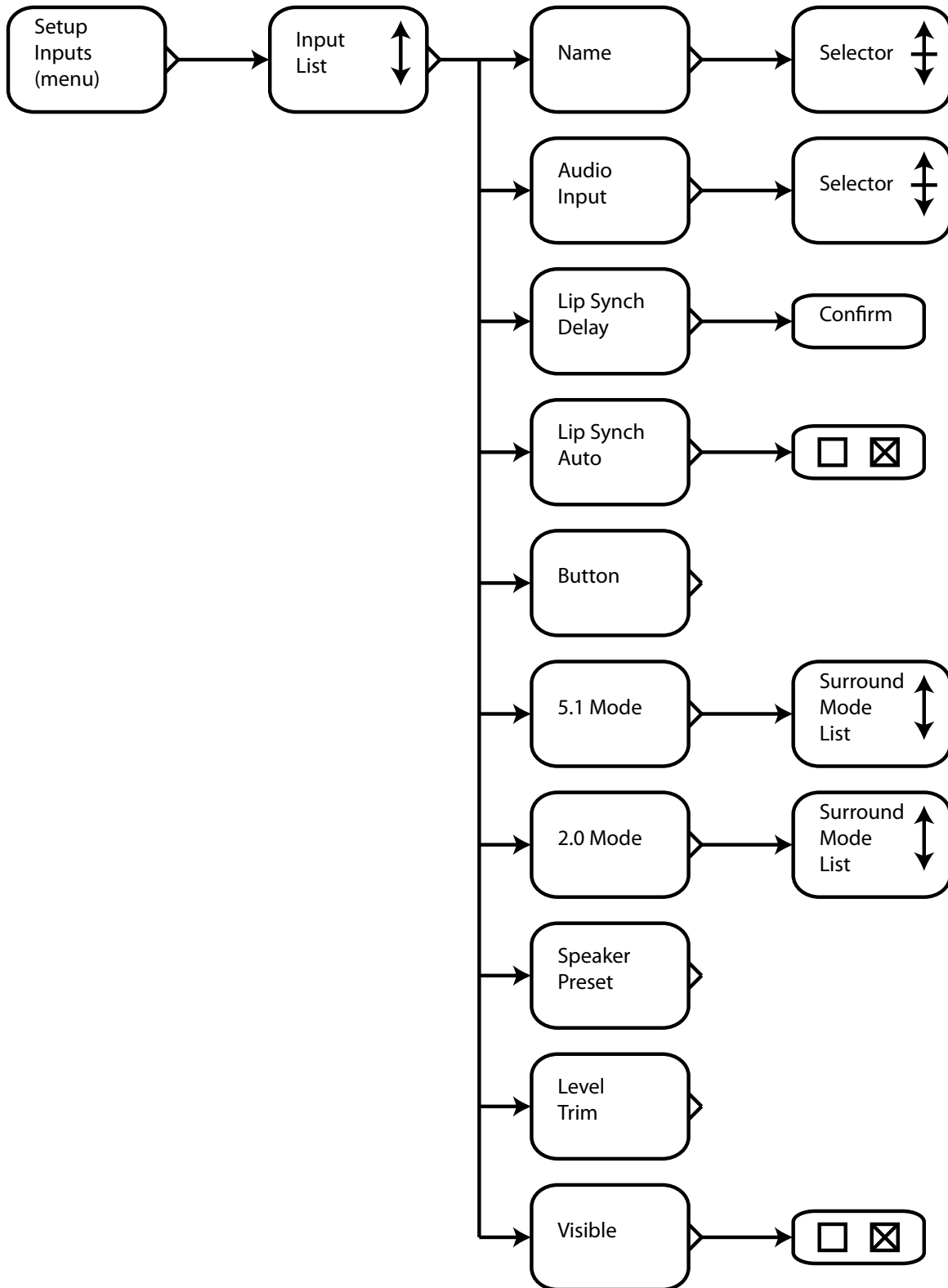

The XMC-1 Menu System

The **Setup Inputs Menu** allows you to independently set a Level Trim and various other parameters for each Input, and determine how that particular Input will handle each of several different types of input signals.

Note: Remember that the Input settings are independent for each Input, and so must be configured individually for each Input you use.

After selecting Setup Inputs you will be asked to select which Input you wish to configure. ALL of the following settings are available for EACH Input, and may be configured independently for each.

Note: When you enter the Setup Inputs Menu, the Input you are configuring will become the active Input and the XMC-1 will switch to it.

Name

The Name field allows you to configure an alphanumeric “human friendly” name for each Input.

Audio Input

By default, when an HDMI Input is selected, both audio and video signal are taken from that Input. This setting allows you to choose a different audio Input to be used with each HDMI Input.

Note: Normally, when using an HDMI Input, using that same Input for both your audio and video signal is preferred. However, there are two situations where that may not be true. Sometimes specific hardware compatibility issues may be avoided by choosing a non-standard audio Input. For example, if your cable box has issues with the audio it sends over its HDMI outputs, you may use this setting to tell the XMC-1 to take audio for that Input from a Coax digital or Toslink connection instead. Another possibility is that you may simply prefer to use a certain output - other than HDMI audio - with certain equipment. For example, if you have a Blu-Ray player with high-quality DACs, you may wish to allow it to decode and play the audio when you play discs on it. If so, then you would connect the analog outputs of your player to one of the analog inputs on the XMC-1, and use this setting to configure your XMC-1 to use audio from those analog Inputs with the video signal it receives via that HDMI Input.

Note: Because it concerns which audio signal is associated with a given video input signal, the Audio Input configuration option is ONLY available for HDMI Inputs.

Lip Synch Auto

With most equipment, an HDMI connection includes the ability to automatically negotiate and set the correct Lip Synch Delay in most situations. Enable Lip Synch Auto to allow the XMC-1 to set the Lip Synch Delay automatically.

The XMC-1 Menu System

Lip Synch Delay

The Lip Synch Delay setting is used to manually configure the Lip Synch Delay.

Note: The optimum Lip Synch Delay can vary with different program material from different sources; the automatic configuration is designed to compensate for this, and so is usually the best option. The Lip Synch Delay is normally only configured manually if the automatic configuration fails to work properly with certain source equipment and/or a certain display or projector.

Note: Setting Lip Synch Auto overrides the ability to set a Lip Synch Delay manually; if Lip Synch Auto is checked, you will NOT be able to enter a value in the Lip Synch Delay field.

Button

The Button setting allows you to configure a direct access button for this Input (on the front panel and the remote control).

None assigns no button to the Input.

1 - 8 assigns that button on both the front panel and the remote control to that Input. (Only buttons 1 through 7 exist on the remote control; button 8 exists only on the front panel.)

Note: You may wish to assign button 8 to an Input that you only use “locally”, such as a Reference CD player located in your equipment rack, or the front panel analog input.

5.1 Mode

The **5.1 Mode** setting determines what mode will be used by default when a surround sound signal is received at this Input. You will be offered a list of valid modes to choose from. Selecting **Auto**, which is the default, will instruct the XMC-1 to select the best mode for each particular type of signal received. Selecting **Last Used** will instruct the XMC-1 to use whatever mode was used the last time a similar input signal was received on the same Input; in this mode, if you manually override the XMC-1's default choice, your manual choice will become the default for the next time a similar signal is received.

Note: Selecting Surround as the 5.1 Mode will instruct the XMC-1 to play discrete 5.1 or 7.1 channel content (multi-channel PCM for example) with no decoding or modification. Selecting +Dolby PLIIx or +DTS ES Matrix will instruct the XMC-1 to use post processing if necessary to synthesize 7.1 channels from 5.1 channel content by creating rear surround channels. (In this process, the front channel signals remain unchanged, but content from the surround channels is processed to create surround channels and rear surround channels.)

2.0 Mode

The **2.0 Mode** setting determines what mode will be used by default when a two channel signal is received at this Input. You will be offered a list of valid modes to choose from. Selecting **Auto**, which is the default, will instruct the XMC-1 to select the best mode for each particular type of signal received.

The XMC-1 Menu System

Speaker Preset

For each Input, you may select to apply any of the three separate speaker/room preset equalization curves provided by the XMC-1.

The **Dirac** preset is provided by the Dirac Live automatic room correction system; this curve is created when the Dirac software is run.

The other two presets (which will be named whatever name you assign to them when you create them) are created manually using the XMC-1's advanced parametric equalizer banks and controls. (See the Setup |Speakers and Setup | Speakers EQ sections for details.)

Level Trim

The Level Trim setting allows you to individually adjust the audio level for each Input. This is typically used to adjust the levels of each input to be similar. The Level Trim can be adjusted to anywhere between +/- 10 dB in 0.5 dB increments.

Visible

The **Visible** setting allows you to configure whether each Input appears when you scroll through the list of available Inputs. By setting Inputs you don't use to NOT Visible, you won't have to scroll past them when selecting an Input.

Note: The Visible setting only affects whether an Input will be skipped over when you switch Inputs using the Input Up and Input Down buttons. Even if you set an Input to Not Visible, you will still be able to access it using a button that you have assigned directly to it.

Connecting the XMC-1

Connecting the XMC-1

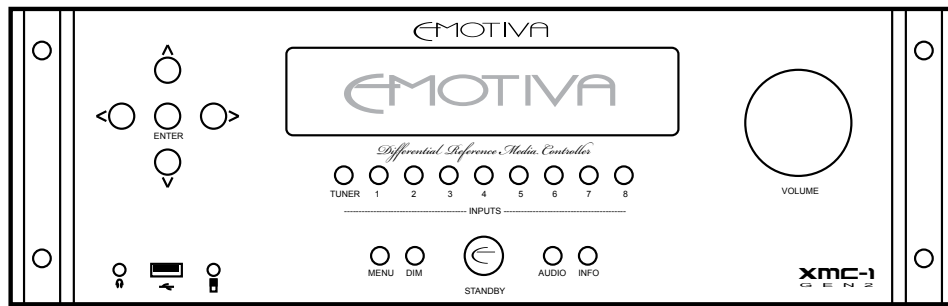

Connecting the XMC-1

XMC-1 Front Panel

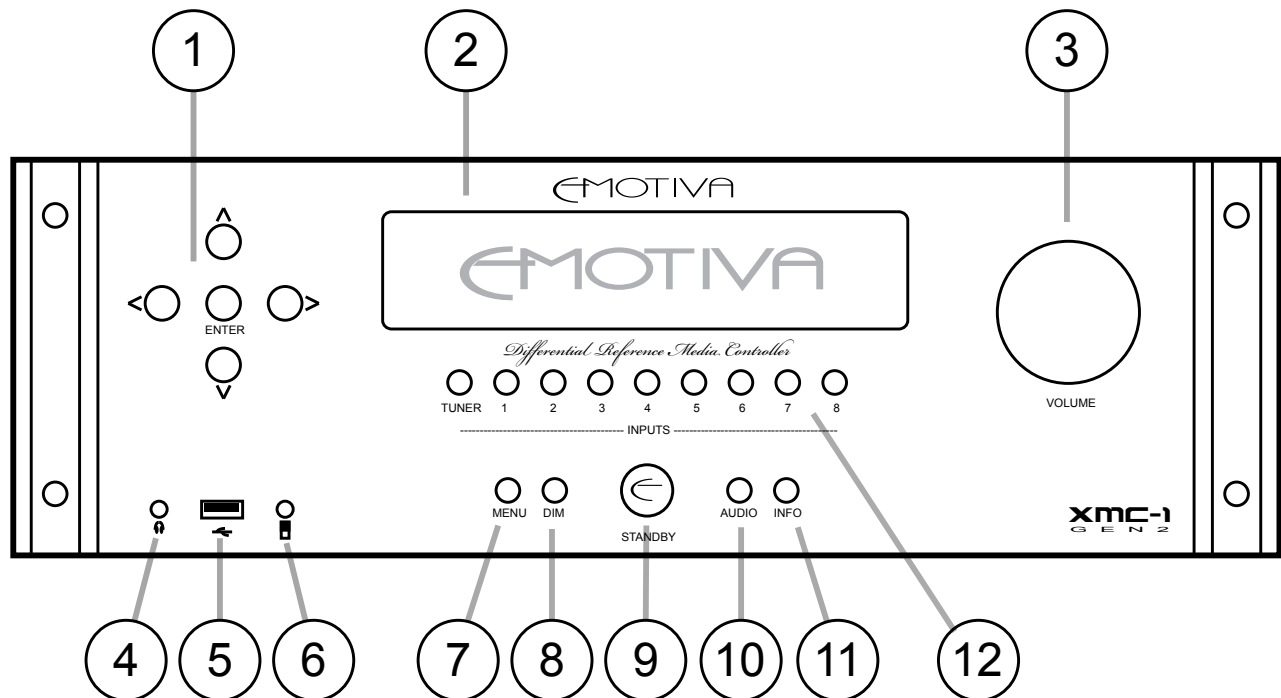

1. Navigation Buttons (Left, Right, Enter, Up, Down)

When the menu system is not active, the Up and Down buttons are used to select the active input. When the configuration menu is active, these buttons are used to navigate the menu.

2. Front Panel Status Display

Large, bright, easy to read graphical 256 x 60 pixel OLED status display.

3. Volume Control

The Volume Control on the XMC-1 is a rotary encoder that instructs the digitally controlled analog resistor ladder network volume control.

Press the Volume Control in until it clicks to mute the outputs; press the knob a second time to unmute the outputs; both main and headphone outputs will be muted (but *NOT* the Zone 2 outputs).

4. Headphone Jack

Connect any standard pair of stereo headphones for high-quality personal listening. When you plug in a pair of headphones, the main outputs are automatically muted.

5. Front Panel USB Input

This input is used to apply firmware updates to the XMC-1 via a standard USB stick (thumb drive).

Connecting the XMC-1

6. Front Panel Analog Input

Connect any music source that supplies line level stereo analog audio to this input. This input is named "Analog Front", and is typically used for an iPod or other portable music player.

7. Menu Button

Press the Menu button to activate the configuration menu; press the Menu button again to return to the Information display. When the Menu is active on the XMC-1 front panel, the Menu will also be displayed on the On-Screen Display (OSD).

8. Dim Button

Press the Dim button once to display the current Brightness setting. Once the Brightness setting is displayed, press the button repeatedly to adjust the Brightness setting of the XMC-1 front panel display. When this button is pressed, the current setting is displayed; each subsequent press advances the Brightness one level; if the Brightness is at 100%, the next button press returns it to 0%. (Brightness can be adjusted in six steps: 0%, 20%, 40%, 60%, 80%, 100%).

Note: When Brightness is set to 0%, the front panel display will be completely off during normal operation, but will momentarily switch to the minimum visible setting whenever any control is operated.

9. Standby Button

Press this to switch the XMC-1 from Standby to On; press it again to return the XMC-1 to Standby mode. (The rear panel AC Power switch must be On.) The halo ring around the Standby button illuminates amber for Standby and blue for On.

Note: In its default configuration, when the XMC-1 is powered on using the rear panel Power switch, the halo ring around the Standby button will immediately illuminate blue. A few seconds later, the Emotiva logo will appear in the display, and a progress bar will move across the bottom of the display to indicate that the XMC-1 is booting up; the boot-up process will take about a minute. When the boot-up process is complete, the halo ring around the Standby button will switch to amber, indicating that the XMC-1 is then in Standby mode. Pressing the Standby button at this point will switch the XMC-1 to On. (Loading the operating software and completing the boot-up process when first powered on and entering Standby mode enables the XMC-1 to switch very quickly between Standby and On afterwards.) When the XMC-1 is configured to Video On Standby mode, the operating software remains loaded as long as the XMC-1 is powered on, and startup takes only a few seconds. Refer to the sections entitled XMC-1 Start Up Routine and Video On Standby for more details.

10. Audio Button

Press this button to cycle through the valid surround sound decoding modes available for the input that is currently selected. (The modes you can choose from will depend on the signal being received at the input.)

Connecting the XMC-1

Note: When playing DVD and Blu-Ray discs, your player and the disc itself will probably offer you a choice of several audio modes. After you select one, the XMC-1 will determine which type of audio is being supplied by your source component, and will ONLY allow you to choose audio modes that are compatible with that input signal. (For example, if you select "Dolby Digital" when playing a disc, the XMC-1 will offer you digital surround options compatible with that mode, but NOT modes which are not compatible with it.)

11. Info Button

Press this button to cause the information from the XMC-1 front panel display to show momentarily on the OSD. (You can also use this button to momentarily "light" the front panel display if Brightness is set to 0%.)

12. Direct Input Selector Buttons

Each of these buttons can be used to immediately select a configured input.

Note: The Front Button lock in the Setup | Advanced Menu is intended to prevent settings on the XMC-1 from being inadvertently changed (and also acts as a "child lock"). If you accidentally become locked out of the XMC-1 by disabling all controls, you can override this feature and access the Setup Menu by HOLDING THE ENTER BUTTON DOWN WHILE PRESSING THE MENU BUTTON (both on the front panel).

Note: By certain combinations of settings, it is possible to end up in a situation where you must press the Standby button to turn your XMC-1 On, but both the front panel buttons and the remote control have been disabled. If this happens, you may override the lock on the front panel controls and turn your XMC-1 On by HOLDING THE ENTER BUTTON DOWN WHILE PRESSING THE STANDBY BUTTON (both on the front panel).

Connecting the XMC-1

XMC-1 Rear Panel

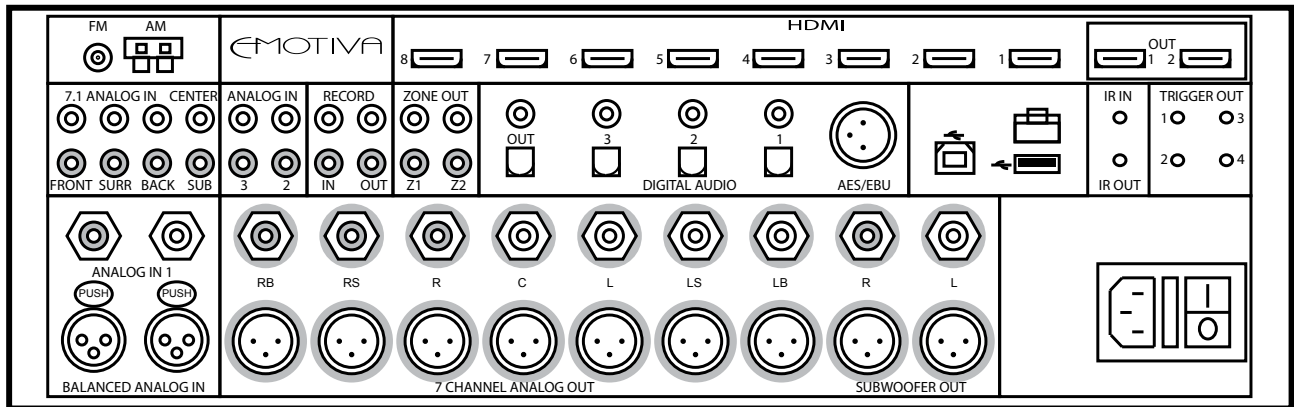
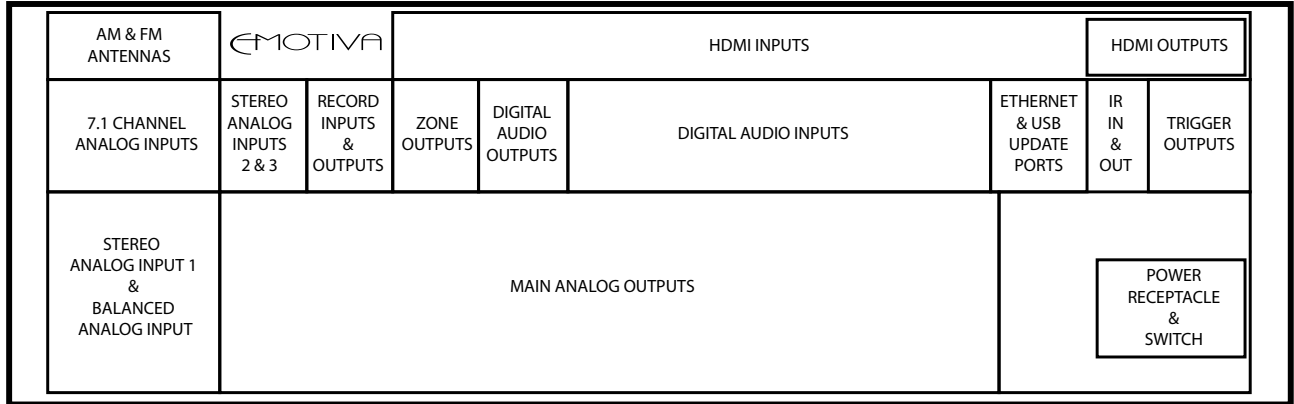

Connecting the XMC-1

Rear Panel - Video Inputs and Outputs (HDMI)

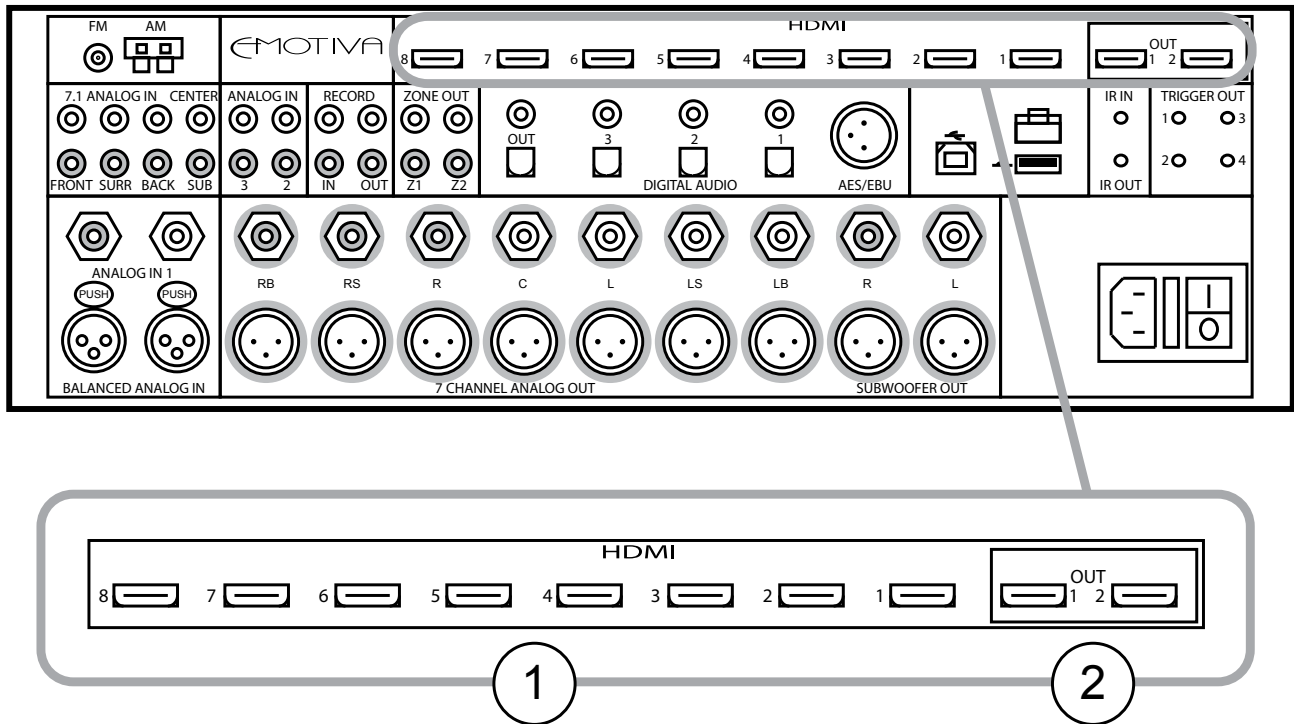

1. HDMI Inputs (8)

Provide eight inputs for components that have either HDMI or DVI-D outputs. (An appropriate adapter will be required to connect DVI-D devices, and not all features will be available.) All eight HDMI inputs are identical, and are HDMI 1.4b .

2. HDMI Outputs (2)

Each HDMI output is HDMI 1.4b compliant, HDMI Out 1 is ARC and CEC enabled.

Connecting the XMC-1

Rear Panel - Analog Audio Inputs

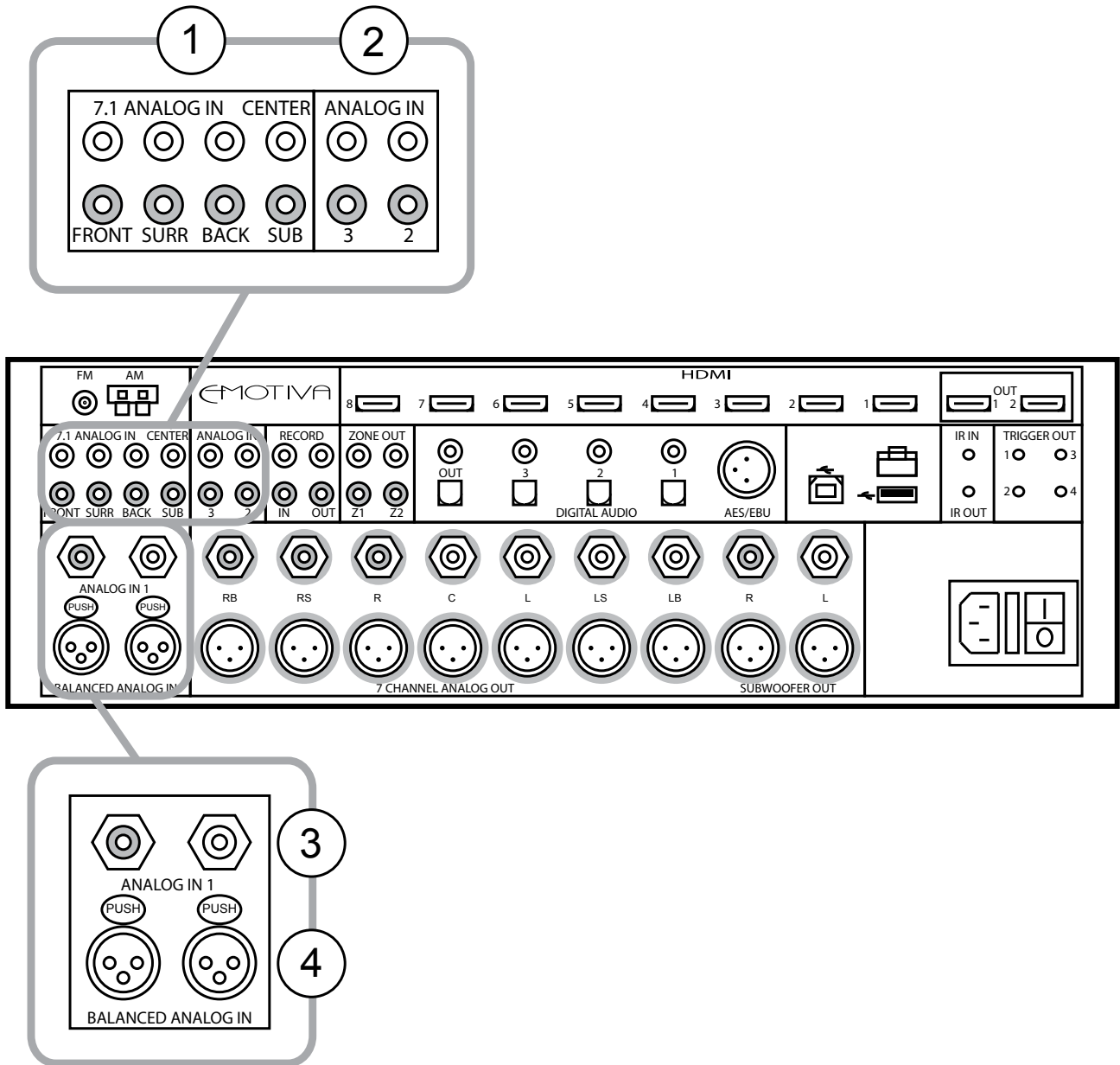

1. 7.1 Unbalanced Analog Audio Inputs (1 set)

Provides one set of unbalanced 7.1 channel surround audio inputs. The signals received at these inputs bypass all digital processing and are passed directly to the volume control and the preamp outputs. Typically, the analog surround sound outputs of an SACD player or external decoder are connected to these inputs.

Connecting the XMC-1

2. & 3. Stereo Unbalanced Analog Audio Inputs (3 pairs)

Provide inputs for three unbalanced stereo analog sources.

4. Stereo Balanced Analog Audio Inputs (1 pair)

Provides an input for one balanced analog source.

Note: The Balanced Analog Input is independent from Analog In 1 (they may be used and configured separately).

Connecting the XMC-1

Rear Panel - Main Analog Audio Output

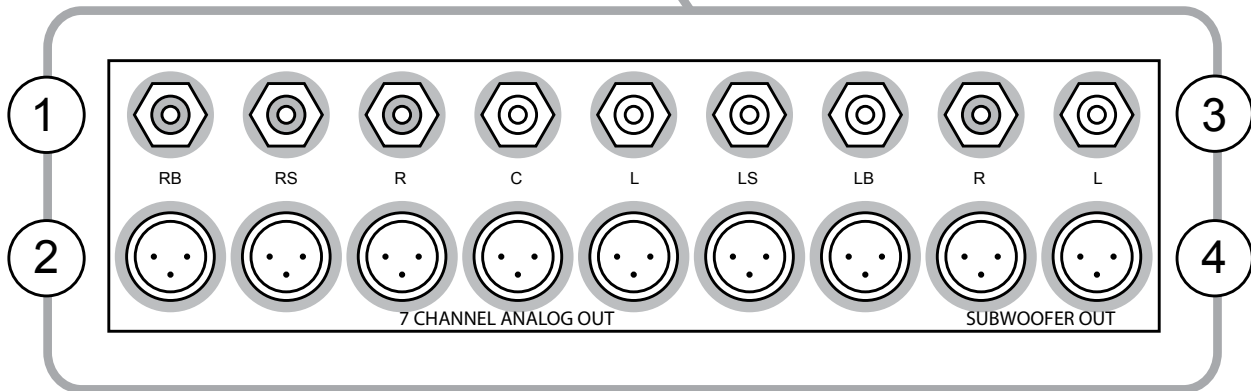
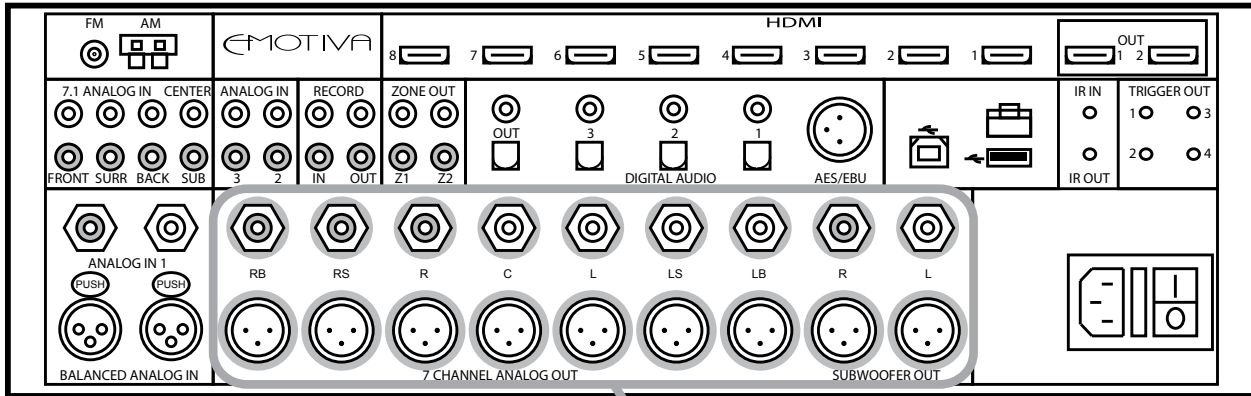

1. 7.2 Channel Main Outputs (unbalanced)

Connect these line level outputs to an external power amplifier.

2. 7.2 Channel Main Outputs (balanced)

Connect these line level outputs to an external power amplifier.

Note: When both options are available, balanced connections are preferred because they are more robust and less sensitive to noise. If your other components are fully differential, you must use balanced connections between them and the XMC-1 to maintain a fully differential system topology.

3. Stereo Subwoofer Outputs (unbalanced)

Connect these line level outputs to a pair of external powered subwoofers.

Connecting the XMC-1

4. Stereo Subwoofer Outputs (balanced)

Connect these line level outputs to a pair of external powered subwoofers.

Note: If you have two subwoofers, you may choose to configure them as Stereo, or as Dual Mono. If you choose Stereo, both subwoofers will remain separate, and your XMC-1 will be operating in 7.2 channel mode. If you choose Dual Mono, both subwoofers will be configured and adjusted separately, but both will then receive the same summed audio signal. If you choose one Mono subwoofer, then it should be connected to one of the Left Subwoofer outputs.

Note: Both balanced and unbalanced outputs are active at all times.

Connecting the XMC-1

Rear Panel - Record Input and Output

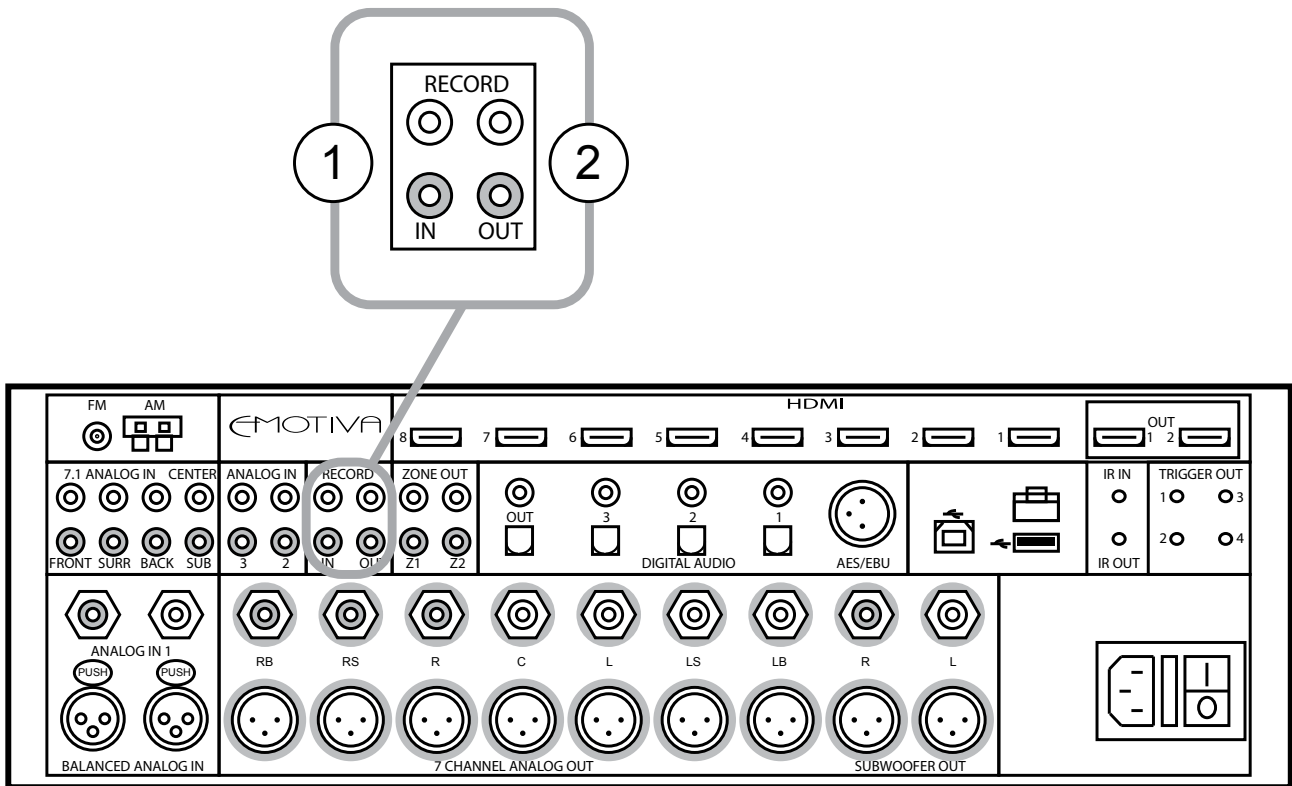

1. Record Output

Provides a stereo unbalanced analog output that is the stereo mixdown of the surround sound source currently playing in the main zone for connection to a stereo analog recording device (or the analog audio inputs of a VCR or DVR).

This output can also be used to connect a headphone amplifier that requires a fixed-level output because it has its own level control.

2. Record Input

Accepts a stereo unbalanced input from a stereo analog recording device (or the analog audio outputs of a VCR or DVR).

Connecting the XMC-1

Rear Panel - Zone Outputs

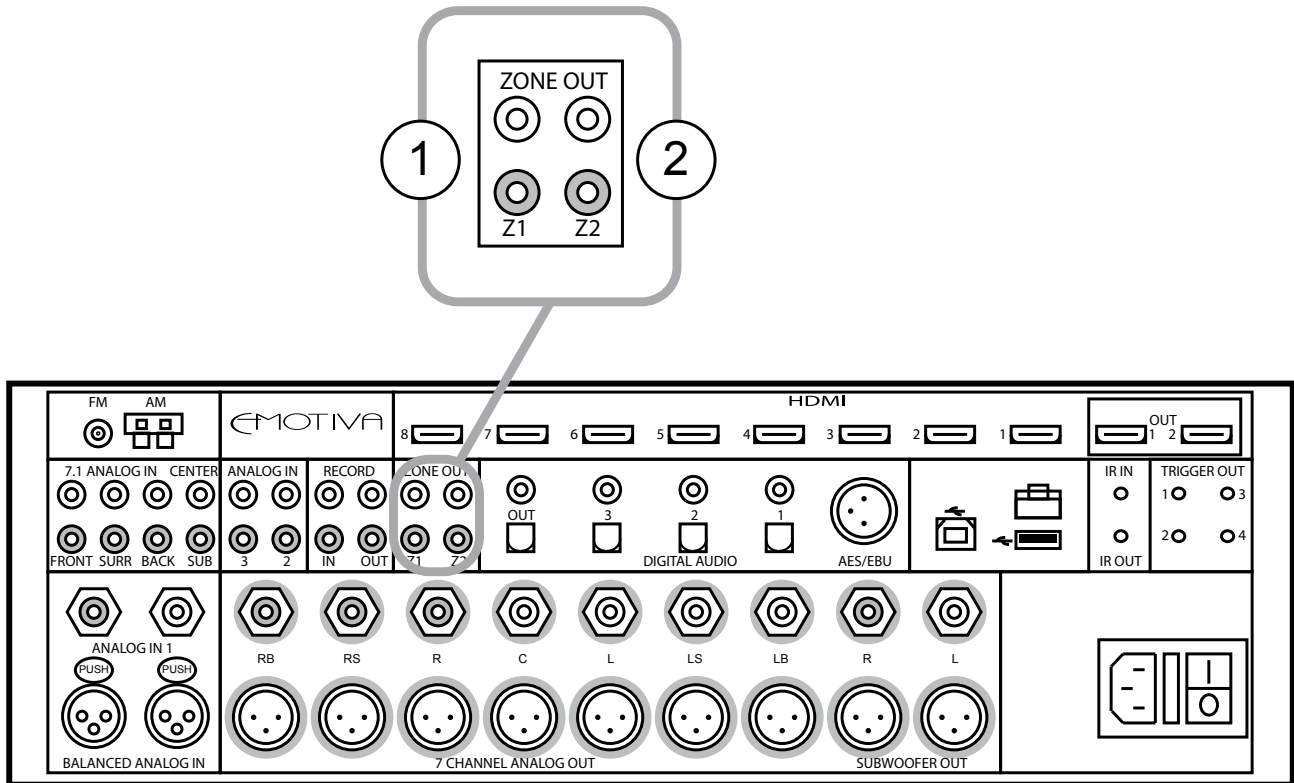

1. Zone 1 Audio Output

Provide a stereo unbalanced line level analog audio down-mix output for the Main Zone. The Volume setting on this output tracks with the Main Zone Volume setting.

2. Zone 2 Audio Output

Provide a stereo unbalanced line level analog audio output for Zone 2.

Note: The XMC-1 supports two audio zones, the Main Zone and Zone 2.

Note: On the XMC-1, the Zone 2 Input source may be selected independently from the Main Zone source. If you select Follow Main as your Input for Zone 2, then Zone 2 will play whatever is playing in the Main Zone - with no restrictions. If you prefer to have Zone 2 play content from a different source, you will be able to select ANALOG sources, and 2 CHANNEL PCM DIGITAL sources connected to Optical or Coax digital inputs. You will NOT be able to select a different digital surround sound or HDMI source for Zone 2 than what is selected for the Main Zone.

Connecting the XMC-1

Rear Panel - Digital Audio Inputs and Outputs

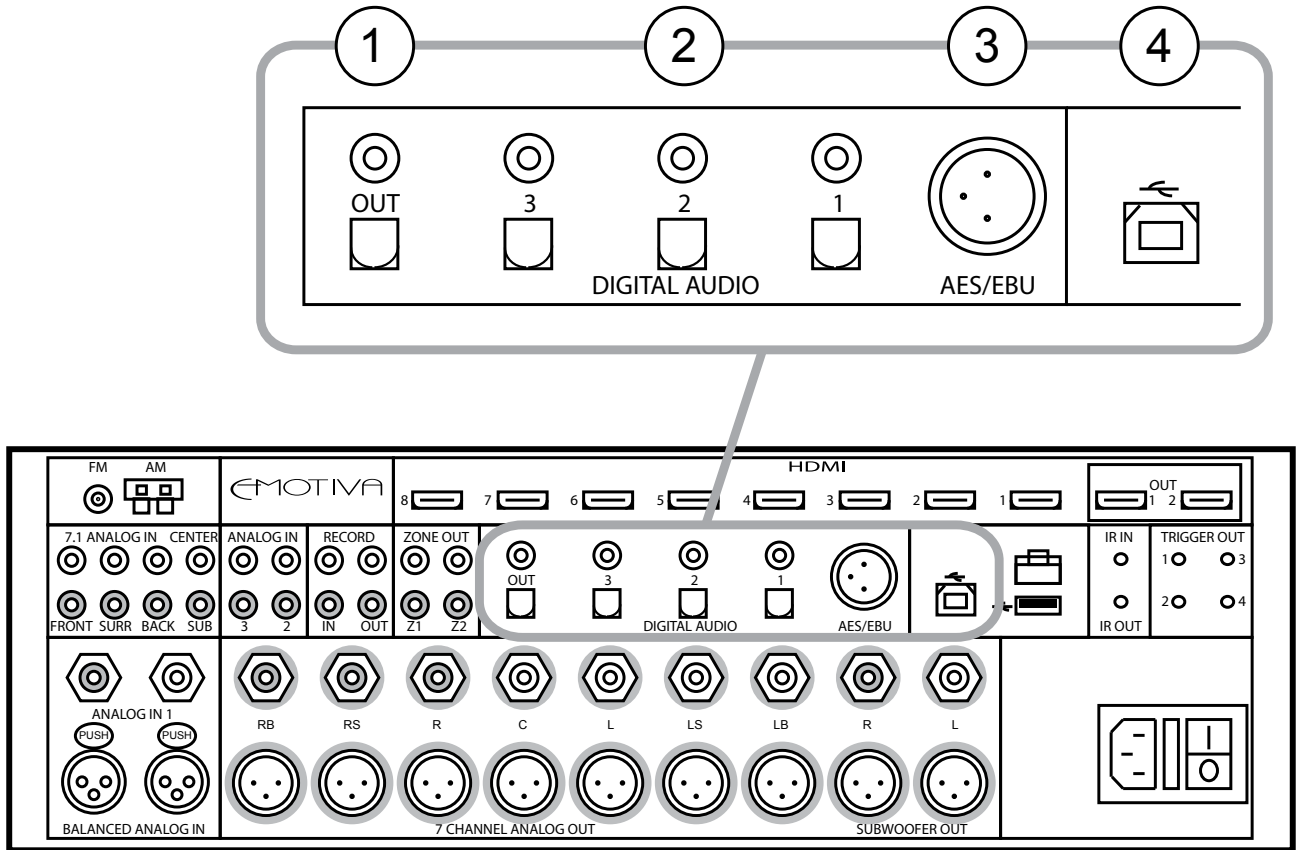

1. Digital Audio Outputs

Connect these outputs to the digital inputs of an external audio device or DAC.

Note: The Digital Audio Outputs of the XMC-1 are subject to processing, and/or re-sampling or sample rate conversion in some instances. They are intended for connecting other external devices with their own digital inputs, but should not be considered to be bit-perfect copies of the digital input signal.

2. & 3. Digital Audio Inputs

The XMC-1 provides seven digital audio inputs, designated Coaxial 1, Coaxial 2, Coaxial 3, Optical 1, Optical 2, Optical 3, and AES/EBU.

Connecting the XMC-1

4. USB Stream Input

Use this input to connect a computer or other compatible media client to the XMC-1.

The XMC-1 will appear as a USB audio device (sound card or speaker) to a computer that is connected to this input. This input supports all standard sample rates between 44.1k and 192k.

Note: This input requires a source device that supports USB Audio Class 2 (UAC2). To computers connected to this input, the XMC-1 will appear as an external USB audio device. Modern Apple computers support this directly (without any additional drivers); Windows computers will require you to load a driver on the computer (we provide the driver); other operating systems (like Linux) may or may not support this type of connection. You CANNOT connect a USB stick or USB hard drive to this input.

Connecting the XMC-1

Rear Panel - Ethernet and USB Update Ports

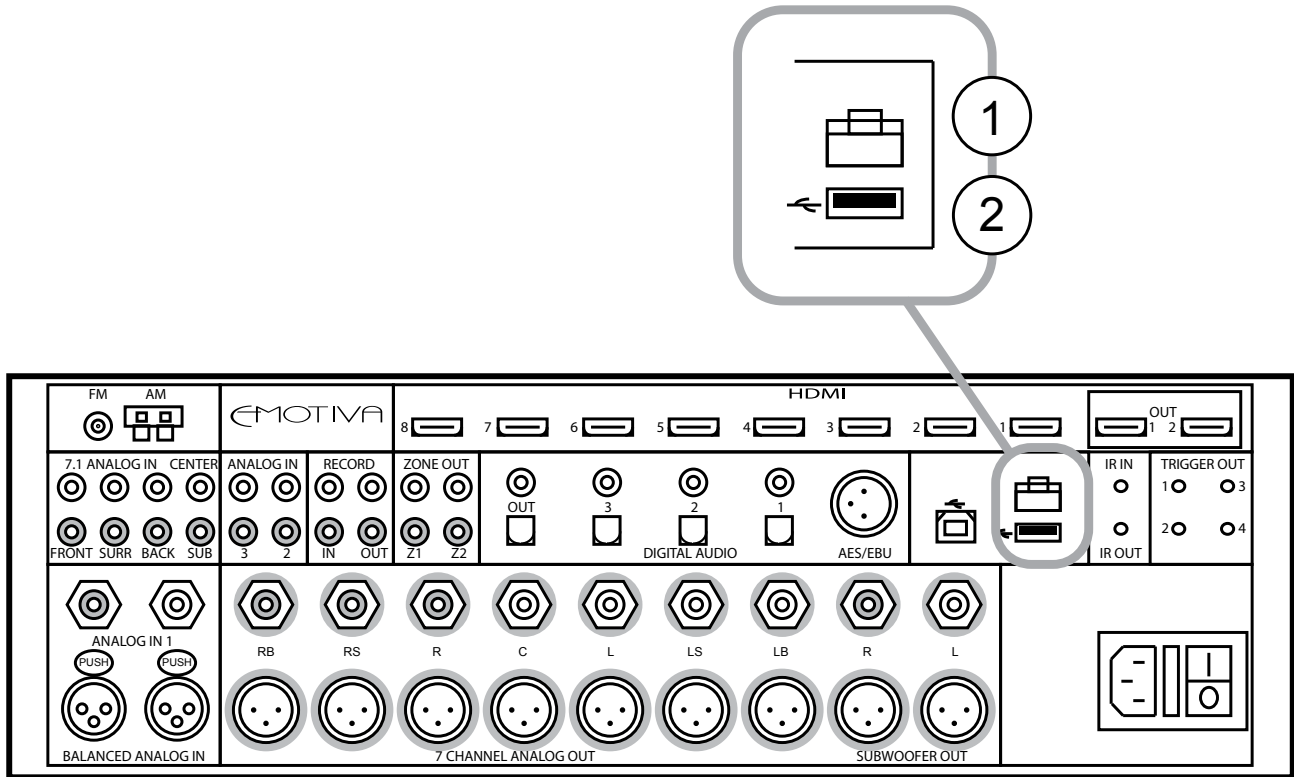

1. Ethernet Connection

The XMC-1's Ethernet connection is used to connect the XMC-1 to the Internet via your home network. A network connection is required in order to configure Dirac Live automatic room correction, and to allow Ethernet-based or Internet-based remote control apps to connect to the XMC-1 .

Note: A network connection with an Internet connection is required for configuring Dirac Live but, once Dirac is configured, the XMC-1 does NOT need to remain connected to the Internet - or to your local network - to operate.

Note: The XMC-1 currently does NOT have the ability to play audio or video sources via the Ethernet input.

2. Rear Panel USB Input

The front panel and rear panel USB data inputs are used to apply firmware updates to the XMC-1 via a standard USB stick (thumb drive).

Connecting the XMC-1

Rear Panel - Infrared (IR) Remote Input and Output

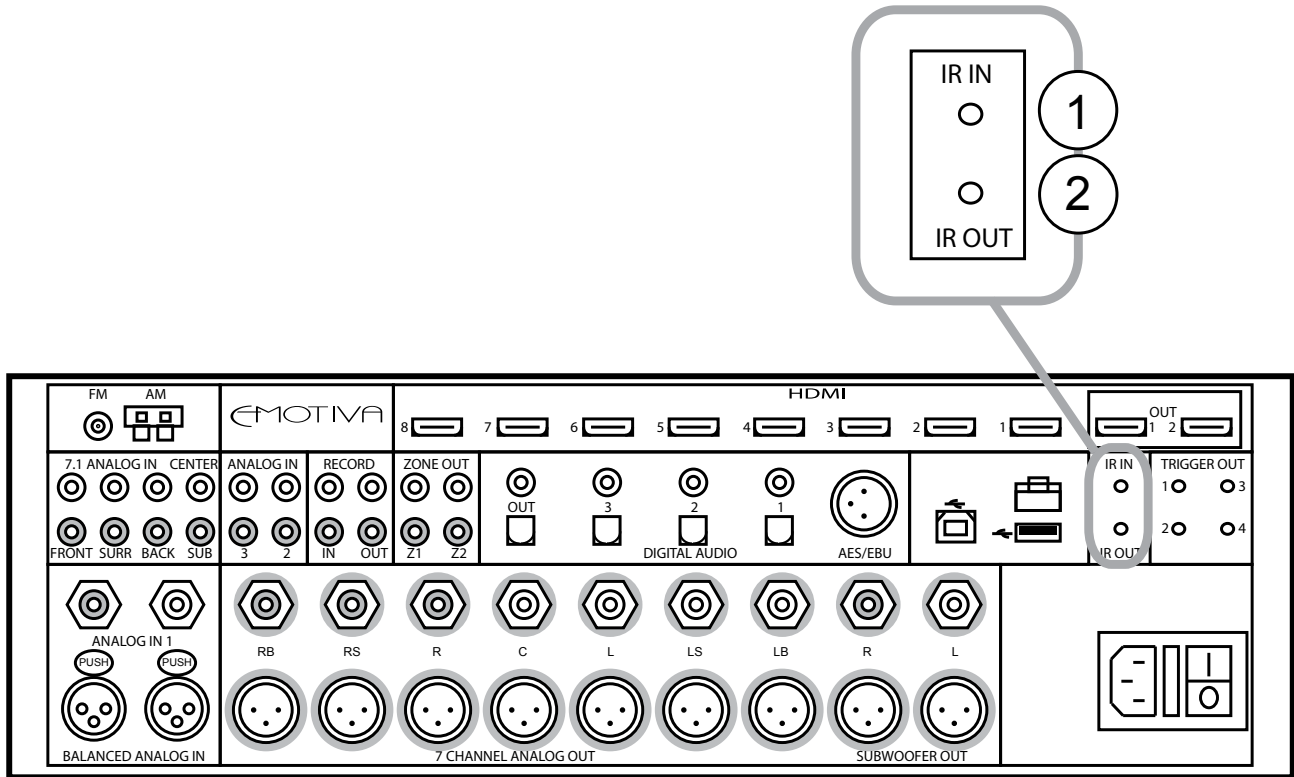

1. & 2. IR Remote Input and Output

Connect a remote IR detector (eye) to this input. This is especially useful if your XMC-1 is located in a cabinet or other area where the front panel IR detector is blocked. Connect a remote IR transmitter ("blaster") to this output to control other equipment.

Note: When the XMC-1 is On or in Standby, it always "listens" for IR remote control codes. If configured to do so, the XMC-1 can accept remote control codes intended for other devices via its front panel and remote IR inputs, and relay remote control codes intended for other devices via its IR remote control outputs. Because this capability is always active, the Standby button on the XMC-1 will flicker to indicate that it is receiving remote control codes when you operate IR remote controls for OTHER devices within range of its sensors; this is normal.

Connecting the XMC-1

Rear Panel - Trigger Outputs

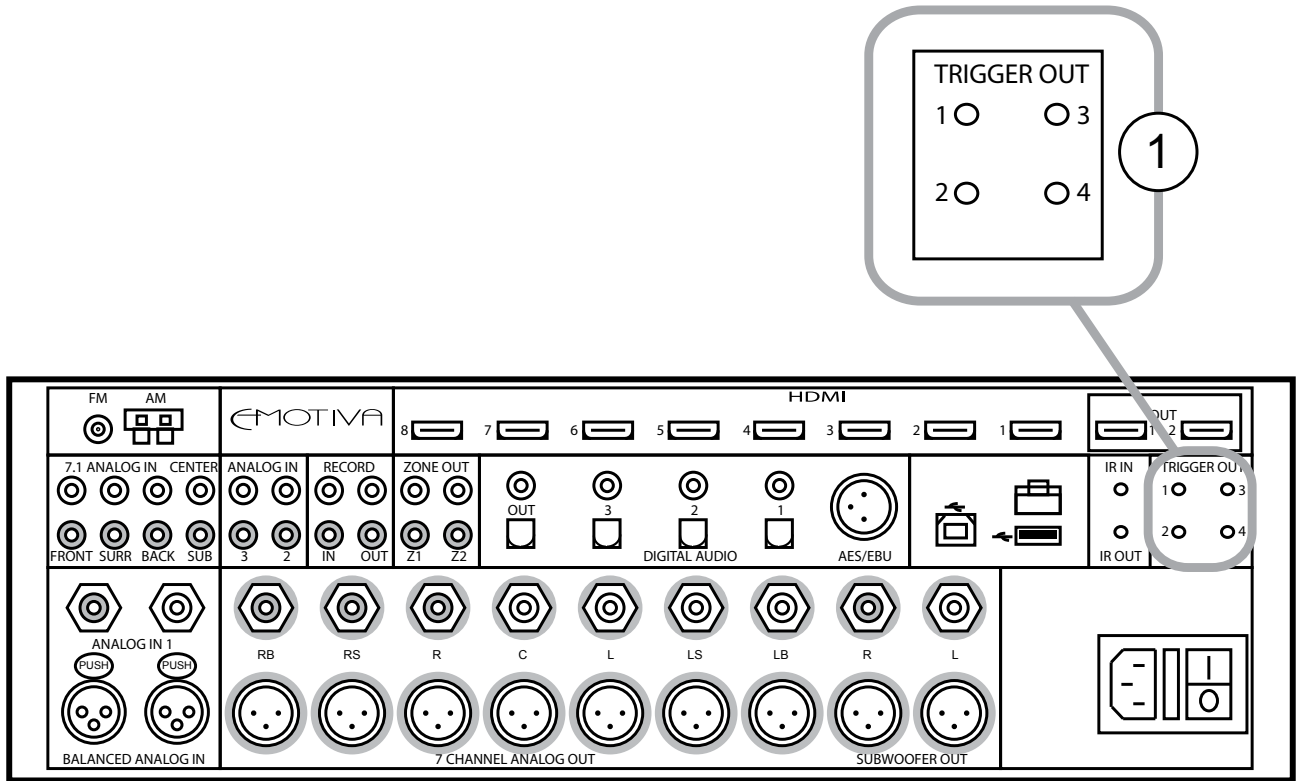

1. Trigger Outputs (4)

Connect each Trigger Output to one piece of trigger-enabled audio equipment. You can then configure the XMC-1 to turn on specific trigger-enabled equipment when specific input sources or modes are selected.

Connecting the XMC-1

Rear Panel - Power Switch, IEC Power Receptacle, and Fuse Holder

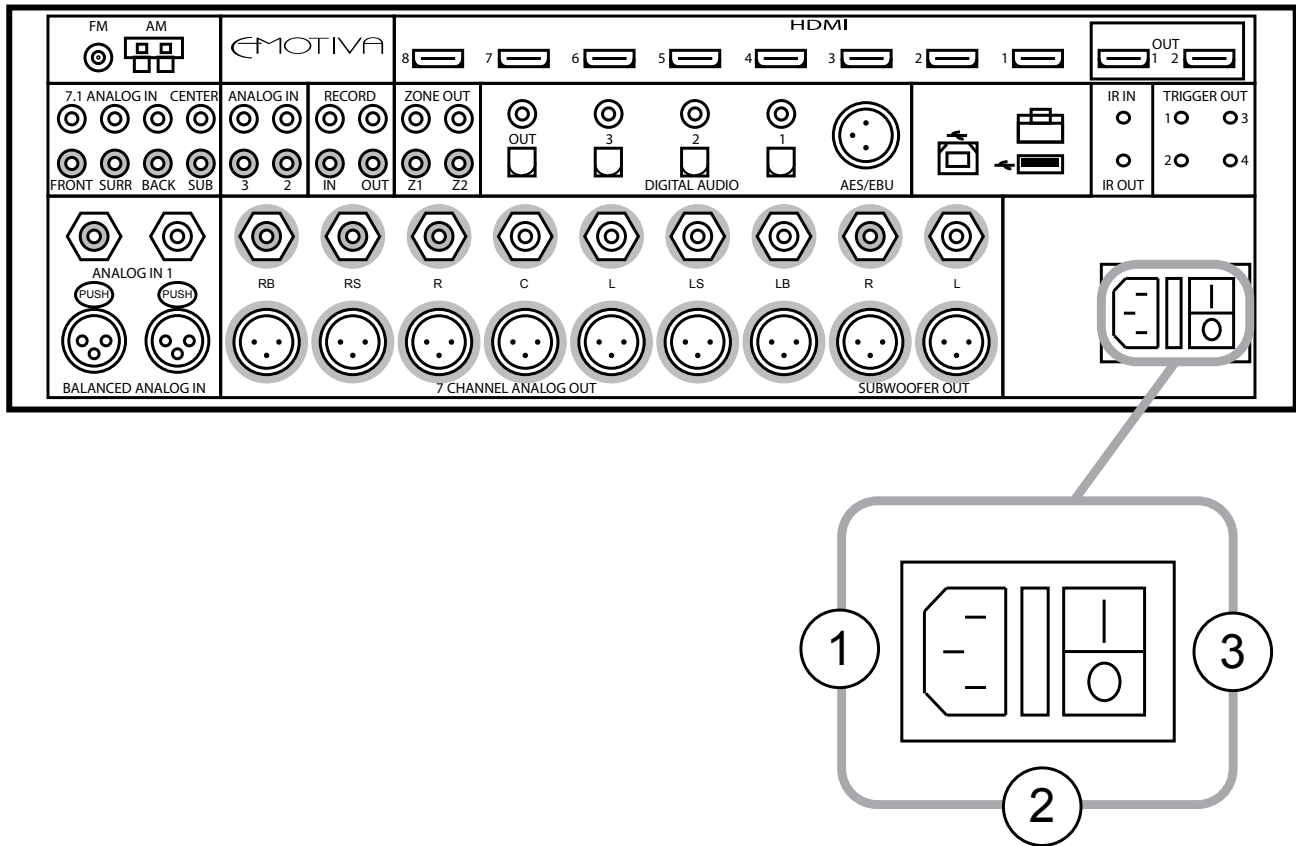

1. Standard IEC Power Inlet

The XMC-1 can be used with either a two-wire or three-wire standard IEC power cable.

2. Fuse Holder

This fuse holder holds the XMC-1's main system AC fuse. See the section entitled Fuses for details about how to check this fuse, and change it if necessary.

3. Power Switch

Switches the AC main power to the XMC-1 On and Off. When this switch is Off, the XMC-1 will not respond to trigger signals or manual controls.

Connecting the XMC-1

XMC-1 Remote Control

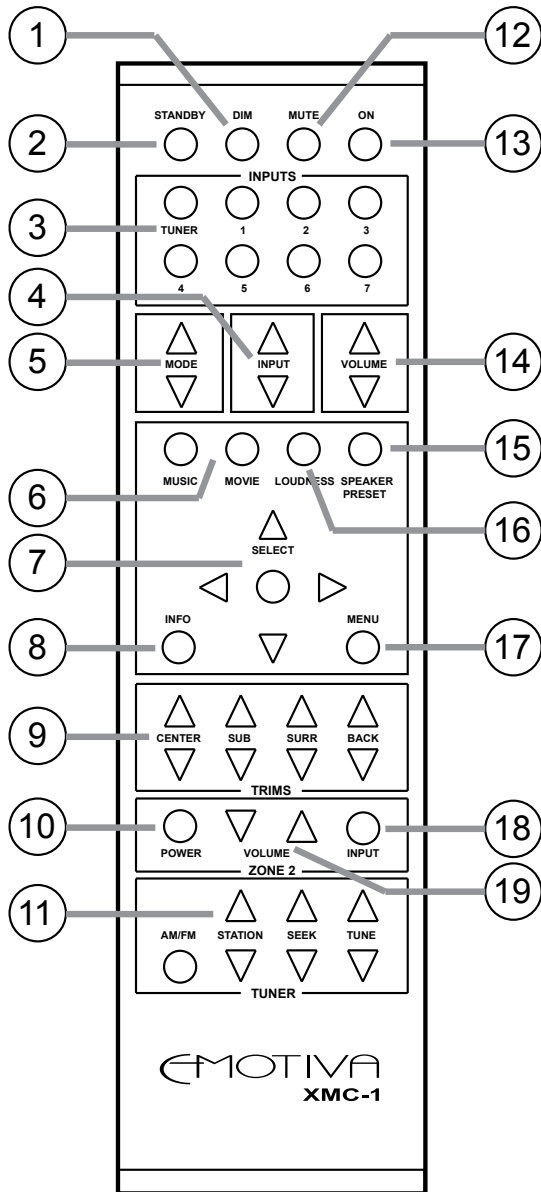

1. Dim Button

Press the Dim button once to display the current Brightness setting; then, press the button repeatedly to adjust the Brightness setting of the XMC-1 front panel display; each subsequent press advances the Brightness one level; if the Brightness is at 100%, the next button press returns it to 0%. (Brightness can be adjusted in six steps: 0%, 20%, 40%, 60%, 80%, 100%).

2. Standby Button

Press the Standby button to switch the XMC-1 from On to Standby mode.

3. Direct Input Selector Buttons

Press one of the Direct Input Selector buttons to switch the XMC-1 directly to a specific input.

Note: Buttons are assigned to specific inputs using the Setup Menu.

4. Input Selector Buttons

Use the Input Selector buttons to cycle through the entire list of available inputs on the XMC-1.

Note: Only Inputs configured as Visible on the Setup Inputs Menu will be shown here.

5. Mode Selector Buttons

Use the Mode Selector buttons to cycle through the available modes for the input you have selected.

Note: The Mode Selector buttons will only allow you to select modes that are valid for the particular input and source content you have selected. When playing DVD and Blu-Ray discs, your player and the disc itself may offer a choice of several audio modes. After you select this output audio format, the XMC-1 will determine which type of audio is being supplied by your source component, and will ONLY allow you to choose audio modes that are compatible with that input signal.

Connecting the XMC-1

6. Music & Movie Mode Buttons

Press the Music or Movie Mode button to select that setting in the decoder. (This will set the Dolby or DTS decoder to use the mode option you select. The audible result will be slightly different depending on what mode you are in.)

7. Menu Navigation Buttons

Use the Select Button (center), and the Up, Down, Left, and Right buttons for navigating the front panel and on-screen menus.

8. Info Button

If the Info screen is already displayed on the XMC-1 front panel display, pressing the Info button will cause the Info screen to display momentarily on the OSD. If the Menu screen is displayed on the XMC-1 front panel, pressing the Info button will cause the Info screen to display momentarily on both the front panel display and the OSD (you will be returned to the Menu screen when the Info screen times out).

9. Trims Adjustments

Use the Trims Adjustment buttons to temporarily adjust the levels on specific sets of speakers.

Note: These Trims are used to make temporary adjustments to speaker levels; for example, to adjust the levels for a particular movie or disc. Since these settings are intended to be temporary, they are NOT retained when you switch Inputs or change Speaker Presets, and they are NOT retained when the XMC-1 is restarted. To make changes to speaker levels which will be retained, use the Levels settings in the Speakers Preset section of the Setup Menu.

10. Zone 2 Power Button

Use the Zone 2 Power button to turn Zone 2 On and Off. Pressing this button once turns Zone 2 On; pressing it again turns Zone 2 Off.

Note: Pressing the Zone 2 Power button will turn Zone 2 On, even if the XMC-1 is in Standby mode, and even if the XMC-1 is configured to use its Lowest Power Standby mode. However, if you turn on Zone 2 while the Main Zone is Off, and while the XMC-1 is in Lowest Power Standby mode, there will be a delay while the XMC-1's operating system is loaded. You can avoid this delay by configuring your XMC-1 to use Video On Standby mode.

11. Tuner Control Buttons

Note: Once you have used the Tuner Direct Input button to select the XMC-1 tuner, the Tuner Control buttons control operation of the tuner.

Press the AM/FM button to toggle between the AM and FM bands. Press the Station Up or Station Down button to move to the previous/next preset station. Press the Seek Up or Seek Down button to instruct the XMC-1 to seek to the previous/next received station. Press or hold the Tune Up or Tune Down button to instruct the XMC-1 to manually seek a station by tuning up or down the frequency band.

Connecting the XMC-1

12. Mute Button

Press the Mute button to mute the audio output on the XMC-1; press it again to unmute the audio.

13. On Button

Press the On button to switch the XMC-1 from Standby mode to On.

14. Volume Up and Volume Down Buttons

Use the Volume Up and Volume Down buttons to raise and lower the audio volume on the XMC-1.

Note: Audio level on the XMC-1 is controlled by an electronic digitally controlled analog ladder network. When you change the Volume using the buttons on the remote control, the Volume knob will not move.

15. Speaker Preset Button

Toggles between the speaker presets: Dirac Live, and the two manual presets, which will show the names you have configured for them.

16. Loudness Button

Press this button to configure the Level Controls on the XMC-1 to act as a true Fletcher-Munson Loudness control; press it again to configure the XMC-1 Level Controls as a standard audio Volume control.

17. Menu Button

Press this button enter the XMC-1 Menu system; press it again to close the Menu and return to normal operation.

18. Zone 2 Input Button

Use the Zone 2 Input button to cycle between the available inputs for Zone 2.

Note: On the XMC-1, the Zone 2 input is selected independently from the main zone. ANY input that is currently selected as the Main Zone Input can also be selected as the Zone 2 Input. If you wish to set the Zone 2 Input to a different source than the main zone, you will be able to select both ANALOG sources and 2 CHANNEL PCM DIGITAL SOURCES. You will NOT be able to select a different digital surround sound or HDMI source for the Zone 2 Input that is different than what is playing in the Main Zone.

19. Zone 2 Volume Button

Use these buttons to raise and lower the volume of the Zone 2 audio outputs.

Connecting the XMC-1

Using The USB Stream Input (the Computer/DAC Input)

The USB Stream Input on the XMC-1 is used to connect the USB digital audio output of a device like a computer or other computer-based USB audio source. Connect your computer to your XMC-1 using a good quality commercial USB cable. Avoid using cables over two meters in length, and avoid unusual “audiophile” cables that may not comply with standard USB data cable specifications.

Note: This input requires a source device that supports USB Audio Class 2 (UAC2). The XMC-1 will appear as an external USB audio device to computers connected to this input. Modern Apple computers support this type of device directly (without any additional drivers); Windows computers will require you to load a driver on the computer (we provide the driver); other operating systems (like Linux) may or may not support this type of connection. You CANNOT connect a USB stick or USB hard drive to this input.

The XMC-1 will appear as a USB audio device (sound card or speaker) to a computer that is connected to this input. Like most audiophile DACs, this input supports two-channel PCM audio at sample rates between 44.1 kHz and 192 kHz at 16 bit or 24 bit depth, and does *NOT* support most multi-channel digital audio formats, including multi-channel PCM audio files or DSD. However, it *DOES* support playback of DTS encoded CDs and audio files (including both two-channel and surround sound types).

Most modern Apple computers have the drivers required to support this type of connection built in. For Windows based computers, you will have to download and install the appropriate drivers. The drivers can be downloaded from the Resources tab on the XMC-1 product page of our website. Instructions for installation can be downloaded from the same location.

Note: The most efficient way to install these drivers is to download and extract the drivers, start the driver Setup procedure, and then connect your XMC-1 to the computer when the driver Setup program prompts you to do so. If you connect your Windows computer to the XMC-1 before installing the drivers, your computer may attempt to automatically download and install drivers from the Internet. If it does so, the automatically downloaded drivers will not work. If this happens, there is no need to remove the incorrect drivers; simply install the correct drivers and your XMC-1 should automatically use them and work as expected.

Care and Maintenance

Periodic Maintenance

Your Emotiva XMC-1 requires no periodic maintenance or calibration.

Cleaning your XMC-1

- If necessary, the XMC-1 should be cleaned gently with a soft rag.
- If something sticky gets on the front panel or case of the XMC-1, it should be cleaned with a mild cleaning solution applied to a soft rag, followed by wiping with a clean rag dampened with plain water and drying with a soft dry rag or cloth.

Note: DO NOT spray water or cleaning solution directly onto the XMC-1 or into the vents.

- If something sticky gets on the remote control, it should be cleaned with a mild cleaning solution applied to a soft rag, followed by wiping with a clean rag dampened with plain water and drying with a soft dry rag or cloth.

Note: DO NOT submerge the remote control in liquid or spray water or cleaning solution directly onto it.

Fuses

The XMC-1 has three fuses that protect it from power surges and other fault conditions.

- A blown fuse does not necessarily indicate a problem; fuses may blow for many reasons, including a power surge in your AC line, or a fault with your XMC-1.
- If a fuse blows, **ALWAYS REPLACE IT WITH ONE OF THE SAME SIZE, RATING, AND TYPE; NEVER USE A FUSE OF HIGHER RATING.**
- If one or more fuses blows repeatedly **CONTACT EMOTIVA TECHNICAL SUPPORT.**

The main AC power fuse for the XMC-1 is located in the IEC power cable receptacle, behind the small plastic panel with the picture of a fuse on it, and is easily accessible without removing the XMC-1's top cover. In addition, there are two power supply fuses located on the power supply board inside the XMC-1.

If you suspect that a fuse is blown, remove the fuse and test it with an ohmmeter or low-current continuity tester. If the fuse measures more than a few ohms of resistance, shows "no continuity", or is obviously cracked or scorched, then it should be replaced.

Note: Always use a modern continuity tester or resistance meter to check fuses. Some older flashlight style continuity testers deliver enough current to blow a low-value fuse, and so should be avoided.

Care and Maintenance

Changing the Main AC Power Fuse

To test or change the main AC power fuse, do the following:

- Unplug the AC power cord from the IEC receptacle on the rear panel of the XMC-1.
- Carefully pry up the small plastic panel with the picture of a fuse on it - located adjacent to the power cable opening. The panel should snap, then slide straight out like a drawer.
- Test the fuse, and replace it if it tests “bad”, or if it is obviously cracked or charred.
- Carefully replace the fuse holder. The little tab on the panel should face towards the power cable cutout. Make sure you have it facing the right way, and that you snap it firmly in place.

Note: The fuse should fit quite loosely in the small plastic clip in the side of the fuse holder. It will engage the electrical fuse contacts tightly when the panel is in its closed position. The fuse holder itself snaps quite firmly into position, and should sit flush when properly inserted.

Changing the Internal Power Supply Fuses

The power supply fuses on the XMC-1 are located on the power supply board, which is located inside the XMC-1, mounted to the bottom of the chassis, towards the front panel, and under the internal protective shielding enclosure. To access the power supply board, you will need to remove both the outside top cover of the XMC-1 and the internal shielding enclosure.

To test or change the power supply fuses, do the following:

- Unplug the AC power cable from the XMC-1.
- Allow the XMC-1 to sit unplugged for ten minutes to ensure that the power supply capacitors are fully discharged.
- You will need access to the top, sides, back, and bottom of the XMC-1, so move it to a location where you have room to work, and be sure to place it on a soft or padded surface to avoid scratching the finish; a clear area on a carpeted floor will work fine.
- Remove and carefully set aside the eight screws securing the top panel to the XMC-1 (three on each side, and two on the rear panel, all near the top edge of the XMC-1).
- Remove and carefully set aside the top cover.
- Remove the four screws securing the shielding enclosure to the front panel of the XMC-1 and carefully set them aside (located just behind the front panel).
- Now, carefully stand the XMC-1 on its side, and remove the two screws on the bottom of the XMC-1 securing the bottom edge of the shielding enclosure to the chassis.
- Place your XMC-1 back in an upright position and remove the shielding enclosure.

Note: You will NOT be required to disconnect any ribbon or other cables to remove the shielding enclosure, however you should be careful to avoid pulling or otherwise damaging or disconnecting any cables while removing the enclosure. You may have to press the corner of the shielding enclosure closest to the Volume knob towards the bottom of the XMC-1, then pull it towards the rear of the XMC-1, to get it to clear the mounting lip on the front panel.

- You should now see the two power supply fuses, located on the top of the power supply board (near the front of the XMC-1; previously under the shielding enclosure).
- Test each fuse, and replace it if it tests “bad”, or if it is obviously cracked or charred.

Care and Maintenance

To close your XMC-1 back up for use after testing or changing the internal fuses, do the following:

- While your XMC-1 is still in an upright position, put the shielding enclosure back in its proper position and replace the four screws securing it to the XMC-1 front panel. Remember that the shielding enclosure mounts *under* the lip on the inside of the front panel, and that the screws go through the front panel lip and thread into the metal of the shielding enclosure.

Note: When you replace the screws, you will not be doing so in the exact reverse of the order in which they were removed. By replacing the four top screws first, you will find it easier to align the two screws on the bottom.

Note: All six screws securing the shielding enclosure are the same size.

Note: Be careful to avoid pulling any cables when positioning the shielding enclosure, or pinching any cables between the enclosure and the chassis when tightening the screws.

- Stand the XMC-1 on its side and replace the two screws securing the shielding enclosure to the chassis of the XMC-1 from the bottom. You may have to push the edge of the shielding enclosure into position and hold it in place while inserting the screws.
- Replace the top panel of the XMC-1, and replace the eight screws securing it.
- Replace the power cable.
- It's a good idea to confirm that your XMC-1 is now working before replacing it in your equipment rack and reconnecting it.

Fuse Values

All fuses are 20mm x 5mm 250 V time delay type: T250

The main AC power fuse is a T250 3.15A (250 V / 3.15 amps)

F1 on the power supply board is a T250 250mA (250 V / 250 mA)

F2 on the power supply board is a T250 4A (250 V / 4 amps)

Care and Maintenance

Changing Remote Control Batteries

Emotiva recommends using high quality Alkaline “N-cell” batteries in the XMC-1 remote control.

Installing the Remote Control Batteries

The back plate of the XMC-1 remote control is attached by magnets. To remove it, simply insert a small screwdriver into the slot on the back plate - toward the bottom - and pry gently.

To install batteries:

- Remove the back plate of the remote control.
- Locate the battery holder.
- Carefully insert the two batteries into the battery holder. The negative end of each battery should face the pressure spring in each section of the battery clip.
- Replace the back plate (the slot should be toward the bottom end of the remote control and the small metal loop next to the slot should be on the inside when the back is in place.)

Your remote control is now ready to use.

Note: Your XMC-1 may arrive with the batteries packaged separately, or the remote control may arrive with batteries already installed, but with a small insulator installed between one battery and the battery contact to prevent the batteries from discharging in shipping. If so, then simply follow the instructions for opening the remote control, and pull out the small insulator strip that is inserted between the end of the battery and the battery contact, before using your remote control.

Replacing the Remote Control Batteries

- Remove the back plate of the remote control.
- Locate the battery holder.
- Note the direction in which the batteries are installed in the holder.
- Remove the depleted batteries and dispose of them in accordance with the manufacturer’s recommendations.
- Insert new batteries, taking care to insert them in the same orientation (facing the same way) as the original batteries.
- Replace the back plate (the slot should be toward the bottom end of the remote control and the small metal loop next to the slot should be on the inside when the back is in place.)

Your remote control is now ready to use.

Care and Maintenance

Updating the XMC-1 Firmware

The firmware update is installed from a standard USB flash drive. The update consists of a single file, which may be downloaded and written to a USB drive, or may be provided on a pre-recorded flash drive.

Note: If you download the firmware update file, it can be written to most standard USB drives. The USB drive you use should be at least 1 GB in size, and should be formatted using a standard FAT32 format; avoid multiple partitions or drives with permanently installed management software, and place the file in the main folder on the drive. Either a USB drive formatted on a Windows computer or a pre-formatted USB drive should work, and the file may be downloaded using either a Windows or Apple computer, but USB drives formatted on Apple computers using the default settings may not work. Instructions for properly formatting a USB drive on an Apple computer will be available for download from the same web page as the firmware update.

Note: ALWAYS erase any previous XMC-1 update files from the USB drive before copying new ones to it - having multiple different firmware update files in the main folder of the same drive may result in unpredictable behavior.

Note: It is perfectly acceptable to use the same USB drive for a firmware update file and a configuration backup.

To update the XMC-1 firmware:

- If necessary, copy the XMC-1 firmware update file onto a standard FAT32 formatted USB flash drive. See the above Notes for details.
- Insert the USB drive into the USB port on the front or back of the XMC-1.
- Press the Menu button.
- Use the Up/Down buttons to select Setup; press the Right button to enter the Setup menu.
- Use the Up/Down buttons to select Advanced; press the Right button to enter the Advanced Setup menu.
- Use the Up/Down buttons to select Firmware Update; press the Right button to enter the confirmation screen.
- Use the Up button to confirm your choice; the confirmation box will change to "X".
- Use the Left button to confirm the update.
- During the update process the screen will display the names of the various firmware modules being updated; for some modules, you will see a progress bar while the update is completed. The entire update process will take approximately three to five minutes.
- When the update process is complete, the XMC-1 will switch into Standby mode.

WARNING! DO NOT REMOVE THE USB STICK OR POWER YOUR XMC-1 OFF BEFORE IT SWITCHES INTO STANDBY AT THE END OF THE UPDATE PROCESS. DOING SO MAY RESULT IN SERIOUS FIRMWARE CORRUPTION WHICH MAY REQUIRE FACTORY SERVICE TO CORRECT.

- Remove the USB drive containing the firmware update.

Note: Unless otherwise instructed, you do NOT have to reset your XMC-1 to factory defaults after updating the firmware. The update process itself will NOT erase your current configuration settings.

Creating a Configuration Backup for the XMC-1

The Backup Settings feature on the XMC-1 allows you to save your entire current configuration onto a USB drive. We STRONGLY suggest that, after configuring your XMC-1 just the way you want it, you save a backup copy of the configuration. You can then use this backup at a later date to restore your XMC-1 to its current configuration. (This is handy if you want to experiment with various options.)

Note: Most standard USB flash drives can be used to create a configuration backup. The USB drive you use should be formatted using a standard FAT32 format; avoid multiple partitions or drives with permanently installed management software. Either a USB drive formatted on a Windows computer or a pre-formatted USB drive should work, but USB drives formatted on Apple computers using the default settings may not work. Instructions for properly formatting a USB drive on an Apple computer will be available on the XMC-1 product page.

Note: The XMC-1 will only store a single configuration file; this file will be stored in the main folder of the drive, under a pre-configured name. When restoring the configuration, the XMC-1 will automatically use this same file. If desired, you can rename the current configuration file to save multiple versions, but you will have to rename it back to the original name and place it in the default location in order for the XMC-1 to recognize it.

Note: It is perfectly acceptable to use the same USB drive for a firmware update file and a configuration backup.

To back up the configuration on your XMC-1:

- Insert the USB drive into the USB port on the front or back of the XMC-1.
- Press the Menu button.
- Use the Up/Down buttons to select Setup; press the Right button to enter the Setup menu.
- Use the Up/Down buttons to select Advanced; press the Right button to enter the Advanced Setup menu.
- Use the Up/Down buttons to select Backup Settings; press the Right button to enter the confirmation screen.
- Use the Up button to confirm your choice; the confirmation box will change to "X".
- Use the Left button to confirm the backup.
- You will see a status message indicating that the backup is in progress, and another message to confirm when it is completed.
- You may remove the USB drive and exit the Setup Menu as soon as the "Done" status message appears.

Note: The XMC-1 has internal storage which can hold one configuration backup. Initiating the Backup Configuration procedure with no USB flash drive inserted will prompt the XMC-1 to save its configuration to internal memory. Initiating a Restore Settings procedure with no USB drive installed will prompt the XMC-1 to restore the internal configuration backup file - if one exists.

Note: The XMC-1 stores a second copy of the configuration file in the same location as the original for safety purposes; this file is a duplicate of the current backup file; it is NOT a backup of the previous configuration.

Restoring a Configuration Backup to the XMC-1

The Restore Settings feature on the XMC-1 allows you restore a previously saved configuration from a USB drive.

Note: RESTORING A SAVED CONFIGURATION WILL REMOVE/DELETE THE CURRENT CONFIGURATION. If you are unsure about whether you wish to do this, you may wish to save the current configuration - on a different USB flash drive - first.

Note: It is perfectly acceptable to use the same USB drive for a firmware update file and a configuration backup.

Note: In order to restore a configuration to the XMC-1, the file containing it must be stored in the default location on the USB drive, and must have the default file name. If you are managing multiple configuration files, be sure to put the one you want in the correct location, and rename it to the default name, before proceeding.

Note: The XMC-1 has internal storage which can hold one configuration backup. Initiating a Restore Settings procedure with no USB drive installed will prompt the XMC-1 to use the internally stored configuration file - if one exists.

To restore a configuration to your XMC-1:

- Insert the USB drive containing your saved configuration file into the USB port on the front or back of the XMC-1.
- Press the Menu button.
- Use the Up/Down buttons to select Setup; press the Right button to enter the Setup menu.
- Use the Up/Down buttons to select Advanced; press the Right button to enter the Advanced Setup menu.
- Use the Up/Down buttons to select Restore Settings; press the Right button to enter the confirmation screen.
- Use the Up button to confirm your choice; the confirmation box will change to "X".
- Use the Left button to confirm the backup.
- You will see a status message indicating that the restore is in progress, and another message to confirm when it is completed.
- You may remove the USB drive and exit the Setup Menu as soon as the "Done" status message appears.

Note: Unless otherwise instructed, you do NOT have to reset your XMC-1 to factory defaults after restoring a stored configuration.

Note: Restoring a saved configuration will restore all SETTINGS; however certain STATUS information will be lost, which may cause it to appear as if settings were lost. For example, if you restore a configuration that designates one or more Inputs as Last Used, then the Inputs themselves will be configured as Last Used, but the XMC-1 won't remember what mode was used last for that Input and signal type; and so it will have to "relearn" your preferences for each Input configured that way.

Note: Dirac Live for Emotiva Correction Filters are NOT part of the XMC-1 stored configuration.

Performing a Factory Reset on the XMC-1

The Factory Reset feature on the XMC-1 allows you restore all settings to their default factory configuration.

Note: Performing a Factory Reset restores all current settings on your XMC-1 to their factory default settings, but does NOT erase the internal configuration backup file stored on the XMC-1 - if one exists.

Note: While the speaker configuration in the Dirac Speaker Preset will be cleared if you perform a Factory Reset on your XMC-1, the actual Dirac Correction Filters currently stored on your XMC-1 will NOT be deleted.

Note: A Factory Reset is used to restore your XMC-1 to its factory default configuration. It is NOT necessary to perform a Factory Reset after performing a Restore Settings. It is NOT necessary to perform a Factory Reset after performing an Update Firmware - unless otherwise noted in the instructions you receive with the update file or from Emotiva Technical Support.

To perform a Factory Reset on your XMC-1:

- Press the Menu button.
- Use the Up/Down buttons to select Setup; press the Right button to enter the Setup menu.
- Use the Up/Down buttons to select Advanced; press the Right button to enter the Advanced Setup menu.
- Use the Up/Down buttons to select Factory Reset; press the Right button to enter the confirmation screen.
- Use the Up button to confirm your choice; the confirmation box will change to "X".
- Use the Left button to confirm the reset.
- You will see a status message indicating that the Factory Reset is in progress, and another message to confirm when it is completed.
- You may exit the Setup Menu as soon as the "Done" status message appears.

Troubleshooting

Problem: My XMC-1 won't respond to the remote control or the front panel controls.

Reason: Your XMC-1 has no power.

- Confirm that the rear panel Power switch is turned On.
- Confirm that the XMC-1 is plugged into an active outlet.
- Check main fuse in the XMC-1.
- Check internal fuses in the XMC-1.

Problem: My XMC-1 won't respond to the remote control (but the front panel controls work fine).

Reason: Your remote control isn't working.

- Confirm that your remote control has good batteries in it.
- If you're using an IR eye or repeater, confirm that it is configured correctly and located in a position where it isn't blocked or being flooded by another IR light source.

Problem: My XMC-1 takes a long time to start up.

Problem: When I turn on the rear panel Power switch, my XMC-1 turns On, goes through a startup routine, then returns to Standby mode; this takes too long.

Reason: You have the Standby mode on your XMC-1 set to Use Least Power so the XMC-1 has to boot up every time you turn it on.

- Set the Standby mode to Video Remains On.

Problem: When I use the Mode Up/Down buttons on the remote control or the front panel, Reference Stereo Mode isn't there.

Reason: Reference Stereo Mode has to be configured in the Setup Menu.

- In the Setup Menu, configure the Input you're using to use Reference Stereo as its default mode. (For each input, you can set separate default modes for 2 channel and surround sound signals; the default setting for both is "Last Used".)

Problem: The Standby button on my XMC-1 blinks whenever I use any remote control near it, even the one for some other piece of equipment; is something wrong?

Reason: Because the XMC-1 can act as a repeater for signals from any remote control, it listens to all IR remote control signals, and the Standby button blinks whenever the XMC-1 is receiving any remote control signal.

- This is normal.

Troubleshooting

Problem: Dirac Live can't see my XMC-1.

Problem: My network remote control can't see my XMC-1.

Reason: Your XMC-1 may not be configured correctly.

- Confirm that your XMC-1, network remote control, and the computer on which you installed Dirac Live, are connected to a live network port attached to your home network.
- Confirm that you have configured your XMC-1 to use DHCP (a standard configuration), or that, if you have selected to configure your XMC-1 manually, it has a valid network address, netmask, and other network settings.
- If you have chosen to manually configure the network settings on your XMC-1, ensure that you have chosen a valid network address and netmask.

Reason: Your home network may not be configured correctly or may not be functioning correctly.

- If you have configured your XMC-1 to use DHCP to obtain its network parameters - which is the default - ensure that your home network DHCP server is functioning properly. (The DHCP server is usually part of your cable modem, router, or firewall.)
- If you have a firewall, ensure that it isn't configured to block the XMC-1 or the computer on which you have installed the Dirac Live software.
- If your home network has multiple routers and switches, connect your Dirac computer and your XMC-1 to ports on the same switch, and ensure that the switch they are connected to has Internet access.
- Confirm that your XMC-1, and the computer on which you installed Dirac Live, have unique network addresses that don't conflict with any other equipment on your home network. (Even if you have configured the XMC-1 to use automatic network configuration, it is still possible for other devices on the network to conflict with either or both of them if your other equipment is configured incorrectly)
- Confirm that your home network is not experiencing a temporary interruption of Internet service. (The Dirac Live software must connect to the servers at Dirac as part of the configuration process; if your Internet connection is down, Dirac Live will not function.)

Note: The XMC-1 must be connected to your home network via a wired Ethernet port. The computer on which you install the Dirac Live software may use a wired or wireless connection. Both must be able to connect to each other, and to the Internet.

Note: If you suspect a network address conflict, and are using automatic DHCP address resolution, try resetting your routers and other network equipment. (Shutting down and unplugging your individual computers, routers, and cable modem, all at the same time, then turning them all back on one at a time, should fully reset the address tables in your equipment. Doing so will often resolve or eliminate many common address conflicts.

Troubleshooting

Problem: It seems like I have to set the Volume on my XMC-1 to a much higher/lower number than I did yesterday to get the same output volume.

Reason: The audio processors in the XMC-1 have a feature called normalization; if you adjust the Tone Trims or Level Trims in such a way that the result is to raise the overall gain, the XMC-1 will use its internal master gain control to ensure that digital audio signals aren't clipped. Because this only happens while you're changing the settings, it doesn't affect the dynamics of the music in any way, but it may alter the Volume setting required to produce a specific output level.

- This is normal.

Note: Normalization is a static setting that affects only the overall gain of the XMC-1 (similar to the Master Gain setting on an equalizer), and is necessary to ensure that excessive boost applied by user configuration settings won't cause the XMC-1 to clip loud passages in the music. Normalization is applied at the time you make each user level or trim setting. It does NOT affect the dynamics or dynamic range of the music.

Problem: My XMC-1 seems to be acting oddly; sometimes the Volume control doesn't work, or the XMC-1 turns itself On or Off when I switch the TV or my Blu-Ray player On.

Reason: CEC is a remote control protocol supported to varying degrees by many TVs and Blu-Ray players. CEC is intended to provide a convenient way for some devices to control others; for example, to allow your Blu-Ray player to tell the XMC-1 to switch On when you insert a disc and press Play. Different vendors may refer to CEC by different names and, unfortunately, implementations vary and not everyone follows the same standard. Your XMC-1 ships with its CEC options disabled by default, but CEC commands exchanged between other devices may still cause problems.

- Disable CEC in your other devices. (Most TVs and many Blu-Ray players have some CEC features). You may have to look online, or consult the manufacturers of your other devices, to determine what they call CEC on their devices. Alternately, you can simply disable any "remote control" features on other equipment that you don't use.
- (We are specifically aware of CEC issues when using the XMC-1 with Oppo model BDP-103 and BDP-105 Blu-Ray players, and we strongly suggest disabling CEC support on them.)

If none of these simple suggestions eliminates your problem, please contact Emotiva Technical Support, at 1-877-366-8324, where a real live person will be happy to get you up and running.

Appendices

XMC-1 Infrared (IR) Remote Control Codes

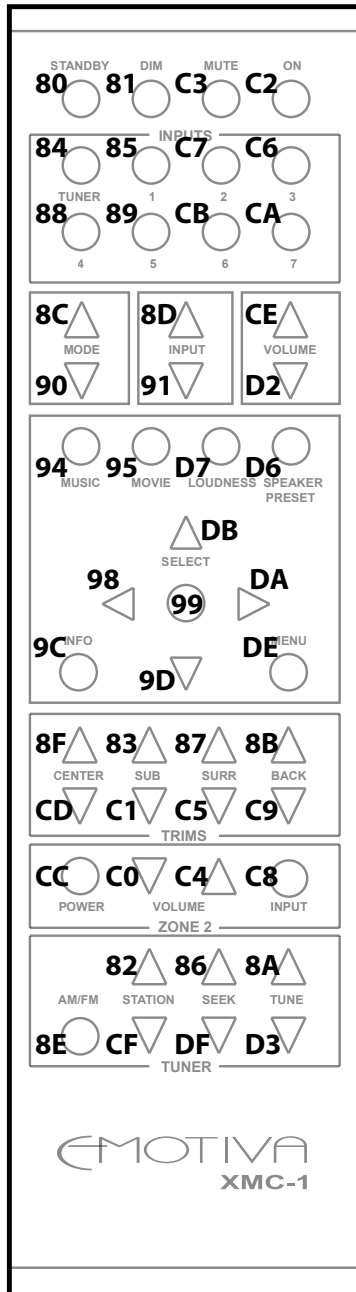

XMC-1

IR Remote Control Codes
Product ID (HEX) 0x79

Importing and Exporting Parametric EQ Filters

The Parametric EQ filter settings for the two manual speaker presets on the XMC-1 can be exported to and imported from a USB stick in the form of a set of XML files. These XML files may be used as a means of archiving your current filter settings, and as a way of exchanging these settings with third party applications that “understand” them (such as Room EQ Wizard). They will also enable the tech-savvy user to manually edit filter settings, and to copy filter settings from one channel or Speaker Preset to another.

Please read and consider the following information carefully before using this feature:

- This feature is only available for the two manual Speaker Presets (not the Dirac Preset).
- To export a set of filters, use the following command:
Setup | Speakers | (Speaker Preset) | Equalization | Export Filters
- To import a set of filters, use the following command:
Setup | Speakers | (Speaker Preset) | Equalization | Import Filters
- Filter settings may only be exported to and imported from a USB thumb drive.
- The files containing the filter settings are standard XML files, which may be read and edited using any standard XML or text editor, but the file locations and names, and the format of the information they contain, must follow the XMC-1’s default format *exactly*. (The easiest way to see this format is to export a set of filters and examine the files the XMC-1 provides.)
- When the XMC-1 is instructed to Export Filters, it always saves a complete set of filters - based on the current speaker configuration for the Speaker Preset you are currently in. The names of the individual files are based on the channel they represent (the files have a .EMO file extension), the name of the overall folder is based on the name of the current Speaker Preset, **AND THIS INFORMATION IS ALSO CONTAINED INSIDE EACH FILE IN THE FORM OF XML INFORMATION.**
- When the XMC-1 is instructed to Import Filters, it will read all filter files present in the appropriate folder, and replace the settings in the XMC-1 with those contained in the files. Files that are missing will be ignored. (So, if you only have files for your Front Left and Front Right channels in the folder, either because you deleted the others, or because you only instructed REW to save files for those channels, settings for those two channels will be read into the XMC-1, and settings for the other channels will remain unchanged.)
- If you manually enter parameter values into the files, or values are entered by a third-party program, and those values aren’t a precise match for what the XMC-1 expects (perhaps the XMC-1 stores band gain in 0.5 dB steps and you enter a value of +3.279 instead of +3.5), the XMC-1 will do its best to use the nearest value it supports. However, entering values that are out of bounds or “between steps” may produce unexpected results.

Appendices

Here's a simple example that illustrates how this feature works:

We'll use this feature to copy the PEQ settings for the Front Left speaker in Speaker Preset 2 into the Front Right speaker channel in the same Speaker Preset.

- First we'll go into the Setup Menu (on the XMC-1) and we'll Export Filters from Speaker Preset 2.
- This will give us a set of files, one for each speaker channel, in a folder on our USB stick named "filtersPreset2".
- For our example, we will delete all of these files except the one named "leftFront.EMO", which is the file that contains the current settings for our Left Front speaker in this preset.
- We will now rename this file to "rightFront.EMO".
- We will also use our favorite text or XML editor to change the information inside the file to match the new name. (We'll change the XML information near the top of the file from speaker location="leftFront" to speaker location="rightFront").
- Now we'll go into the Setup Menu (on the XMC-1) and we'll Import Filters to Speaker Preset 2.
- When we do this, our new (modified) file containing settings for the Front Right speaker in Preset 2 will be imported, and the settings in the file will replace the current settings on the XMC-1 for that channel in that preset.

Note: Each XML file internally contains information that identifies which channel it goes with, but does NOT contain the name of the associated Speaker Preset internally. This means that you CAN, for example, copy ALL your settings from Preset 1 to Preset 2 by Exporting Filters for Preset 1 and then simply renaming the FOLDER containing the files from filtersPreset1 to filtersPreset2.

Exporting EQ Settings from Room EQ Wizard (to the XMC-1)

The latest version of Room EQ Wizard now includes the ability to export correction filters in a format which can then be imported directly into the XMC-1. REW handles each channel individually, so you must save the information for each channel separately and then combine the files into an appropriately named folder on a USB stick. You will then use the Import Filters command on your XMC-1 to import your saved filter files into the XMC-1.

- In REW, in the EQ panel (or in Preferences), set your Equaliser to "XMC-1".

For each correction filter you wish to save, do the following:

- In REW, in the EQ panel, under Filter Tasks, click Send Filter Settings to Equaliser.
- In the pull-down box, select the speaker channel on the XMC-1 with which to associate the exported settings for the current filter.
- The current settings will then be saved in the folder you select, in the correct format, and with the correct file name, ready for import into the XMC-1.

Appendices

Note on FILE FORMATS AND NAMES: All of the individual XML files containing the settings for each channel **MUST** be placed into a single folder on your USB stick; and the folder must have the appropriate name for the Speaker Preset into which you plan to import it.

Files for import into Speaker Preset 1 must be placed in a folder named "filtersPreset1".

Files for import into Speaker Preset 2 must be placed in a folder named "filtersPreset2".

Note: if you find the file naming and folder conventions confusing, it may be easier to Export Filters from the XMC-1 first, which will create the appropriate folders and files on your USB stick, then simply replace the files you wish to update.

Note: The XMC-1 can only Import Filters and Export Filters using a USB thumb drive. You **CANNOT** use the internal storage on the XMC-1 for this purpose.

Note: Each XML file internally contains information that identifies which channel it goes with, but **NOT** the name of the associated Speaker Preset. So, for example, the export file named "rightFront.EMO" is internally identified as being for a Right Front Speaker, but it can be used with either Speaker Preset 1 or Speaker Preset 2, depending on the name of the folder in which you place it on the USB stick.

You **CAN** alter the file to be applied to a different speaker, but to do so you will have to both rename the file **AND** alter the XML item text inside the file which identifies the speaker it was created for.

Note: When the XMC-1 is instructed to Import Filters, it will read all filter files present in the appropriate folder, and replace the settings in the XMC-1 with those contained in the files. Files that are missing will be ignored, and the settings for the channels associated with the missing files will remain unchanged. If you wish to import REW settings for only certain speakers, simply create filter setting files for only those channels; the settings in the files present will be imported and will replace the current settings in the XMC-1 Speaker Preset for those channels, while all other speaker settings in that Speaker Preset will remain unchanged.

Note: If you wish to individually import REW correction settings for specific channels, and clear all other channels, simply do a Reset Filters to clear all settings for that Speaker Preset, then individually update the settings for any individual channels. You can use this method to update channels one at a time.

Warranty

Emotiva Audio Corporation Limited Warranty

What does this warranty cover?

Emotiva Audio Corporation (“Warrantor”) warrants its products against defects in materials and workmanship.

How long does this coverage last?

This warranty commences on the date of retail purchase by the original retail purchaser and runs for a period of five years thereafter, with the exception of products in the Fusion Series, which are warranted for a period of three years from the date of retail purchase by the original retail purchaser. This warranty is transferable to any person that owns the warranted product during the Term. Warrantor warrants any replacement product or part furnished hereunder against defects in materials and workmanship for the longer of the following: (i) the amount of time remaining under the original warranty, or (ii) 120 days from your receipt of the repaired or replaced product. The duration described in this paragraph is hereinafter referred to as the “Term”.

TO THE FULLEST EXTENT PERMITTED BY LAW, ALL IMPLIED WARRANTIES RELATED TO THE ORIGINAL PRODUCT AND ANY REPLACEMENT PRODUCT OR PARTS (INCLUDING IMPLIED WARRANTIES OF MERCHANTABILITY AND FITNESS FOR A PARTICULAR PURPOSE) ARE EXPRESSLY LIMITED TO THE TERM OF THIS LIMITED WARRANTY. SOME STATES DO NOT ALLOW LIMITATIONS ON HOW LONG AN IMPLIED WARRANTY LASTS, SO THE ABOVE LIMITATION MAY NOT APPLY TO YOU.

A claim under this warranty must be made by you within the Term. A claim shall not be valid (and Warrantor has no obligation related to the claim) if it is not made within the Term and if it is not made in strict compliance with the requirements of the “How do you get service?” section.

What will Warrantor do?

Warrantor will, at its option, either: (i) repair the product, or (ii) replace the product with a new consumer product which is identical or reasonably equivalent (in Warrantor’s sole discretion) to the product. In the event Warrantor is unable to provide replacement and repair is (in Warrantor’s sole discretion) not commercially practicable or cannot (in Warrantor’s sole discretion) be timely made, then: (i) if the claim was submitted during the first 365 days of the Term, Warrantor shall refund to you the purchase price that you paid for the product; and (ii) if the claim was submitted after the first 365 days of the Term, Warrantor shall issue you a credit equal to the purchase price that you paid for the product. The credit can only be used for the purchase of merchandise and cannot be used for freight / shipping.

When a product or part is repaired or replaced, any replacement item becomes your property and the replaced item becomes Warrantor’s property. When a refund or credit is given, the product for which the refund or credit is provided must be returned to Warrantor and becomes Warrantor’s property.

Warranty

What is not covered by this warranty?

This warranty does not apply: (i) to damage caused by use with products not manufactured by Warrantor, where the non-Warrantor product is the cause of the damage; (ii) to damage caused by service or maintenance performed by anyone who is not a representative of Warrantor; (iii) to damage caused by accident, abuse, misuse, flood, fire, earthquake or other external causes; (iv) to a product or part that has been modified after its retail purchase, where the modification caused or contributed to the damage; (v) to consumable parts, such as batteries; or (vi) if any Warrantor serial number has been removed or defaced on the product. WARRANTOR SHALL NOT BE LIABLE FOR ANY INCIDENTAL OR CONSEQUENTIAL DAMAGES ARISING FROM OR RELATED TO ANY DEFECTS IN OR DAMAGES TO ITS PRODUCTS. SOME STATES DO NOT ALLOW THE EXCLUSION OR LIMITATION OF INCIDENTAL OR CONSEQUENTIAL DAMAGES, SO THE ABOVE LIMITATION OR EXCLUSION MAY NOT APPLY TO YOU.

How do you get service?

In order to make a claim under the warranty, you must:

1. Call or email a customer service representative at 1-877-EMO-TECH (1-877-366-8324) or support@emotiva.com. Provide a description of your problem and the serial number of the product for which the warranty claim is being made.
2. You will be provided with a returned material authorization number ("RMA").
3. Ship the product to the following address, with the RMA written in large, bold numbers on the outside of the box, and with the letters "RMA" written before the number. Parcels arriving without a RMA number on the outside of the box will be refused. The customer pays for the shipping to Warrantor and Warrantor pays for the shipping back to the customer, as applicable.

Emotiva Audio Corporation
Attn: Repair Department
139 Southeast Parkway Court
Franklin, TN 37064

How does state law apply?

This warranty gives you specific legal rights, and you may also have other rights, which vary from state to state.

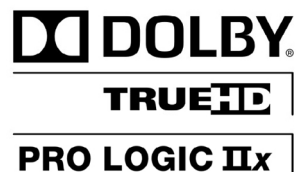

Manufactured under license under U.S. Patent Nos: 5,956,674; 5,974,380; 6,226,616; 6,487,535; 7,212,872; 7,333,929; 7,392,195; 7,272,567 & other U.S. and worldwide patents issued & pending. DTS-HD, the Symbol, & DTS-HD and the Symbol together are registered trademarks & DTS-HD Master Audio is a trademark of DTS, Inc. Product includes software. © DTS, Inc. All Rights Reserved.

This product is manufactured under license from Dolby Laboratories. "Dolby", "Pro Logic" and the double-D symbol are trademarks of Dolby Laboratories.

All other trademarks are the property of their respective owners.



Emotiva Audio Corporation
135 Southeast Parkway Court
Franklin, TN 37064
www.emotiva.com