



# FANTOM

## Reference Manual

# Contents

## 01: Overview 7

### Panel Descriptions 8

- ◇ Top Panel 8
- ◇ Rear Panel (Connecting Your Equipment) 10

### Basic Operation 11

- ◇ Editing a Value 11
  - [INC] [DEC] Buttons 11
  - [VALUE] Dial 11
  - Display (Touch Panel) 11
  - NUMERIC Window 11
  - List Window 11
- ◇ Moving the Cursor 12
  - Cursor [▲] [▼] [◀] [▶] Buttons 12
  - Display (Touch Panel) 12
- ◇ Confirming or Canceling the Value 12
  - [ENTER] Button 12
  - [EXIT] Button 12
  - Display (Touch Panel) 12
- ◇ [SHIFT] Button 12
- ◇ FUNCTION Knobs [E1]–[E6] 12
- ◇ Knob and Slider Operations 12
- ◇ [MENU] Button 12
- ◇ Operations in the Display 13
  - SCENE SELECT Screen 13
  - TONE EDIT Screen 13
  - ZONE VIEW Screen 13
  - MENU Screen 13
  - RENAME Screen 13
  - REC STANDBY Screen 13

### An Overview of FANTOM 14

- ◇ Basic Structure 14
  - Synthesizer 14
  - Sequencer 14
  - Sampler 14
  - Controller 14
- ◇ Units of Sound 15
  - TONE 15
  - ZONE 15
  - SCENE 15
- ◇ About the Effects 16
- ◇ About Memory 17

## Getting Ready 18

- ◇ Placing This Unit on a Stand 18
  - If You're Using the FANTOM-6/FANTOM-7 18
  - If You're Using the FANTOM-8 19
- ◇ Turning the Power On 20
- ◇ Turning the Power Off 20
- ◇ Making the Power Automatically Turn off After a Time (Auto Off) 20
  - Changing the Auto Off Setting 20

## 02: Performing 21

### Selecting a Sound (SCENE/TONE) 22

- ◇ Selecting a Scene 22
  - Selecting a Bank 22
  - Quick Edit 22
- ◇ Selecting a Tone 23
  - Selecting Tones in a Category (Category Lock) 23
  - Selecting Tones from a List 23

### Performing 24

- ◇ Playing One Tone in One Zone (Single) 24
- ◇ Layering Zones (Layer) 24
  - Selecting a Tone (Layer) 25
- ◇ Dividing the Keyboard into Two Regions (Split) 25
  - Changing the Keyboard's Split Point 25
  - Selecting a Tone (Split) 25
- ◇ Playing Multiple Zones 26
  - Specifying the Range of Each Zone (KEY RANGE) 26

### Changing the Keyboard Settings 27

- ◇ Raising/Lowering the Key Range in Semitone Steps (Transpose) 27
- ◇ Raising/Lowering the Key Range in Octaves (Octave) 27

<b>03: Performance Functions</b>	<b>29</b>
<b>Playing Arpeggios</b>	<b>30</b>
◇ Using the Arpeggiator	30
◇ Setting the Arpeggiator Tempo	30
◇ Holding the Arpeggio (Hold)	31
Using a Pedal Switch	31
◇ Arpeggiator Settings	31
<hr/>	
<b>Playing Chords (Chord Memory)</b>	<b>32</b>
◇ Performing with the Chord Memory Function	32
◇ Chord Memory Settings	32
<hr/>	
<b>Performing with Rhythm Patterns</b>	<b>33</b>
◇ Selecting/Playing Rhythm Patterns	33
◇ Editing a Rhythm Pattern Group	34
Saving a Rhythm Pattern Group	34
◇ Changing the Tempo of the Rhythm Pattern	35
◇ Saving the Rhythm Pattern Settings	35
<hr/>	
<b>Playing the General-Purpose Controllers</b>	<b>36</b>
◇ Using the Sliders and Control Knobs	36
◇ Using Other General-Purpose Controllers	37
<hr/>	
<b>Playing the Edit Knobs</b>	<b>38</b>
◇ Using the Edit Knobs	38
<hr/>	
<b>Simultaneously Modifying the Volume of Multiple Zones (Motional Pad)</b>	<b>39</b>
◇ Using the Motional Pad	39
◇ Editing the Motional Pad Settings	39
Changing the Assigned Zones	39
Switching the Tone Assigned to a Zone	39
Other Settings for Motional Pad	40

<b>04: Editing</b>	<b>41</b>
<b>Editing a Scene (Zone)</b>	<b>42</b>
◇ Editing the Overall Scene	42
Initializing a Scene (UTILITY)	42
◇ Editing a Zone	43
Initializing a Zone (UTILITY)	43
◇ Editing a Scene's Appearance	44
◇ Saving a Scene	44
<hr/>	
<b>Editing a Tone</b>	<b>45</b>
◇ Basic Tone Editing	45
◇ ZEN-Core Tone (TONE TYPE: Z-Core)	45
Editing in the TONE EDIT PRO Screen	46
◇ Drum Kit Tone (TONE TYPE: Drum)	46
◇ V-Piano Tone (TONE TYPE: VPno)	47
◇ Saving a Tone	48
◇ Initializing a Tone (Tone Initialize)	48
◇ Initializing a Partial (Partial Initialize)	48
◇ Copying a Partial (Partial Copy)	49
◇ Using the Edit Knobs	49
<hr/>	
<b>Editing the Effects</b>	<b>50</b>
◇ Basic Operation for Effect Editing	50
◇ Editing the Effects of Each Zone	50
◇ Editing Effects Shared by All Zones	51
◇ Editing the Analog Filter	53
Editing the Analog Filter Settings	53
Using the Analog Filter	54
◇ Editing the System-Wide Effects	55
◇ Editing the Sampling Input Effects	56
◇ Applying Effects to the Sampler	56
Specifying the Sampler Output Destination	56
◇ Specifying the Output Destination for USB Input	57
◇ Specifying the Click Tone Output Destination	57
<hr/>	
<b>Using the Mixer Screen</b>	<b>58</b>
◇ Adjusting the Pan and Volume in the MIXER Screen	58
Making ZONE EQ Settings in the MIXER Screen	59
<hr/>	
<b>Recalling Scenes in the Order of Songs (Scene Chain)</b>	<b>60</b>
◇ Using Scene Chain	60
◇ Creating a Chain Set	61
◇ Editing a Chain Set	62

**05: Sampler 63**

**Playing Samples** ..... 64

- ◇ Pressing Pads to Play Samples ..... 64
- ◇ Sustaining the Sample Playback (Hold) ..... 64
- ◇ Switching Banks ..... 64
- ◇ Moving/Copying a Sample ..... 65
  - Moving a Sample ..... 65
  - Copying a Sample ..... 65
- ◇ About the SAMPLE PAD Screen ..... 65

---

**Sampling** ..... 66

- ◇ Preparing for Sampling ..... 66
  - Specifying the Input Volume (Input Setting) ..... 66
- ◇ Sampling ..... 67
- ◇ Importing an Audio File ..... 68

---

**Editing a Sample** ..... 70

- ◇ Using Quick Edit ..... 70
- ◇ Using Wave Edit ..... 70
- ◇ Using the Sample Utility Functions ..... 71
  - Renaming the Sample (RENAME) ..... 71
  - Cutting Unwanted Regions from the Sample (TRUNCATE) ..... 71
  - Deleting a Sample (DELETE) ..... 72
  - Deleting All Samples (DELETE ALL) ..... 72
  - Exporting the Sample in WAV Format (EXPORT WAV) .. 72
  - Exporting All Samples in WAV Format (EXPORT ALL WAV) ..... 72

**06: Pads 73**

**Assigning Convenient Functions to the Pads (PAD MODE)** ..... 74

- ◇ Basic Pad Mode Operation ..... 74
- ◇ Playing Samples (Sample Pad) ..... 74
- ◇ Playing Tones (Note Pad) ..... 74
- ◇ Selecting Partial and Turning Them On/Off (Partial Sw/Sel) ..... 75
- ◇ Controlling a DAW (DAW Control) ..... 75
- ◇ Switching Zone Mute (Zone Mute) ..... 76
- ◇ Switching Zone Solo (Zone Solo) ..... 76
- ◇ Turning the Keyboard Switch Group On/Off (Kbd Sw Group) ..... 76
- ◇ Playing Rhythm Patterns (Rhythm Pattern) ..... 77
- ◇ Using the System Settings (System) ..... 77

**07: Sequencer 79**

**How the Sequencer Is Structured** ..... 80

- ◇ Pattern ..... 80
- ◇ Group ..... 80
- ◇ Song ..... 80

---

**Playing the Sequencer** ..... 81

- ◇ Playing Pattern ..... 81
  - Making Loop Settings (LOOP) ..... 82
  - Setting the Tempo ..... 82
  - Muting a Track (MUTE) ..... 83
  - Soloing a Track (SOLO) ..... 83
- ◇ Playing Group ..... 84
- ◇ Playing Song ..... 84
  - Showing the Timeline as Measures ..... 84

**Song Production Workflow** ..... 85

**Recording a Pattern** ..... 86

- ◇ Ways to Record a Pattern ..... 86
- ◇ Preparing for Recording ..... 86
- ◇ Realtime Recording (Real Time REC) ..... 86
  - Removing Unwanted Data During Recording (Realtime Erase) ..... 87
- ◇ Step Recording (Step REC) ..... 88
- ◇ TR-REC ..... 89
- ◇ Editing a Pattern ..... 91
  - Convenient Functions (Pattern Utility) ..... 91
  - Applying Various Edits (MODIFY) ..... 92
- ◇ Importing SMF as a Pattern (IMPORT) ..... 94
- ◇ Exporting a Pattern as SMF (EXPORT) ..... 95
- ◇ Saving a Pattern ..... 95

<b>How to Create a Group</b> .....	<b>96</b>
◇ <b>Creating a Group</b> .....	<b>96</b>
Naming a Group (RENAME) .....	<b>96</b>
◇ <b>Editing a Group</b> .....	<b>97</b>
Basic Operation in the GROUP Screen.....	<b>97</b>
Specifying the Loop Settings (Length).....	<b>97</b>
Naming a Group (RENAME) .....	<b>97</b>
Initializing a Group (INITIALIZE) .....	<b>97</b>
◇ <b>Exporting a Group as SMF</b> (EXPORT) .....	<b>97</b>
◇ <b>Saving a Group</b> .....	<b>97</b>

<b>How to Create a Song</b> .....	<b>98</b>
◇ <b>Creating a Song</b> .....	<b>98</b>
◇ <b>Editing a Song</b> .....	<b>98</b>
Basic Operation in the SONG Screen .....	<b>98</b>
Skipping a Specific Group (SKIP) .....	<b>98</b>
Editing the Song's Structure (SONG EDIT).....	<b>99</b>
◇ <b>Adjusting the Pan and Volume Balance</b> .....	<b>100</b>
◇ <b>Exporting a Song as SMF</b> (EXPORT) .....	<b>100</b>
◇ <b>Saving a Song</b> .....	<b>100</b>

**08: Control 101**

<b>Connecting a Computer via USB</b> .....	<b>102</b>
◇ <b>Connecting to Your Computer</b> .....	<b>102</b>
◇ <b>USB Driver Settings</b> .....	<b>102</b>
◇ <b>Performing Live with a Plug-In Synthesizer</b> ....	<b>102</b>
◇ <b>Using USB Audio</b> .....	<b>102</b>
Adjusting the USB Audio Input .....	<b>102</b>
Adjusting the USB Audio Output .....	<b>102</b>
Using the Buttons and Sliders to Make Adjustments .....	<b>103</b>

<b>Controlling an External MIDI Device</b> (EXT MIDI OUT) .....	<b>104</b>
◇ <b>Controlling an External MIDI Device</b> .....	<b>104</b>

<b>Controlling an Analog Synthesizer</b> (CV/GATE OUT).....	<b>105</b>
◇ <b>About the FANTOM's CV/GATE</b> .....	<b>105</b>
◇ <b>Using CV/GATE</b> .....	<b>105</b>

**09: Settings 107**

<b>Convenient Functions (Utility)</b> .....	<b>108</b>
◇ <b>Basic Utility Operations</b> .....	<b>108</b>
◇ <b>Backing Up User Data to a USB Flash Drive</b> (BACKUP) .....	<b>108</b>
◇ <b>Restoring Backup Data into the FANTOM</b> (RESTORE) .....	<b>108</b>
◇ <b>Formatting a USB Flash Drive</b> (USB MEMORY FORMAT) .....	<b>109</b>
◇ <b>Returning to the Factory Settings</b> (Factory Reset) .	<b>109</b>
◇ <b>Returning the Contents of Internal Storage to the Factory Settings</b> (Internal Storage Initialize).....	<b>109</b>

<b>Convenient Functions (File Utility)</b> .....	<b>110</b>
◇ <b>Regarding Folder Structure</b> .....	<b>110</b>
◇ <b>Basic Procedure for File Utilities</b> .....	<b>110</b>
◇ <b>Renaming a File or Folder</b> (RENAME) .....	<b>110</b>
◇ <b>Deleting a File or Folder</b> (DELETE) .....	<b>110</b>
◇ <b>Copying a File or Folder</b> (COPY) .....	<b>110</b>
◇ <b>Moving a File or Folder</b> (MOVE) .....	<b>111</b>
◇ <b>Creating a New Folder</b> (CREATE FOLDER) .....	<b>111</b>

<b>Settings for the Entire FANTOM</b> .....	<b>112</b>
◇ <b>Basic Procedure for System Settings</b> .....	<b>112</b>
◇ <b>Saving the System Settings</b> .....	<b>112</b>
◇ <b>System Parameter</b> .....	<b>112</b>
Overall Settings (GENERAL) .....	<b>112</b>
Keyboard Settings (KEYBOARD) .....	<b>113</b>
Pedal Settings (PEDAL) .....	<b>113</b>
Wheel Settings (WHEEL 1/2) .....	<b>114</b>
S1/S2/S3 Settings (S1/S2/S3).....	<b>114</b>
Slider Settings (SLIDER) .....	<b>114</b>
Knob Settings (KNOB) .....	<b>114</b>
USB Audio Settings (USB AUDIO).....	<b>115</b>
MIDI Settings (MIDI) .....	<b>115</b>
CV/GATE Settings (CV/GATE) .....	<b>116</b>
Sound Settings (SOUND) .....	<b>116</b>
Synchronization Settings (SYNC/TEMPO) .....	<b>117</b>
Click Settings (CLICK) .....	<b>117</b>
Note Pad Settings (NOTE PAD) .....	<b>117</b>
Control Function Settings (CONTROL) .....	<b>117</b>
Information About the FANTOM Itself (INFO) .....	<b>117</b>

<b>10: Appendix</b>	<b>119</b>
<b>Chord Memory List</b> .....	<b>120</b>
<b>Block Diagram</b> .....	<b>122</b>
<b>Error Message List</b> .....	<b>123</b>
<b>Troubleshooting</b> .....	<b>124</b>
<b>MIDI Implementation Chart</b> .....	<b>128</b>
<b>Main Specifications</b> .....	<b>130</b>

# 01: Overview

## Contents

<b>Panel Descriptions</b> .....	<b>8</b>	<b>An Overview of FANTOM</b> .....	<b>14</b>
◇ <b>Top Panel</b> .....	<b>8</b>	◇ <b>Basic Structure</b> .....	<b>14</b>
◇ <b>Rear Panel</b> (Connecting Your Equipment) .....	<b>10</b>	Synthesizer .....	<b>14</b>
<hr/>		Sequencer .....	<b>14</b>
<b>Basic Operation</b> .....	<b>11</b>	Sampler .....	<b>14</b>
◇ <b>Editing a Value</b> .....	<b>11</b>	Controller .....	<b>14</b>
[INC] [DEC] Buttons .....	<b>11</b>	◇ <b>Units of Sound</b> .....	<b>15</b>
[VALUE] Dial .....	<b>11</b>	TONE .....	<b>15</b>
Display (Touch Panel) .....	<b>11</b>	ZONE .....	<b>15</b>
NUMERIC Window .....	<b>11</b>	SCENE .....	<b>15</b>
List Window .....	<b>11</b>	◇ <b>About the Effects</b> .....	<b>16</b>
◇ <b>Moving the Cursor</b> .....	<b>12</b>	◇ <b>About Memory</b> .....	<b>17</b>
Cursor [▲] [▼] [◀] [▶] Buttons .....	<b>12</b>	<hr/>	
Display (Touch Panel) .....	<b>12</b>	<b>Getting Ready</b> .....	<b>18</b>
◇ <b>Confirming or Canceling the Value</b> .....	<b>12</b>	◇ <b>Placing This Unit on a Stand</b> .....	<b>18</b>
[ENTER] Button .....	<b>12</b>	If You're Using the FANTOM-6/FANTOM-7 .....	<b>18</b>
[EXIT] Button .....	<b>12</b>	If You're Using the FANTOM-8 .....	<b>19</b>
Display (Touch Panel) .....	<b>12</b>	◇ <b>Turning the Power On</b> .....	<b>20</b>
◇ <b>[SHIFT] Button</b> .....	<b>12</b>	◇ <b>Turning the Power Off</b> .....	<b>20</b>
◇ <b>FUNCTION Knobs [E1]–[E6]</b> .....	<b>12</b>	◇ <b>Making the Power Automatically Turn off</b> <b>After a Time (Auto Off)</b> .....	<b>20</b>
◇ <b>Knob and Slider Operations</b> .....	<b>12</b>	Changing the Auto Off Setting .....	<b>20</b>
◇ <b>[MENU] Button</b> .....	<b>12</b>		
◇ <b>Operations in the Display</b> .....	<b>13</b>		
SCENE SELECT Screen .....	<b>13</b>		
TONE EDIT Screen .....	<b>13</b>		
ZONE VIEW Screen .....	<b>13</b>		
MENU Screen .....	<b>13</b>		
RENAME Screen .....	<b>13</b>		
REC STANDBY Screen .....	<b>13</b>		

# Panel Descriptions

## Top Panel

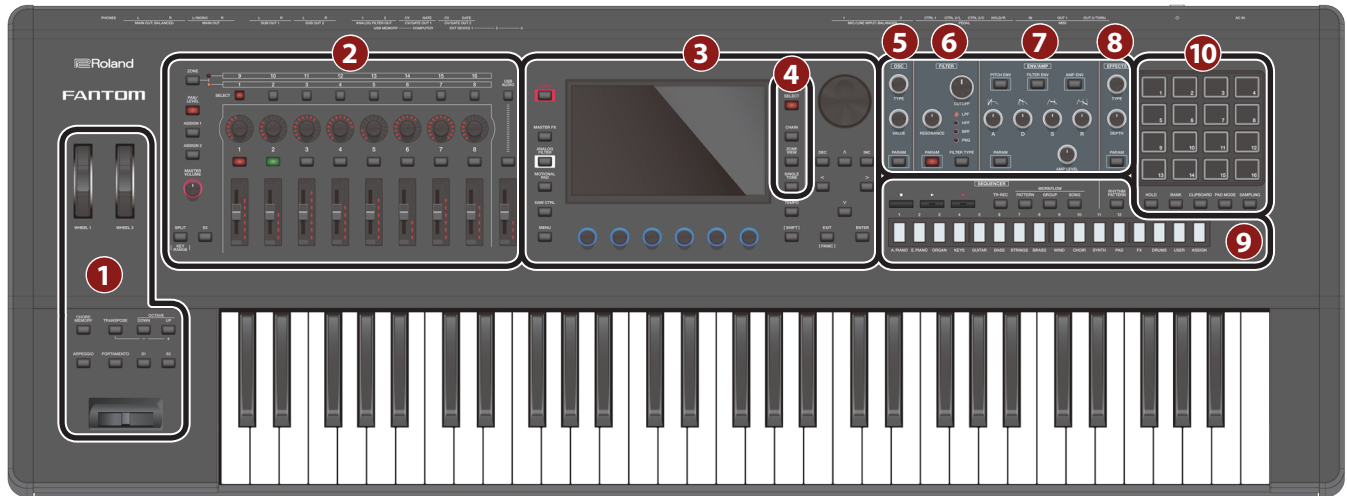

### 1 Controller section

Controller	Explanation
WHEEL 1 WHEEL 2	You can assign various parameters or functions to these wheels. To use the assigned function, move a wheel while you perform. If you operate the controller while holding down the [SHIFT] button, the setting screen appears.
[CHORD MEMORY] button	Turns the chord memory function on/off.
[TRANPOSE] button	Hold down this button and use the OCTAVE [DOWN] [UP] buttons to raise or lower the pitch range in semitone steps.
OCTAVE [DOWN] [UP] buttons	Raise or lower the pitch range in steps of an octave.
[ARPEGGIO] button	Turns the arpeggiator on/off.
[PORTAMENTO] button	Turns the portamento on/off.
[S1] [S2] buttons	Various parameters or functions can be assigned to these buttons. Hold down the [SHIFT] button and press one of these buttons to access a screen that lets you assign a function.
Pitch bend/Modulation lever	Varies the pitch or applies vibrato.

### 2 Zone section

Controller	Explanation
[ZONE 1-8/9-16] button	Switches the zones that you're operating.
[PAN/LEVEL] button	If you press the button to make it light, control knobs [1]–[8] adjust the pan of each zone, and sliders [1]–[8] adjust the volume of each zone.
[ASSIGN1] button [ASSIGN2] button	Assign other functions to sliders [1]–[8] and control knobs [1]–[8]. ASSIGN1 assigns parameters that you set for a scene, and ASSIGN2 assigns parameters that you edit in system settings. Hold down the [SHIFT] button and press one of these buttons to access a screen that lets you assign a function.
[MASTER VOLUME] knob	Adjusts the volume that is output from the MAIN OUT jacks and the PHONES jack.
[SPLIT/KEY RANGE] button	Turns the split function on/off. If you hold down the [SHIFT] button and press this button, the key range setting screen appears.
[S3] button	Various parameters or functions can be assigned to these buttons. Hold down the [SHIFT] button and press one of these buttons to access a screen that lets you assign a function.
ZONE SELECT button [1]–[8]	Select the zone that you want to control (the current zone). The selected zone becomes the current zone.

Controller	Explanation
Control knobs [1]–[8]	Various parameters or functions can be assigned to these knobs. The parameters that can be controlled depend on the function select buttons located at the left.
ZONE INT/EXT buttons [1]–[8]	Specify whether the applicable zone does sound or does not sound when you play the keyboard. In conjunction with the current zone, this determines how the internal sound engine (external sound module) produces sound.

Button status	When the applicable zone is the current zone	When the applicable zone is not the current zone
Unlit (COMMON)	The internal sound engine and the external sound module both produce sound when you play the keyboard.	Neither the internal sound engine nor the external sound module produce sound when you play the keyboard. You can use the internal sequencer or MIDI data from an external device to play the internal sound engine.
Lit red (INT)	The internal sound engine produces sound when you play the keyboard.	Only if the ZONE INT/EXT button of another current zone is on (lit red or green), the internal sound engine produces sound when you play the keyboard.
Lit green (EXT)	The external sound module produces sound when you play the keyboard.	Only if the ZONE INT/EXT button of another current zone is on (lit red or green), the external sound module produces sound when you play the keyboard.
Lit orange (MUTE)	The sound engine is muted. The internal sound engine does not produce sound. If the immediately previous state was lit green, the external sound module produces sound.	

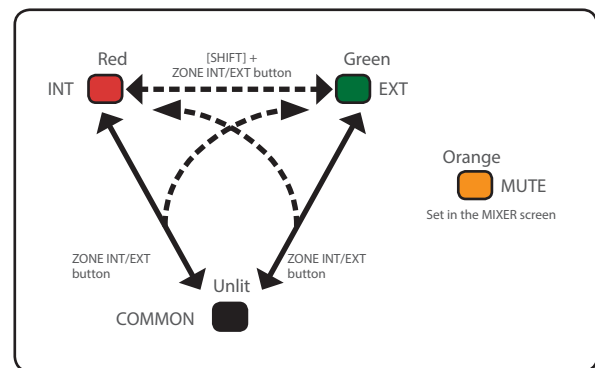

Sliders [1]–[8]	Various parameters or functions can be assigned to these sliders. The parameters that can be controlled depend on the function select buttons located at the left.
[USB AUDIO SELECT] button	The USB AUDIO setting screen appears.
[USB AUDIO IN/OUT] button	Switches the function of the USB AUDIO slider between input and output, or turns the USB AUDIO function off.
[USB AUDIO] slider	Adjusts the input level and output level of USB AUDIO.



### 3 Common section

Controller	Explanation
[WRITE] button	The WRITE screen appears. Saves a scene or tone.
[MASTER FX] button	The MASTER FX screen appears. If you hold down the [SHIFT] button and press this button, the MASTER EQ editing screen appears.
[ANALOG FILTER] button	Accesses the analog filter editing screen.
[MOTIONAL PAD] button	The MOTIONAL PAD screen appears.
[DAW CTRL] button	Lets you use this unit as a DAW controller.
[MENU] button	The MENU screen appears.
Display	Shows various information depending on operation.
FUNCTION knobs [E1]–[E6]	Turning a knob modifies the function or parameter value that is shown below in the screen. Pressing a knob has the same result as a button operation.
[TEMPO] button	The TEMPO screen appears. You can set the tempo by repeatedly pressing the button at the desired interval.
[SHIFT] button	Accesses the corresponding edit screen when pressed together with another button.
[VALUE] dial	Changes a value. If you hold down the [SHIFT] button and turn the dial, the value changes more greatly.
[DEC] [INC] buttons	Changes a value. If you press one of these buttons while holding down the other, the value changes more rapidly. If you press one of these buttons while holding down the [SHIFT] button, the value changes more greatly.
Cursor [▲] [▼] [◀] [▶] buttons	Move the cursor position up/down/left/right. These buttons also switch between screens.
[EXIT] button	This button returns to the previous screen or closes the open window.
[ENTER] button	Used to confirm a value, execute an operation, or view lists or other items.

### 4 Scene section

Controller	Explanation
[SCENE SELECT] button	The SCENE SELECT screen appears. Here you can select a scene.
[SCENE CHAIN] button	The SCENE CHAIN screen appears. This lets you recall scenes in a specified order.
[ZONE VIEW] button	The ZONE VIEW screen appears. Here you can check the state of each zone.
[SINGLE TONE] button	Recalls a piano sound to zone 1. Zones other than 1 are turned off. <b>NOTE</b> Note that when you press this button, unsaved scene settings are lost.

### 5 OSC (Oscillator) section

Controller	Explanation
[TYPE] knob	Specifies the OSC type.
[VALUE] knob	Lets you make OSC-related settings.
[PARAM] button	Accesses the OSC setting screen of the TONE EDIT ZOOM screen.

### 6 FILTER section

Controller	Explanation
[CUTOFF] knob	Specifies the cutoff frequency of filter.
[RESONANCE] knob	Specifies the resonance of filter.
[FILTER TYPE] button	Specifies the type of filter.
[PARAM] button	Accesses the FILTER setting screen of the TONE EDIT ZOOM screen.

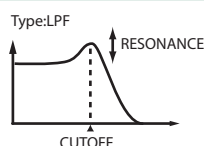

### 7 ENV/AMP section

Controller	Explanation
[PITCH ENV] button	Use the [A] [D] [S] [R] knobs to edit the pitch envelope (time-varying change in pitch).
[FILTER ENV] button	Use the [A] [D] [S] [R] knobs to edit the filter envelope (time-varying change in cutoff frequency).
[AMP ENV] button	Use the [A] [D] [S] [R] knobs to edit the amp envelope (time-varying change in volume).
[A] knob	Specifies the attack time of the envelope.
[D] knob	Specifies the decay time of the envelope.
[S] knob	Specifies the sustain level of the envelope.
[R] knob	Specifies the release time of the envelope.
[AMP LEVEL] knob	Adjusts the volume.
[PARAM] button	Accesses the TONE EDIT screen. The screen that appears depends on the PITCH, FILTER, or AMP parameters that are selected.

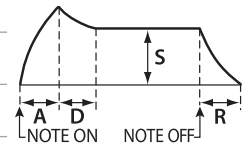

### 8 EFFECTS section

Controller	Explanation
[TYPE] knob	Specifies the MFX TYPE of the selected zone.
[DEPTH] knob	Specifies the MFX DEPTH of the selected zone.
[PARAM] button	Accesses the MFX screen of EFFECTS EDIT.

### 9 Sequencer section

Controller	Explanation
TONE CATEGORY buttons [1]–[16]	Select tones in each category. Depending on the situation, these buttons are also used for other things such as TR-REC input or as a selector for the SCENE CHAIN function.
[■STOP] button	Stops pattern playback or recording, or stops playback of the group or song.
[▶PLAY] button	Plays the pattern, group, or song.
[●REC] button	Enters the record-standby condition.
[TR-REC] button	Enables TR-REC. (p. 89)
[PATTERN] button	The PATTERN screen appears.
[GROUP] button	The GROUP screen appears.
[SONG] button	The SONG screen appears.
[RHYTHM PATTERN] button	The RHYTHM PATTERN screen appears.

### 10 Pad section

Controller	Explanation
[HOLD] button	Turns hold on/off (allowing the sound to continue even after you release the pad).
[BANK] button	Switches the pad bank.
[CLIPBOARD] button	Lets you move or copy a sample from one pad to another.
[PAD MODE] button	Specifies the functions that are assigned to the pads. Hold down the [SHIFT] button and press this button to access the edit screen for the currently selected pad mode and related screens.
[SAMPLING] button	Lets you sample.
Pads [1]–[16]	Play the samples assigned to each pad. You can make pad mode settings to assign various functions to the pads.

## Rear Panel (Connecting Your Equipment)

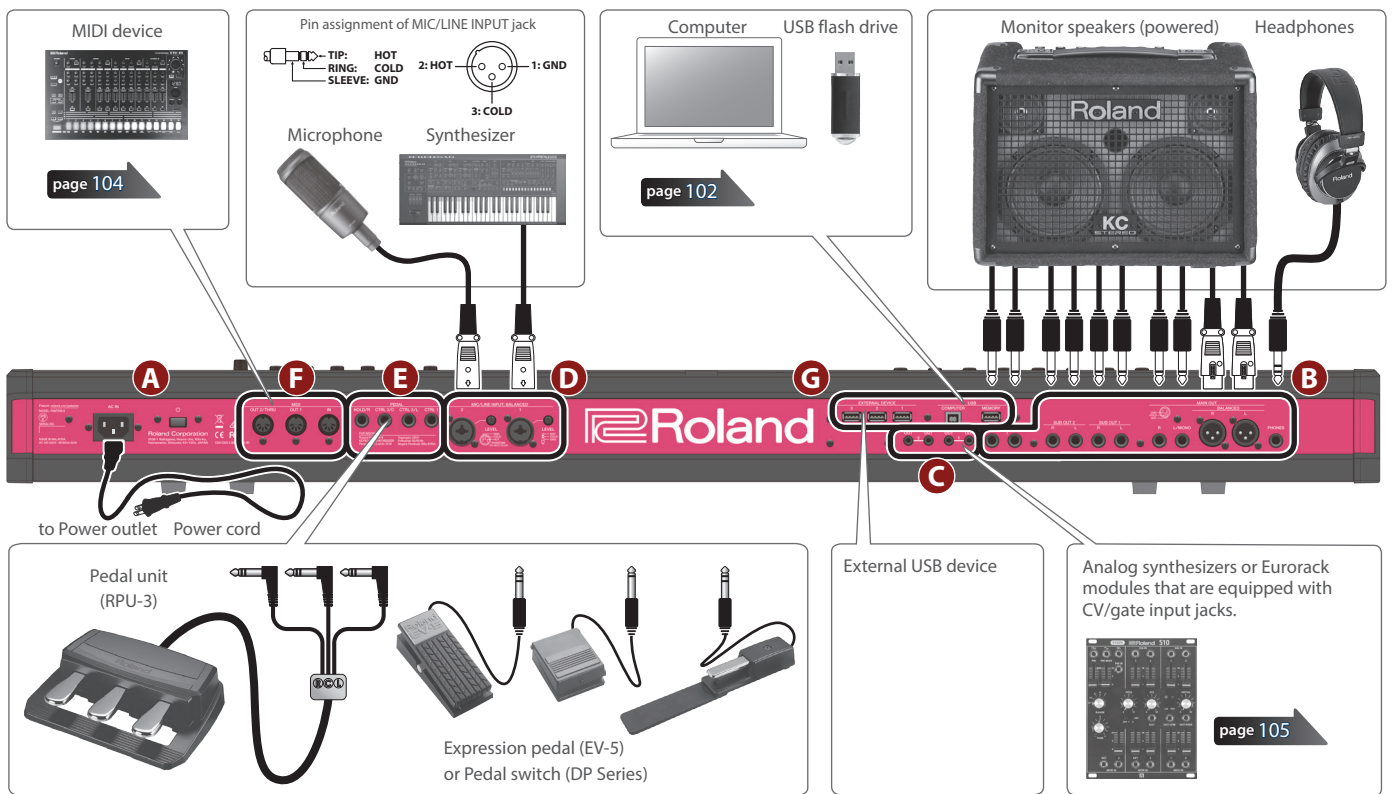

\* To prevent malfunction and equipment failure, always turn down the volume, and turn off all the units before making any connections.

### A Power Supply

Controller	Explanation
[ON] switch	This turns the power on/off.
AC IN jack	Connect the included power cord to this connector. * To prevent malfunction and equipment failure, always turn down the volume, and turn off all the units before making any connections.

### B OUTPUT jack

Controller	Explanation
PHONES jack	You can connect a set of headphones here. Even if headphones are connected, an audio signal is sent from the OUTPUT jacks and BALANCED OUT jacks.
MAIN OUT jacks (L, R) (Balanced)	These are balanced output jacks for audio signals. Connect them to your mixer. 
MAIN OUT jacks (L/MONO, R)	These are output jacks for audio signals. Connect them to your amp. If you're outputting in mono, connect the L/MONO jack.
SUB OUT 1 jacks (L, R)	These are output jacks for sub-out audio.
SUB OUT 2 jacks (L, R)	These are output jacks for sub-out audio.
ANALOG FILTER OUT jacks (1, 2)	These output the sound that has passed through the analog filter section.

### C CV/GATE jacks

Controller	Explanation
GATE OUT jacks (1, 2)	These jacks output note-on/off. They output +5 V. Depending on the settings, GATE OUT 2 can also be used as CV OUT.
CV OUT jacks (1, 2)	These jacks output pitch. If you've specified a transpose or octave shift setting, the voltage changes according to the setting. These jacks support OCT/V (Hz/V is not supported).

### D INPUT jack

Controller	Explanation
MIC/LINE INPUT jacks (1, 2) (Balanced)	Connect a mic, audio device, or external synthesizer etc. to these jacks. The MIC/LINE INPUT jacks support XLR-type and TRS-type plugs. The XLR-type connections support 48 V phantom power, allowing you to connect condenser mics that use phantom power (phantom power supply: DC 48 V, 10 mA Max). Stereo input via a TRS plug is not supported.
LEVEL knobs (1, 2)	Adjusts the input level of the MIC INPUT jack.

### E FOOT PEDAL jack

Controller	Explanation
PEDAL jacks (CTRL 1, CTRL 2/L, CTRL 3/C, HOLD/R)	If you connect a pedal switch (sold separately: DP series) to the HOLD/R jack, you can use it as a damper pedal. You can also assign various functions to the pedals that are connected to the CTRL 1, CTRL 2/L, and CTRL 3/C jacks. * Use only the specified expression pedal. By connecting any other expression pedals, you risk causing malfunction and/or damage to the unit.

### F MIDI jack

Controller	Explanation
MIDI connectors (IN, OUT 1, OUT 2/THRU)	Used for connecting external MIDI devices and for transmission of MIDI messages. The OUT 2/THRU connector's function can be switched to operate either as MIDI THRU or as MIDI OUT.

### G USB port

Controller	Explanation
USB MEMORY port	Use a commercially available USB flash drive. However, we cannot guarantee that all commercially available USB flash drives will work.
USB COMPUTER port	Connect this to your computer to transfer performance data and audio signals.
EXTERNAL DEVICE jacks (1, 2, 3)	Connect these to an external USB device.

# Basic Operation

Here we explain basic operation of the buttons and knobs used to operate the FANTOM.



## Editing a Value

Use the following methods to modify a setting's value.

### [INC] [DEC] Buttons

Press the [INC] button to increase the value; press the [DEC] button to decrease the value.

Purpose	Operation
Modifying a value continuously	Hold down the [DEC] button or [INC] button.
Modifying a value rapidly	Hold down the [INC] button and press the [DEC] button. Hold down the [DEC] button and press the [INC] button.
Modifying a value more greatly	Hold down the [SHIFT] button and press the [DEC] button. Hold down the [SHIFT] button and press the [INC] button.

### [VALUE] Dial

Turn the dial clockwise to increase the value, or counter-clockwise to decrease the value.

Purpose	Operation
Modifying a value more greatly	Hold down the [SHIFT] button and turn the [VALUE] dial.

## Display (Touch Panel)

You can directly touch or drag on/off icons, knobs, and sliders in the screen to switch them on/off or change their value.

Examples of on/off icons

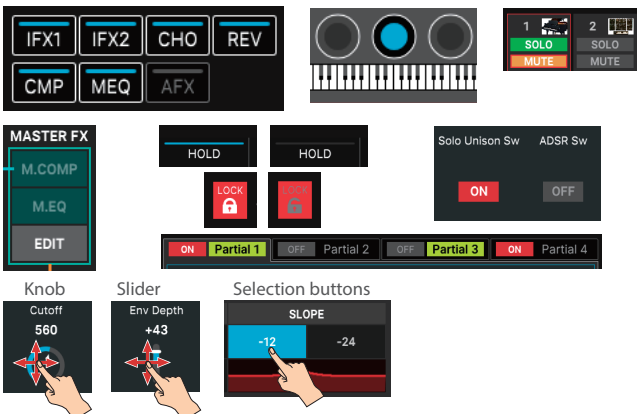

Drag up or right	Value increases
Drag down or left	Value decreases.

## NUMERIC Window

If you hold down the [SHIFT] button and press the [ENTER] button, the numeric window appears. This is a convenient way to directly enter a numeric parameter value from the touch panel.

You can also open a window by touching a <NUMERIC> icon in the FUNCTION area below the display.

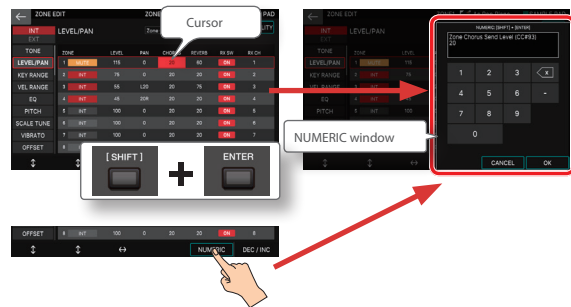

### NOTE

Some parameters don't support numeric input.

## List Window

You can open a list window by directly touching a pulldown menu in the screen, or by moving the cursor to a parameter and pressing the [ENTER] button. Use the [E4] knob to select the value.



## Moving the Cursor

Multiple setting items (parameters) or selection items are shown in a single screen or window. To edit them using the [INC] / [DEC] buttons or the [VALUE] dial, move the cursor to the location of the item you want to edit.

The shape of the cursor differs depending on the screen or the parameter. (For example, it could have a red or blue border, or be highlighted in red or yellow, etc.) You can move the cursor in the following ways.

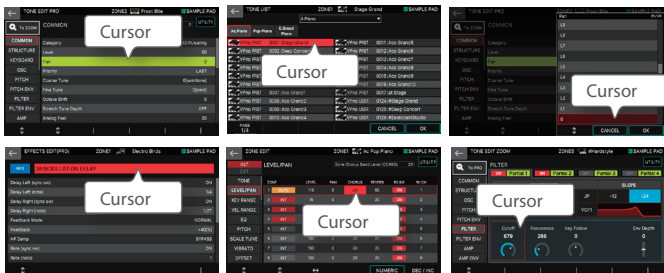

## Cursor [▲] [▼] [◀] [▶] Buttons

Press a cursor button to move the cursor in the corresponding direction.

Purpose	Operation
Moving the cursor continuously	Hold down the cursor button.
Moving the cursor rapidly	While continuing to hold down one cursor button, hold down the cursor button of the opposite direction.

## Display (Touch Panel)

By directly touching a parameter value, knob icon, or slider icon in the screen, you can move the cursor to that location.

### NOTE

Some icons do not move the cursor.

## Confirming or Canceling the Value

### [ENTER] Button

Use this button to confirm a value or execute an operation. When you move the cursor to a tone or parameter and press the [ENTER] button, a list appears, allowing you to change the setting.

### [EXIT] Button

This button returns to the previous screen, or closes the open window.

## Display (Touch Panel)

Indication such as <OK> or <SELECT> shown in a confirmation screen have the same operation as the [ENTER] button, and <EXIT> has the same operation as the [EXIT] button.



Use <CANCEL> to cancel an operation, or to return an edited value to its original value and exit the screen.

## [SHIFT] Button

This is used in conjunction with other buttons.

By holding down the [SHIFT] button and pressing another button, you can move to the related edit screen for the button that you pressed (shortcut).

Shortcut	Explanation
[SHIFT] + WHEEL 1, 2	The setting screen for the corresponding controller appears.
[SHIFT] + S1, S2, S3	The Assign setting screen appears.
[SHIFT] + [ASSIGN] 1, 2	The Key Range setting screen appears.
[SHIFT] + [SPLIT/KEY RANGE]	The Key Range setting screen appears.
[SHIFT] + [PAD MODE]	The setting screen or related screen for the currently selected pad mode appears.

## FUNCTION Knobs [E1]–[E6]

These knobs perform the functions that are assigned to them in each screen, such as editing parameters or scrolling lists or tabs. By pressing a knob, you can edit a value with a button-like operation.

Knob border color	Explanation
red	Turn the knob to scroll the tab or parameter cursor.
blue	Turn the knob to edit the value of the corresponding parameter. For a parameter whose value is "on/off," you can press the knob to switch the parameter on/off.
green	Press the knob to execute or cancel a function, or to move to another page.
unlit	No function is assigned to a knob in this state.

## Knob and Slider Operations

When you use a knob or slider to edit a setting, the edited parameter and its value are shown in a popup screen.

The popup screen closes automatically after a time.

Some parameters don't show a popup screen.

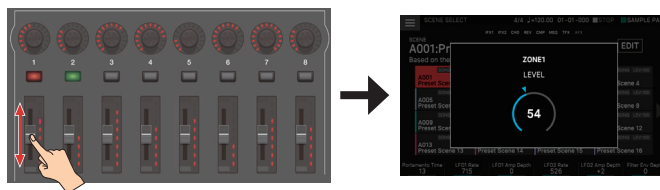

## [MENU] Button

Allows you to make detailed settings for a function, or system settings. You can also access the menu screen by touching the ≡ icon located in the upper left of the SCENE SELECT screen.

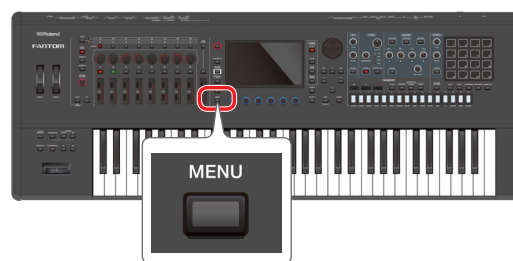
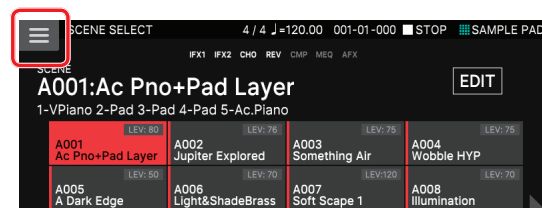

### Operating procedures in this manual

On this unit, operations such as "editing a value," "moving the cursor," "setting/cancelling a value," or "moving to a screen" can be performed on multiple ways, as explained earlier. (For example, "button operations," "touch panel operations," "dial operations," etc.)

To prevent the explanations from becoming cluttered, subsequent explanations in this document use a simplified form such as "move the cursor to \_\_\_ and edit the value" or "choose \_\_\_," rather than describing all of the possible methods for doing so. For actual operation, you can use your preferred method of the various multiple methods described above.

## Operations in the Display

This unit's display is a touch panel; you can perform various operations by directly touching the display. There are many screens, but here we explain the typical screen operations.

- A light touch with your finger is sufficient to operate the touch panel. The touch panel might be damaged if you press it strongly, or if you press it with a hard object. Do not use excessive force, and use only your finger to operate it.
- Text enclosed in square brackets [ ] indicates a button or knob on the panel. Text enclosed in angle brackets < > indicates a button, knob, or icon in the display that you can "touch." Icons such as "OK" or "CANCEL" that are shown in the lower part of the display and respond to the [E1]–[E6] knobs as well as to touch in the display are expressed in this document using a form such as "Select [E6] OK."

### MEMO

If you lose track of which screen you're in, you can return to the SCENE SELECT screen by pressing the [EXIT] button several times or by pressing the [SCENE SELECT] button.

By touching the <←> icon in the upper left of the screen, you can return to the previous screen.

## SCENE SELECT Screen

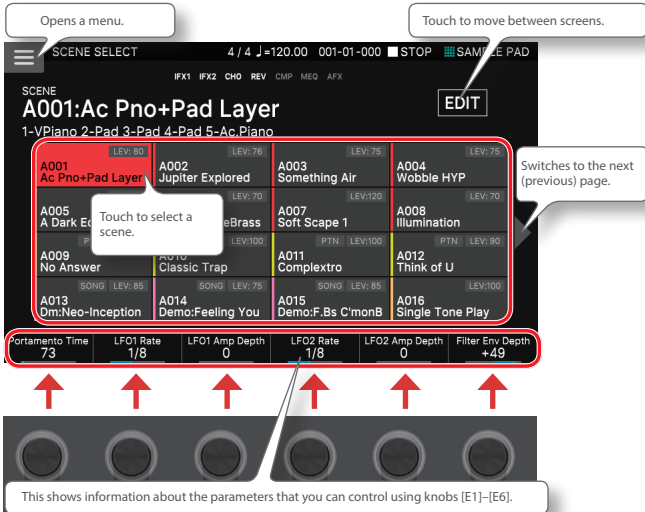

## TONE EDIT Screen

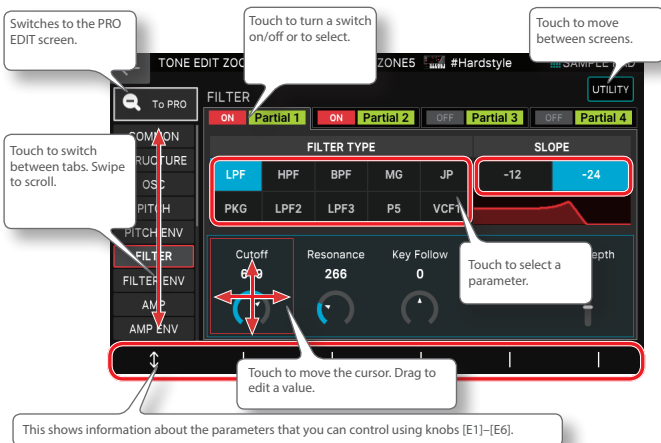

## ZONE VIEW Screen

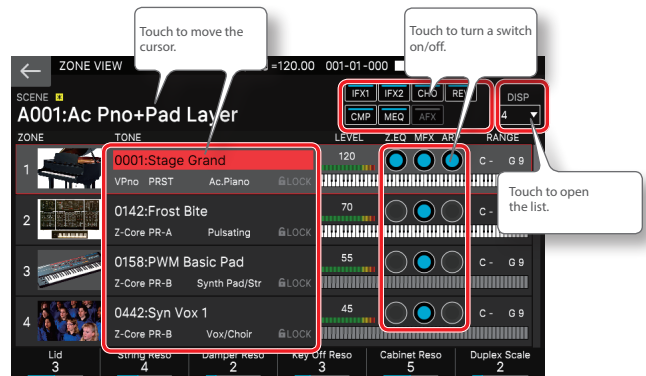

## MENU Screen

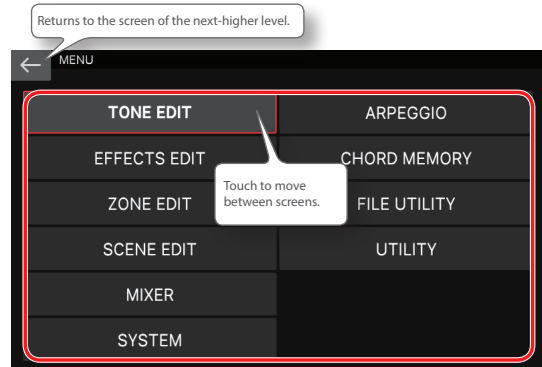

## RENAME Screen

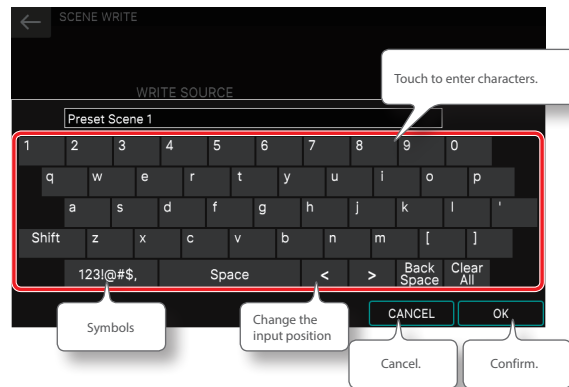

## REC STANDBY Screen

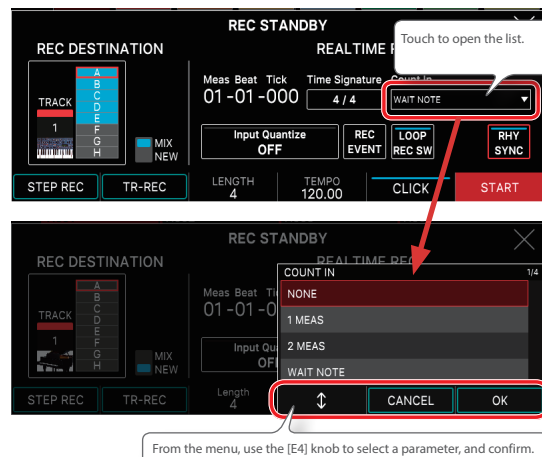

# An Overview of FANTOM

## Basic Structure

Broadly speaking, this unit consists of four sections: controller, synthesizer, sequencer, and sampler.

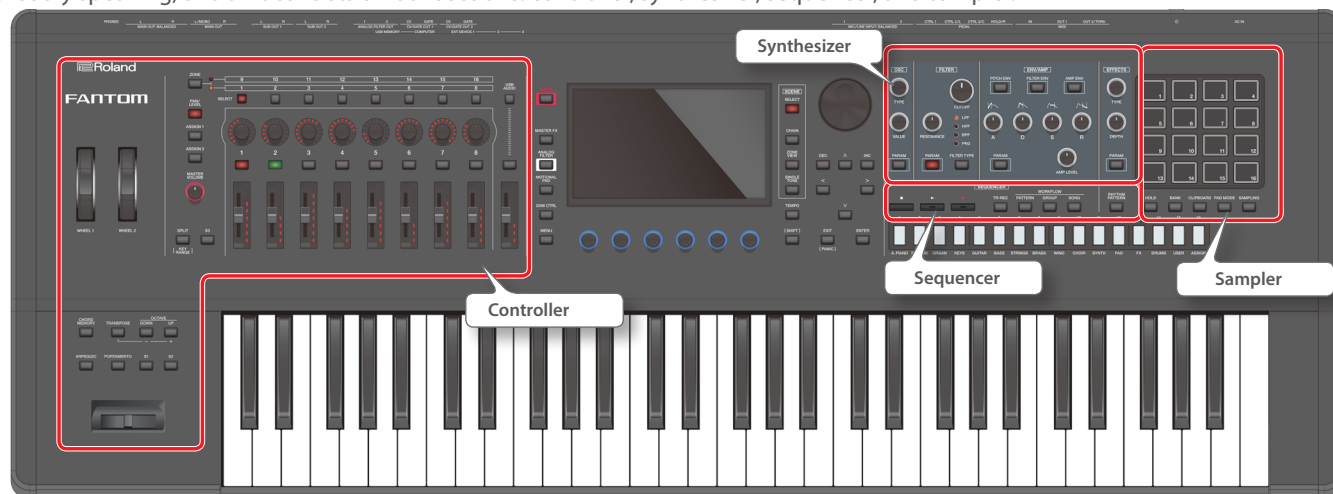

## Synthesizer

This is the section that generates and modifies sound. In response to the performance data from the controller, it produces an audio signal that is output from the OUTPUT jacks and the PHONE jack.

This is also called the sound engine section.

The FANTOM provides numerous tones that you can use to perform and produce songs. These tones are organized by category, allowing you to quickly select and play the tone you want. When you find a tone that you like, you can use the knobs and controllers of the synthesizer section to modify the tone in real time while you play it.

To play a tone, you assign it to a container called a "zone." The FANTOM provides 16 zones so that you can play multiple tones simultaneously.

- You can play a single tone using just one zone (Single)
- You can play multiple tones together using multiple zones (Layer)
- You can play separate tones with your right and left hands (Split)

This supports a variety of performing styles depending on your situation.

When you're producing a song, you can take full advantage of all 16 zones for multipart performance.

Settings for each zone together with the song data is managed collectively in units called "scenes."

## Sequencer

The sequencer section lets you record your performance as MIDI data and play it back. You can record synchronize data to tracks that are paired with the zones, and create patterns. You can combine patterns to create groups, and place groups in a desired order to create a song.

### Track

This is a container for patterns. Tracks have a one-to-one relationship with zones. You can use all 16 tracks to make every zone play independently.

### Pattern

This is a unit of sequence data that records performance data for an individual tone. There can be up to eight patterns in one track. You can record up to 32 measures in one pattern. Realtime recording, step recording, and TR-REC are supported.

### Group

This records a combination of patterns for each track. You can create up to 16 groups in one scene.

### Song

By placing groups in the desired order you can create a "song" that records that order. You can create one song in one scene.

## Sampler

The sampler section lets you audio-record (sample) the sound of your keyboard performance or the input sound from an audio device or mic. The recorded sample can be played by pressing a pad.

### Sample

This is a piece of sampled sound. For each sample, you can specify looping and other settings, and assign it to a pad.

## Controller

This includes the keyboard, pads, pitch bend/modulation lever, wheels, panel knobs, sliders, and pedals connected to the rear panel. When you perform a performance operation such as pressing or releasing a key or pressing the damper pedal, the operation is converted into a MIDI message and transmitted to the sound engine and to an external MIDI device.

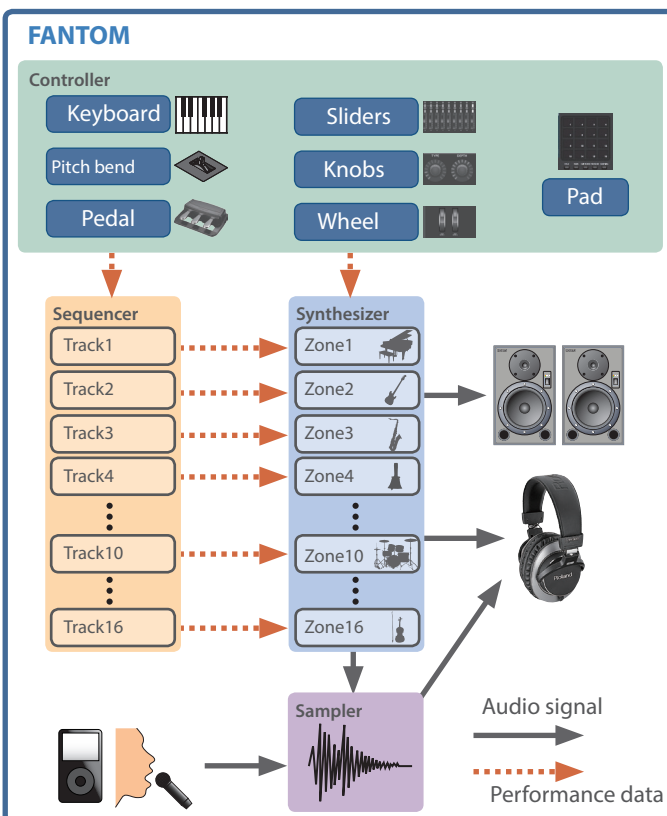

## Units of Sound

### TONE

The “tone” is the smallest unit of sound. There are three types of tone, depending on the sound engine used by the tone. The FANTOM produces tones using three sound engines: Z-Core, Drum, and VPno.

Type	Explanation
<b>Z-Core</b> (ZEN-Core Tone)	These are tones that produces the sound of a single instrument such as piano, organ, or synth. A single instrumental sound is created by combining four partials (PWM waves or VA oscillators). These tones consist of the ZEN-Core sound engine together with effects (MFX+EQ).
<b>Drum</b> (Drum Kit Tone)	These are tones that contain a collection of multiple percussion instruments, and are called “drum kits.” A drum kit produces different percussion instrument sounds depending on the key (note number) that you play. These tones consist of the ZEN-Core sound engine together with effects (MFX+EQ+COMP). *COMP applies only for the one specified zone (the zone specified by Drum Kit Comp Zone).
<b>VPno</b> (V-Piano Tone)	These are V-Piano tones. They can be used only in ZONE 1. These tones consist of the V-Piano Technology sound engine together with effects (MFX).

#### What is the ZEN-Core engine?

This is a new synthesizer sound engine that was developed using cutting-edge technology based on VA technology developed for the V-Synth. It features analog-like response speed and high resolution, allowing you to create a wide range of high-quality sounds. It is also fused with the PCM sound engine developed by Roland for many years, supporting even more sophisticated sound design.

#### What is the V-Piano Technology sound engine?

This is a dedicated sound engine for acoustic piano which reproduces a piano from its structure.

#### Type : Z-Core

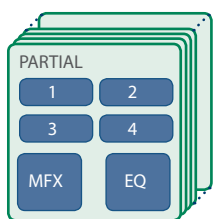

PRESET TONE  
USER TONE

- You can edit a tone and then save it as a user tone.
- You can use tone category buttons [1]–[16] to select tones by category, or select them by Bank + number.

#### Type : Drum

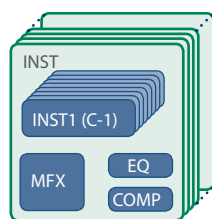

PRESET DRUM KIT  
USER DRUM KIT

#### Type : VPno

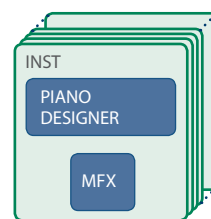

PRESET TONE  
USER TONE

### ZONE

This is a container for playing a tone.

To play a tone, you assign it to a zone. For each zone, you can specify whether it is connected to the keyboard, and make settings such as its key range, volume, pan, and controller reception.

There are 16 zones; by combining zones you can create sounds that consist of multiple tones, or create foundational performance (tone) settings for each song.

You can also use specific zones to control an external sound module (EXT ZONE) instead of the internal sound engine.

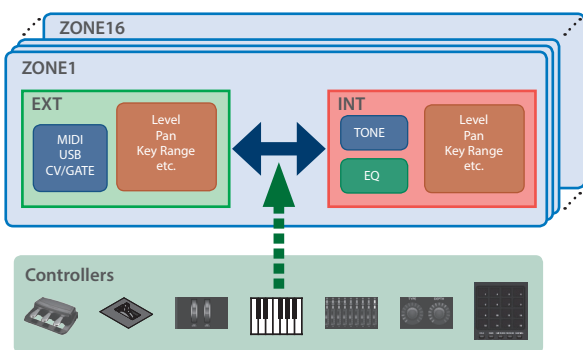

### SCENE

A scene contains a favorite performing state, including settings for each zone (tone, MFX, volume, etc.), settings common to all zones (Reverb, Chorus, IFX, Analog Filter, etc.), and sequence data for each zone.

You can store an idea for a song or phrase as a scene, and manage scenes by switching them for each song.

You can freely recall saved scenes in the SCENE SELECT screen that appears after startup.

By using the SCENE CHAIN function you can place and recall scenes in the order of the songs that you'll be playing live, or collect frequently-used scenes for easy recall (p. 60).

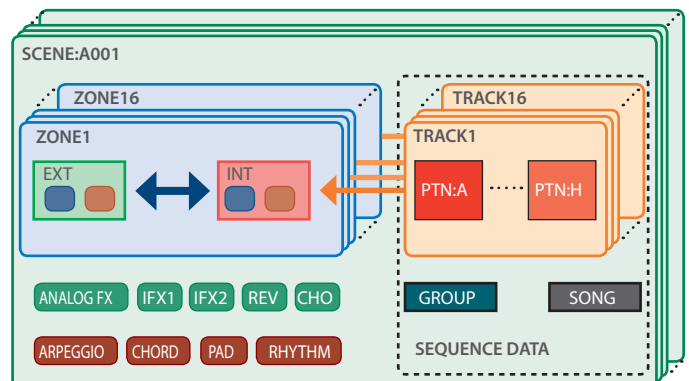

## About the Effects

The FANTOM is equipped with the following built-in effects, and settings can be made independently for each.

Effect type	Effect	Explanation
Tone effects	Multi-effect (MFX)	This is a general-purpose multi-effect that transforms the sound itself, giving it an entirely different character. You can choose from 90 types as appropriate for your needs. These types include single effects such as distortion or flanger, as well as a variety of other types. Each tone has settings for one multi-effect.
	DRUM KIT COMP	A drum kit can use six compressor units. These can be assigned to individual drum instruments. A drum kit can be assigned to all zones, but the six compressor units for a drum kit apply only to the specified one zone (the zone specified by Drum Kit Comp Zone).
	PARTIAL EQ	This is an equalizer that can be applied to each partial of tone. You can independently adjust the high, mid, and low-frequency ranges.
	KIT PARTIAL EQ (KIT PTL EQ)	This is an equalizer that can be applied to each drum inst. You can independently adjust the high, mid, and low-frequency ranges.
Scene (Zone) effects	Zone EQ	This is an equalizer that can be applied to each zone. You can independently adjust the high, mid, and low-frequency ranges.
	Chorus	Chorus is an effect that adds depth and spaciousness to the sound. This effect is common to all zones.
	Reverb	Reverb is an effect that produces the reverberation that is characteristic of sounds heard in a hall. This effect is common to all zones.
	Insert effect1 (IFX1)	These are general-purpose insert effects that can transform the sound itself, giving it a completely different character.
	Insert effect2 (IFX2)	There are 90 types, and you can select and use the type that's appropriate for your purpose. Use these when you want to apply a further effect in addition to the multi-effect. The insert effects provide two independent effect units, IFX 1 and 2, and you can make routing settings to connect IFX 1 and 2 in series or in parallel. These effects are common to all zones.
	Analog Filter	This provides two independent units of analog filter + overdrive. They can be applied to the desired zone output, or to the mixed master output. Highly flexible routing is provided, so that the output of the analog filter can be returned to main out, or output from the Analog Out jack. This effect is common to all zones.
System effects (MASTER FX)	Mastering Comp	The mastering compressor compresses sound that is louder than the specified volume level, making the volume more consistent. It can be adjusted independently for the high, mid, and low-frequency regions.
	Mastering EQ	The mastering EQ is an equalizer that is applied to the entire sound engine of the FANTOM. You can independently adjust the high, mid, and low-frequency ranges.
System effects (Effects applied to the AUDIO INPUT jack)	Low Cut	This cuts the unwanted low-frequency portion from the input sound of the AUDIO INPUT jacks.
	Input EQ (EQ)	This equalizer is applied to the input sound from the AUDIO INPUT jacks.
	Input Reverb (REV)	This reverb is applied to the input sound from the AUDIO INPUT jacks.

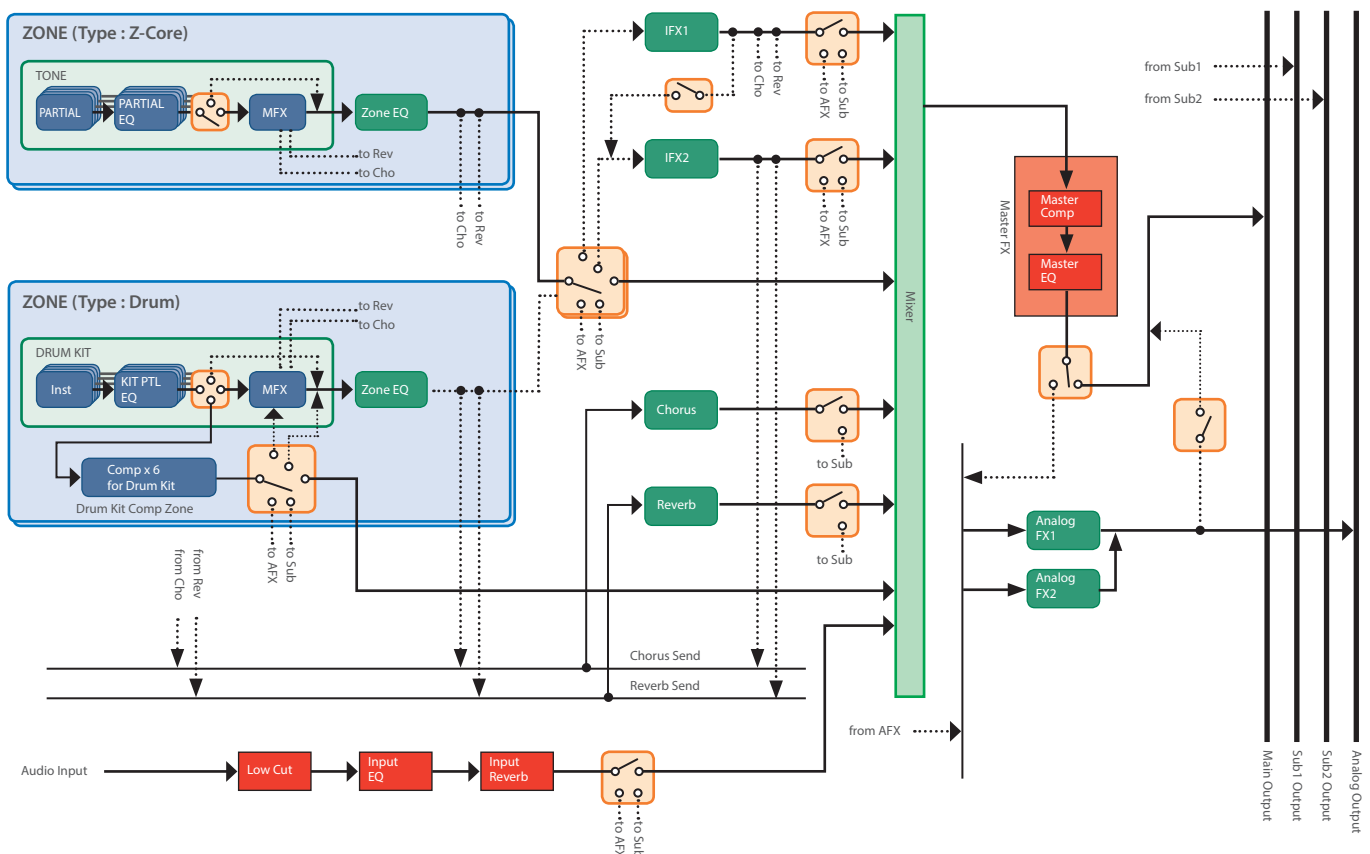



## About Memory

“Memory” refers to locations where scenes, tones, and other settings are stored.

Memory can be categorized according to its function into three types: the temporary area, rewritable memory (user memory, system memory, internal storage, and USB flash drive), and non-rewritable memory (preset memory).

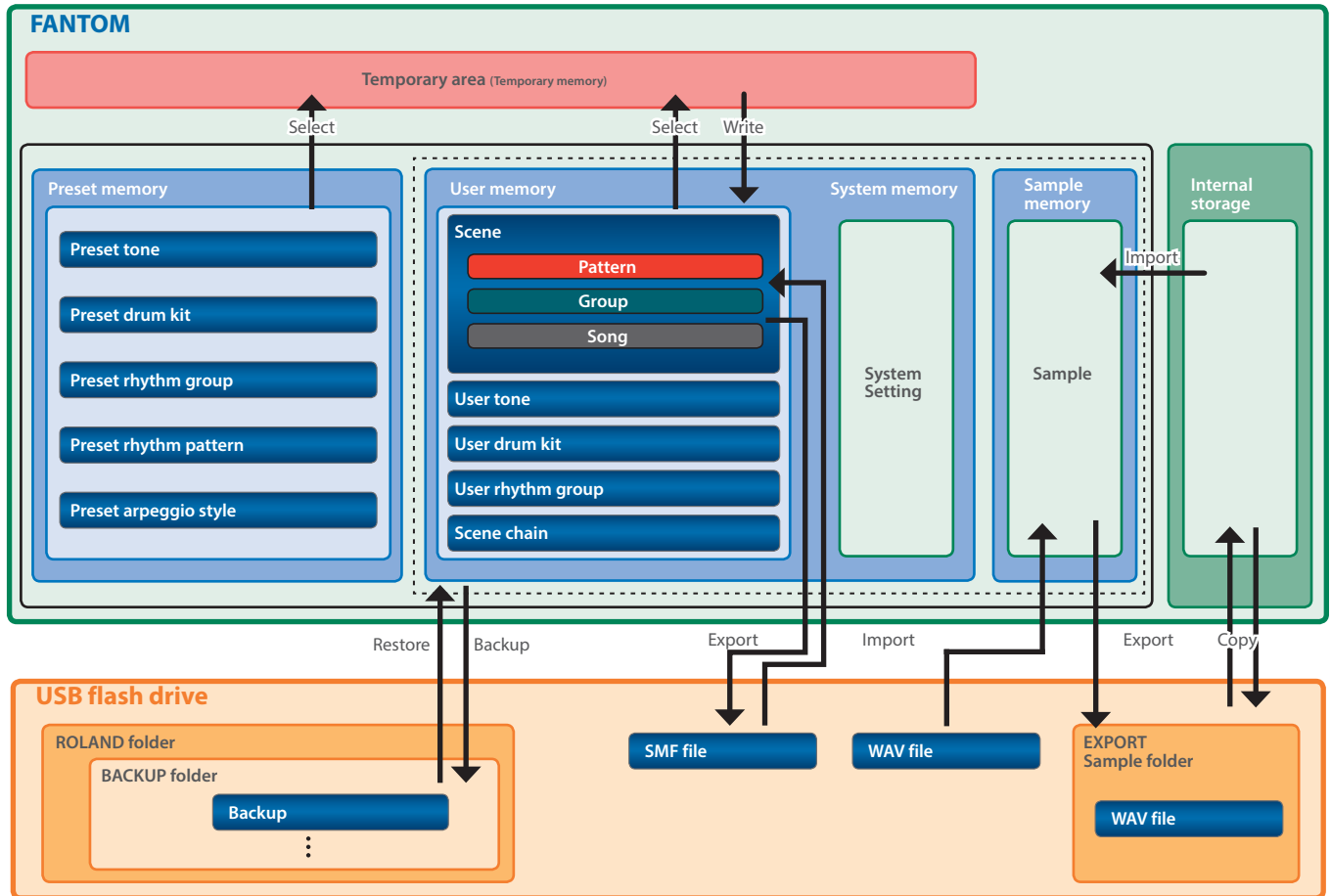

### Temporary memory

#### The temporary area

This temporarily stores the data for the scene, tones, and sequence data that you selected using the panel buttons.

When you perform, the sounds are produced according to the settings of the temporary area. When you edit scenes, tones, or sequence data, your changes affect the data that has been recalled into the temporary area; they do not directly modify the data of that memory.

Settings in temporary memory are not permanent; they will be lost when you turn off the power or recall other settings.

If you want to keep the settings that are in temporary memory, you must save them to user memory or a USB flash drive.

### Rewritable memory

#### System memory

This area stores system settings for the entire FANTOM. To save system parameters, execute the system save operation (p. 112).

#### User memory

This memory stores data that is saved in the FANTOM. To store data, execute the appropriate Save operation.

- Saving a scene. (p. 44)
- Saving a tone. (p. 48)
- Saving a rhythm pattern group. (p. 34)
- Creating a chain set. (p. 61)

#### Sample memory

This memory stores samples in the FANTOM. Samples are saved automatically when you stop sampling or when you exit the WAVE EDIT screen.

### Internal storage

This is storage memory inside the FANTOM. You can use the file utility functions to copy, delete, or move saved files between this storage and a USB flash drive.

### USB flash drive

- The user memory data and the system parameter settings can be backed up together to a USB flash drive (p. 108).
- SMF or WAV files can be imported into the FANTOM or exported from the FANTOM.

### Non-rewritable memory

#### Preset memory

Data in preset memory cannot be rewritten. However, you can call this data into the temporary area, modify the settings, and then save those modified settings in user memory.

# Getting Ready

## Placing This Unit on a Stand

Be careful not to pinch your fingers when setting up the stand. Place the instrument on the stand as follows.

\* When using the KS-10Z, ensure that the height of the unit is one meter or lower.

## If You're Using the FANTOM-6/FANTOM-7

If you want to place the FANTOM-6/FANTOM-7 on a stand, please use the KS-12 or KS-10Z stands manufactured by Roland.

\* The illustration shows the FANTOM-6.

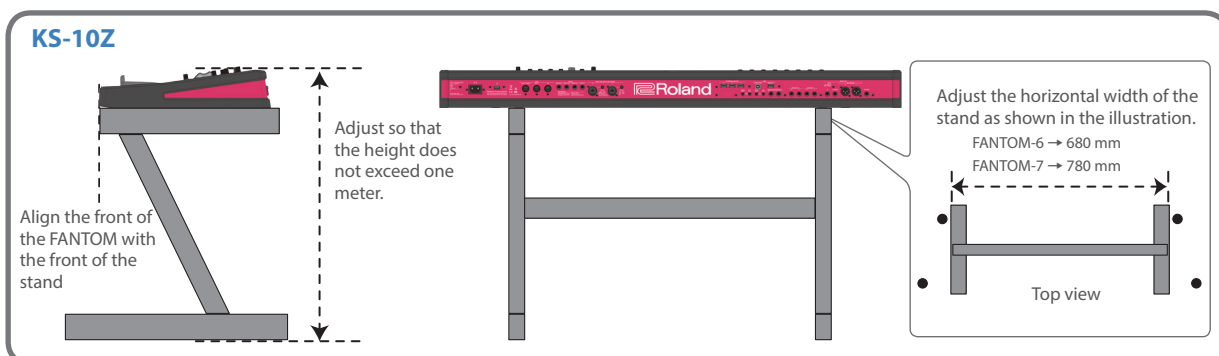
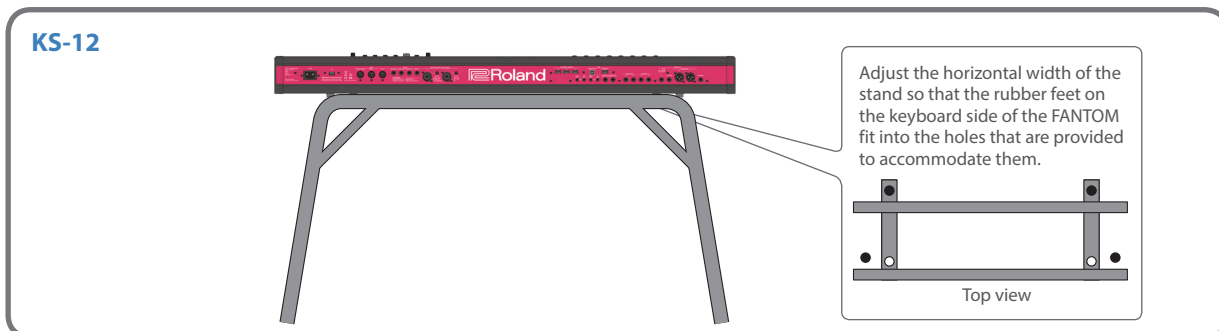

## If You're Using the FANTOM-8

If you want to place the FANTOM-8 on a stand, please use the KS-12, KS-10Z, or KS-G8B stands manufactured by Roland.

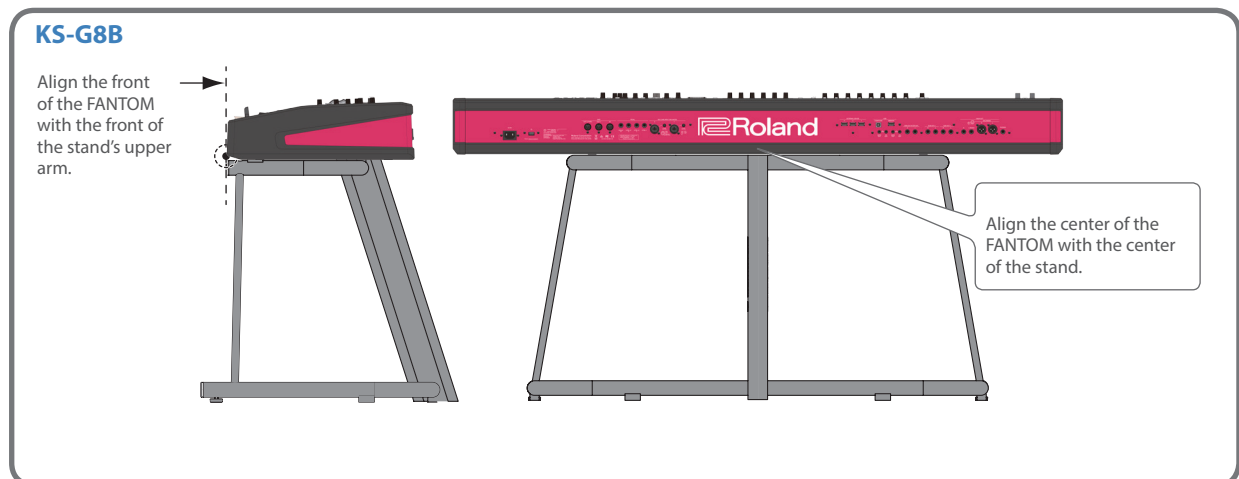
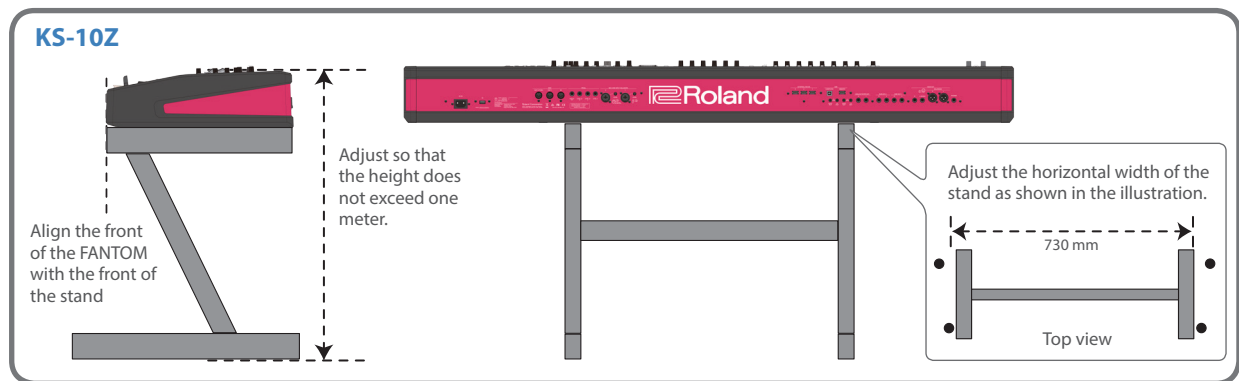
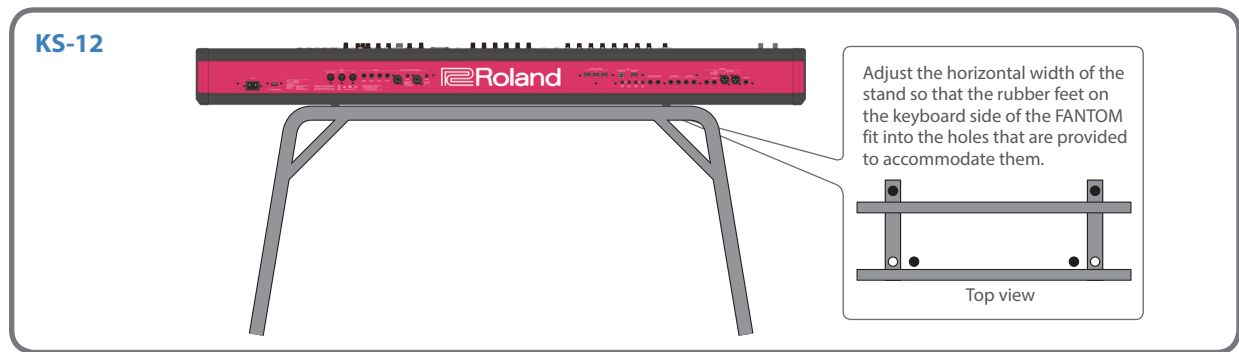

## Turning the Power On

Once everything is properly connected, be sure to follow the procedure below to turn on their power. If you turn on equipment in the wrong order, you risk causing malfunction or equipment failure.

### 1. Minimize the volume of this unit.

Also completely turn down the volume of any connected external devices.

### 2. Press the [ON] switch.

The unit is turned on, and the display's backlighting comes on.

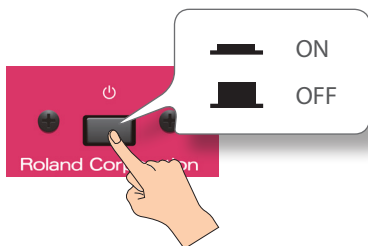

### 3. Turn on the power to connected external devices.

### 4. Adjust the volume of the connected external devices.

### 5. Adjust the volume of this unit.



## Turning the Power Off

### 1. Minimize the volume of this unit.

Also completely turn down the volume of any connected external devices.

### 2. Turn off the power of the connected external devices.

### 3. Press the [OFF] switch.

The unit is turned off.

#### NOTE

- Before turning the unit on/off, always be sure to turn the volume down. Even with the volume turned down, you might hear some sound when switching the unit on/off. However, this is normal and does not indicate a malfunction.
- If you need to turn off the power completely, first turn off the unit, then unplug the power cord from the power outlet.

## Making the Power Automatically Turn off After a Time (Auto Off)

The power to this unit will be turned off automatically after a predetermined amount of time has passed since it was last used for playing music, or its buttons or controls were operated (Auto Off function).

If you do not want the power to be turned off automatically, disengage the Auto Off function.

#### NOTE

- Unsaved data is lost when the power turns off. Any data that you want to keep must be saved in advance.
- To restore power, turn the power on again.

## Changing the Auto Off Setting

### 1. Press the [MENU] button.

The MENU screen appears.

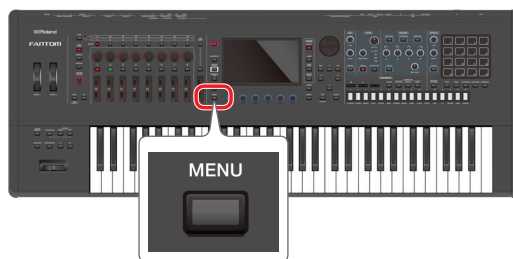

### 2. Touch <SYSTEM>.

The SYSTEM screen appears.

### 3. Touch <GENERAL>.

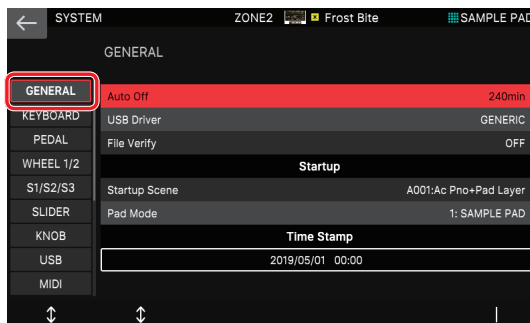

### 4. Select "Auto Off" and change the setting.

Parameter	Value	Explanation
Auto Off	OFF	The power will not turn off automatically.
	30min	The power will automatically turn off if no operation is performed for 30 minutes.
	240min (default)	The power will automatically turn off if no operation is performed for 240 minutes (four hours).

### 5. If you want to store the auto-off setting, press the [WRITE] button in the System screen.



When the save operation is completed, the indication "Completed" appears.

# 02: Performing

## Contents

---

### Selecting a Sound (SCENE/TONE) ..... 22

- ◇ **Selecting a Scene** ..... 22
    - Selecting a Bank ..... 22
    - Quick Edit ..... 22
  - ◇ **Selecting a Tone** ..... 23
    - Selecting Tones in a Category (Category Lock) ..... 23
    - Selecting Tones from a List ..... 23
- 

### Performing ..... 24

- ◇ **Playing One Tone in One Zone** (Single) ..... 24
  - ◇ **Layering Zones** (Layer) ..... 24
    - Selecting a Tone (Layer) ..... 25
  - ◇ **Dividing the Keyboard into Two Regions** (Split) ..... 25
    - Changing the Keyboard's Split Point ..... 25
    - Selecting a Tone (Split) ..... 25
  - ◇ **Playing Multiple Zones** ..... 26
    - Specifying the Range of Each Zone (KEY RANGE) ..... 26
- 

### Changing the Keyboard Settings ..... 27

- ◇ **Raising/Lowering the Key Range in Semitone Steps** (Transpose) ..... 27
- ◇ **Raising/Lowering the Key Range in Octaves** (Octave) ..... 27

# Selecting a Sound (SCENE/TONE)

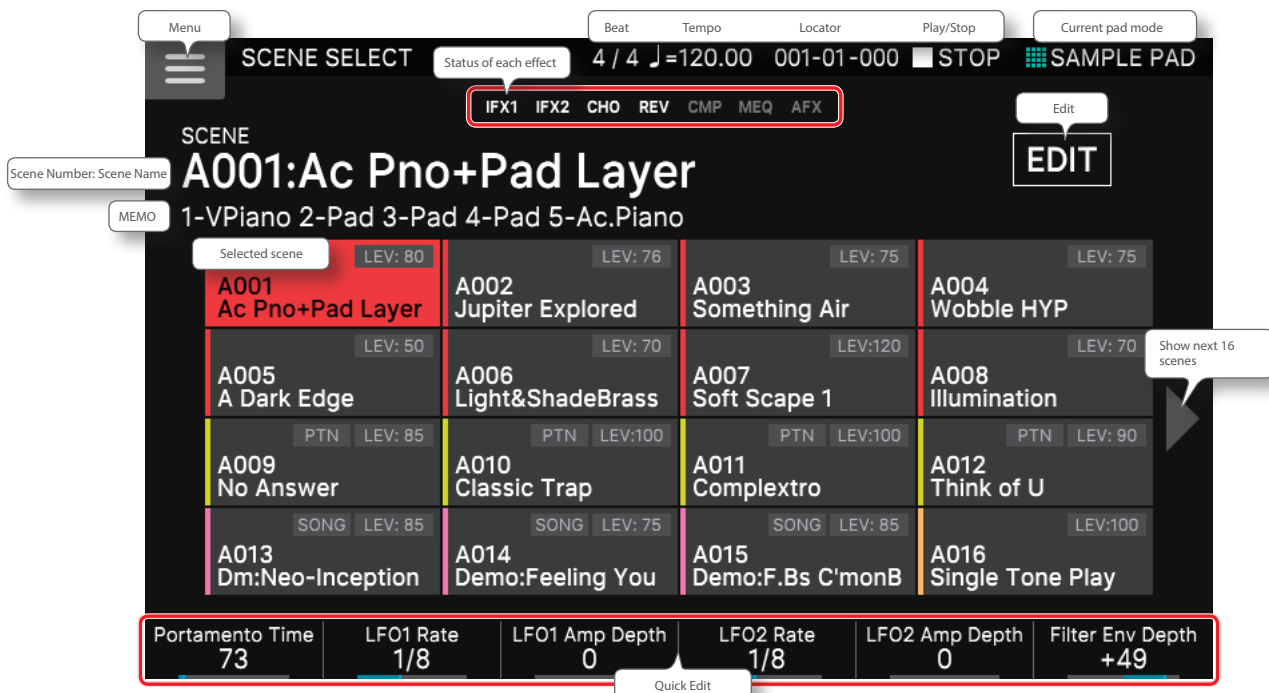

## Selecting a Scene

### 1. Press the [SCENE SELECT] button.



The SCENE SELECT screen appears.

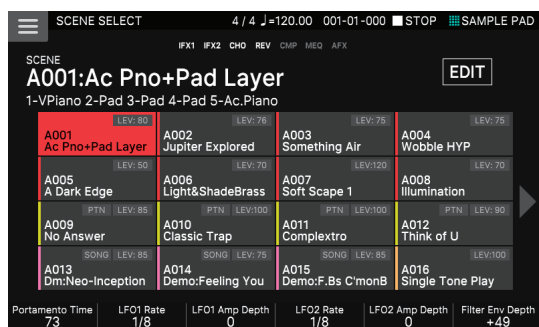

### 2. Touch a scene icon in the screen to select the desired scene.

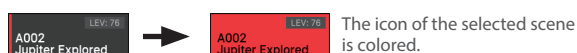

Sixteen scene icons are arranged in the screen as a 4 x 4 grid, and you can select one of these scenes. By touching the ◀ (▶) icon located at the left or right edge of the screen, you can choose from the previous (or next) 16 scenes.

## Selecting a Bank

Scenes are organized in “banks” of 128 scenes.

BANK A	A001–A128	BANK C	C001–C128
BANK B	B001–B128	BANK D	D001–D128

Here’s how to switch banks.

### 1. Press the [ENTER] button.

The BANK SELECT screen appears.

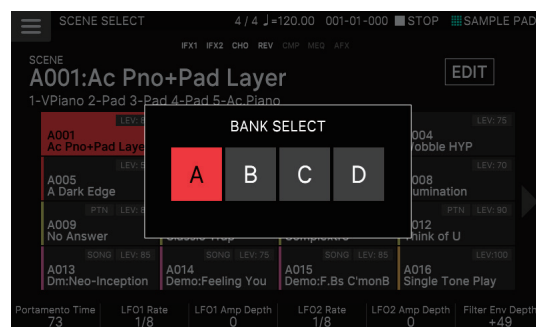

### 2. Select the desired bank.

## Quick Edit

In the SCENE SELECT screen and the ZONE VIEW screen, you can use FUNCTION knobs [E1]–[E6] located below the display to quickly edit the sound. (Quick Edit)

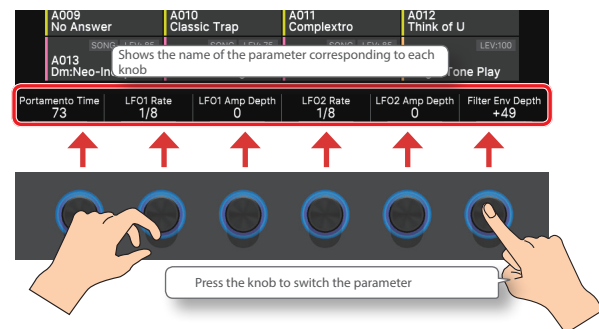

- The editable parameters differ depending on the tone type.
- Depending on the tone type, you can press a knob to switch parameters.
- These quick edit operations edit the parameters of the current zone. If the tone type is “Drum,” they edit the parameters of the instrument that you specify by pressing a key on the keyboard.

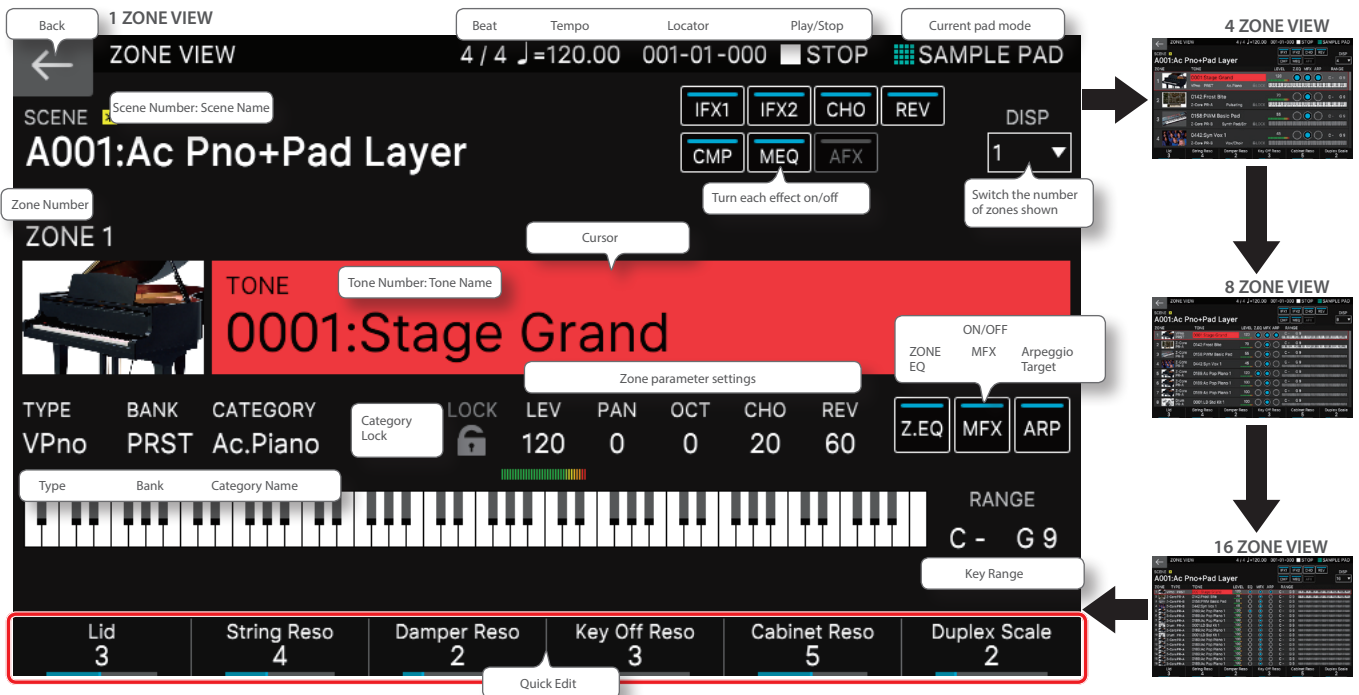

## Selecting a Tone

1. Press the [ZONE VIEW] button.



The ZONE VIEW screen appears.

Each time you press the [ZONE VIEW] button, the configuration alternates in the order of 1 ZONE → 4 ZONE → 8 ZONE → 16 ZONE.

2. Press a ZONE SELECT button [1]–[8] to select the zone that you want to control.  
To select zones 9–16, use the [ZONE 1-8/9-16] button to switch groups, and then press a ZONE SELECT [1]–[8] button.
3. Press a tone category button [1]–[16] to select the type (category) of tone.
4. Move the cursor to the tone name (number), and use the [VALUE] dial or the [INC][DEC] buttons to select a tone.

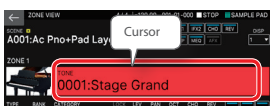

## Selecting Tones in a Category (Category Lock)

If you move the cursor to the lock icon and use the [VALUE] dial or the [DEC][INC] buttons to set it to “UNLOCK,” you can switch tones across categories.

If this is set to “LOCK,” you can switch tones within the currently selected category.



## Selecting Tones from a List

You can access the tone list and select tones from that list.

1. Move the cursor in the screen to the tone number: tone name.
2. Press the [ENTER] button.

The tone list screen appears.

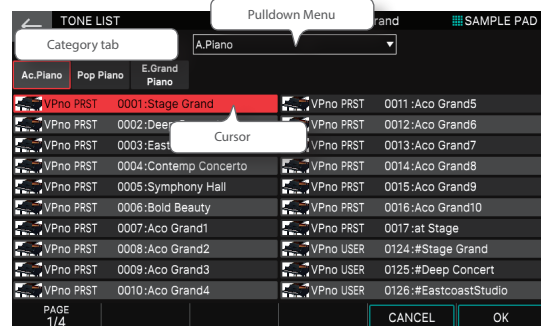

Operation	Explanation
Touch a category tab	Selects another category in the same category group
Pull-down Menu	Selects a category from a list.
PAGE [E1] knob	Switches the page of the selected category.
[E6] OK	Confirms the operation and returns to the ZONE VIEW screen.
[ENTER] button	Confirms the operation and returns to the ZONE VIEW screen.
[E5] CANCEL	Cancels the operation and returns to the ZONE VIEW screen.

3. Select a tone.
4. Select [E6] OK.

If you decide to cancel, choose [E5] CANCEL. You return to the ZONE VIEW screen.

# Performing

## Playing One Tone in One Zone (Single)

Most of the scenes provided by the factory settings produce sound using a combination of multiple zones. These are created so that playing a key might sound multiple tones, or that different tones might sound in different areas of the keyboard. If you want to focus on a single tone and just use a single zone to play that one tone, it is convenient to use the “Single Tone” function.

### 1. Press the [SCENE SELECT] button.

The SCENE SELECT screen appears.

### 2. Select the scene whose settings you want to change.

### 3. Press the [SINGLE TONE] button.

Now you can use the single tone play function.

#### In single play

- Only the sound of ZONE 1 is heard when you play the keyboard.
- An acoustic piano tone is selected.
- The ZONE VIEW screen (1 ZONE VIEW) appears.



### 4. Select a tone and play it.

### 5. If you want to save the modified settings as a scene, press the [SINGLE TONE] button once again.

The CONFIRM screen appears.

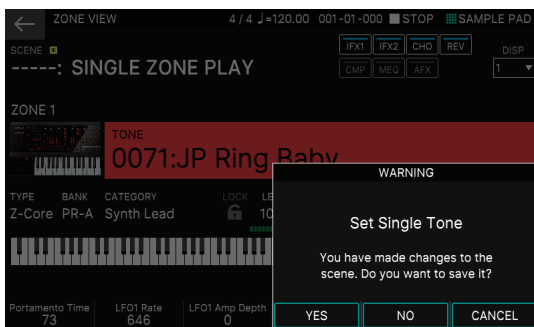

### 6. Select [E4] YES.

The SCENE WRITE screen appears.

If you decide to cancel, choose [E6] CANCEL.

#### MEMO

If you select [E5] NO, you return to the state of step 3.

### 7. Save the scene as described in “Saving a Scene” (p. 44).

#### MEMO

As an alternative to this procedure, you can select the A:016 “Single Tone Play” scene and use single tone play.

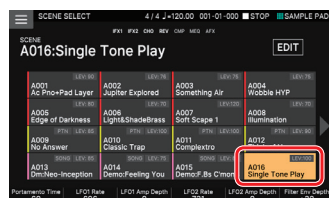

## Layering Zones (Layer)

You can layer multiple tones so that they are heard simultaneously when you play the keyboard. This type of setup is called a “layer.” The FANTOM lets you layer the desired zones and play them as layers.

### 1. Press the ZONE INT/EXT button of the zones that you want to layer, making them light red.

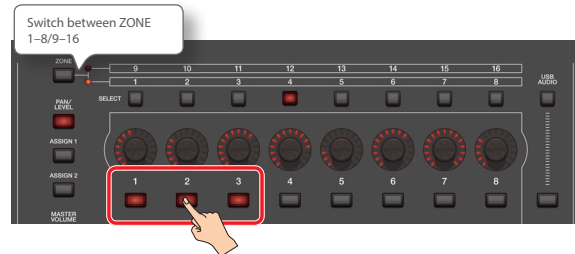

For this example, press the ZONE INT/EXT buttons for ZONE 1, 2, and 3 to make them light red.

#### MEMO

To make a ZONE 9–16 light red, press the [ZONE 1-8/9-16] button to switch the target range of zones.

### 2. Of the zones that are lit, press the ZONE SELECT button of one zone to specify it as the current zone.

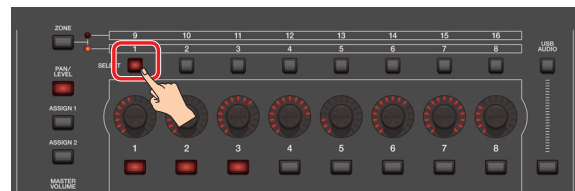

For this example, we specify ZONE 1 as the current zone of the three ZONE 1–3 that are lit red. You are free to specify ZONE 2 or ZONE 3 if you like.

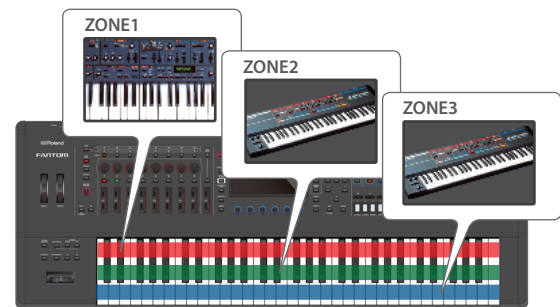

When you play the keyboard in this state, the zones that are lit red (ZONE 1–3) sound together.

#### NOTE

Zones whose ZONE INT/EXT button is lit green are controlling an external MIDI sound module.

To switch to the internal sound engine, once again hold down the [SHIFT] button and press the corresponding ZONE INT/EXT button to make the button light red (INT setting).



## Selecting a Tone (Layer)

### 1. Press the [ZONE VIEW] button.

The ZONE VIEW screen appears.

Select the VIEW number as appropriate for the zones that are layered.

### 2. Switch the current zone and select a tone for each zone.

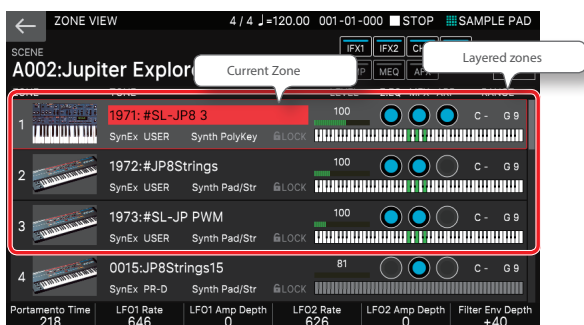

### 3. Save the scene as described in “Saving a Scene” (p. 44).

## Dividing the Keyboard into Two Regions (Split)

You can divide the keyboard into left-hand and right-hand ranges, and play a different tone in each range.

This type of setup is called a “split,” and the point at which the keyboard is divided is called the “split point.”

### 1. Select a scene for single play.

### 2. Press the [SPLIT] button to make it light.

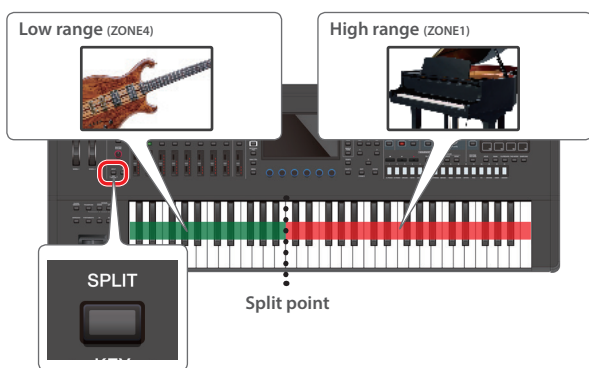

Split is enabled; you can play the ZONE 1 tone in the high range, and the ZONE 4 tone in the low range.

### 3. To cancel split, press the [SPLIT] button to make it dark.

When you disable split, the high and low range settings (KEY RANGE) are reset, and ZONE 1 and 4 are layered.

#### NOTE

On the FANTOM, the [SPLIT] button is lit whenever the high and low range settings (KEY RANGE) of any zone are other than the default values (low C-: high G9). Even if zones are layered, the button is lit whenever the KEY RANGE settings are other than the default. Making the [SPLIT] button go dark means that the KEY RANGE settings of all zones are reset to the default values.

## Changing the Keyboard’s Split Point

### 1. While holding down the [SPLIT] button, press the key that is to become the new split point.

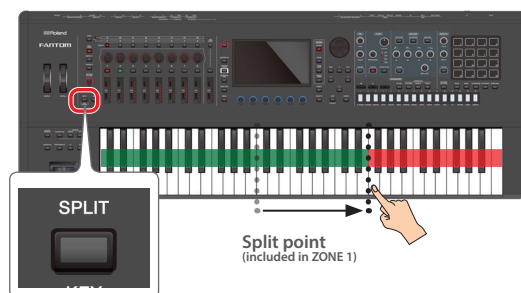

When you press a key, the split point is shown.

When you release the [SPLIT] button, the previous display will reappear.

The split-point key is included in the ZONE 1 section.

## Selecting a Tone (Split)

### 1. Press the [ZONE VIEW] button.

The ZONE VIEW screen appears.

Select the VIEW number that’s appropriate for the number of zones that are split.

### 2. Switch the current zone and select a tone for each zone.

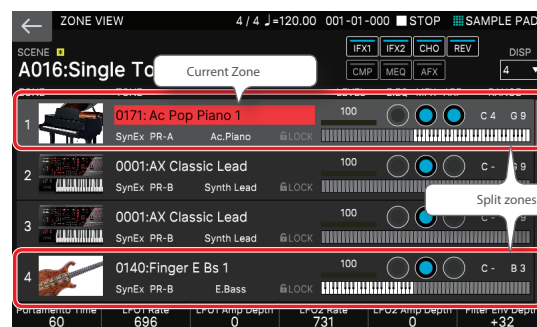

Hold down ZONE SELECT [1] if you want to change the tone of the high range, or hold down ZONE SELECT [4] if you want to change the tone of the low range, and then select a tone.

### 3. Save the scene as described in “Saving a Scene” (p. 44).

## Playing Multiple Zones

You can use layers and splits together to create and play more complex combinations.

### Specifying the Range of Each Zone (KEY RANGE)

By using a combination of layers and split, you can create and play more complex combinations. By using the KEY RANGE function, you can freely specify the key range of each zone. You can create splits that use numerous zones, or layer only a specific key range.

Split using multiple zones

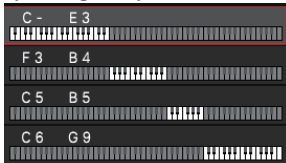

Specific key ranges are layered

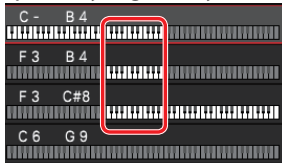

#### About unlit zones

If you play the keyboard when the ZONE INT/EXT button of the current zone is unlit, only the current zone is heard regardless of the lit status of other zones.

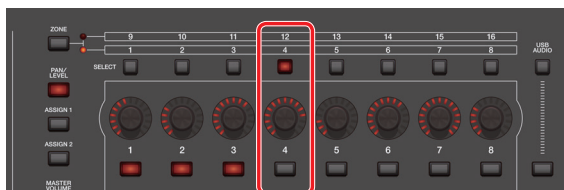

In this example, only ZONE 4 (the current zone) is heard when you play the keyboard.

Normally, zones whose ZONE INT/EXT button is unlit do not respond to your playing, and are used mainly to play MIDI messages from a sequencer. If you want to hear the sound of such zones, you can successively switch the current zone to each unlit zone and play the keyboard to hear the sound of that zone.

Since the current zone is saved in the scene, take care to return the current zone to its original setting before you save.

### 1. Press the [ZONE VIEW] button.

The ZONE VIEW screen appears.

Select the VIEW number that's appropriate for the number of zones you're using.

### 2. Layer the zones that you want to use (p. 24).

### 3. In the ZONE VIEW screen, move the cursor to KEY RANGE, and set the key range (KEYBOARD RANGE LOWER/UPPER) of each zone.

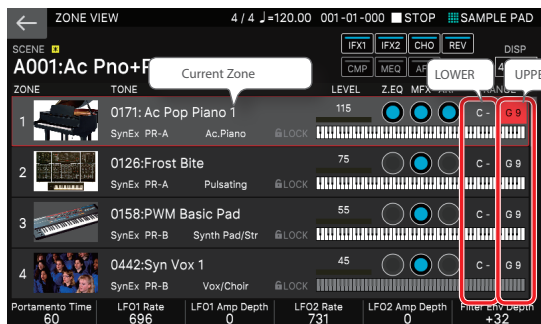

Parameter	Explanation
KEYBOARD RANGE LOWER	Sets the lower limit of the key range
KEYBOARD RANGE UPPER	Sets the upper limit of the key range.

When you edit the KEYBOARD RANGE LOWER/UPPER values, the [SPLIT] button is automatically lit.

#### MEMO

If you hold down the [SHIFT] button and press the [SPLIT] button, the KEY RANGE screen of ZONE EDIT appears. The KEY RANGE settings can also be edited in this screen. For details, refer to "Parameter Guide" (PDF).

# Changing the Keyboard Settings

## Raising/Lowering the Key Range in Semitone Steps (Transpose)

1. Hold down the [TRANSPOSE] button and press the OCTAVE [DOWN] button or [UP] button.

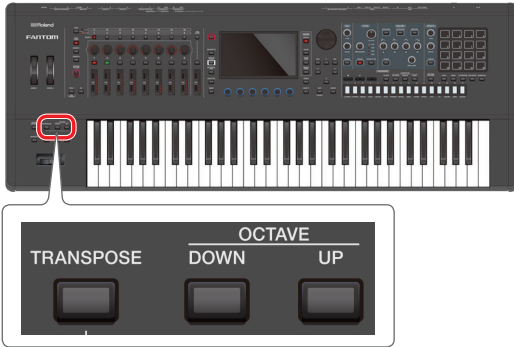

When you press the button, the screen shows the value of the setting.

Parameter	Value	Explanation
Transpose	-5→+6	Specifies the key range in semitone steps.

### MEMO

- To cancel transpose, press the [TRANSPOSE] button once again to make it go dark. Once you have set transpose, you can simply press the [TRANSPOSE] button to instantly transpose to the previously-set value.
- If you hold down the [TRANSPOSE] button and press the OCTAVE [DOWN] and [UP] buttons simultaneously, the value is returned to "0."

## Raising/Lowering the Key Range in Octaves (Octave)

1. Press the OCTAVE [DOWN] button or [UP] button.

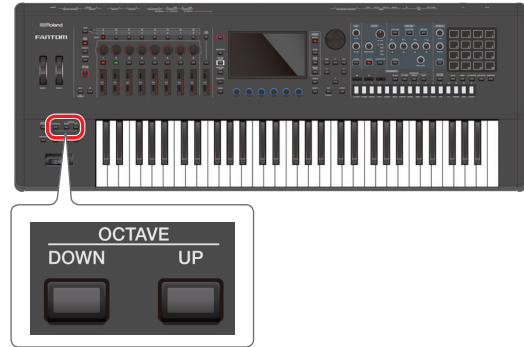

When you press the button, the screen shows the value of the setting.

Parameter	Value	Explanation
Octave	-3→+3	Specifies the key range in octaves.

### MEMO

- If you press the OCTAVE [DOWN] and [UP] buttons simultaneously, the value is returned to "0."

## Memo

# 03: Performance Functions

## Contents

### Playing Arpeggios..... 30

- ◇ Using the Arpeggiator..... 30
- ◇ Setting the Arpeggiator Tempo..... 30
- ◇ Holding the Arpeggio (Hold)..... 31
  - Using a Pedal Switch..... 31
- ◇ Arpeggiator Settings..... 31

### Playing Chords (Chord Memory)..... 32

- ◇ Performing with the Chord Memory Function..... 32
- ◇ Chord Memory Settings..... 32

### Performing with Rhythm Patterns..... 33

- ◇ Selecting/Playing Rhythm Patterns..... 33
- ◇ Editing a Rhythm Pattern Group..... 34
  - Saving a Rhythm Pattern Group..... 34
- ◇ Changing the Tempo of the Rhythm Pattern .. 35
- ◇ Saving the Rhythm Pattern Settings..... 35

### Playing the General-Purpose Controllers.. 36

- ◇ Using the Sliders and Control Knobs..... 36
- ◇ Using Other General-Purpose Controllers..... 37

### Playing the Edit Knobs..... 38

- ◇ Using the Edit Knobs..... 38

### Simultaneously Modifying the Volume of Multiple Zones (Motional Pad)..... 39

- ◇ Using the Motional Pad..... 39
- ◇ Editing the Motional Pad Settings..... 39
  - Changing the Assigned Zones..... 39
  - Switching the Tone Assigned to a Zone..... 39
  - Other Settings for Motional Pad..... 40

# Playing Arpeggios

## Using the Arpeggiator

The FANTOM has an arpeggiator that can automatically generate arpeggios.

### MEMO

Arpeggio settings are saved in the scene.

### 1. Press the [ZONE VIEW] button.

The ZONE VIEW screen appears.

Select the VIEW number as appropriate for the number of zones you are using.

### 2. In the ZONE VIEW screen, turn ARP "ON" for the zone that you want to arpeggiate.

### NOTE

When the [ARPEGGIO] button is "ON," arpeggios can be played in zones whose ARP is "ON."

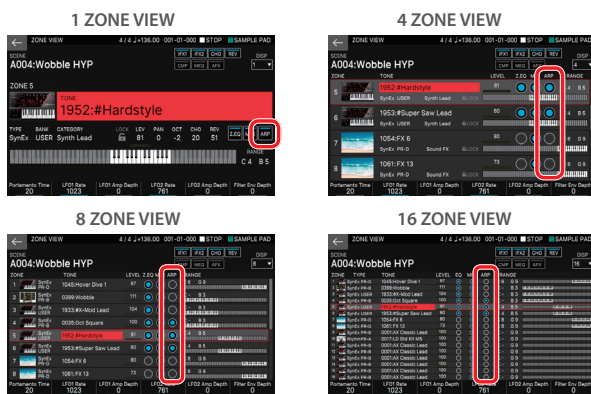

### MEMO

You can turn ARP "ON" for multiple zones and make them play arpeggios simultaneously.

### 3. Press the [ARPEGGIO] button to make it light.



The ARPEGGIO screen appears.

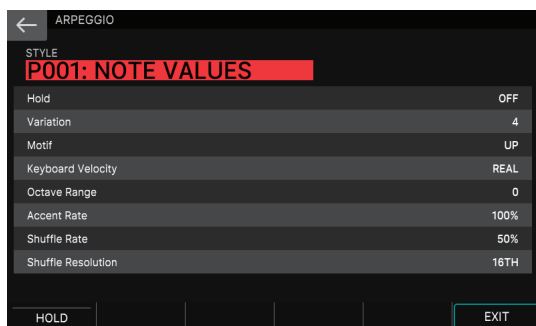

Menu	Explanation
[E1] HOLD	Holds the arpeggio.
[E6] EXIT	Returns to the previous screen.

### MEMO

By setting the system parameter "Arpeggio Switch Mode" (p. 113), you can turn the arpeggiator on without accessing the ARPEGGIO screen.

### 4. Play a chord on the keyboard.

An arpeggio is sounded by the zone that is turned on, according to the notes of the chord that you play.

### 5. Move the cursor to "STYLE" and change the style.

The arpeggio performance changes according to the style that you select.

### 6. To turn the arpeggiator off, press the [ARPEGGIO] button once again to make it go dark.

### MEMO

By using this together with the chord memory function, you can easily play a variety of arpeggio sounds with a single finger (p. 32).

## Setting the Arpeggiator Tempo

You can set the tempo of the arpeggios.

### MEMO

- The tempo that you specify here is used in common with the rhythm pattern tempo (p. 35) and the sequencer tempo (p. 82).
- The tempo value is saved in the scene.

### 1. Press the [TEMPO] button.



The TEMPO screen appears.

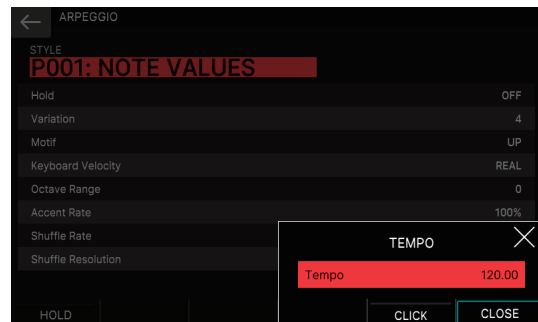

Menu	Explanation
[E5] CLICK	If this is on, a click is heard at the specified tempo.
[E6] CLOSE	Closes the screen.

### 2. Use the [VALUE] dial or the [INC][DEC] buttons to set the Tempo.

By holding down the [SHIFT] button while you perform this operation, you can adjust the value of the two digits below the decimal point.

### MEMO

You can set the tempo by pressing the [TEMPO] button at the desired interval ("tap tempo"). Press the button at least three times, at quarter-note intervals of the desired tempo.

## Holding the Arpeggio (Hold)

Here's how to make the arpeggio continue sounding even after you release the keyboard.

### 1. Press the [ARPEGGIO] button.

The ARPEGGIO screen appears.

**MEMO**

By holding down the [SHIFT] button and pressing the [ARPEGGIO] button, you can access the ARPEGGIO screen without affecting the arpeggio on/off status.

### 2. Select [E1] HOLD.

The hold function turns on.

### 3. Play a chord on the keyboard.

An arpeggio is sounded by the zone that is turned on, according to the notes of the chord that you play.

If you play a different chord or key while the arpeggio is being held, the arpeggio also changes.

### 4. To turn it off, select [E1] HOLD once again.

The hold function turns off.

## Using a Pedal Switch

If you hold down a pedal switch (p. 10) while playing a chord, the arpeggio continues playing even if you release the keyboard.



### 1. Connect your pedal switch (e.g., DP series; sold separately) to the HOLD/R jack.

### 2. Press the [ARPEGGIO] button to make it light.

### 3. Play a chord while holding down the pedal switch.

If you play a different chord or key while the arpeggio is being held, the arpeggio also changes.

## Arpeggiator Settings

You can make detailed settings for the arpeggio's performance style, timing, and accent.

### 1. Press the [ARPEGGIO] button.

The ARPEGGIO screen appears.

**MEMO**

By holding down the [SHIFT] button and pressing the [ARPEGGIO] button, you can access the ARPEGGIO screen without affecting the arpeggio on/off status.

### 2. Select the desired parameter, and edit its value.

Parameter	Value	Explanation
STYLE	P001–P128	Specifies the basic way in which the arpeggio will be played.
Hold	OFF, ON	Turn the hold function on/off.
Variation	1–	The arpeggiator provides several variations (performance patterns) for each arpeggio style. This parameter selects the variation number. The number of variations will differ according to the arpeggio style.

Parameter	Value	Explanation
Motif		Sets the order in which notes of the chord will sound.
	UP	Notes you press will be sounded, from low to high.
	DOWN	Notes you press will be sounded, from high to low.
	UP&DOWN	Notes you press will be sounded, from low to high, and then back down from high to low.
	RANDOM	Notes you press will be sounded, in random order.
	NOTE ORDER	Notes you press will be sounded in the order in which you pressed them. By pressing the notes in the appropriate order you can produce melody lines. Up to 128 notes will be remembered.
	GLISSANDO	Each chromatic step between the highest and lowest notes you press will sound in succession, repeating upward and downward. Press only the lowest and the highest notes.
	CHORD	All notes you press will sound simultaneously.
	AUTO1	The timing at which keys will sound will be assigned automatically, giving priority to the lowest key that was pressed.
	AUTO2	The timing at which keys will sound will be assigned automatically, giving priority to the highest key that was pressed.
PHRASE	Pressing a single key will sound the phrase based on the pitch of that key. If multiple keys are pressed, the last-pressed key will be valid.	
Keyboard Velocity	REAL, 1–127	Specifies the loudness of the notes that you play. If you want the velocity value of each note to depend on how strongly you play the keyboard, set this parameter to "REAL." If you want each note to have a fixed velocity regardless of how strongly you play the keyboard, set this parameter to the desired value (1–127).
Octave Range	-3+3	Sets the key range in octaves over which arpeggio will take place. If you want the arpeggio to sound using only the notes that you actually play, set this parameter to "0." To have the arpeggio sound using the notes you play and notes 1 octave higher, set this parameter to "+1." A setting of "-1" will make the arpeggio sound using the notes you play and notes 1 octave lower.
Accent Rate	0–100%	Modifies the strength of accents and the length of the notes to adjust the "groove" feel of the arpeggio. A setting of "100%" will produce the most pronounced groove feel.
Shuffle Rate	0–100%	This setting lets you modify the note timing to create shuffle rhythms. With a setting of "50%" the notes will be spaced evenly. As the value is increased, the note timing will have more of a "dotted" (shuffle) feel. <div style="text-align: center;"> <p>Shuffle Rate 50%</p> <p>50 50 50 50</p> <p>Shuffle Rate 90%</p> <p>90 10 90 10</p> </div>
Shuffle Resolution	16TH, 8TH	Specifies the timing (as a note value) at which the notes will be heard. The note value can be specified as either a sixteenth note or an eighth note.

# Playing Chords (Chord Memory)

## Performing with the Chord Memory Function

Chord memory is a function that lets you register chord forms and then produce chords of that form simply by playing a single key.

### MEMO

Chord memory settings are saved in the scene.

### 1. Press the [ZONE VIEW] button.

The ZONE VIEW screen appears.

Select the VIEW number as appropriate for the number of zones you are using.

### 2. In the ZONE VIEW screen, turn ARP "ON" for the zone that you want to use.

#### NOTE

When the [CHORD MEMORY] button is "ON," you can play arpeggios in the zones whose ARP is "ON."

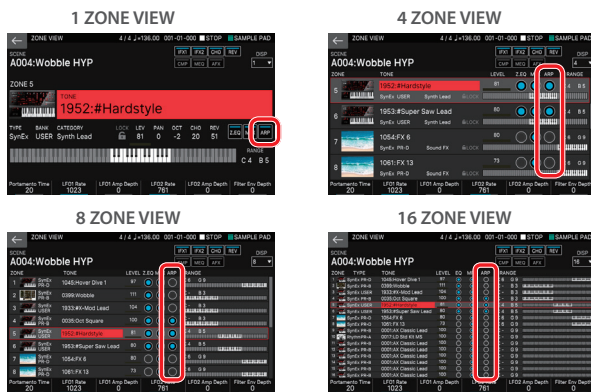

#### MEMO

You can also turn ARP "ON" for multiple zones and play chords in them simultaneously.

### 3. Press the [CHORD MEMORY] button to make it light.



The CHORD MEMORY screen appears.

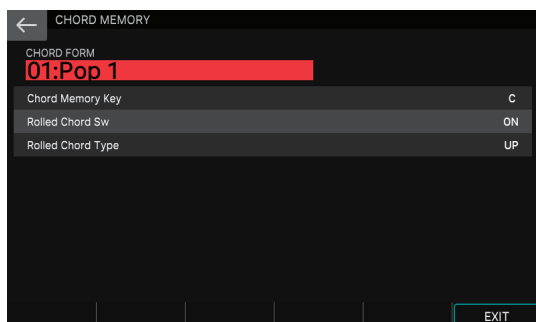

Menu	Explanation
[E6] EXIT	You return to the previous screen.

### MEMO

By setting the system parameter "Chord Memory Switch Mode" (p. 113), you can turn chord memory "on" without accessing the Chord Memory screen.

### 4. Play the keyboard.

A chord is sounded according to the currently selected chord form.

### 5. Move the cursor to "CHORD FORM" and change the chord form.

This changes the way in which the chord is sounded.

For more about chord forms, refer to "Chord Memory List" (p. 120).

### 6. To turn the function off, press the [CHORD MEMORY] button once again to make it go dark.

## Chord Memory Settings

Here's how to edit the chord memory settings.

### 1. Press the [CHORD MEMORY] button.

The CHORD MEMORY screen appears.

#### MEMO

By holding down the [SHIFT] button and pressing the [CHORD MEMORY] button, you can access the CHORD MEMORY screen without affecting the chord memory on/off status.

### 2. Select the desired parameter, and edit its value.

Parameter	Value	Explanation
CHORD FORM	01-17	Selects the type of chord set that's assigned to the C-B keys. For more about chord forms, refer to "Chord Memory List" (p. 120).
Chord Memory Key	G-F#	Changes the key of the chord.
Rolled Chord Sw	ON	The notes of the chord sound sequentially rather than simultaneously. Since the speed of the performance changes depending on the force with which you play the keyboard, you can produce a realistic simulation of guitar playing just by varying your playing dynamics.
	OFF	The notes sound as a chord.
Rolled Chord Type	UP	Notes sound sequentially from low to high.
	DOWN	Notes sound sequentially from high to low.
	ALTERNATE	The order in which the notes sound alternates each time you play the keyboard.



# Performing with Rhythm Patterns

## What is a rhythm pattern?

The FANTOM can automatically play a variety of rhythms while you perform.

The performance data for these rhythms are called “rhythm patterns.”

In a band, the drums typically repeat fixed patterns that are one or two measures long. A wide variety of performance data used as the basis of these repetitions is built-in and organized into categories for uses such as intro, bass, fill, and ending. The type of each pattern is indicated by its rhythm pattern name.

Pattern	Explanation
Intro	These are performance patterns used during the introduction.
Verse 1, 2	These are the main performance patterns. “1” is the basic pattern, and “2” is a variation of it.
Fill-In 1, 2	These are ornamental performance patterns inserted between phrases. Choose either “1” or “2” depending on the pattern that follows the fill.
Ending	These are performance patterns used during the ending of the song.

### MEMO

Rhythm pattern settings are saved in the scene.

## What is a rhythm group?

A “rhythm pattern group” contains a set of six rhythm patterns. You can specify a rhythm pattern for Intro, Pattern A–Pattern D, and Ending, and save them as a rhythm pattern group.

The FANTOM provides the following rhythm groups.

Rhythm Pattern Group	Explanation
PRST (PRESET)	These are rhythm pattern groups that cannot be rewritten. Rhythm pattern settings that you edit can be saved as a user group.
USER	These are rhythm pattern groups that can be saved in the FANTOM.

## What is a drum kit?

The drum sounds played by the rhythm patterns are called a “drum kit.”

The ZONE 10 tone (Drum Kit tone) of the current scene is used as the drum kit.

## Selecting/Playing Rhythm Patterns

### 1. Press the [RHYTHM PATTERN] button.



The RHYTHM PATTERN screen appears.

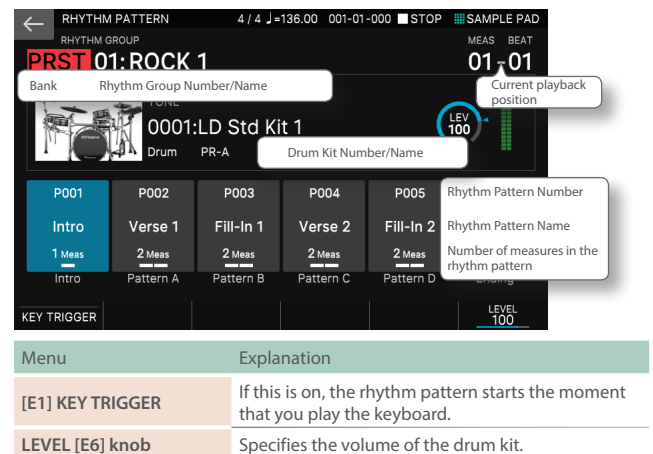

### 2. Move the cursor to the “rhythm group number,” and select a rhythm pattern group.

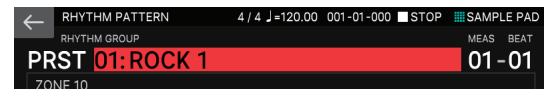

### 3. Move the cursor to the drum kit number, and select a drum kit.

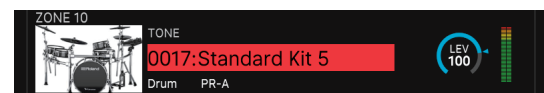

### 4. Touch <Intro>–<Ending> and select the rhythm pattern that will be played for each.

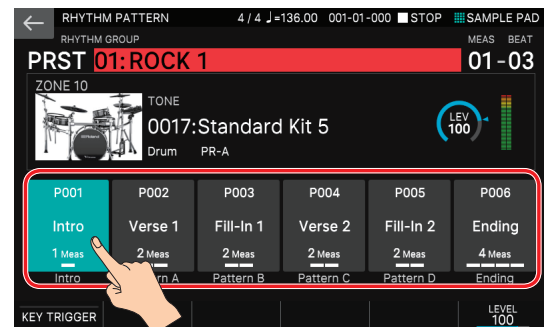

The [RHYTHM PATTERN] button is lit, and the rhythm pattern you touch plays.

**5. To stop, touch the icon of the rhythm pattern that's playing, or press the [STOP] button.**

**MEMO**

- The length of the pattern is shown below each rhythm pattern name. If you select a different rhythm pattern while a pattern is playing, the pattern switches at a measure division.
- If you play a rhythm pattern that's assigned as Intro, playback automatically switches to Pattern A when the Intro has finished playing.
- If you play a rhythm pattern that's assigned as Ending, the rhythm pattern automatically stops when the Ending has finished playing.

## Editing a Rhythm Pattern Group

You can edit a rhythm pattern group and freely assign rhythm patterns to it.

**1. Press the [RHYTHM PATTERN] button.**

The RHYTHM PATTERN screen appears.

**2. Use the cursor [▲] [▼] [◀] [▶] buttons to move the cursor to one of the Intro–Ending fields.**

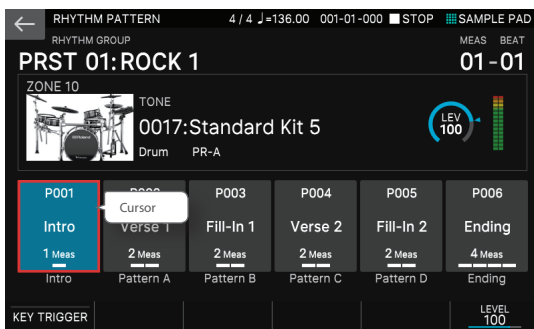

**3. Use the [VALUE] dial or the [INC][DEC] buttons to select the rhythm pattern that you want to assign.**

**4. Repeat steps 2–3 to specify other rhythm patterns.**

## Saving a Rhythm Pattern Group

The edited rhythm group is temporary, and will be lost when you turn off the power or select another rhythm group.

If you want to keep the edited rhythm group, write it to a user group in the FANTOM.

**NOTE**

When you execute the write operation, the existing data in the write-destination is overwritten.

**1. Press the [WRITE] button.**

The WRITE MENU screen appears.

**2. Touch <RHYTHM PATTERN GROUP>.**

The RHYTHM PATTERN GROUP WRITE screen appears.

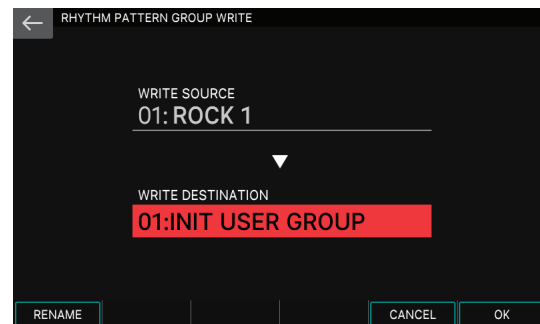

**3. If you want to edit the name, select [E1] RENAME.**

After editing the name, select [E6] OK to close the window.

**4. Use the [VALUE] dial or the [DEC][INC] buttons to select the write-destination.**

**5. Select [E6] OK.**

A confirmation message appears.

If you decide to cancel, choose [E5] CANCEL.

**6. Select [E5] OK.**

The rhythm pattern group is saved.

## Changing the Tempo of the Rhythm Pattern

Here's how to change the tempo of the rhythm pattern.

### MEMO

- The tempo that you specify here is common with the arpeggio tempo (p. 30) and the sequencer tempo (p. 82).
- The tempo value is stored in the scene.

### 1. Press the [TEMPO] button.

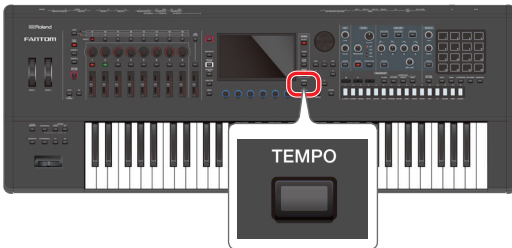

The TEMPO screen appears.

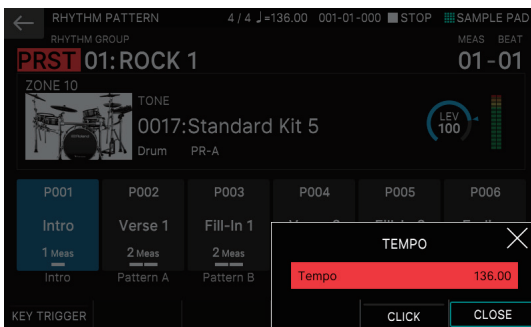

Menu	Explanation
[E5] CLICK	If this is on, a click is heard at the specified tempo.
[E6] CLOSE	Closes the screen.

### 2. Use the [VALUE] dial or the [INC][DEC] buttons to edit the tempo.

By holding down the [SHIFT] button while you perform this operation, you can edit the two digits below the decimal point.

### MEMO

You can set the tempo by pressing the [TEMPO] button at the desired interval ("tap tempo"). Press the button at least three times, at quarter-note intervals of the desired tempo.

## Saving the Rhythm Pattern Settings

Settings related to the rhythm pattern, such as the currently selected rhythm pattern group, drum kit settings, KEY TRIGGER settings, and tempo etc. are stored together in the current scene. If you want to keep these settings, save the scene (p. 44).

# Playing the General-Purpose Controllers

## Using the Sliders and Control Knobs

You can use the sliders and control knobs to control the pan and volume of each zone, or assign various functions and parameters to them as general-purpose controllers.

1. Use the [ZONE 1-8/9-16] button to switch the zones that you want to control (ZONE 1–ZONE 8 or ZONE 9–ZONE 16).

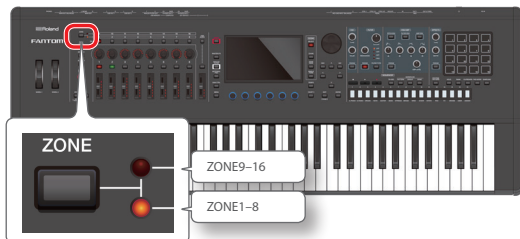

2. Press a function select button to select the parameter that you want to control.

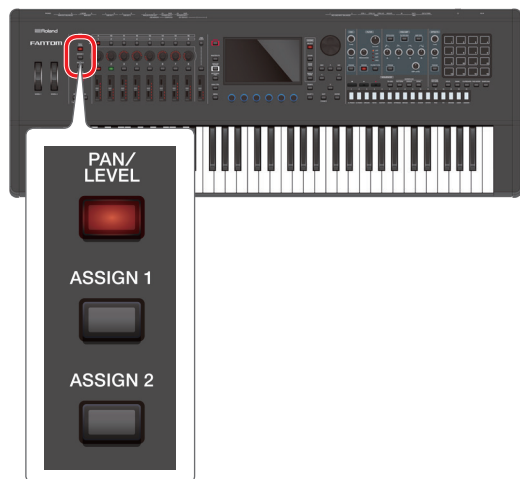

Button	Explanation
[PAN/LEVEL] button	When this is lit, the control knobs adjust the pan of each zone, and the sliders adjust the volume of each zone.
[ASSIGN1] button (SCENE)	When one of these is lit, the control knobs and sliders adjust the parameters that are assigned to them by the scene or the system.
[ASSIGN2] button (SYSTEM)	

### MEMO

The function assignments of ASSIGN 1 are made individually for each scene.  
The function assignments of ASSIGN 2 are common to the entire system.

## To control PAN/LEVEL

3. Press the [PAN/LEVEL] button to make it light.
4. Move a control knob or slider.

The pan or volume of the corresponding zone changes.



When you use a control knob or slider to edit a setting, the edited parameter and its value appears in a popup window. The popup window automatically closes after a time. For some parameters, a popup window does not appear.

### MEMO

When controlling [PAN/LEVEL], the control knob or slider numbers correspond to the zone numbers.

## To control ASSIGN 1 or ASSIGN 2

5. Press the [ASSIGN 1] or [ASSIGN 2] button to make it light.

6. Select the current zone.

As necessary, specify the layer as well.

7. Move a control knob or slider.

The sound changes according to the assigned function.

### MEMO

When using [ASSIGN 1] [ASSIGN 2], operating a control knob or slider affects the zone(s) that are heard when you play the keyboard.

- If you're using layered settings, multiple zones are affected.
- If you're not using layered settings, the current zone is affected.

By holding down the [SHIFT] button and pressing the [ASSIGN 1] or [ASSIGN 2] button, you can access a setting screen for assigning parameters or functions. For details, refer to "Parameter Guide" (PDF) or "System Parameters" (p. 112).

## Using Other General-Purpose Controllers

In addition to the sliders and control knobs, the pitch bend/modulation lever, pedal switches and expression pedals connected to the PEDAL jacks, WHEEL 1–2, and the [S1]–[S3] buttons can be used as general-purpose controllers. You can assign various functions or parameters to these controllers.

\* The functions operated by the pitch bend/modulation lever and the HOLD/R jack are fixed.

1. Use the [ZONE 1-8/9-16] button to select the zones that you want to work with (ZONE 1–ZONE 8 or ZONE 9–ZONE 16).
2. Select the current zone.  
If necessary, make layer settings as well.
3. Operate a general-purpose controller.

The sound changes according to the assigned function.



Button	Explanation
Pitch bend lever	Varies the pitch. Other functions cannot be assigned.
Modulation lever	Transmits control change CC#01 to apply vibrato. Other functions cannot be assigned.
PEDAL jack (CTRL 1, CTRL 2/L, CTRL 3/C)	Connect pedal switches or expression pedals to these jacks to use them. Various functions can be assigned. Operate a pedal to use the assigned function.
PEDAL jack (HOLD/R)	Connect a pedal switch to this jack to use it. This can be used as a damper pedal. Other functions cannot be assigned.
WHEEL1 WHEEL2	Various parameters and functions can be assigned. To use the assigned function, move the wheel while you play.
[S1]–[S3] button	Various parameters and functions can be assigned. To use the assigned function, press the button.

**MEMO**

- Operating these general-purpose controllers affects the zone(s) that are heard when you play the keyboard. (If you're using layered settings, multiple zones are affected. If you're not using layered settings, the current zone is affected.)
- The functions assigned to these general-purpose controllers can be specified for the entire system or individually for each scene. A system setting determines whether the system-wide settings or the individual scene settings are used.

Parameter	Explanation
Pedal Assign Source	Specifies whether the functions controlled by a pedal connected to the PEDAL CTRL 1, 2/L, and 3/C jacks are specified by the system settings (SYS) or by the settings of the scene (SCENE).
Wheel Assign Source	Specifies whether the functions controlled by the wheels are specified by the system settings (SYS) or by the settings of the scene (SCENE).
S1-S3 Assign Source	Specifies whether the functions controlled by the [S1], [S2], and [S3] buttons are specified by the system settings (SYS) or by the settings of the scene (SCENE).

\* Because the functions of the pitch bend/modulation lever and the PEDAL HOLD/R jack are fixed, there is no setting screen for their assignments.

For details on the setting screens and their operation, refer to "System Parameters" (p. 112).

**MEMO**

By holding down the [SHIFT] button and operating the WHEEL 1–2, [S1]–[S3] button, or a pedal connected to the PEDAL CTRL 1, 2/L, 3/C jack you can access the setting screen for assigning a parameter or function. For details, refer to "Parameter Guide" (PDF) or "System Parameters" (p. 112).

# Playing the Edit Knobs

## Using the Edit Knobs

You can use the knobs and buttons of the OSC section, FILTER section, ENV/AMP section, and EFFECT section to edit the sound in real time.



### MEMO

Edit knobs that are enabled are lit blue around the circumference of the knob.

1. Select the scene that you want to play.
2. Operate the edit knobs and buttons to edit the sound.

The edited parameter and its value appear in a popup window.

### OSC (Oscillator) section

This selects the waveform that determines the character of the sound.



Controller	Explanation
[TYPE] knob	Specifies the OSC type. The OSC types change according to the tone type.
[VALUE] knob	Edits a parameter corresponding to the OSC type. Example: OSC TYPE=PCM → "Wave No."
[PARAM] button	Accesses the OSC setting screen of the TONE EDIT ZOOM screen.

### FILTER section

This specifies the brightness and thickness of the sound.



Controller	Explanation
[CUTOFF] knob	Specifies the cutoff frequency of filter.
[RESONANCE] knob	Specifies the resonance of filter. This adds a distinctive character to the sound.
[FILTER TYPE] button	Specifies the type of filter. The filter response changes according to the type you select.
[PARAM] button	Accesses the FILTER setting screen of the TONE EDIT ZOOM screen.

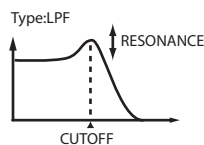

### ENV/AMP section

This specifies time-varying changes in pitch, tonal character, and volume.



Controller	Explanation
[PITCH ENV] button	Use the [A] [D] [S] [R] knobs to edit the pitch envelope (time-varying change in pitch).
[FILTER ENV] button	Use the [A] [D] [S] [R] knobs to edit the filter envelope (time-varying change in cutoff frequency).
[AMP ENV] button	Use the [A] [D] [S] [R] knobs to edit the amp envelope (time-varying change in volume).
[A] knob	Specifies the attack time of the envelope. This is the time from when you press the key until the maximum value is reached.
[D] knob	Specifies the decay time of the envelope. This is the time over which the maximum value decreases to the sustain level.
[S] knob	Specifies the sustain level of the envelope. This is the value that is maintained while you hold down the key.
[R] knob	Specifies the release time of the envelope. This is the time from when you release the key until the value reaches zero.
[AMP LEVEL] knob	Adjusts the volume.
[PARAM] button	Accesses the TONE EDIT screen. The screen that appears depends on the PITCH, FILTER, or AMP parameters that are selected.

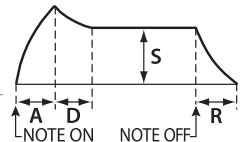

### EFFECTS section

This applies various effects to the sound.



Controller	Explanation
[TYPE] knob	Specifies the MFX TYPE of the selected zone.
[DEPTH] knob	Specifies the MFX DEPTH of the selected zone.
[PARAM] button	Accesses the MFX screen of EFFECTS EDIT.

### NOTE

Unlike when using the general-purpose controllers, the changes that you make using the edit knobs always apply only to the tone of the current zone. If you're using the keyboard to play multiple layered tones, select the zone that you want to edit as the current zone before you operate the knobs. Depending on the tone type, the tone might consist of multiple partials, but the changes you make using the knobs apply to the partial that is selected. For details on how to select a partial and use the various TONE EDIT screens, refer to "Editing a Tone" (p. 45).

### MEMO

- If you want to keep an edited tone, save the tone (p. 48).
- For details on each parameter, refer to "Parameter Guide" (PDF).

# Simultaneously Modifying the Volume of Multiple Zones (Motional Pad)

## Using the Motional Pad

The motional pad function lets you simultaneously modify the volume of four zones by dragging in the screen. By using the motional pad function, you can produce diverse tonal changes with a single finger.

### MEMO

- Motional pad settings are saved in the scene.
- By holding down the [SHIFT] button and pressing the [MOTIONAL PAD] button, you can access the MOTIONAL PAD screen without affecting the motional pad on/off status.

### 1. Press the [MOTIONAL PAD] button.

The [MOTIONAL PAD] button is lit, and the MOTIONAL PAD screen appears.

The numbers of the zones being used with the motional pad function are shown in the zone number areas at the four corners of the screen. If an applicable zone is off, press the ZONE INT/EXT button [1]–[8] to turn the zone on.

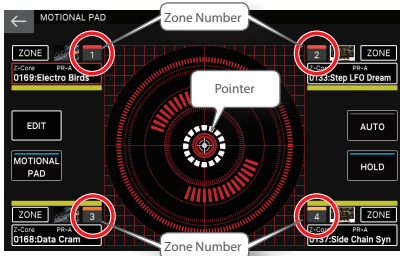

Menu	Explanation
<EDIT>	Moves to the edit screen.
<MOTIONAL PAD>	Switches the motional pad function on/off in the same way as the [MOTIONAL PAD] button.
<AUTO>	If this is on, the pointer moves automatically.
<HOLD>	If this is on, the most recent pointer position is held when you take your finger off the screen. If this is off, the pointer position is reset when you take your finger off the screen.
[EXIT] button	Returns to the previous screen.

### 2. While holding down a key, drag the circle (pointer) in the center of the screen to move it.

The volume balance of the four zones changes according to the position of the pointer, and the sound changes in real time.

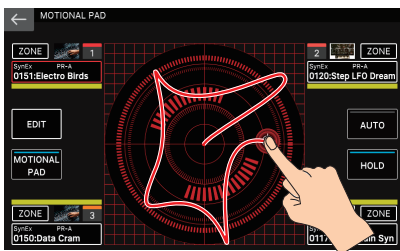

## Editing the Motional Pad Settings

In the MOTIONAL PAD screen, you can change the assigned zones and switch tones.

### Changing the Assigned Zones

#### 1. Press the [MOTIONAL PAD] button.

The MOTIONAL PAD screen appears.

#### 2. Touch one of the <ZONE> areas located in the four corners of the screen.

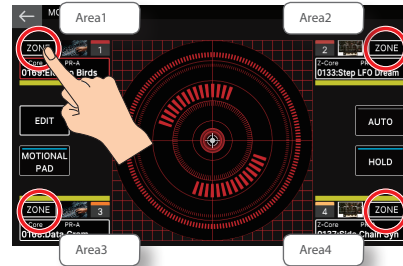

The MOTIONAL PAD ZONE SELECT screen appears.

#### 3. Touch the number of the zone that you want to assign.

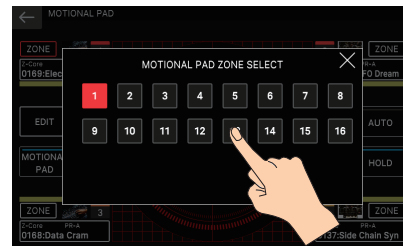

The zone assignment is changed, and you return to the MOTIONAL PAD screen.

### Switching the Tone Assigned to a Zone

#### 1. Press the [MOTIONAL PAD] button.

The MOTIONAL PAD screen appears.

#### 2. Touch one of the tone names in the areas located in the four corners of the screen.

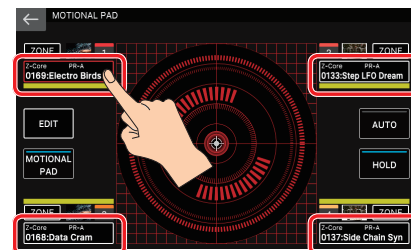

The TONE LIST screen appears.

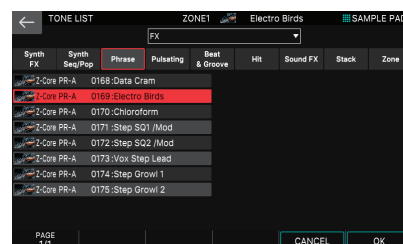

#### 3. Select a tone, and then select [E6] OK.

## Other Settings for Motional Pad

### 1. Press the [MOTIONAL PAD] button.

The MOTIONAL PAD screen appears.

### 2. Touch <EDIT>.

The MOTIONAL PAD EDIT screen appears.

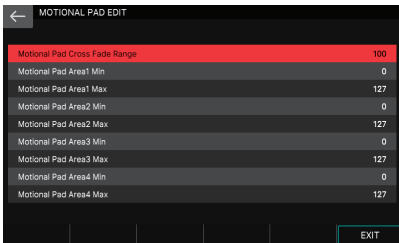

### 3. Select the desired parameter, and edit its value.

Parameter	Value	Explanation
Motional Pad Cross Fade Range	0-127	Specifies the extent to which the sound is mixed between adjacent areas.
Motional Pad Area1-4 Min	0-127	Specifies the minimum value for the variable range of each area.
Motional Pad Area1-4 Max	0-127	Specifies the maximum value for the variable range of each area.

### 4. When you have finished editing, select [E6] EXIT to return to the previous screen.



# 04: Editing

## Contents

<b>Editing a Scene (Zone)</b> .....	<b>42</b>	<b>Editing the Effects</b> .....	<b>50</b>
◇ <b>Editing the Overall Scene</b> .....	<b>42</b>	◇ <b>Basic Operation for Effect Editing</b> .....	<b>50</b>
Initializing a Scene (UTILITY) .....	<b>42</b>	◇ <b>Editing the Effects of Each Zone</b> .....	<b>50</b>
◇ <b>Editing a Zone</b> .....	<b>43</b>	◇ <b>Editing Effects Shared by All Zones</b> .....	<b>51</b>
Initializing a Zone (UTILITY) .....	<b>43</b>	◇ <b>Editing the Analog Filter</b> .....	<b>53</b>
◇ <b>Editing a Scene's Appearance</b> .....	<b>44</b>	Editing the Analog Filter Settings .....	<b>53</b>
◇ <b>Saving a Scene</b> .....	<b>44</b>	Using the Analog Filter .....	<b>54</b>
<hr/>		◇ <b>Editing the System-Wide Effects</b> .....	<b>55</b>
<b>Editing a Tone</b> .....	<b>45</b>	◇ <b>Editing the Sampling Input Effects</b> .....	<b>56</b>
◇ <b>Basic Tone Editing</b> .....	<b>45</b>	◇ <b>Applying Effects to the Sampler</b> .....	<b>56</b>
◇ <b>ZEN-Core Tone (TONE TYPE: Z-Core)</b> .....	<b>45</b>	Specifying the Sampler Output Destination .....	<b>56</b>
Editing in the TONE EDIT PRO Screen .....	<b>46</b>	◇ <b>Specifying the Output Destination for USB Input</b> .....	<b>57</b>
◇ <b>Drum Kit Tone (TONE TYPE: Drum)</b> .....	<b>46</b>	◇ <b>Specifying the Click Tone Output Destination</b> .....	<b>57</b>
◇ <b>V-Piano Tone (TONE TYPE: VPno)</b> .....	<b>47</b>	<hr/>	
◇ <b>Saving a Tone</b> .....	<b>48</b>	<b>Using the Mixer Screen</b> .....	<b>58</b>
◇ <b>Initializing a Tone (Tone Initialize)</b> .....	<b>48</b>	◇ <b>Adjusting the Pan and Volume in the MIXER Screen</b> .....	<b>58</b>
◇ <b>Initializing a Partial (Partial Initialize)</b> .....	<b>48</b>	Making ZONE EQ Settings in the MIXER Screen .....	<b>59</b>
◇ <b>Copying a Partial (Partial Copy)</b> .....	<b>49</b>	<hr/>	
◇ <b>Using the Edit Knobs</b> .....	<b>49</b>	<b>Recalling Scenes in the Order of Songs (Scene Chain)</b> .....	<b>60</b>
		◇ <b>Using Scene Chain</b> .....	<b>60</b>
		◇ <b>Creating a Chain Set</b> .....	<b>61</b>
		◇ <b>Editing a Chain Set</b> .....	<b>62</b>

# Editing a Scene (Zone)

## Editing the Overall Scene

Scene parameters are common to all zones, and apply to the entire scene.

1. **Select a scene.**
2. **Press the [MENU] button.**
3. **Touch <SCENE EDIT>.**

The MENU screen appears.

The SCENE EDIT screen appears.

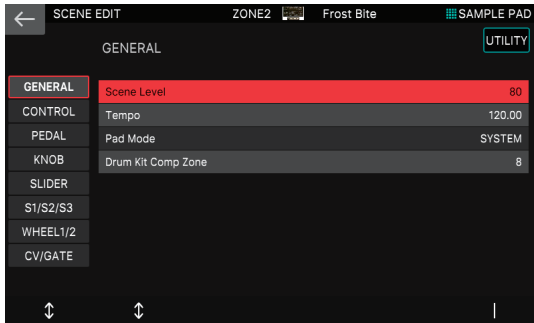

Menu	Explanation
[E1] knob	Scrolls up or down through the tabs.
[E2] knob	Scrolls the cursor up or down.
[E6] knob	Edits the value of the parameter selected by the cursor.
<UTILITY>	Accesses the UTILITY window.

4. **Select the desired parameter and edit its value.**

### NOTE

The edited scene is temporary. It is lost when you turn off the power or select another scene. If you want to keep the settings, save the scene (p. 44).

### Scene Parameter

Tab	Explanation
GENERAL	Specifies the scene volume and tempo.
CONTROL	Specifies the MIDI messages that control parameters when using Tone Control 1–4.
PEDAL	Specifies the MIDI messages that control parameters when using pedals connected to the PEDAL jacks.
KNOB	Specifies the MIDI messages that control parameters when using the control knobs with ASSIGN 1.
SLIDER	Specifies the MIDI messages that control parameters when using the sliders with ASSIGN 1.
S1/S2/S3	Specifies the MIDI messages that control parameters when using the [S1]–[S3] buttons.
WHEEL1/2	Specifies the MIDI messages that control parameters when using WHEEL 1 and 2.
CV/GATE	Specifies the MIDI messages that control external devices when using the CV OUT 1/2 and GATE OUT 1/2 jacks.

### MEMO

For details on the parameters, refer to "Parameter Guide" (PDF).

## Initializing a Scene (UTILITY)

1. **In the SCENE EDIT screen, touch <UTILITY>.**

The UTILITY window appears.

Menu	Explanation
SCENE INITIALIZE	Initializes all settings of the current scene.
SOUND CONTROL INITIALIZE	Initializes only the current scene's parameters that are related to sound control.

2. **Select the function that you want to execute, and then select [E6] SELECT.**

Alternatively, you can directly touch a menu item.

A confirmation message appears.

3. **Select [E5] OK.**

Initialization is executed, and you return to the SCENE EDIT screen.

If you decide to cancel, choose [E6] CANCEL.

## Editing a Zone

Zone parameters are the parameters related to the zones, and are set individually for each zone. There are 16 zones, and each zone has its own settings for volume (Level), equalizer (EQ), and Key Range (KBD) etc.

1. **Select a scene.**
2. **Press the [MENU] button.**  
The MENU screen appears.
3. **Touch <ZONE EDIT>.**  
The ZONE EDIT screen appears.

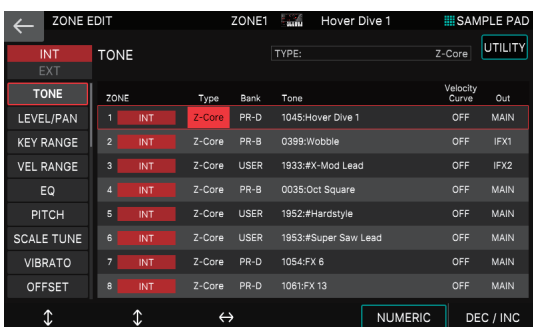

Menu	Explanation
[E1] knob	Scrolls up or down through the tabs.
[E2] knob	Scrolls the cursor up or down.
[E3] knob	Scrolls left or right through the parameters.
[E5] NUMERIC	Accesses the NUMERIC window.
[E6] knob	Edits the value of the parameter selected by the cursor.
<UTILITY>	Accesses the UTILITY window.

4. **Select the desired parameter, and edit its value.**

**NOTE**

The edited scene is temporary. It is lost if you turn off the power or select another scene. If you want to keep the edited settings, save the scene (p. 44).

### Zone Parameter

Tab	Explanation
<b>INT settings</b> (settings used when controlling the internal sound engine)	
TONE	Specifies each zone's assigned tone and output destination.
LEVEL/PAN	Specifies each zone's level, pan, send level, and MIDI receive settings.
KEY RANGE	Specifies each zone's Key Range settings.
VEL RANGE	Specifies each zone's velocity range settings.
EQ	Specifies each zone's equalizer (ZONE EQ) settings.
Pitch	Specifies each zone's pitch and portamento settings.
SCALE TUNE	Specifies each zone's scale tune settings.
VIBRATE	Specifies each zone's vibrato settings.
OFFSET	Specifies offset values for parameters such as cutoff and resonance.
MONO/POLY	Specifies each zone's mono/poly and bend settings.
PEDAL CTRL	Specifies each zone's connection with the pedals.
BEND CTRL	Specifies each zone's connection with the pitch bend lever.
S1S2S3 CTRL	Specifies each zone's connection with the [S1]–[S3] buttons.
ASSIGN KNOB	Specifies each zone's connection with the control knobs.
ASSIGN SLIDER	Specifies each zone's connection with the sliders.
VOICE RESERVE	Specifies the number of voices reserved for each zone.
MIDI Rx FILTER	Specifies the types of MIDI messages received by each zone.

Tab	Explanation
<b>EXT settings</b> (settings used when controlling an external sound module)	
NAME	Specifies the name of the external sound module being controlled.
OUT/PC	Specifies the channel and port for MIDI messages sent by each zone.
LEVEL/PAN	Specifies settings for the level, pan, and send level sent by each zone.
KEY RANGE	Specifies settings for the key range sent by each zone.
VEL RANGE	Specifies settings for the velocity range sent by each zone.
Pitch	Specifies pitch-related settings sent by each zone.
OFFSET	Specifies offset values for parameters such as cutoff and resonance sent by each zone.
MONO/POLY	Specifies mono/poly and bend settings sent by each zone.
PEDAL CTRL	Specifies pedal messages sent by each zone.
BEND CTRL	Specifies bend and wheel messages sent by each zone.
S1S2S3 CTRL	Specifies [S1]–[S3] button messages sent by each zone.
ASSIGN KNOB	Specifies control knob messages sent by each zone.
ASSIGN SLIDER	Specifies slider messages sent by each zone.

**MEMO**

- For details on the parameters, refer to "Parameter Guide" (PDF).
- Depending on the tone, some parameters might not have any effect even if edited.

## Initializing a Zone (UTILITY)

1. **In the ZONE EDIT screen, touch <UTILITY>.**

The UTILITY window appears.

Menu	Explanation
ZONE INITIALIZE	Initializes the zone parameters of the current zone.

2. **Select [E6] SELECT.**

Alternatively, you can touch the menu item directly. A confirmation message appears.

3. **Select [E5] OK.**

Initialization is executed, and you return to the ZONE EDIT screen.

If you decide to cancel, choose [E6] CANCEL.

## Editing a Scene's Appearance

Here you can use a dedicated screen to make various settings such as the appearance and a memo for each scene.

1. Select a scene.
2. Touch <EDIT>.

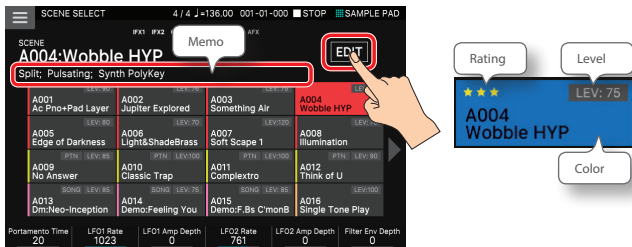

The EDIT screen appears.

Menu	Explanation
[E3] MEMO	Enter a memo that is shown below the scene name. You can enter up to 64 characters.
Scene Rating [E4] knob	Adds star symbols to the scene icon. You can add stars to rate your favorite scenes. (Range: 0–3)
Scene Color [E5] knob	Changes the color of the scene icon. (Range: 1–16)
Scene Level [E6] knob	Specifies the volume of the scene. This is the same as the "Scene Level" in the GENERAL tab of the scene parameters. (Range: 0–127) The Scene Level value is shown on the scene icon.
<WRITE>	Overwrites the settings onto the current scene.

3. Select the desired parameter, and edit its value.

To enter a memo, select [E3] MEMO and the RENAME screen appears.

Enter a memo as described in the directions for the RENAME screen (p. 13).

4. When you have finished editing, touch <WRITE>.

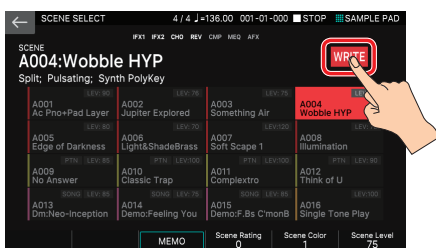

The settings are overwritten onto the current scene, and you return to the SCENE screen.

## Saving a Scene

The edited zone and tone settings, and the recorded data, are temporary. They will be lost if you turn off the power or select another scene or tone. If you want to keep your edited settings or recorded data, save them as follows.

### NOTE

When you save, the data previously located in the save-destination is overwritten.

1. Press the [WRITE] button.



The WRITE MENU screen appears.

2. Touch <SCENE>.

The SCENE WRITE screen appears.

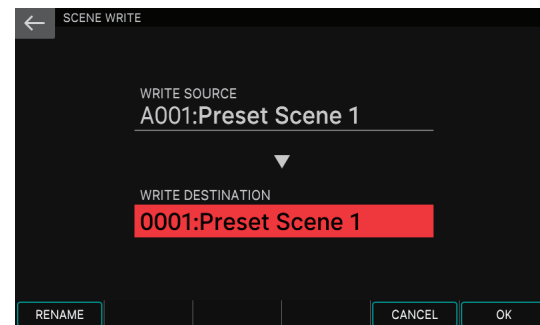

3. If you want to edit the name, select [E1] RENAME and edit the name.

Enter a name as described in the directions for the RENAME screen.

When you have finished editing the name, select [E6] OK to close the window.

4. Use the [VALUE] dial or the [DEC] [INC] buttons to select the save-destination.

5. Select [E6] OK.

A confirmation message appears.

If you decide to cancel, choose [E5] CANCEL.

6. Select [E5] OK.

The scene is saved.

### Items that are saved as scene data

The following settings and data are saved in the scene.

- Overall settings for the entire scene (scene parameters)
- Settings for each zone (zone parameters)
- Settings related to the appearance of a scene, such as memo and rating.
- Arpeggio settings
- Chord memory settings
- Rhythm pattern settings
- Pad settings
- Effect settings shared by all zones (IFX1, IFX2, REVERB, CHORUS, Analog Filter)
- Sequencer pattern data
- Sequencer group data
- Sequencer song data

# Editing a Tone

## Basic Tone Editing

Here's how to edit the tone that's assigned to a zone.

1. Select the current zone.
2. As described in "Selecting a Tone" (p. 23), select the tone that you want to edit.
3. Press the [MENU] button.
4. Touch <TONE EDIT>.

The appropriate TONE EDIT screen opens, depending on the "tone type" of the tone that's selected for the zone.

### NOTE

The edited tone is temporary. It is lost if you turn off the power or select another tone. If you want to keep the settings, save the tone (p. 48). An editing indicator is shown above or at the left of the tone name.



## ZEN-Core Tone (TONE TYPE: Z-Core)

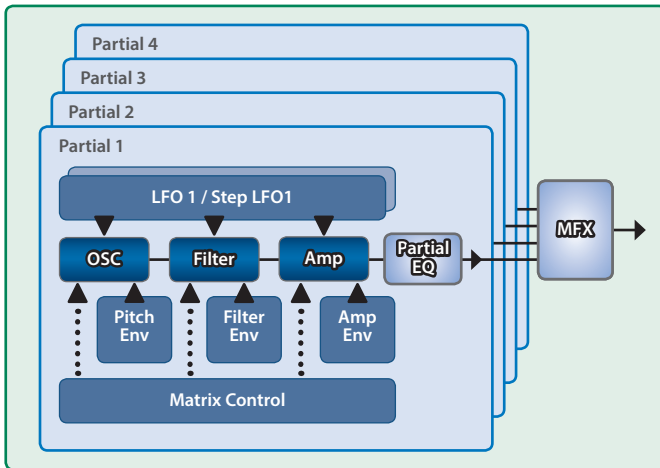

1. Select a tone whose tone type is "Z-Core," then press the [MENU] button and touch <TONE EDIT>.

The TONE EDIT ZOOM screen appears.

The TONE EDIT ZOOM shows the main parameters graphically and lets you edit them intuitively.



Menu	Explanation
[E1] knob	Scrolls up or down through the tabs.
[E2]–[E6] knob	Edit the corresponding parameters. (The corresponding parameters change depending on the cursor location.)
Partial Sw ON OFF	Turn a partial on/off. Partials that are off do not produce sound.
Partial Select Partial 1 Partial 2 Selected Deselected	Select a partial to edit. If multiple partials are selected, you can edit their parameter values simultaneously. * You can't deselect Partial Select for all partials.
<To PRO>	Accesses the TONE EDIT PRO screen.
<UTILITY>	Accesses the UTILITY window.

2. Move the cursor to the desired parameter and edit the value.

- You can touch an icon directly to edit parameters that are shown as button icons, or for Partial Sw and Partial Select.
- The screen shows the contents of the lowest-numbered partial that is selected by Partial Select.

Tab	Explanation Black: common / Blue: PRO screen only / Green: ZOOM screen only
COMMON	Settings for the entire tone.
STRUCTURE	Settings that specify how the partials are combined.
KEYBOARD	Settings for key range and velocity range.
OSC	Settings for the waveform that is the basis of the tone.
PITCH	Settings related to pitch.
PITCH ENV	Settings for the pitch envelope.
FILTER	Settings related to the filter.
FILTER ENV	Settings for the filter envelope.
AMP	Settings related to volume.
AMP ENV	Settings for the amp envelope.
LFO	Settings for the LFO that modulates the sound.
LFO1–2	Settings for the LFO waveform and modulation speed.
STEP LFO1–2	Settings for modulating the sound in 1–16 steps.
PARTIAL EQ	Settings for the equalizer of the partial.
OUTPUT	Settings related to output.
CONTROL	Settings for the controllers.
MATRIX CTRL1–4	Settings for matrix control 1–4.
MFX	Settings related to multi-effects.
MFX CONTROL	Settings for controlling MFX via MIDI.

\* For details on the tone parameters, refer to "Parameter Guide" (PDF).

## Editing in the TONE EDIT PRO Screen

The TONE EDIT PRO screen shows all parameters, allowing you to edit in greater detail.

### 1. In the TONE EDIT ZOOM screen, touch <To PRO>.

The TONE EDIT PRO screen appears.

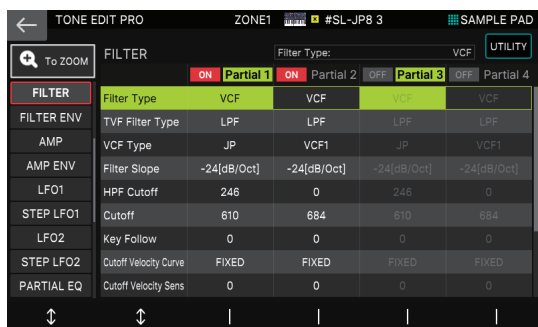

Menu	Explanation
[E1] knob	Scrolls up or down through the tabs.
[E2] knob	Scrolls the cursor up/down to select a parameter.
[E3]–[E6] knob	Edit the partial selected by the cursor separately for each partial. [E3]–[E6] correspond to Partial 1–4 respectively.
Partial Sw	Turn a partial on/off. Partial that are off do not produce sound.
Partial Select	Select a partial to edit. If multiple partials are selected, you can edit their parameter values simultaneously.
Selected Deselected	* You can't deselect Partial Select for all partials.
<To ZOOM>	Accesses the TONE EDIT ZOOM screen.
<UTILITY>	Accesses the UTILITY window.

### 2. Move the cursor to the desired parameter, and edit the value.

You can use the [INC] [DEC] buttons and the [VALUE] dial to edit the value while maintaining the value difference between partials.

## Drum Kit Tone (TONE TYPE: Drum)

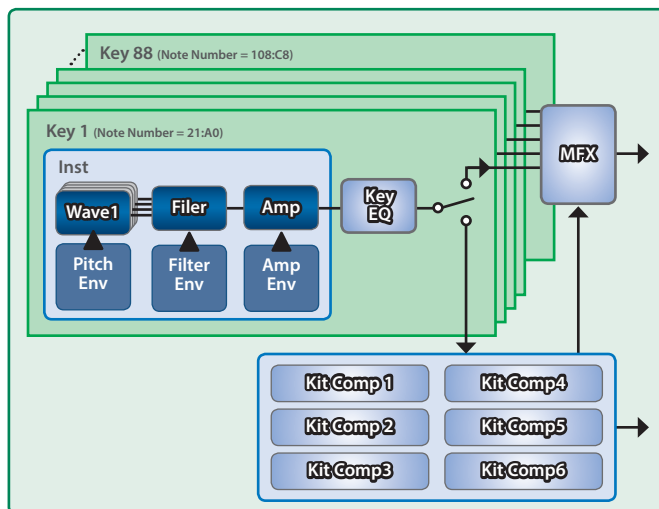

### 1. Select a tone whose tone type is “Drum,” then press the [MENU] button and touch <TONE EDIT>.

The TONE EDIT PRO screen appears. (Drum Kit tones use only the PRO screen.)

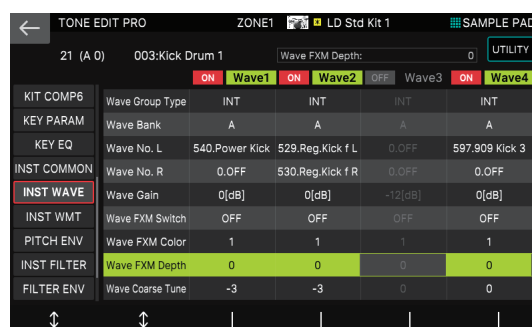

Menu	Explanation
[E1] knob	Scrolls up or down through the tabs.
[E2] knob	Scrolls the cursor up/down to select a parameter.
[E3]–[E6] knob	Edit the parameter that is selected by the cursor. In the “INST WAVE” tab and the “INST WMT” tab, [E3]–[E6] correspond to editing Wave 1–4 respectively.
Wave Sw	Turn the wave on/off. Waves that are off do not produce sound.
Wave Select	Select a wave to edit. If multiple waves are selected, you can edit their parameter values simultaneously.
Selected Deselected	* You can't deselect Wave Select for all waves.
<UTILITY>	Accesses the UTILITY window.

### 2. Move the cursor to “Current Note” and select the key that you want to edit.

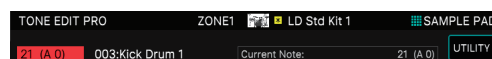

Drum Kit tones assign a different drum sound (instrument) to each of the 88 keys A0–C8. You can select and edit each key individually. The currently selected key is called the “Current Note,” and you can change the current note by pressing a key on the keyboard.

#### MEMO

You can also select the current note by pressing a key on the keyboard. In this case, there's no need to move the cursor.

### 3. Move the cursor to “Inst Number” and select an instrument.



Change the instrument if necessary. Instruments are preset drum sounds, and changing the instrument affects the parameters below the “INST COMMON” tab. It’s useful to select an instrument that’s close to what you have in mind, and then edit it individually.

### 4. Move the cursor to the desired parameter and edit the value.

Tab	Explanation
KIT COMMON	Settings for the entire kit.
KIT MFX	Settings for the multi-effect applied to the entire kit.
KIT MFX CTRL	Settings for controlling MFX via MIDI.
KIT COMP1–6	Settings for compressors 1–6 applied to the kit. * These are valid only when using a Drum Kit tone in a zone that is assigned as the Drum Kit Comp Zone.
KEY PARAM	Basic settings for each key.
KEY EQ	Equalizer settings for each key.
INST COMMON	Basic settings for each instrument.
INST WAVE	Settings for the waveform that is the basis of the instrument.
INST WMT	Settings for playing different instruments depending on velocity.
PITCH ENV	Settings for the pitch envelope.
INST FILTER	Settings related to the filter.
FILTER ENV	Settings for the filter envelope.
INST AMP	Settings related to volume.
AMP ENV	Settings for the amp envelope.

You can use the [INC] [DEC] buttons and the [VALUE] dial to edit the value while maintaining the value difference between waves.

## V-Piano Tone (TONE TYPE: VPno)

### NOTE

V-Piano tones can be selected only for ZONE 1.

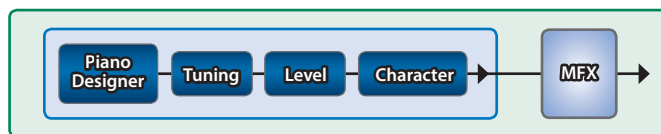

### 1. Select a tone whose tone type is “VPno,” press the [MENU] button and then touch <TONE EDIT>.

The TONE EDIT PRO screen appears. (V-Piano tones use only the PRO screen.)

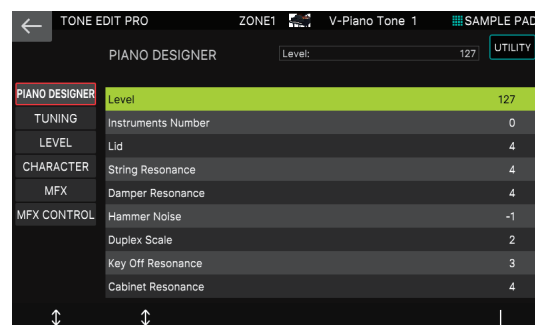

Menu	Explanation
[E1] knob	Scrolls up or down through the tabs.
[E2] knob	Scrolls the cursor up/down to select a parameter.
[E6] knob	Edits the parameter selected by the cursor.
<UTILITY>	Accesses the UTILITY window.

### 2. Move the cursor to the desired parameter and edit the value.

### 3. Edit the “TUNING,” “LEVEL,” and “CHARACTER” values for each key.

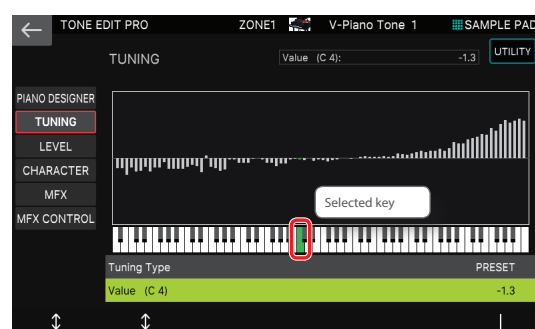

Play the keyboard to select a key. The currently selected key is indicated in green. Parameter values for each key are shown graphically.

## Saving a Tone

An edited tone is temporary. It is lost if you turn off the power or select another tone. If you want to keep the edited tone, save the tone.

### NOTE

When you save, the data that had been in the save-destination is overwritten.

### 1. Press the [WRITE] button.



The WRITE MENU screen appears.

### 2. Touch <TONE>.

The TONE WRITE screen appears.

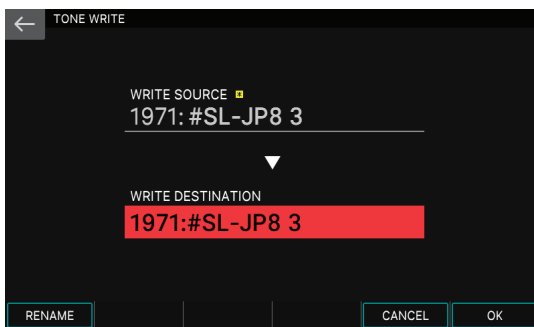

### 3. If you want to edit the name, select [E1] RENAME and edit the name.

Enter a name as described in the explanation of the RENAME screen.

When you have finished editing the name, select [E6] OK to close the window.

### 4. Use the [VALUE] dial or the [DEC] [INC] buttons to select the save-destination.

### 5. Select [E6] OK.

A confirmation message appears.

If you decide to cancel, choose [E5] CANCEL.

### 6. Select [E5] OK.

The tone is saved.

### NOTE

Never turn off the power while data is being saved.

## Initializing a Tone (Tone Initialize)

Here's how to initialize the settings of the current tone.

### 1. In the TONE EDIT screen, touch <UTILITY>.

The UTILITY window appears.

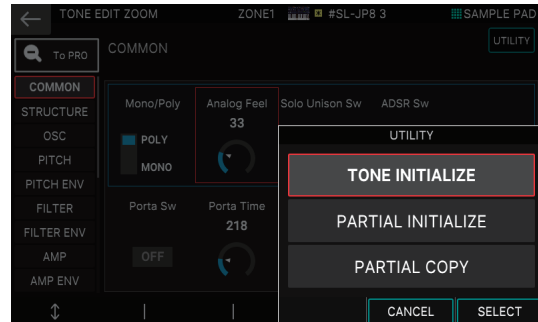

### 2. Touch <TONE INITIALIZE>.

A confirmation message appears.

If you decide to cancel, choose [E5] CANCEL.

### 3. Select [E5] OK.

The tone is initialized.

### NOTE

Never turn off the power while data is being saved.

## Initializing a Partial (Partial Initialize)

Here's how to initialize a partial (a key) of a ZEN-Core tone or Drum Kit tone.

### 1. In the TONE EDIT screen, touch <UTILITY>.

The UTILITY window appears.

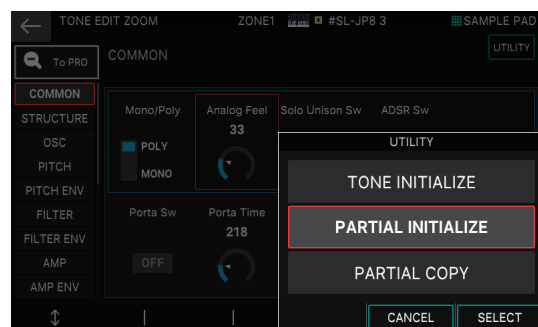

### 2. Touch <PARTIAL INITIALIZE>.

The PARTIAL INIT window appears.

### 3. Select the partial that you want to initialize.

In the case of a Drum Kit tone, select the key.

### 4. Select [E6] OK.

A confirmation message appears.

If you decide to cancel, choose [E5] CANCEL.

### 5. Select [E5] OK.

The partial is initialized.

### NOTE

Never turn off the power while initialization is in progress.



## Copying a Partial (Partial Copy)

Here's how to copy the settings of a partial (a key) in a ZEN-Core tone or Drum Kit tone.

### 1. In the TONE EDIT screen, touch <UTILITY>.

The UTILITY window appears.

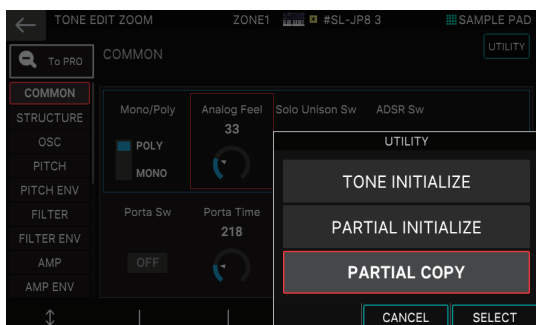

### 2. Select <PARTIAL COPY>.

The PARTIAL COPY window appears.

### 3. Select the copy-source (SOURCE) partial and the copy-destination (DEST) partial.

In the case of a Drum Kit tone, select the key.

### 4. Select [E6] OK.

A confirmation message appears.

If you decide to cancel, choose [E5] CANCEL.

### 5. Select [E5] OK.

The partial is copied.

## Using the Edit Knobs

In addition to editing in the TONE EDIT ZOOM screen, you can edit a tone by directly operating the knobs and buttons of the OSC section, FILTER section, and ENV/AMP section in the right side of the panel (p. 9).



#### MEMO

Knobs that are valid for editing are lit blue around their circumference.

# Editing the Effects

## Basic Operation for Effect Editing

The FANTOM is equipped with a variety of effect processors such as the effects for each tone (MFX, Partial EQ, Kit Comp), effects that can be set for each scene (IFX1, IFX2, Chorus, Reverb, Analog FX), and effects that can be set for the entire system (Master FX, sampling input effect).

### An example of routing for the internal sound engine's effects

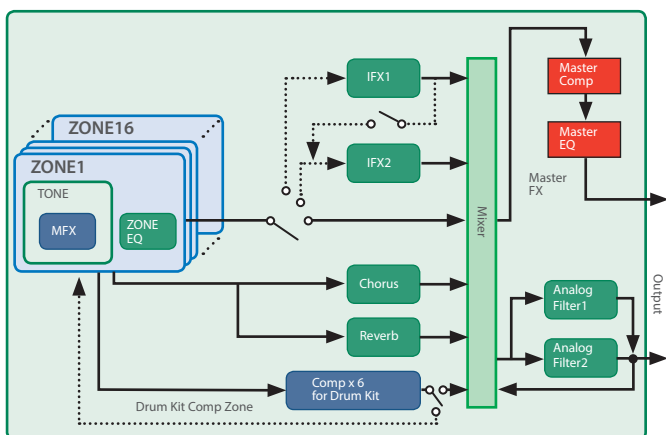

In addition to these effects for the internal sound engine, the "EFFECT" menu lets you make overall settings for effects and routing, including the sampling input effect, the on/off status of effects when the sampler pads are operated, and the output destinations of each section including USB and click.

### 1. Press the [MENU] button.

The MENU screen appears.

### 2. Touch <EFFECTS EDIT>.

The EFFECTS EDIT screen appears.

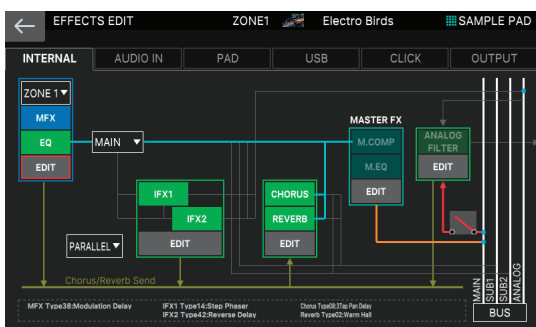

### 3. Touch the desired tab to switch screens as needed.

Menu	Explanation
INTERNAL	Settings for the internal sound engine's effects and routing.
AUDIO IN	Settings for the sampling input effect.
PAD	Settings for sampler pad routing.
USB	Settings for routing the input from USB.
CLICK	Settings for routing the click audio output.
OUTPUT	Settings for output routing.

## Editing the Effects of Each Zone

Here's how to edit the effects that can be specified for each zone, such as a tone's MFX or ZONE EQ.

### 1. In the EFFECTS EDIT screen, touch the INTERNAL tab.

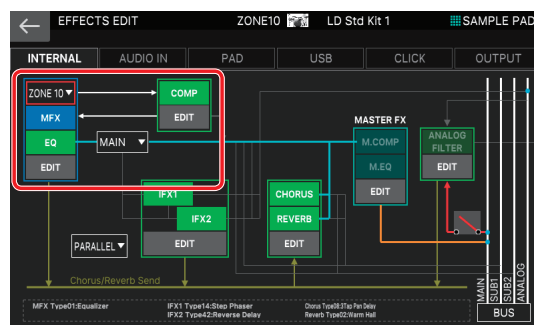

### 2. Select the zone that you want to edit.

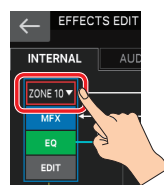

### Turning each effect on/off

### 3. In the screen, touch <MFX>, <EQ>, or <COMP> to switch the effect on/off.

### Editing the parameters

### 1. Touch <EDIT> of the section that you want to edit.

The EFFECTS EDIT ZOOM screen appears.

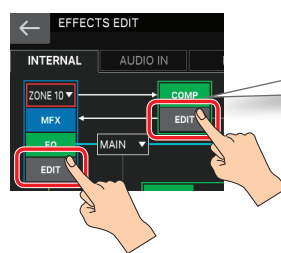

#### NOTE

The DRUM KIT COMP icon is shown if a Drum Kit tone is selected for a zone that is assigned as the Drum Kit Comp Zone.

The EFFECTS EDIT ZOOM screen appears.

### ZONE EFFECTS

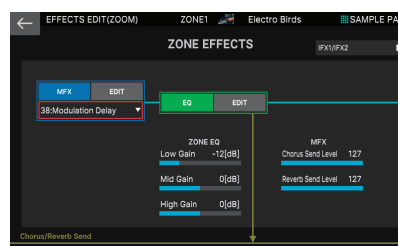

In this screen, you can edit the main parameters such as MFX on/off, change the effect type, adjust the ZONE EQ Gain, and adjust the Send Level from MFX.

## DRUM KIT COMP

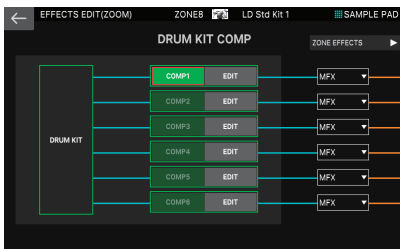

In this screen you can edit the main parameters for the six compressors provided for the drum kit, such as turning each on/off and specifying its output destination.

### NOTE

This is valid only for one specified zone (the zone specified as the Drum Kit Comp Zone).

2. Move the cursor to the desired parameter, and edit the value.
3. If you want to make detailed edits, touch <EDIT> in the section that you want to edit.

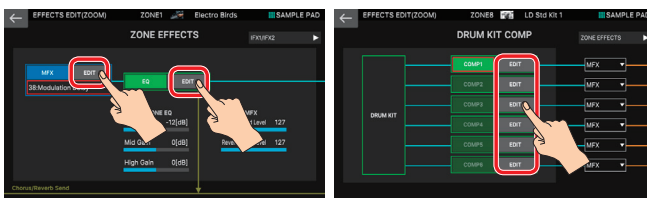

The EFFECT PRO EDIT screen appears.

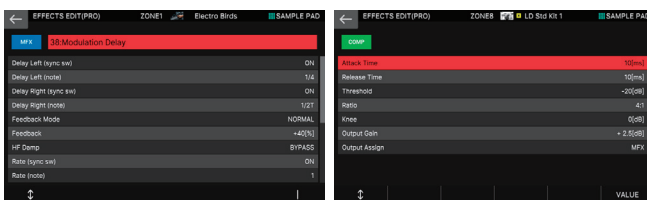

Menu	Explanation
[E1] knob	Scrolls the cursor up or down.
[E6] knob	Edits the parameter that is selected by the cursor.

### MEMO

These parameters can also be edited in the TONE EDIT PRO screen's MFX/KIT MFX/KIT COMP tab or ZONE EDIT's EQ tab.

4. Move the cursor to the desired parameter, and edit the value.

### NOTE

The edited effect settings are temporary. They will be lost if you turn off the power, or if you select another scene or tone. If you want to keep the settings, save the scene (ZONE EQ) or tone (MFX/KIT MFX/KIT COMP) respectively.

### MEMO

- In addition to editing the effects in the screen, you can also edit them by using the knobs in the EFFECTS section at the right of the panel (p. 9).
- For details on each parameter, refer to "Parameter Guide" (PDF).

## Editing Effects Shared by All Zones

Here's how to edit the effect units that are shared by all zones, such as IFX 1-2, CHORUS, and REVERB.

1. In the EFFECTS EDIT screen, touch the <INTERNAL> tab.

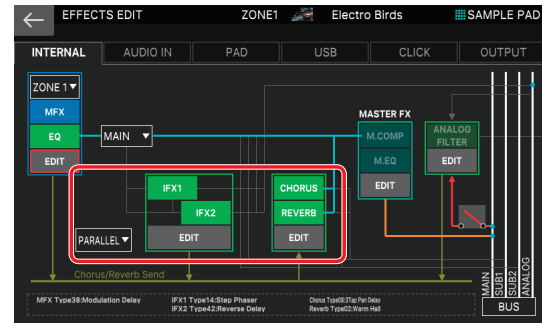

2. Select a zone.

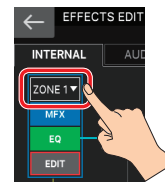

Turning each effect on/off

3. In the screen, touch <IFX1>, <IFX2>, <CHORUS>, or <REVERB> to turn each effect on/off.

Editing the parameters

**NOTE**

The edited effect settings are temporary. They will be lost if you turn off the power, or if you select another scene. If you want to keep the settings, save the scene.

1. In the section that you want to edit, touch <EDIT>.

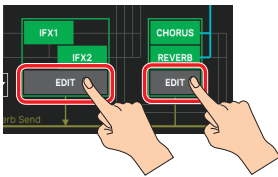

The EFFECTS EDIT ZOOM screen appears.

**IFX1/IFX2**

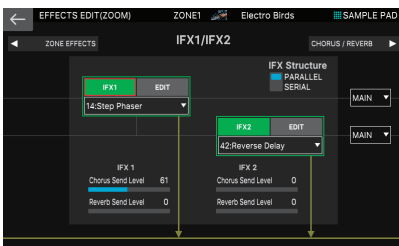

In this screen you can edit major parameters such as the IFX on/off status, the IFX connection order, the effect type, and the send level and output destination from the IFX.

**CHORUS/REVERB**

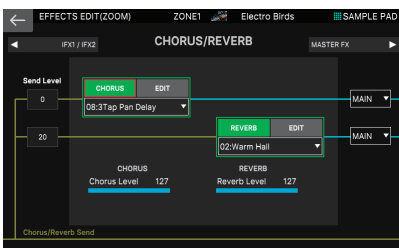

In this screen, you can edit major parameters such as the CHORUS/REVERB on/off status, the send levels from the zone, the effect type, the effect level, and the output destination.

2. Move the cursor to the desired parameter, and edit the value.
3. If you want to make detailed edits, touch <EDIT> in the section that you want to edit.

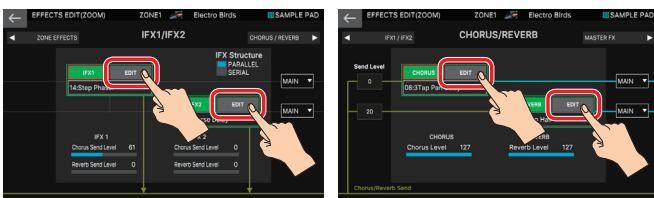

The EFFECT PRO EDIT screen appears.

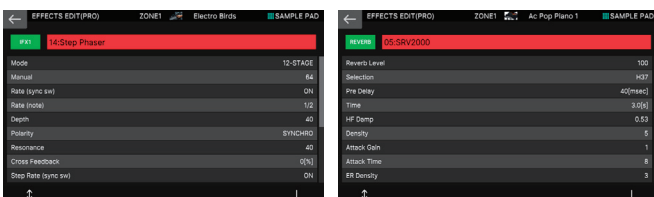

Menu	Explanation
[E1] knob	Scrolls the cursor up or down.
[E6] knob	Edits the value of the parameter selected by the cursor.

4. Move the cursor to the desired parameter, and edit the value.

## Editing the Analog Filter

The FANTOM is equipped with an analog filter that provides a wide range of sound-shaping possibilities. The analog filter features a stereo design, and by changing the routing you can flexibly connect a variety of outputs to the analog filter.

**MEMO**

- Analog filter settings are saved in the scene.
- Internally, the analog filter consists of OVERDRIVE and FILTER sections.

Section	Explanation
OVERDRIVE	Adjusts the depth of distortion.
FILTER	An analog filter with five types.

For details on the parameters, refer to "Parameter Guide" (PDF).

## Editing the Analog Filter Settings

In this example, the output from the tone of one zone is processed by the analog filter, and then output together with the sound of the other zones from the MAIN OUT jacks.

### 1. Select a tone for the current zone.

In order to make the effect easier to understand, we make settings so that only the current zone is heard by itself without using any layering. As the tone, let's select a synth lead sound.

### 2. Press the [MENU] button.

The MENU screen appears.

### 3. Touch <EFFECTS EDIT>.

The EFFECTS EDIT screen appears.

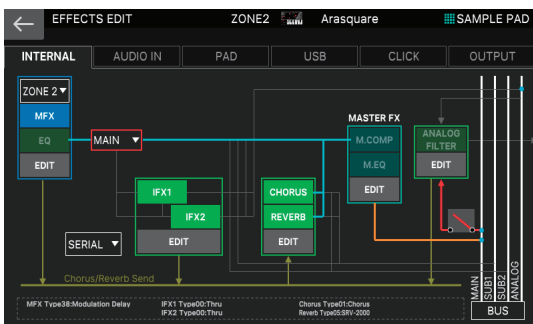

In the current routing, the output of ZONE 2 (which is the current zone) is connected to MASTER FX and then output directly from the MAIN OUT jacks.

### 4. Set the Zone Output Assign of ZONE 2 to "AFX."

The output of ZONE 2 is connected to the analog filter.

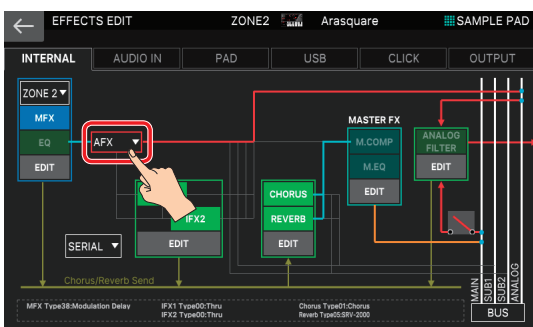

## Turning the Analog Filter on/off

### 5. In the screen, touch <ANALOG FILTER> to turn the effect on/off.

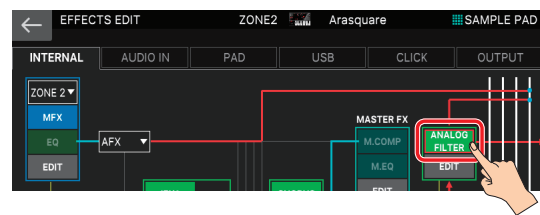

The OVERDRIVE and the FILTER inside the analog filter both turn on/off simultaneously.

### 6. In the ANALOG FILTER section, touch <EDIT>.

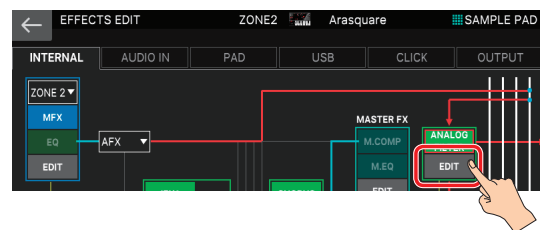

The EFFECTS EDIT (ZOOM) screen appears.

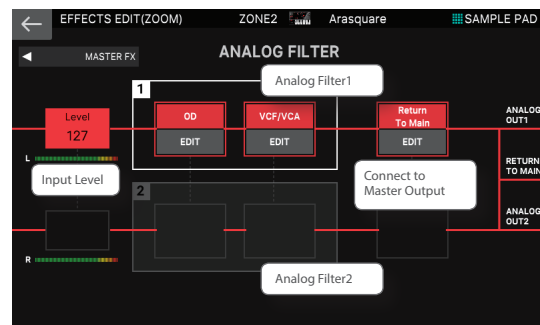

In this screen, you can turn each section on/off, adjust the input level, and specify the output to the MAIN OUT jacks.

### 7. Move the cursor to the desired parameter, and edit the value.

**NOTE**

The parameters of Analog Filter 2 cannot be edited. They always reflect the same values as Analog Filter 1.

**MEMO**

The output of Analog Filter 1 is always output from the ANALOG FILTER OUT 1 jack. Likewise, the output of Analog Filter 2 is always output from the ANALOG FILTER OUT 2 jack. In addition to this, you can use the <Return To Main> switch to specify whether the output is returned to MASTER OUT.

**8. If you want to make detailed edits, touch <EDIT> in the section that you want to edit.**

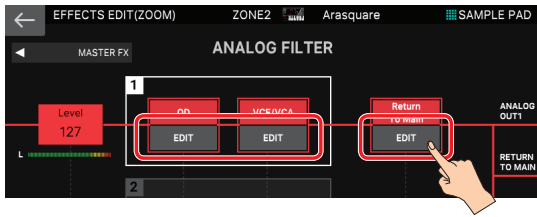

The EFFECT PRO EDIT screen appears.



Menu	Explanation
[E1] knob	Scrolls the cursor up or down.
[E6] knob	Edits the corresponding parameter. (The corresponding parameter changes depending on the position of the cursor.)

Operations using the [E1]–[E6] knobs are not available in the ANALOG FILTER RETURN TO MAIN screen.

**9. Move the cursor to the desired parameter, and edit the value.**

**NOTE**

The edited effect settings are temporary. They will be lost if you turn off the power, or if you select another scene. If you want to keep the settings, save the scene.

**Using the Analog Filter**

You can edit the analog filter settings even while you are playing.

**1. While playing, press the [ANALOG FILTER] button.**



The EFFECT PRO EDIT screen for ANALOG FILTER appears.



**2. Edit the desired parameters.**

**MEMO**

The edit knobs in the right side of the panel are normally used to edit tone parameters, but only when the ANALOG FILTER screen is shown you can use them to directly edit some of the analog filter parameters. The circumference of the available edit knobs is lit red.



**3. Press the [ANALOG FILTER] button to return to the previous screen.**

## Editing the System-Wide Effects

Here's how to edit the MASTER FX (M.COMP, M.EQ) that are common to the entire system.

1. In the EFFECTS EDIT screen, touch the INTERNAL tab.

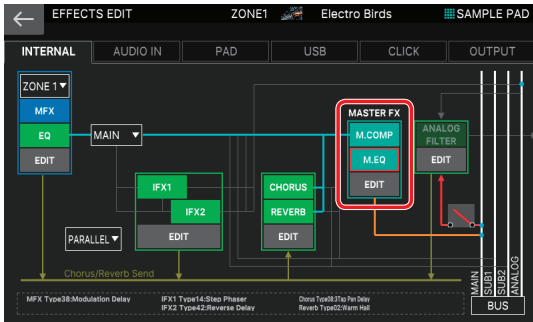

2. Select a zone.

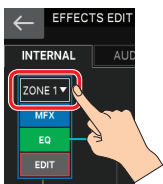

Turning each effect on/off

3. In the screen, touch <M.COMP> or <M.EQ> to turn the effect on/off.

Editing the parameters

1. In the section that you want to edit, touch <EDIT>.

The EFFECTS EDIT ZOOM screen appears.

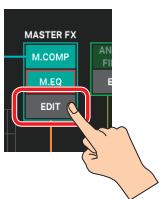

The EFFECTS EDIT ZOOM screen appears.

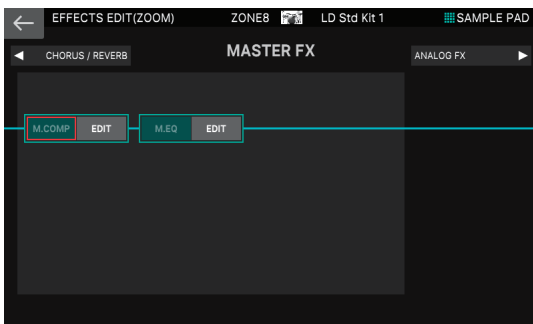

In this screen, you can edit major parameters such as the M.COMP/M.EQ on/off status, the connection with the Analog Filter, and the output destination for master output.

### MEMO

You can also access this screen by pressing the panel's [MASTER FX] button.

2. Move the cursor to the desired parameter, and edit the value.
3. If you want to make detailed edits, touch <EDIT> in the section that you want to edit.

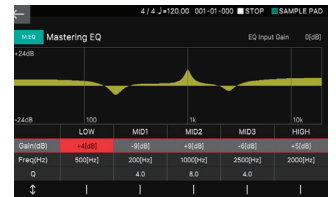
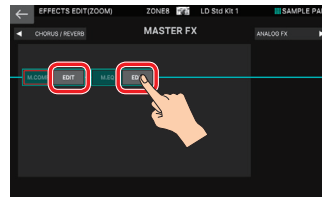

Menu	Explanation
[E1] knob	Scrolls the cursor up or down.
[E6] knob (M.COMP)	Edits the parameter that is selected by the cursor.
[E2]–[E6] knob (M.EQ)	Edits the corresponding parameter. (The corresponding parameter changes depending on the position of the cursor.)

4. Move the cursor to the desired parameter, and edit the value.

### NOTE

The edited effect settings are temporary. They will be lost if you turn off the power, or if you select another scene. If you want to keep the settings, save the system settings.

## Editing the Sampling Input Effects

Here's how to edit the effects that are applied to the audio input when you sample.

1. In the EFFECTS EDIT screen, touch the AUDIO IN tab.

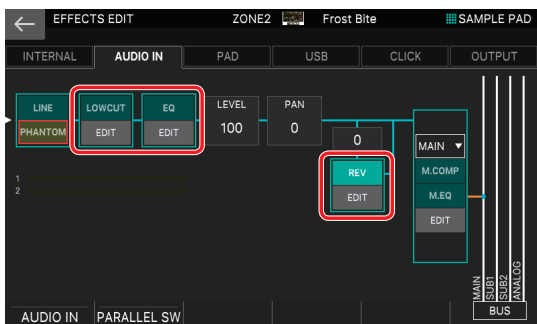

In this screen, you can turn the effects on/off, and edit the level, pan, and output destination settings, as well as make various sampling-related settings. For details on the parameters not related to effects, refer to "Sampling" (p. 67).

### Turning each effect on/off

2. In the screen, touch <LOWCUT>, <EQ>, or <REV> to turn each effect on/off.

### Editing the parameters

1. In the section that you want to edit, touch <EDIT>.

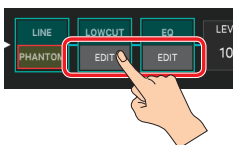

The EFFECTS EDIT PRO screen appears.

Menu	Explanation
[E1] knob	Scrolls the cursor up/down.
[E6] knob	Edits the parameter selected by the cursor.

#### MEMO

For details, refer to "Parameter Guide" (PDF).

## Applying Effects to the Sampler

The sampled sounds are assigned to pads [1]–[16], and for each pad you can specify whether it is connected to MASTER FX (M.COMP, M.EQ).

1. In the EFFECTS EDIT screen, touch the PAD tab.

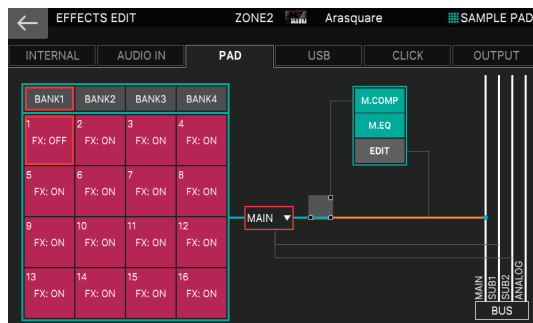

In this screen, you can also specify the sample output destination and make settings for M.COMP and M.EQ.

For details, refer to "Editing the System-Wide Effects" (p. 55).

2. Touch one of <BANK1>–<BANK4> to select a bank.
3. Touch the box of the pad to which you want to apply effects. The cursor moves.
4. Use the [VALUE] dial or the [DEC] [INC] buttons to specify "FX:ON."

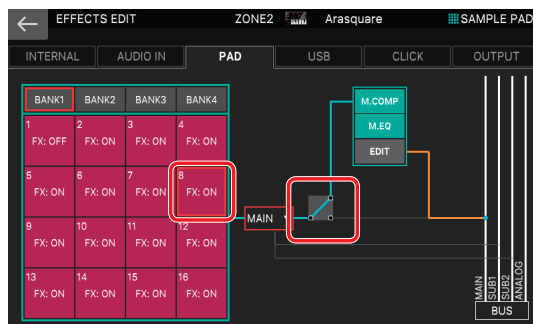

In this example, BANK 1 Pad 8 is connected to MASTER FX.

5. Repeat steps 2–4 to connect the desired pads to MASTER FX.

## Specifying the Sampler Output Destination

Here's how to specify the output destination for the entire sampler.

1. In the EFFECTS EDIT screen, touch the PAD tab.
2. Select the output destination for the entire sampler (Sample Output Assign).

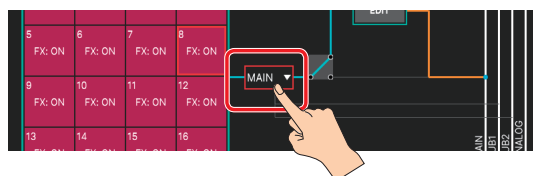

The output destination changes according to this setting.



## Specifying the Output Destination for USB Input

The FANTOM can input three stereo pairs of audio signals via its USB COMPUTER port. Of these, the output destination of USB SUB 1 is fixed as the SUB OUT 1 jacks, and the output destination of USB SUB2 is fixed as the SUB OUT 2 jacks, but you can choose the output destination jacks to which USB MASTER is routed.

1. In the EFFECTS EDIT screen, touch the <USB> tab.

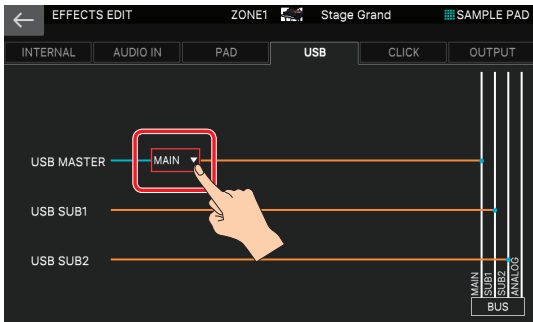

2. Select the USB MASTER output destination (USB Audio Input Destination 1).

The output destination changes according to this setting.

## Specifying the Click Tone Output Destination

Here's how to specify the output destination for the click that is used when recording into the sequencer or when sampling.

1. In the EFFECTS EDIT screen, touch the <CLICK> tab.

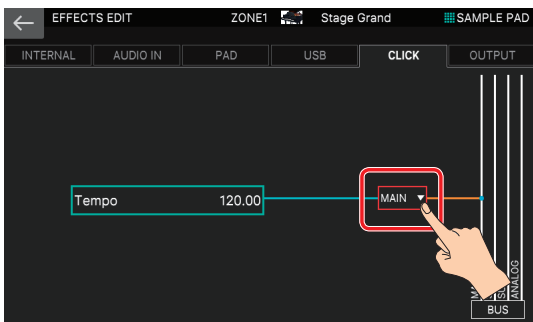

In this screen you can also set the tempo.

2. Select the click tone output destination (Click Output Assign).

The output destination changes according to this setting.

# Using the Mixer Screen

## Adjusting the Pan and Volume in the MIXER Screen

The MIXER screen provides unified access to frequently-edited parameters such as each zone's pan, level, and effects. This screen is ideal when you want to adjust the major parameters while maintaining the balance between zones.

### 1. Press the [MENU] button.

The MENU screen appears.

### 2. Touch <MIXER>.

The MIXER screen appears.

### 3. Edit the parameters as needed.

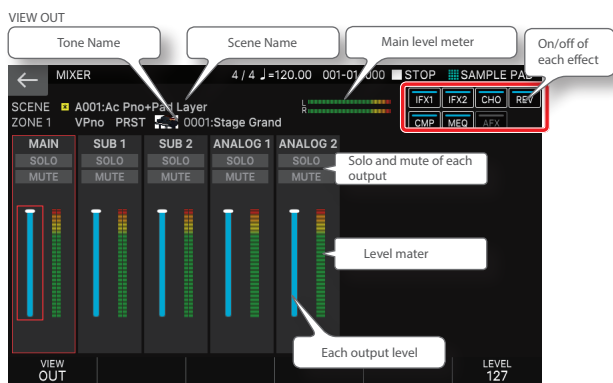
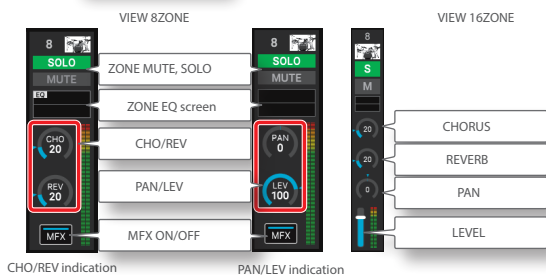
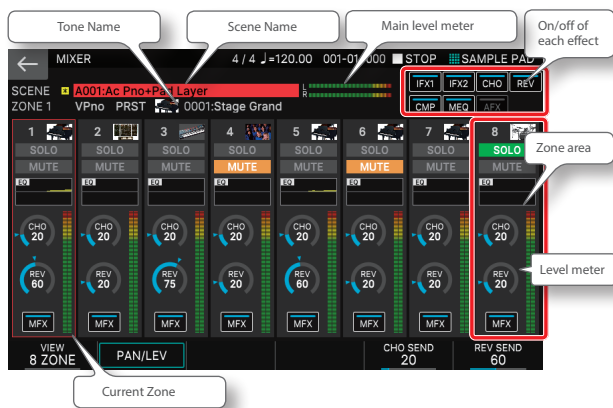

Parameter	Value	Explanation
PAGE [E1] knob	8 ZONE	Shows 8 zones.
	16 ZONE	Shows 16 zones.
	OUT	Shows the volume of MAIN, SUB, and ANALOG output.
[E2]	PAN/LEV, CHO/REV	Switches the indication in the zone area.
CHO SEND [E5] knob *1	0-127	Specifies the chorus send amount of the current zone.
REV SEND [E6] knob *1	0-127	Specifies the reverb send amount of the current zone.

Parameter	Value	Explanation
PAN [E5] knob *2	L64-R63	Specifies the pan (stereo position) of the current zone.
LEVEL [E6] knob *2	0-127	Specifies the level (volume) of the current zone.
LEVEL [E6] knob *3	0-127	Specifies the level of MAIN, SUB, and ANALOG output.
<MFX>	OFF, ON	Turns MFX on/off for each zone.
<IFX1>, <IFX2>, <CHO>, <REV>, <CMP>, <MEQ>, <AFX>	OFF, ON	Turn each effect on/off.
<SOLO>	OFF, ON	Solo setting for each zone.
<MUTE>	OFF, ON	Mute setting for each zone.
<TONE No.>	-	Selects the tone of each zone.

\*1 When the [E2] indication is PAN/LEV

\*2 When the [E2] indication is CHO/REV

\*3 When the [E1] indication is VIEW OUT

#### NOTE

The "solo" and "mute" settings that can be edited in the MIXER screen refer to "zone solo and mute." Be aware that these are different functions than the "track solo and mute" that are accessed in the PATTERN screen, and operate independently. Zones that are muted in the MIXER screen do not sound when you play the keyboard, but muting a zone in the PATTERN screen does not affect how it can be played by the keyboard.

#### MEMO

By using the PAD MODE Zone Solo and Zone Mute functions, the "solo" and "mute" settings of the MIXER screen can also be operated by pressing pads (p. 76).

## Making ZONE EQ Settings in the MIXER Screen

A simplified EQ curve is shown in the ZONE EQ area, and from here you can access an edit screen and edit the ZONE EQ settings.

1. In the MIXER screen, touch the ZONE EQ field of the zone whose EQ you want to edit.

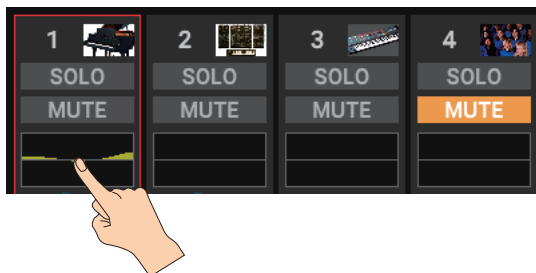

The ZONE EQ screen appears.

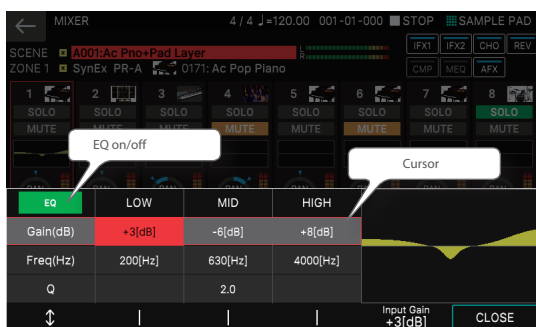

2. Edit the parameters as necessary.

Parameter	Value	Explanation
<EQ>	OFF, ON	Turns the ZONE EQ on/off.
[E1] knob	-	Moves the cursor up/down.
[E2]–[E4] knob	-	Edit the corresponding parameters depending on the cursor position. For the example shown in the illustration above, [E2] corresponds to LOW Gain, [E3] to MID Gain, and [E4] to HIGH Gain respectively.
Input Gain [E5] knob	-24–+24dB	Specifies the input gain.
[E6] CLOSE	-	Closes the screen.

### MEMO

For details on the ZONE EQ parameters, refer to “Parameter Guide” (PDF).

# Recalling Scenes in the Order of Songs (Scene Chain)

## Using Scene Chain

Use the SCENE CHAIN function when you want to recall scenes in the order of the songs that you'll be playing live.

A scene chain lets you specify the desired order of the scenes that you'll be using, without changing the numbers of the scenes themselves. The order of scenes can be saved as a chain set, and by switching the chain set you can change the order of the scenes.

### 1. Press the [SCENE CHAIN] button.

The SCENE CHAIN screen appears.

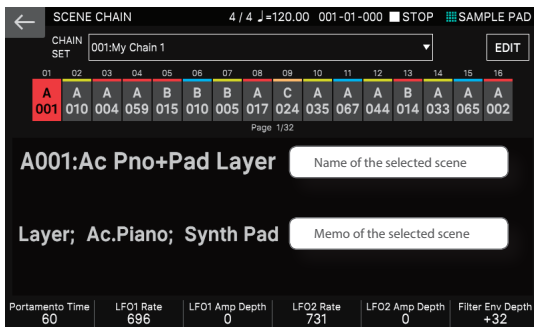

### 2. Touch the "CHAIN SET" name.

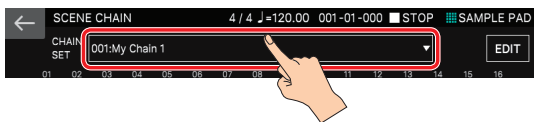

### 3. Switch chain sets.

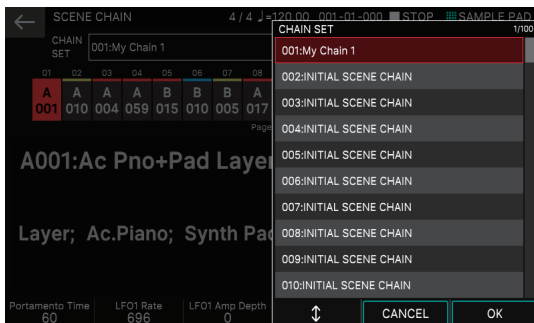

Menu	Explanation
[E4] knob	Scrolls up/down to select a chain set.
[E5] CANCEL	Cancels.
[E6] OK	Selects a chain set.

Parameter	Value	Explanation
CHAIN SET	001-100	Chain set number.

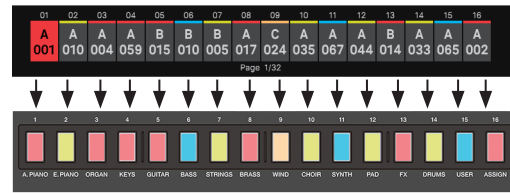

- You can also select a scene by directly touching a scene icon in the screen.
- You can also use the [INC] [DEC] buttons, [◀] [▶] buttons, [VALUE] dial, and a footswitch (p. 10) to select scenes.
- The icon of the selected scene is highlighted.
- Up to 512 scenes (16 x 32 pages) can be registered in a chain set. If more than 16 scenes are registered, a ◀▶ symbol is shown at each end of the scene icon in the screen. Touch the ▶ (◀) symbol to switch to the next (previous) page.

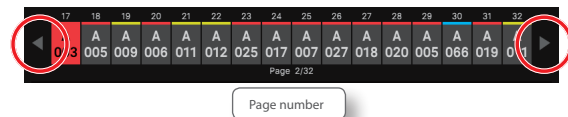

### 4. Press a tone category button [1]–[16] to select a scene.

The 16 scenes arranged horizontally in the screen correspond to tone category buttons [1]–[16] respectively.

## Creating a Chain Set

Here's how to create an original chain set.

### 1. Press the [SCENE CHAIN] button.

The SCENE CHAIN screen appears.

### 2. Touch the <CHAIN SET> name to switch to an empty chain set.

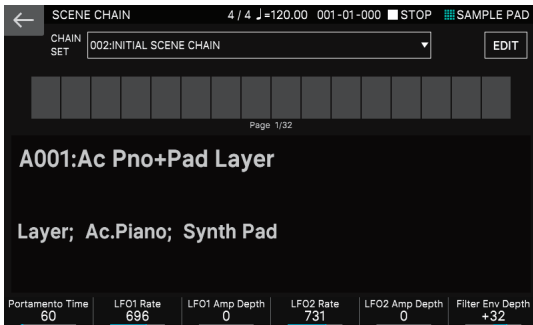

### 3. Touch <EDIT>.

The SCENE CHAIN EDIT screen appears.

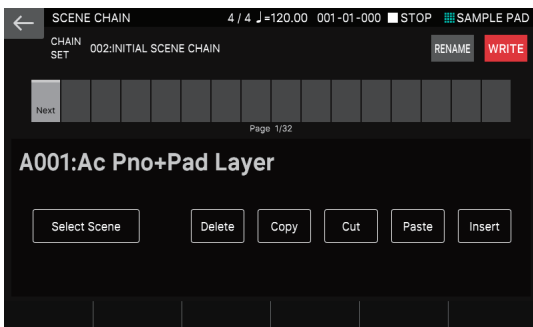

### 4. Touch <Select Scene>.

The SCENE SELECT screen appears.

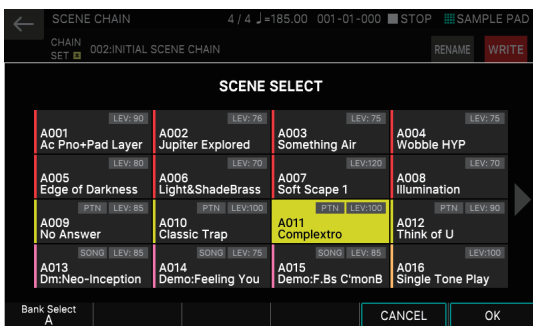

Menu	Explanation
[E1] knob	Switches the scene bank.
[E5] CANCEL	Cancels.
[E6] OK	Confirms the selected scene.

### 5. Highlight the scene that you want to register.

### 6. Select [E6] OK to confirm the selected scene.

You return to the SCENE CHAIN EDIT screen.

Note that the selected scene is registered as the first scene.

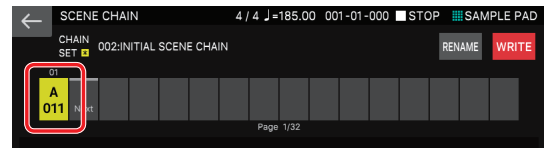

If you want to re-select a different scene for the registered position, you can touch <Select Scene> from this state, and re-select the scene.

### 7. To register the second scene, touch the box that contains the word <Next>.

The position to be registered moves one place to the right, and the Next box is highlighted.

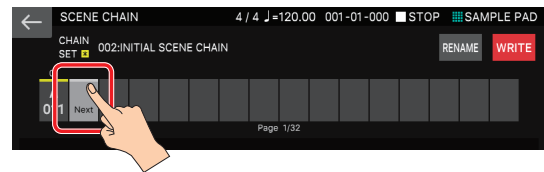

### 8. Repeat steps 4–6 to register the necessary scenes.

Scenes are registered consecutively from the left edge toward the right. Register as many scenes as necessary. Up to 512 scenes can be registered in a chain set.

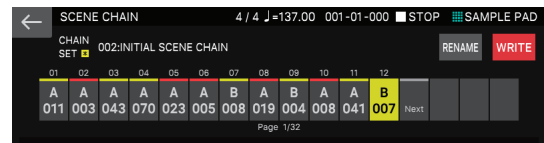

### 9. If you want to edit the name of the chain set, touch <RENAME> and edit the name.

When you have edited the name, select [E6] OK to close the window.

### 10. To save the scene, touch <WRITE>.

The chain set is saved, and you return to the SCENE CHAIN screen.

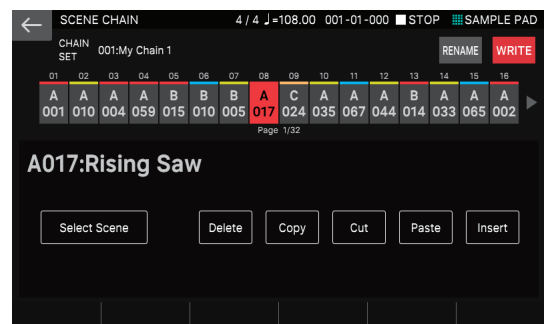

#### NOTE

When you save, the data previously located in the save-destination is overwritten.

## Editing a Chain Set

Here's how to edit the arrangement of a previously-created chain set.

### 1. Press the [SCENE CHAIN] button.

The SCENE CHAIN screen appears.

### 2. Select the chain set that you want to edit.

### 3. Touch <EDIT>.

The SCENE CHAIN EDIT screen appears.

Touch the box at the position that you want to edit, highlighting it.

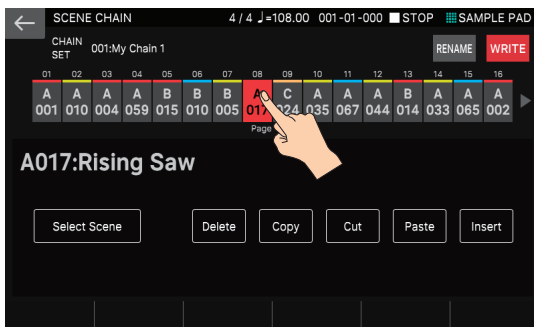

- You can use the [◀] [▶] buttons to move the highlighted box.

### 4. Touch the menu icons in the screen to edit the chain set.

Menu	Explanation
<Select Scene>	Re-selects the highlighted scene, replacing it with a different scene.
<Delete>	Deletes the highlighted scene.
<Copy>	Copies the highlighted scene.
<Cut>	Cuts the highlighted scene.
<Paste>	Overwrites the copied or cut scene onto the highlighted position.
<Insert>	Inserts the copied or cut scene at the highlighted position.

- You can use the [INC] [DEC] buttons or the [VALUE] dial to directly change the number of the highlighted scene.
- You can highlight multiple boxes by holding down the [SHIFT] button and using the [◀] [▶] buttons or touching a box.

### 5. When you have finished editing, touch <WRITE> to save the chain set.

#### NOTE

When you save, the data previously located in the save-destination is overwritten.

# 05: Sampler

## Contents

<b>Playing Samples</b> .....	<b>64</b>	<b>Editing a Sample</b> .....	<b>70</b>
◇ Pressing Pads to Play Samples.....	64	◇ Using Quick Edit.....	70
◇ Sustaining the Sample Playback (Hold).....	64	◇ Using Wave Edit.....	70
◇ Switching Banks.....	64	◇ Using the Sample Utility Functions.....	71
◇ Moving/Copying a Sample.....	65	Renaming the Sample	
Moving a Sample.....	65	(RENAME).....	71
Copying a Sample.....	65	Cutting Unwanted Regions from the Sample	
◇ About the SAMPLE PAD Screen.....	65	(TRUNCATE).....	71
		Deleting a Sample (DELETE).....	72
		Deleting All Samples	
<b>Sampling</b> .....	<b>66</b>	(DELETE ALL).....	72
◇ Preparing for Sampling.....	66	Exporting the Sample in WAV Format (EXPORT WAV) ..	72
Specifying the Input Volume (Input Setting).....	66	Exporting All Samples in WAV Format	
◇ Sampling.....	67	(EXPORT ALL WAV).....	72
◇ Importing an Audio File.....	68		

# Playing Samples

The FANTOM can audio-record (sample) the sound of your keyboard performance or an audio input such as an audio device or mic. You can press the pads to record the recorded samples.

## Pressing Pads to Play Samples

Here we explain how to use pads [1]–[16] to play sampled sounds (the sample pad function).

Before you continue, select “SAMPLE PAD” as the pad function as described in “Assigning Convenient Functions to the Pads (PAD MODE)” (p. 74).

### 1. Press a pad [1]–[16].



The sample plays.

You can also press multiple pads simultaneously to play them.

Since an unlit pad contains no sample, pressing it will not produce sound.

#### MEMO

The number of samples that can play back simultaneously is a maximum of eight for mono samples and a maximum of four for stereo samples.

## Sustaining the Sample Playback (Hold)

### 1. While you hold down a pad, press the [HOLD] button.



The sample continues playing even after you take your finger off the pad. To stop the sample, press the pad once again.

#### MEMO

The hold function is available only for samples whose “GATE” parameter is turned on (p. 70).

#### If the sound won't stop?!

Rapidly press the [HOLD] button four times in succession. This stops all sounds being played by the pads.

## Switching Banks

The samples are assigned to four banks that each contain 16 samples. By switching banks, you can change the samples that are assigned to each pad.

### 1. Press the [BANK] button.



The PAD BANK screen appears.

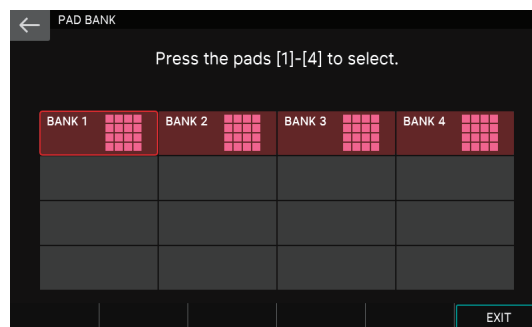

### 2. Press a pad [1]–[4] to select a bank.

The pad number corresponds to the bank number. When a bank is selected, you automatically return to the previous screen.

#### MEMO

You can also select a bank by directly touching an icon in the PAD BANK screen.



## Moving/Copying a Sample

You can move or copy a sample to another pad.

### Moving a Sample

1. While holding down the pad that contains the sample you want to move, press the [CLIP BOARD] button.



2. While holding down the [CLIP BOARD] button, press the move-destination pad.

The sample is moved.

- \* If there is a sample in the move-destination pad, the message "Overwrite?" appears. Press [E5] OK if you want to overwrite, or press [E6] CANCEL if you want to cancel.

### Copying a Sample

1. While holding down the [SHIFT] button and the pad that contains the sample you want to copy, press the [CLIP BOARD] button.

2. While holding down the [CLIP BOARD] button, press the copy-destination pad.

The sample is copied.

- \* If there is a sample in the copy-destination pad, the message "Overwrite?" appears. Press [E5] OK if you want to overwrite, or press [E6] CANCEL if you want to cancel.

## About the SAMPLE PAD Screen

In the SAMPLE PAD screen, you can view information about the currently selected bank and the samples that are assigned to each pad in that bank.

1. Hold down the [SHIFT] button and press the [SAMPLING] button.

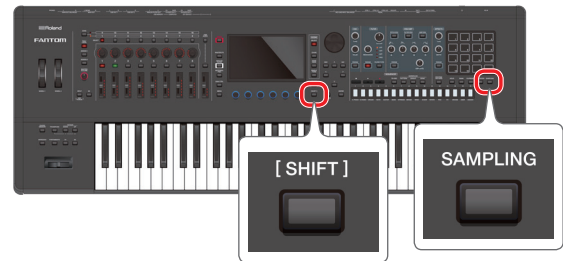

The SAMPLE PAD screen appears.

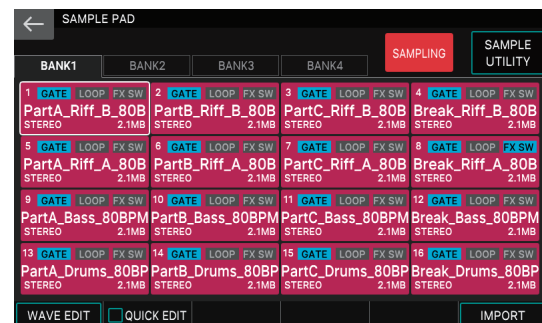

Menu	Explanation
[E1] WAVE EDIT	Accesses the WAVE EDIT screen (p. 70).
[E2] QUICK EDIT	Accesses the QUICK EDIT screen (p. 70).
[E6] IMPORT	Accesses the IMPORT screen (p. 68).
<BANK1-4>	Switch banks (p. 64).
<SAMPLING>	Accesses the SAMPLING STANDBY screen (p. 66).
<SAMPLE UTILITY>	Accesses the SAMPLE UTILITY screen (p. 71).

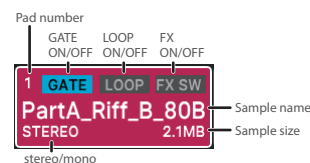

# Sampling

The FANTOM lets you create samples by sampling the following sounds.

- Keyboard performance
- Sound input from MIC/LINE INPUT jacks 1, 2 (an audio device or microphone)
- Sound input from the USB COMPUTER port

## Preparing for Sampling

### 1. As necessary, connect the device that you want to sample (an audio device or mic) to MIC/LINE INPUT jacks 1, 2.

#### MEMO

If you're sampling in stereo from an audio device, connect its left channel to MIC/LINE INPUT jack 1 and its right channel to MIC/LINE INPUT jack 2.

### 2. Press the [SAMPLING] button to make it light.

The SAMPLING STANDBY screen appears.

#### MEMO

If there is already a sample in the pad to which you're sampling, the message "Sample Already Exists. Overwrite?" appears. Press [E5] OK if you want to overwrite, or press [E6] CANCEL if you want to cancel.

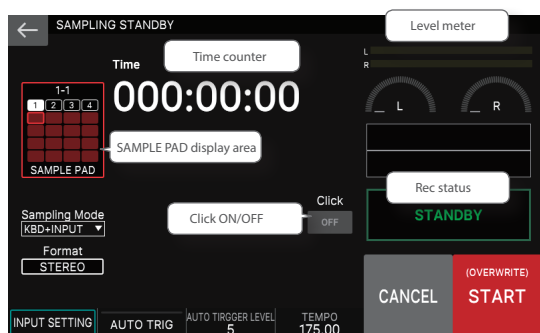

Menu	Explanation
[E1] INPUT SETTING	Makes input-related settings in the EFFECTS EDIT screen.
[E2] AUTO TRIG	Turns AUTO TRIGGER on/off.
AUTO TRIGGER LEVEL [E3] knob	Specifies the AUTO TRIGGER LEVEL.
TEMPO [E4] knob	Changes the click tempo.
[E5] CANCEL	Cancels the sampling standby state.
[E6] START	Starts sampling.
<Click>	Turns the click tone on/off.
<Sampling Mode>	Selects the sampling mode (input source).
<Format>	Selects the sampling format.

### 3. Note that the bank and number of the sample pad you're sampling are shown in the SAMPLE PAD display area.

In this example, the BANK 1-1 pad is selected.

### 4. If you want to change the bank and number of the sample pad, touch <SAMPLE PAD>.

In the SAMPLING DESTINATION (PAD) screen, select the bank and number of the pad to which you want to sample, and then select [E6] SELECT.

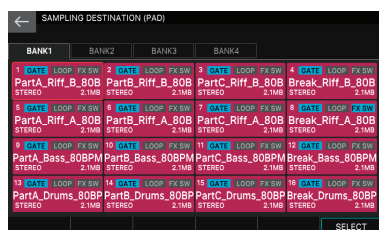

#### MEMO

If there is already a sample in the pad to which you are sampling, the message "Sample Already Exists. Overwrite?" appears. Press [E5] OK if you want to overwrite, or press [E6] CANCEL if you want to cancel.

### 5. Touch <Sampling Mode> and select the sampling mode.

Parameter	Explanation
KBD+INPUT	Samples the keyboard performance and the audio input from MIC/LINE INPUT jacks 1, 2 and the USB COMPUTER port.
KBD	Samples the keyboard performance.
INPUT	Samples the audio input from MIC/LINE INPUT jacks 1, 2 and the USB COMPUTER port.

## Specifying the Input Volume (Input Setting)

### Specifying the input volume of an audio device or mic

Here's how to specify the input volume of an audio device or mic connected to MIC/LINE INPUT jacks 1, 2.

### 1. In the SAMPLING STANDBY screen, select [E1] INPUT SETTING.

The EFFECTS EDIT screen's AUDIO IN tab appears.

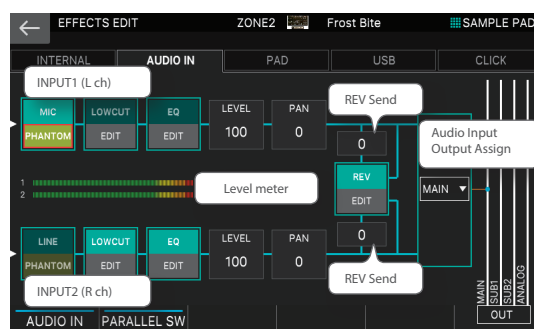

Menu	Explanation	
[E1] AUDIO IN	Turns on/off the input from MIC/LINE INPUT jacks 1, 2. If this is off, the signal is not input.	
[E2] PARALLEL SW	If this is on, you can make input settings individually for the INPUT 1 (L ch) side and the INPUT 2 (R ch) side. If this is off, only the INPUT 1 (L ch) side is shown, and the same settings are applied to both INPUT 1 and INPUT 2. Turn this off if you connect a stereo device.	
<LINE>/<MIC>	Specifies the input gain. Each time you touch this, it alternates between "LINE" and "MIC." Select "LINE" is a line-level audio device is connected, or select "MIC" is a mic is connected. This can be set individually for INPUT 1 and INPUT 2.	
<PHANTOM>	Turns on/off phantom power (DC 48 V, 10 mA Max). Turn phantom power on if you connect a condenser mic.	
<LOWCUT> (INPUT 1/2 independent)	Applies a low cut to the audio input. This cuts the unwanted low-frequency region.	Indicates the effect on/off status and shows the edit screen.
<EQ> (INPUT 1/2 independent)	Applies an equalizer to the audio input.	For details, refer to "Editing the sampling input effects" (p. 56) and "Parameter Guide" (PDF).
<REV>	Applies reverb to the audio input. This setting is common to INPUT 1 and INPUT 2.	
<LEVEL> (INPUT 1/2 independent)	Specifies the volume level after the sound passes through Low Cut and EQ. (Range: 0–127)	
<PAN> (INPUT 1/2 independent)	Specifies the pan after the sound passes through Low Cut and EQ. (Range: 63R–L64)	
<REV Send> (INPUT 1/2 independent)	Specifies the amount that is sent to reverb. (Range: 0–127)	
<Audio Input Output Assign>	Specifies the jack from which the audio input of INPUT 1 and INPUT 2 is output.	

## 2. As appropriate for the device that is connected, set the “AUDIO IN,” “PARALLEL SW,” “LINE”/“MIC,” and “PHANTOM” settings.

## 3. Adjust the input volume.

Adjust the volume as high as possible without allowing the level meter in the left of the screen to clip.

Connected device	Explanation
Audio device	Adjust using rear panel LEVEL knobs 1 and 2, and the controls of the audio device.
Microphone	Adjust using rear panel LEVEL knobs 1 and 2.



## 4. As necessary, make settings for effects such as Low Cut and EQ.

## 5. Touch <LEVEL>, and adjust the volume of the sound after it passes through Low Cut and EQ.

Some EQ settings might make the audio input too loud. Adjust the volume so that the level meter of the SAMPLING STANDBY screen does not clip.

## 6. Press the [EXIT] button to return to the SAMPLING STANDBY screen.

### Specifying the input volume of the USB COMPUTER port

Here’s how to specify the input volume of the USB COMPUTER port. Input effects such as Low Cut and EQ do not apply to the audio input from the USB COMPUTER port.

### 1. In the SAMPLING STANDBY screen, adjust the input volume.

Adjust the volume as high as possible without allowing the level meter in the right of the screen to clip.

Connected device	Explanation
Computer	Adjust using the settings of the computer and the USB Audio Input Level.

It’s a good idea to leave the USB Audio Input Level at 127 and adjust the level setting on your computer. Be sure that the USB Audio Input Switch is “ON.” For details on USB audio input settings, refer to “Adjusting the USB Audio Input” (p. 102).

### Specifying the input volume of the keyboard performance

Here’s how to specify the input volume of the keyboard performance. Input effects such as Low Cut and EQ do not apply to the audio input from the keyboard performance.

### 1. In the SAMPLING STANDBY screen, adjust the input volume.

Adjust the volume as high as possible without allowing the level meter in the right of the screen to clip.

Connected device	Explanation
Keyboard performance	Use the scene settings to adjust the volume.

It’s a good idea to adjust the input volume by editing the Scene Level and the zone level parameters.

## Sampling

When you are finished adjusting the input volume, make sampling settings in the SAMPLING STANDBY screen.

### 1. Make settings for sampling.

In the screen, touch parameters to turn them on/off or then use the [VALUE] dial to edit the setting.

Parameter	Value	Explanation
Format	MONO	Sample as one waveform. Choose this if you’re using one mic and are sampling in mono. If the input is stereo, the L and R sound is mixed and sampled.
	STEREO	Sample as two waveforms, L and R. Choose this if you’re sampling in stereo from an audio device, etc.
AUTO TRIGGER LEVEL	0–15	If Auto Trig is “ON,” sampling starts when the input signal level exceeds the value specified here.
AUTO TRIGGER	OFF, ON	If this is “ON,” sampling starts when the input signal level exceeds the value of the AUTO TRIGGER LEVEL setting. If this is “OFF,” sampling starts immediately when you touch <START>.

If you want to hear a click while you sample, touch <Click> to turn on the click tone. If you want to change the tempo of the click, use the [E4] knob to adjust the Tempo setting.

### 2. Produce sound on the device that’s connected to the FANTOM, and then touch <START> when you want to start sampling.

The indication “NOW SAMPLING” appears during sampling, and a time counter advances.

#### If you specified AUTO TRIGGER “OFF” in step 1

Sampling starts the moment that you touch <START>.

Produce sound on the device that’s connected to the FANTOM.

#### If you specified AUTO TRIGGER “ON” in step 1

Produce sound on the device that’s connected to the FANTOM. Sampling starts when the input signal exceeds the level specified by AUTO TRIGGER LEVEL.

### 3. Touch <STOP> at the moment that you want to stop sampling.

Sampling stops, and the sample is saved to the sampling-destination pad.

#### MEMO

- Samples are saved in sample memory inside the FANTOM.
- Samples are saved automatically. You don’t need to execute a specific operation to save them.

## Importing an Audio File

In addition to sampling on the FANTOM itself, audio files from your computer can be imported as samples via a USB flash drive.

### Audio files that can be imported

WAV/AIFF	Sampling frequency	44.1/48/96 kHz
	Bit rate	8/16/24 bit
MP3	Format	MPEG-1 audio layer 3
	Sampling frequency	44.1/48 kHz
	Bit rate	64/80/96/112/128/160/192/224/256/320 kbps, VBR (Variable Bit Rate)

### 1. In advance, put the audio files to be imported in the desired folder on your USB flash drive.

#### NOTE

- Use a USB flash drive that has been formatted by the FANTOM itself.
- The process might take some time depending on the size of the files being imported.

### 2. Hold down the [SHIFT] button and press the [SAMPLING] button.

The SAMPLE PAD screen appears.

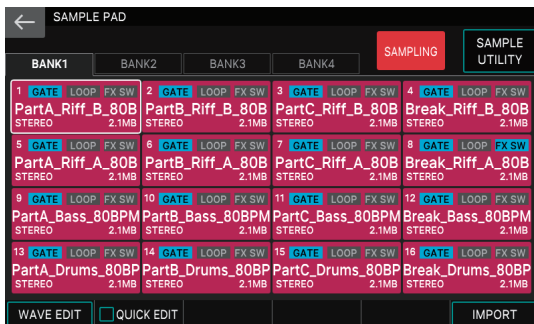

### 3. Select IMPORT [E6].

The PAD SAMPLE IMPORT screen appears.

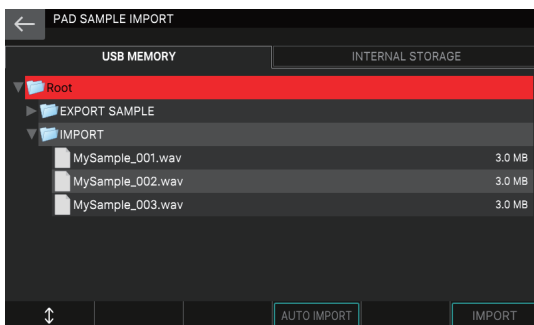

### 4. Select the file or folder that you want to import.

The selected file or folder is highlighted.

You can use the following controllers to select the file or folder.

Operation	Explanation
Touch a file name, folder name, or tab in the screen	Directly selects the file or folder that you touch. Switches tabs.
[E1] knob [▲] button, [▼] button	Selects a file or folder while scrolling up/down.
[ENTER] button	Expands the contents of a folder. Press again to collapse the expanded content.
[▶] button	Expands the contents of a folder to be visible.
[◀] button	Collapses the expanded content.
[EXIT] button	Returns to the previous screen.

### 5. Select the import method.

Menu	Explanation
[E4] AUTO IMPORT	The samples are automatically imported consecutively to pads that have not been assigned samples.
[E3] IMPORT	The samples are imported to the specified pad. If a sample has already been assigned to the pad, it is overwritten.

#### To execute AUTO IMPORT

### 1. To select the file(s) that you want to import, touch the file name.

By touching a file name while you hold down the [SHIFT] button, you can select multiple files simultaneously.

### 2. Select [E4] AUTO IMPORT.

A confirmation message appears.

### 3. Select [E5] OK.

To execute AUTO IMPORT

If you decide to cancel, choose [E6] CANCEL.

#### MEMO

If there are not enough empty pads for the import operation, the message "Not Found! Empty PAD was not found." appears. In advance, use the DELETE function to prepare a sufficient number of empty pads before you execute the import operation.

## To execute IMPORT

### 1. Touch a file name to select the file that you want to import.

To execute IMPORT, select only one file.

### 2. Select [E6] IMPORT.

The SAMPLE IMPORT (SELECT DESTINATION) screen appears.

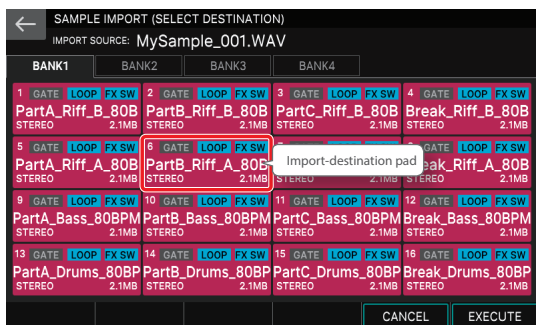

### 3. Touch an icon in the screen to select the import-destination bank and pad.

The icon of the selected pad is framed in red. In this example, the BANK 1-6 pad is selected.

### 4. Select [E6] EXECUTE.

A confirmation message appears.

### 5. Select [E5] OK.

IMPORT is executed.

If you decide to cancel, choose [E6] CANCEL.

#### MEMO

If there is a sample in the import-destination pad, the message "A Sample Already Exists. Overwrite?" appears. If you want to overwrite, select [E5] OK.

#### NOTE

Never turn off the power while import is in progress.

#### MEMO

In addition to importing audio files from your computer, you can import audio files from a folder such as "EXPORT SAMPLE." You can also switch the tab to "INTERNAL LIBRARY" and import audio files from the library.

# Editing a Sample

Here's how to edit a recorded sample. There are two types of editing: "Quick Edit" and "Wave Edit."

## Using Quick Edit

Quick Edit lets you make basic settings for each sample.

1. Hold down the [SHIFT] button and press the [SAMPLING] button.

The SAMPLE PAD screen appears.

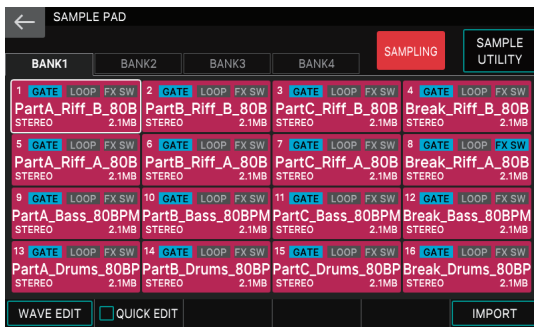

2. Select [E2] QUICK EDIT.

The SAMPLE PAD (QUICK EDIT) screen appears.

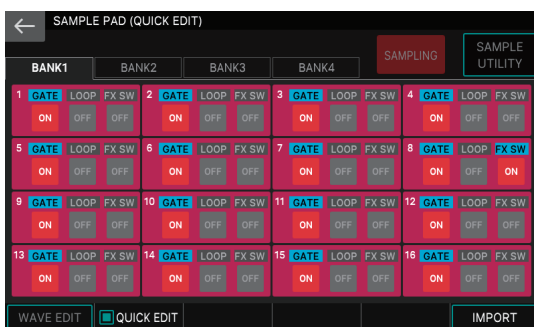

3. Touch a <BANK> tab to select a bank.

4. Touch the parameters of each pad to edit their values.

Parameter	Value	Explanation
GATE	OFF, ON	Specifies whether the sample stops playing when you release the pad (ON) or continues playing even after you release the pad (OFF). If this is ON, you can use the [HOLD] button to hold the sound.
LOOP	OFF, ON	Specifies whether the sample plays as a loop (ON) or does not play as a loop (OFF).
FX SW	OFF, ON	Specifies whether effects are applied to the sample (ON) or not applied (OFF). <b>MEMO</b> Master FX can be applied to the sample.

5. When you have finished editing, select [E2] QUICK EDIT once again to return to the SAMPLE PAD screen.

## Using Wave Edit

Wave Edit lets you make detailed settings for each sample.

1. Hold down the [SHIFT] button and press the [SAMPLING] button.

The SAMPLE PAD screen appears.

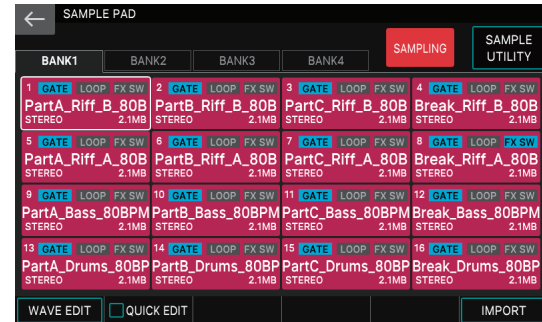

2. Touch a <BANK> tab to select a bank.

3. Touch the desired pad to select its sample.

4. Select [E1] WAVE EDIT.

The WAVE EDIT screen appears.

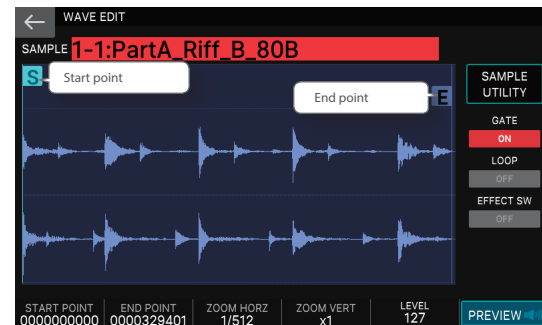

Menu	Explanation
SAMPLE	Selects another sample.
START POINT [E1] knob	Changes the start point.
END POINT [E2] knob	Changes the end point.
ZOOM HORZ [E3] knob	Changes the display magnification of the horizontal axis (the waveform's time). (1/65536-1/1)
ZOOM VERT [E4] knob	Changes the display magnification of the vertical axis (the waveform's amplitude) (x1-x128)
LEVEL [E5] knob	Changes the level.
[E6] PREVIEW	Auditions the sample while you continue pressing the knob.
<SAMPLE UTILITY>	Accesses the SAMPLE UTILITY window (p. 71).

**MEMO**

As an alternative to using the [E1] [E2] knobs, you can also change the start point and end point by directly dragging the START POINT icon and END POINT icon in the screen to left or right. You can also scroll the waveform display by dragging left or right on a location other than an icon.

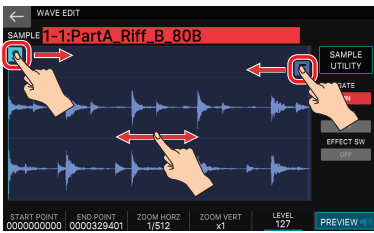

**5. Edit the desired parameter.**

Parameter	Value	Explanation
START POINT	000000000-	This is the playback start point. Adjust this to skip any unwanted portion of the waveform at the beginning of the sample, so that the desired sound plays immediately.
END POINT	000001000-	This is the playback end point. Adjust this to omit any unwanted portion of the waveform at the end of the sample, so that it does not play. * The distance between the start point and the end point cannot be 999 or less.
LEVEL	0-127	Adjusts the volume of the sample.
GATE	OFF, ON	Specifies whether the sample will stop playing when you release the pad (ON) or will continue playing even after you release the pad (OFF). If this is ON, you can use the [HOLD] button to hold the playback.
LOOP	OFF, ON	Specifies whether the sample will (ON) or will not (OFF) play as a loop.
FX SW	OFF, ON	Specifies whether the effect will (ON) or will not (OFF) be applied to the sample. <b>MEMO</b> You can apply Master FX to the sample.

**6. When you have finished editing, press the [EXIT] button to return to the SAMPLE PAD screen.**

**MEMO**

The sample is saved automatically.

**Using the Sample Utility Functions**

In addition to “Quick Edit” and “Wave Edit,” you can use the Sample Utility functions to do various things such as rename a sample or export it as a WAV file. You can execute the Sample Utility functions from the SAMPLE PAD screen or the WAVE EDIT screen. The menus differ for each screen.

**MEMO**

The sample is automatically saved after each function is executed.

**Using Sample Utility functions in the SAMPLE PAD screen**

The operation applies to the sample that is selected by the pads. The operations DELETE ALL and EXPORT ALL (WAV) apply to all samples.

**Using Sample Utility functions in the WAVE EDIT screen**

The operation applies to the sample that is selected in the WAVE EDIT screen.

**Renaming the Sample (RENAME)**

SAMPLE PAD WAVE EDIT

Here’s how to change the name of the sample.

- In the SAMPLE PAD screen, touch <SAMPLE UTILITY>. Alternatively, in the WAVE EDIT screen, touch <SAMPLE UTILITY>.**  
The SAMPLE UTILITY window appears.
- Touch <RENAME>.**  
The RENAME screen appears.
- Edit the sample name as described in the explanation for the RENAME screen (p. 13).**
- Select [E6] OK.**  
If you decide to cancel, choose [E5] CANCEL.

**Cutting Unwanted Regions from the Sample (TRUNCATE)**

WAVE EDIT

Here’s how you can cut unwanted regions from the beginning and end of the sample by specifying the desired portion (start point and end point).

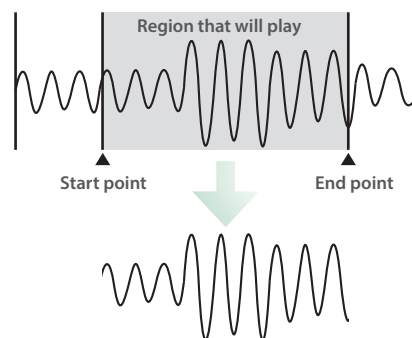

1. In the WAVE EDIT screen, specify the start point and end point.

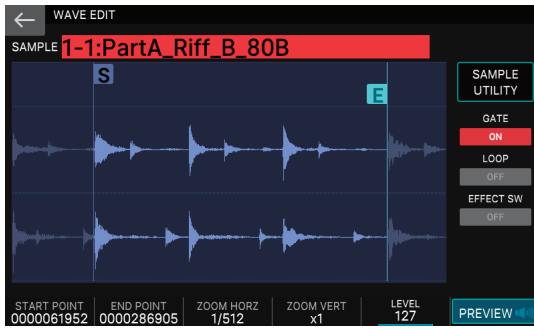

2. Touch <SAMPLE UTILITY>.

The SAMPLE UTILITY window appears.

3. Select <TRUNCATE>.

A confirmation message appears.

If you decide to cancel, choose [E6] CANCEL.

4. Select [E5] OK.

The Truncate operation is executed.

## Deleting a Sample (DELETE)

SAMPLE PAD WAVE EDIT

Here's how to delete a sample.

1. In the SAMPLE PAD screen, touch <SAMPLE UTILITY>. Alternatively, in the WAVE EDIT screen, touch <SAMPLE UTILITY>.

The SAMPLE UTILITY window appears.

2. Touch <DELETE>.

A confirmation message appears.

If you decide to cancel, select [E6] CANCEL.

3. Select [E5] OK.

The sample is deleted.

## Deleting All Samples (DELETE ALL)

SAMPLE PAD

This deletes all samples of BANK 1–4.

1. In the SAMPLE PAD screen, touch <SAMPLE UTILITY>.

The SAMPLE UTILITY window appears.

2. Touch <DELETE ALL>.

A confirmation message appears.

If you decide to cancel, select [E6] CANCEL.

3. Select [E5] OK.

All samples are deleted.

## Exporting the Sample in WAV Format (EXPORT WAV)

SAMPLE PAD WAVE EDIT

Here's how to export the sample in WAV format.

1. In the SAMPLE PAD screen, touch <SAMPLE UTILITY>. Alternatively, in the WAVE EDIT screen, touch <SAMPLE UTILITY>.

The SAMPLE UTILITY window appears.

2. Select <EXPORT (WAV)>.

A confirmation message appears.

If you decide to cancel, choose [E6] CANCEL.

3. Select [E5] OK.

The sample is exported.

4. Select [E6] CLOSE to close the screen.

The exported WAV file is saved in the "EXPORT SAMPLE" folder of the USB flash drive.

- \* If the export-destination contains a file of the same name, the message "Duplicate File Name! Overwrite it?" appears. Select [E5] OK to overwrite, or select [E6] CANCEL to cancel.

### NOTE

Never turn off the power while data is being exported.

### MEMO

- By exporting after executing Truncate in the WAVE EDIT screen, you can export the portion of the waveform that is between the start point and the end point.
- The exported WAV file is 48 kHz 16-bit format.

## Exporting All Samples in WAV Format (EXPORT ALL WAV)

SAMPLE PAD

Here's how all samples of BANK 1–4 can be exported in WAV format.

1. In the SAMPLE PAD screen, touch <SAMPLE UTILITY>.

The SAMPLE UTILITY window appears.

2. Select <EXPORT ALL (WAV)>.

A confirmation message appears.

If you decide to cancel, select [E6] CANCEL.

3. Select [E5] OK.

All samples are exported.

4. Select [E6] CLOSE to close the screen.

The exported WAV files are saved in the "EXPORT SAMPLE" folder of the USB flash drive.

- \* If the export-destination contains a file of the same name, the message "Duplicate File Name! Overwrite it?" appears. Select [E5] OK to overwrite, or select [E6] CANCEL to cancel.

### NOTE

Never turn off the power while data is being exported.

### MEMO

The exported WAV files are in 48 kHz 16-bit format.



# 06: Pads

## Contents

---

<b>Assigning Convenient Functions to the Pads</b> (PAD MODE) .....	<b>74</b>
◇ <b>Basic Pad Mode Operation</b> .....	<b>74</b>
◇ <b>Playing Samples</b> (Sample Pad) .....	<b>74</b>
◇ <b>Playing Tones</b> (Note Pad) .....	<b>74</b>
◇ <b>Selecting Partial</b> s and <b>Turning Them On/Off</b> (Partial Sw/Sel) .....	<b>75</b>
◇ <b>Controlling a DAW</b> (DAW Control) .....	<b>75</b>
◇ <b>Switching Zone Mute</b> (Zone Mute) .....	<b>76</b>
◇ <b>Switching Zone Solo</b> (Zone Solo) .....	<b>76</b>
◇ <b>Turning the Keyboard Switch Group On/Off</b> (Kbd Sw Group) .....	<b>76</b>
◇ <b>Playing Rhythm Patterns</b> (Rhythm Pattern) .....	<b>77</b>
◇ <b>Using the System Settings</b> (System) .....	<b>77</b>

# Assigning Convenient Functions to the Pads (PAD MODE)

## Basic Pad Mode Operation

You can assign various useful functions to the 16 pads of the FANTOM, such as playing samples or muting zones. These functions are called pad modes.

### MEMO

Pad mode settings are saved in the scene.

### 1. Press the [PAD MODE] button.



The PAD MODE screen appears.

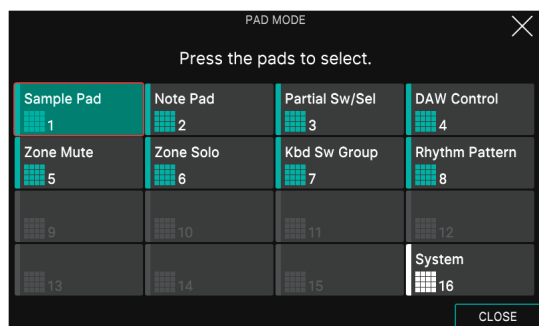

### 2. Press a pad [1]–[8] or [16] to select a function.

The pad mode changes, and you return to the previous screen.

You can also switch pad modes by touching an icon in the screen.

Pad	Function	Explanation
[1]	Sample Pad	The pads play samples.
[2]	Note Pad	The pads play tones.
[3]	Partial Sw/Sel	The pads select partials and turn them on/off.
[4]	DAW Control	The pads control your DAW software.
[5]	Zone Mute	The pads turn zone mute on/off.
[6]	Zone Solo	The pads turn zone solo on/off.
[7]	Kbd Sw Group	The pads turn the keyboard switch group on/off.
[8]	Rhythm Pattern	The pads play rhythm patterns.
[16]	System	The pads use the Pad Mode system settings.

### MEMO

After selecting a pad mode, you can hold down the [SHIFT] button and press the [PAD MODE] button to access the edit screen for the selected function.

## Playing Samples (Sample Pad)

The pads play samples.

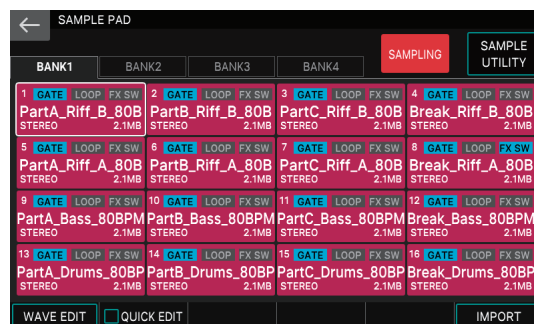

### MEMO

For details on using the sample pads, refer to "Pressing the Pads to Play Samples" (p. 64).

## Playing Tones (Note Pad)

In the same way as using the keyboard to play sounds, you can play tones by pressing the pads. Since you can specify the zone, note number, and velocity for each pad, you can (for example) use the keyboard to play the tone of zone 1 while using the pads to play the drum kit tone of zone 10.

### MEMO

Settings for each pad are saved as system settings. You can't make pad settings independently for each scene.

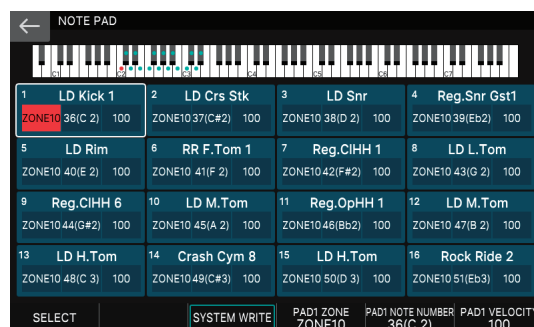

Pressing a pad will play a tone according to the settings of each pad.

Menu	Explanation
[E1] knob	Selects a pad.
[E3] SYSTEM WRITE	Saves the edited settings to the system.
[E4] knob	Selects the zone played by the selected pad.
[E5] knob	Selects the note number played by the selected pad. The selected note is indicated by a ● above the keyboard in the screen.
[E6] knob	Specifies the velocity played by the selected pad.

## Specifying the tone played by each pad

### 1. In the NOTE PAD screen, press a pad to select the pad that you want to edit.

You can also select a pad by using the [E1] knob or by directly touching an icon in the screen.

### 2. Move the cursor to the parameter that you want to edit, and edit the value.

You can also use the [E4]–[E6] knobs to directly edit the settings.

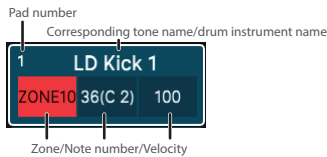

### 3. Repeat steps 1–2 to make settings for other pads as necessary.

### 4. To save the settings, choose SYSTEM WRITE [E3] to save them to the system.

**MEMO**

The parameters that you edit here are the same as the system parameters “Pad 1–16 Zone,” “Pad 1–16 Note Number,” and “Pad 1–16 Velocity” that you can edit in SYSTEM/NOTE PAD. They work in the same way when you edit them in the SYSTEM screen.

## Selecting Partials and Turning Them On/Off (Partial Sw/Sel)

You can use the pads to select and turn on/off the partials that you’re editing.

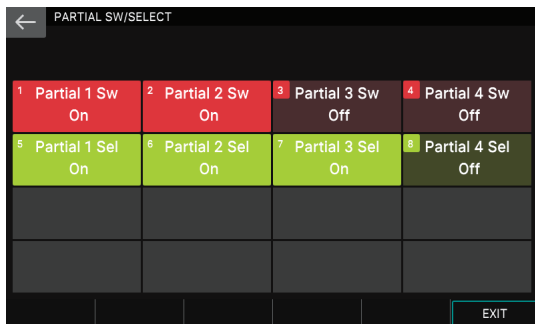

Pad	Explanation	Pad	Explanation
[1]	Select partial 1	[5]	Turn partial 1 on/off
[2]	Select partial 2	[6]	Turn partial 2 on/off
[3]	Select partial 3	[7]	Turn partial 3 on/off
[4]	Select partial 4	[8]	Turn partial 4 on/off

**MEMO**

- For a drum kit tone, you can select and turn on/off the wave of the selected key.
- For a V-Piano tone, this function has no effect.

## Controlling a DAW (DAW Control)

You can use the pads to control supported DAW software (Logic Pro X/MainStage).

**NOTE**

- Use this function when you want to use the “DAW CTRL function” to control Logic Pro X/MainStage on a Mac connected via USB.
- In order to connect the FANTOM with a Mac, you’ll need to install a USB driver. For details on installing the USB driver, refer to “Connecting to Your Computer” (p. 102).
- In order to use the DAW CTRL function, you’ll need to install the dedicated “Logic/MainStage plug-in” in addition to the USB driver. For details on using the DAW CTRL function and how to install the plug-in, refer to “Logic/MainStage Plug-In Usage Guide” (PDF).

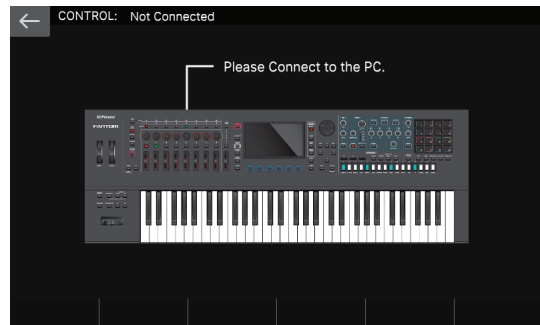

### Controlling Logic Pro X

Pad	Function	Explanation
[1]–[4]	Recall Screen Set 1–4	Recall screen sets 1–4.
[5]	ZOOM Horizontal IN	Zooms-in horizontally.
[6]	ZOOM Horizontal OUT	Zooms-out horizontally.
[7]	ZOOM Vertical IN	Zooms-in vertically.
[8]	ZOOM Vertical OUT	Zooms-out vertically.
[9]	Open Marker List / Close Window	Opens/closes the marker list.
[13]	Go to Next Marker	Moves to the next marker.
[14]	Go to Previous Marker	Moves to the previous marker.
[15]	Song Position by measure	Advances the locate position by one measure.
[16]	Play or Stop	While playing, operates as the stop button. While stopped, operates as the play button.

### Controlling MainStage

Pad	Function	Explanation
[1]	Next Set	Recalls the next set.
[2]	Previous Set	Recalls the previous set.
[3]	Next Patch	Recalls the next patch.
[4]	Previous Patch	Recalls the previous patch.
[13]	MIDI PC INC	Sends a Program Change message. The value sent is incremented by one each time you press the pad.
[14]	MIDI PC DEC	Sends a Program Change message. The value sent is decremented by one each time you press the pad.

## Switching Zone Mute (Zone Mute)

You can use the pads to mute (silence) the Zones (1–16). Pressing a pad switches the mute status of each zone. The pad is muted in the “On” state.

**MEMO**

- You can mute multiple zones simultaneously.
- The pad number corresponds to the zone number.
- This is the same function as “mute” in the MIXER screen.

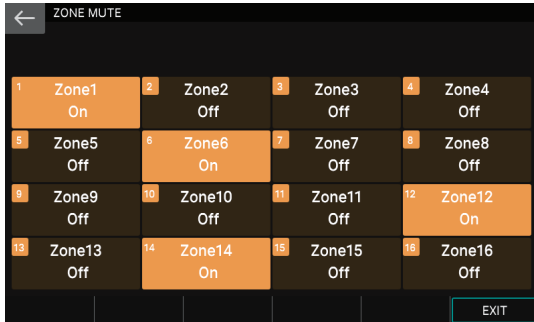

## Switching Zone Solo (Zone Solo)

You can use the pads to solo a zone (so that only the selected zone is heard).

The zone that you select by pressing the pad is soloed. Press a soloed pad once again to defeat solo.

**MEMO**

- You can't solo multiple zones.
- The pad number corresponds to the zone number.
- This is the same function as “solo” in the MIXER screen.

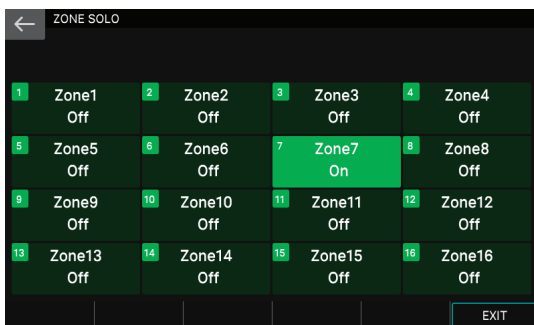

## Turning the Keyboard Switch Group On/Off (Kbd Sw Group)

You can use the pads to switch between pre-assigned keyboard switch groups.

**MEMO**

Kbd Sw Group (keyboard switch group) lets you handle a combination of the on/off status for each zone's ZONE INT/EXT button as one of 16 keyboard switch groups. By switching groups, you can instantly switch between different sounds played from the keyboard using multiple zones, while leaving the scene itself unchanged.

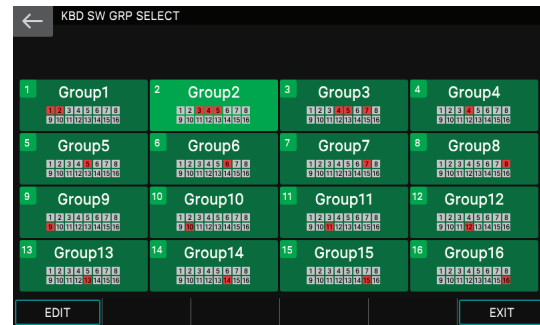

Press a pad to select a group. In the screen of settings, each group's icon shows the on/off status of each zone.

### Editing the status of each group

For each of the 16 keyboard switch groups, you can individually edit the combination of ZONE INT/EXT button on/off states.

1. In the KBD SW GRP SELECT screen, select the group that you want to edit.
2. Select [E1] EDIT.

The [BANK] is lit, and the KBD SW GRP EDIT screen appears.

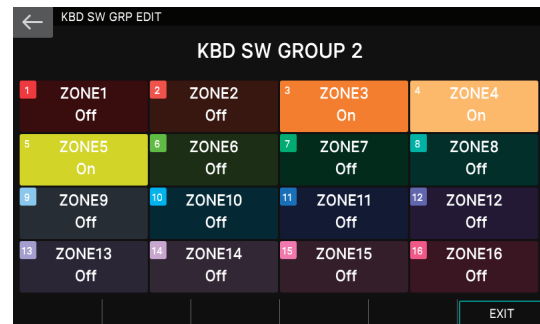

In this example, we are editing the state of each zone for GROUP 2.

3. To turn each zone's ZONE INT/EXT button on/off, touch an icon in the screen or press a pad.
4. When you have finished making settings, select [E6] EXIT to return to the KBD SW GRP SELECT screen.
5. If you want to make settings for another group, repeat steps 1–4.

**MEMO**

- Even when a screen other than the KBD SW GRP EDIT screen or the KBD SW GRP SELECT screen is shown, pressing the [BANK] button to make it light will make the pads illuminate to indicate the setting of each zone in the currently selected keyboard switch group. You can press the pads to change their status. Pad numbers correspond to zone numbers.
- Keyboard switch group settings are saved in the scene. If you want to save the settings, save the scene (p. 44).

## Playing Rhythm Patterns (Rhythm Pattern)

You can use the pads to play rhythm patterns. The operation is the same as when you touch the <Intro>–<Ending> icons in the RHYTHM PATTERN screen.

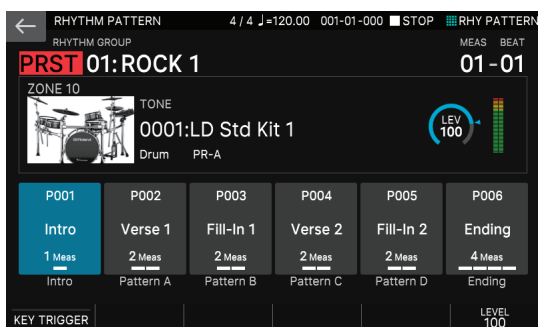

Pad	Explanation
[1]	Selects the Intro rhythm pattern.
[2]	Selects the Pattern A rhythm pattern.
[3]	Selects the Pattern B rhythm pattern.
[4]	Selects the Pattern C rhythm pattern.
[5]	Selects the Pattern D rhythm pattern.
[6]	Selects the Ending rhythm pattern.

## Using the System Settings (System)

The pads operate according to the setting of the system parameter “Pad Mode” (p. 112). The pad mode setting of each scene is ignored. This is convenient when you want to use the same pad mode functions in any scene.

## Memo

# 07: Sequencer

## Contents

<b>How the Sequencer Is Structured</b> .....	<b>80</b>
◇ <b>Pattern</b> .....	<b>80</b>
◇ <b>Group</b> .....	<b>80</b>
◇ <b>Song</b> .....	<b>80</b>

<b>Playing the Sequencer</b> .....	<b>81</b>
◇ <b>Playing Pattern</b> .....	<b>81</b>
Making Loop Settings (LOOP) .....	<b>82</b>
Setting the Tempo .....	<b>82</b>
Muting a Track (MUTE) .....	<b>83</b>
Soloing a Track (SOLO) .....	<b>83</b>
◇ <b>Playing Group</b> .....	<b>84</b>
◇ <b>Playing Song</b> .....	<b>84</b>
Showing the Timeline as Measures .....	<b>84</b>

<b>Song Production Workflow</b> .....	<b>85</b>
---------------------------------------	-----------

<b>Recording a Pattern</b> .....	<b>86</b>
◇ <b>Ways to Record a Pattern</b> .....	<b>86</b>
◇ <b>Preparing for Recording</b> .....	<b>86</b>
◇ <b>Realtime Recording</b> (Real Time REC) .....	<b>86</b>
Removing Unwanted Data During Recording (Realtime Erase) .....	<b>87</b>
◇ <b>Step Recording</b> (Step REC) .....	<b>88</b>
◇ <b>TR-REC</b> .....	<b>89</b>
◇ <b>Editing a Pattern</b> .....	<b>91</b>
Convenient Functions (Pattern Utility) .....	<b>91</b>
Applying Various Edits (MODIFY) .....	<b>92</b>
◇ <b>Importing SMF as a Pattern</b> (IMPORT) .....	<b>94</b>
◇ <b>Exporting a Pattern as SMF</b> (EXPORT) .....	<b>95</b>
◇ <b>Saving a Pattern</b> .....	<b>95</b>

<b>How to Create a Group</b> .....	<b>96</b>
◇ <b>Creating a Group</b> .....	<b>96</b>
Naming a Group (RENAME) .....	<b>96</b>
◇ <b>Editing a Group</b> .....	<b>97</b>
Basic Operation in the GROUP Screen .....	<b>97</b>
Specifying the Loop Settings (Length) .....	<b>97</b>
Naming a Group (RENAME) .....	<b>97</b>
Initializing a Group (INITIALIZE) .....	<b>97</b>
◇ <b>Exporting a Group as SMF</b> (EXPORT) .....	<b>97</b>
◇ <b>Saving a Group</b> .....	<b>97</b>

<b>How to Create a Song</b> .....	<b>98</b>
◇ <b>Creating a Song</b> .....	<b>98</b>
◇ <b>Editing a Song</b> .....	<b>98</b>
Basic Operation in the SONG Screen .....	<b>98</b>
Skipping a Specific Group (SKIP) .....	<b>98</b>
Editing the Song's Structure (SONG EDIT) .....	<b>99</b>
◇ <b>Adjusting the Pan and Volume Balance</b> .....	<b>100</b>
◇ <b>Exporting a Song as SMF</b> (EXPORT) .....	<b>100</b>
◇ <b>Saving a Song</b> .....	<b>100</b>

# How the Sequencer Is Structured

## Pattern

This unit's sequencer lets you record and play back using 16 tracks which correspond to the zones. Each track can have up to eight patterns, and these variations are called patterns. For each track, you can switch the variation during playback. Each pattern can be up to 32 measures long, and will play as a loop of the length that is specified for each pattern.

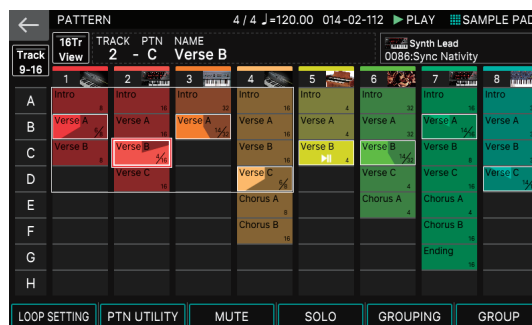
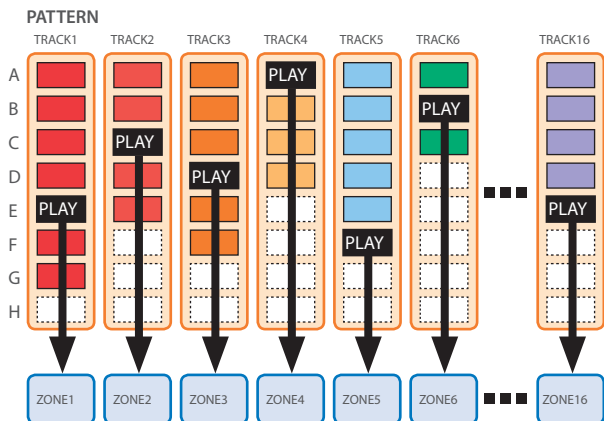

## Group

The combination of patterns created for each track is called a group. You can create groups such as "Intro," "Verse," or "Fill" corresponding to each section of your song.

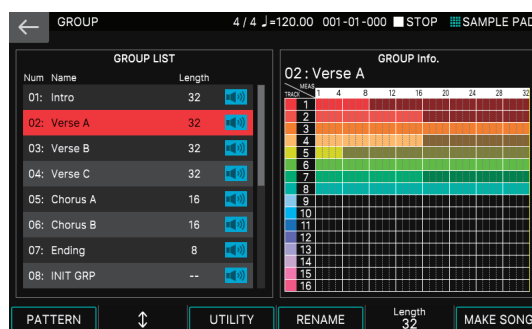
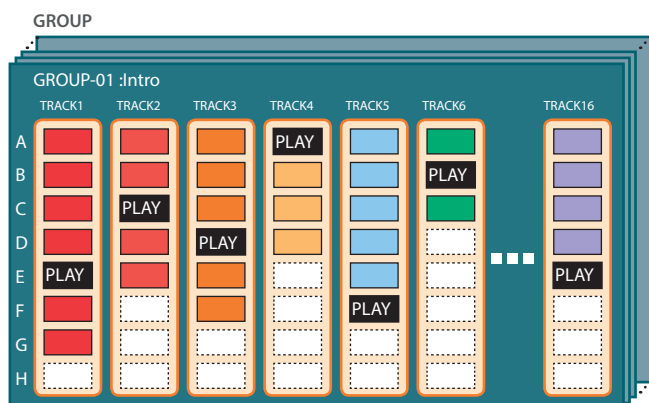

## Song

The groups you create can be arranged into an order that's called a song. You can specify looping (LOOP) for individual groups and for the entire song.

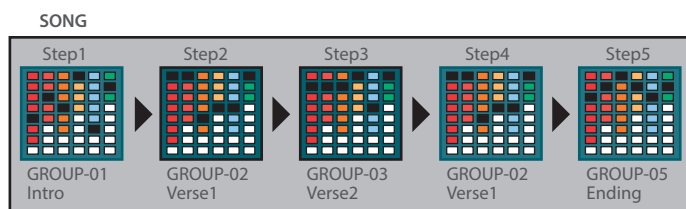

### MEMO

Patterns, groups, and songs are all saved for each scene.



# Playing the Sequencer

## Playing Pattern

### 1. Select a scene.

Select a scene in which patterns have been created.

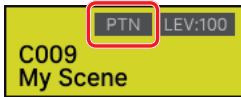

Scenes in which patterns have been created have a "PTN" indication as shown in the illustration.

### 2. Press the [PATTERN] button.

The PATTERN screen appears.



## About the PATTERN screen

### 8Tr View

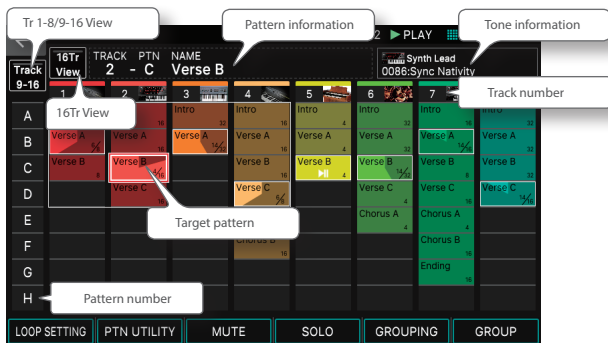

### 16Tr View

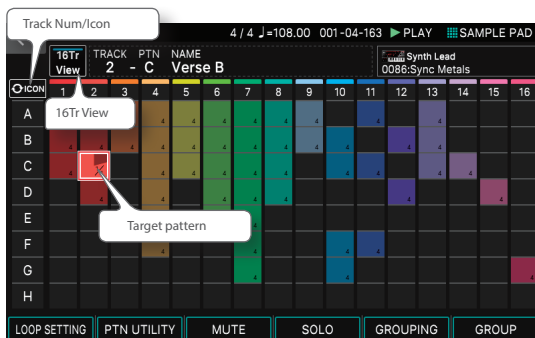

A box (pattern box) in which a phrase is recorded is shown in color.

In the PATTERN screen you can use the following functions.

Menu	Explanation
[E1] LOOP SETTING	Accesses the LOOP SETTING screen.
[E2] PTN UTILITY	Accesses the PTN UTILITY screen.
[E3] MUTE	Accesses the MUTE screen.
[E4] SOLO	Accesses the SOLO screen.
[E5] GROUPING	Accesses the GROUPING screen.
[E6] GROUP	Accesses the GROUP screen.
<Tr 1-8/9-16 View>	Switches the tracks that are shown (tracks 1-8/9-16).
<16Tr View>	If this is on, all 16 tracks are shown in a single screen.
<TRACK NUM/ICON>	Switches the information that is displayed (track number or instrument icon) when the 16Tr View is shown.

### Play-standby

If you long-touch an already-recorded pattern box in a track, the pattern box changes to be highlighted. This indicates play-standby, meaning that it will play when you press the [▶ PLAY] button. Only one pattern box in each track can be set to play-standby. The pattern that is in this play-standby mode is called the current pattern.

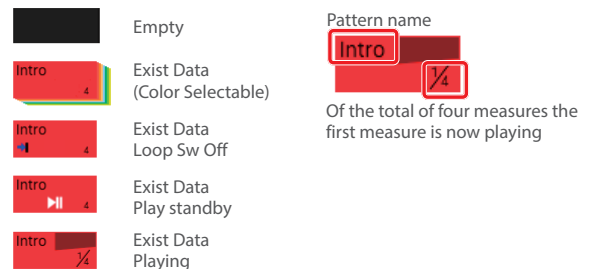

### 3. Press the [▶ PLAY] button.

Each track's pattern that's in play-standby mode will play.

- If you touch a pattern box that's not playing, the pattern you touch is played.
- By directly touching a colored pattern box in the screen, you can switch patterns for each track.

### 4. If you press the [■ STOP] button, pattern playback stops for all tracks.

- If you touch a pattern box that's playing, only the pattern that you touched stops.
- If you switch or stop/start patterns while another pattern is playing, the change automatically happens at measure boundaries of the other playing pattern.

## Making Loop Settings (LOOP)

For each pattern, you can make detailed settings to specify whether and how it loops.

**MEMO**

The loop parameter settings of each pattern are saved in the scene.

### 1. In the PATTERN screen, select the pattern box whose settings you want to edit.

The selected pattern box has a red border. To select a pattern, you can use the cursor [**▲**] [**▼**] [**◀**] [**▶**] buttons, or directly long-touch the pattern box to put it in play-standby mode.

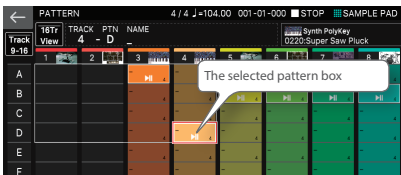

### 2. Select [E1] LOOP SETTING.

The LOOP SETTING screen appears.

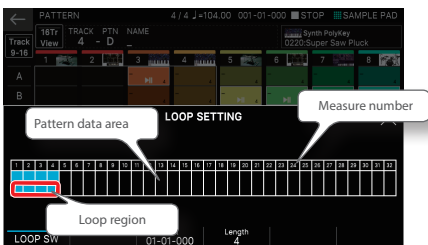

- In the pattern data area, the region filled in solid blue is the loop region.
- In the pattern data area, the presence or absence of note data is shown as a simple piano-roll display.

### 3. Edit the loop parameters.

Parameter	Value	Explanation
[E1] LOOP SW	OFF, ON	Turns looping on/off. A pattern for which this "OFF" will play once during playback, and then automatically stop (one-shot playback).
Start [E3] knob	01-01-000-32-01-000	Specifies the play start point. You can set this value in units of a beat. The loop region starts at the point specified by Start and extends for the length specified by Length.
Length [E4] knob	1-32	Specifies the length of the loop. You can specify a value that is longer than the length of the original pattern. The added portion will be blank playback.

### 4. When you have finished editing, press the [EXIT] button to return to the PATTERN screen.

## Setting the Tempo

You can set the tempo of the sequencer.

**MEMO**

- The tempo that you specify here is in common with the arpeggio tempo (p. 30) and the rhythm pattern tempo (p. 35).
- The modified tempo also applies to the group and song playback.
- The tempo setting is saved in the scene.

### 1. Press the [TEMPO] button.

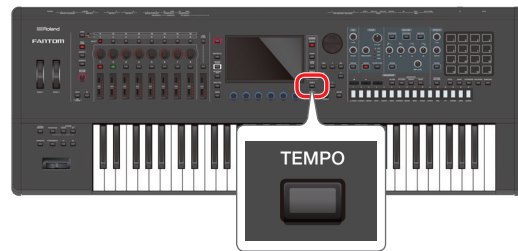

The TEMPO screen appears.



Menu	Explanation
[E5] CLICK	If this is on, a click tone is sounded at the tempo.
[E6] CLOSE	Closes the screen.

### 2. Use the [VALUE] dial or the [INC] [DEC] buttons to set the tempo.

By holding down the [SHIFT] button while doing this, you can edit the two digits below the decimal point.

**MEMO**

- You can set the tempo by pressing the [TEMPO] button at the desired interval ("tap tempo"). Press the button at least three times, at quarter-note intervals of the desired tempo.

## Muting a Track (MUTE)

For each track, you can mute the pattern playback. You can also mute during playback.

**MEMO**

The mute status of each track is saved in the scene.

### 1. In the PATTERN screen, select [E3] MUTE.

The MUTE SELECT screen appears.

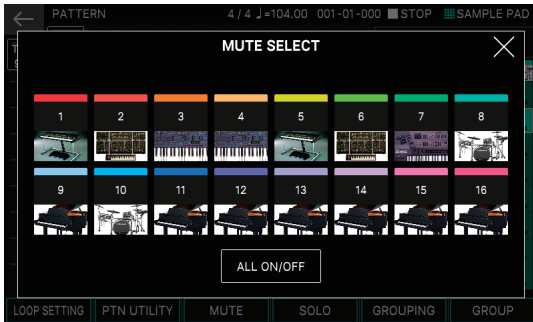

### 2. Touch the track that you want to mute.

The icon of the track you touch changes color, and the track playback is muted.

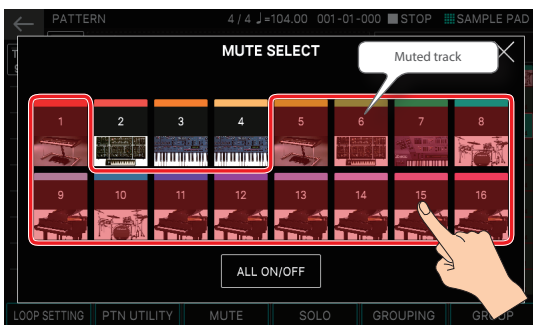

By touching "ALL ON/OFF" in the screen, you can mute/unmute all tracks in a single operation.

### 3. When you are finished making settings, press the [EXIT] button to return to the PATTERN screen.

Even in the PATTERN screen, muted tracks can be clearly distinguished because of their changed color. Even if you switch a muted track between variations A–H, the track's mute status is maintained.

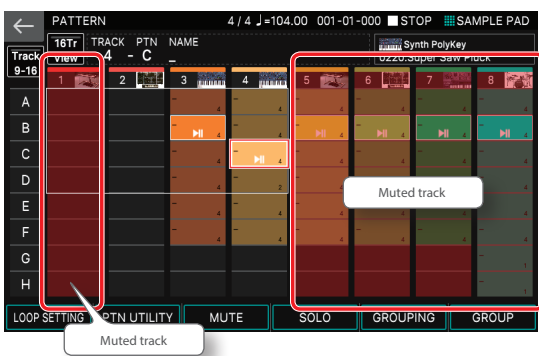

## Soloing a Track (SOLO)

You can solo the playback of the selected track. You can also solo during playback.

**MEMO**

The solo status of each track is saved in the scene.

### 1. In the PATTERN screen, select [E4] SOLO.

The SOLO SELECT screen appears.

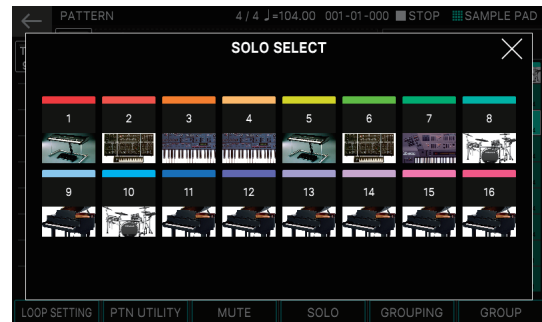

### 2. Touch the track that you want to solo.

The icons of all tracks other than the track you touch change color, and the track plays solo.

You can also solo multiple tracks.

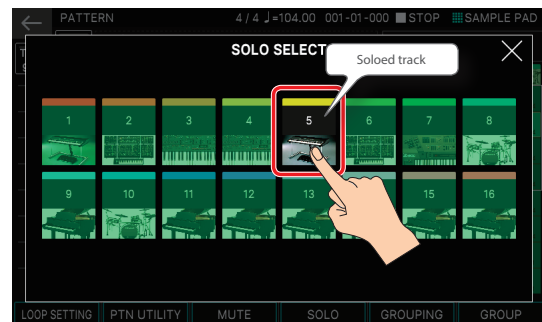

If you once again touch the icon of a track that's being soloed, solo is defeated.

If you're soloing multiple tracks, solo is defeated consecutively.

### 3. When you are finished making settings, press the [EXIT] button to return to the PATTERN screen.

Even in the pattern screen, tracks that are not being played can be clearly distinguished because of their changed color, as when they are muted. Even if you switch a soloed track between variations A–H, the track's soloed status is maintained.

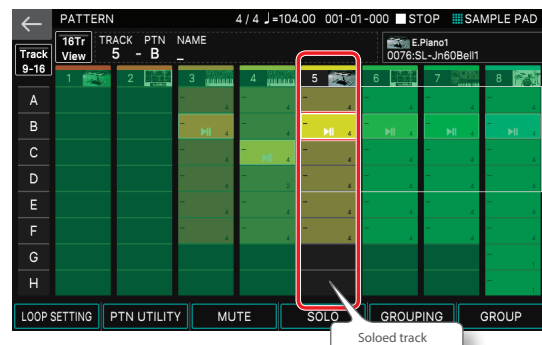

**NOTE**

The "solo" and "mute" that can be specified in the PATTERN screen refer to "soloing or muting a track." Be aware that these are different functions than the "soloing or muting a zone" that can be specified in the MIXER screen, and that they operate independently. Zones that are muted in the MIXER screen do not sound even if you play the keyboard, but muting a zone in the PATTERN screen does not affect how it can be played by the keyboard.

## Playing Group

### 1. Select a scene.

Select a scene in which a song is created.



Scenes in which a song is created have a "SONG" indication as shown in the illustration.

### 2. Press the [GROUP] button.

The GROUP screen appears.

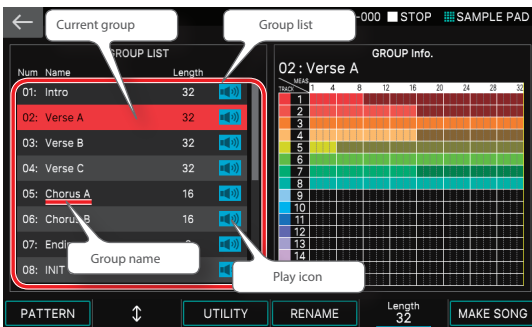

- The left side of the screen is called the GROUP LIST area, and shows the group names in numerical order.
- The currently selected group (current group) is indicated by the cursor.

### 3. Press the [PLAY] button.

The current group plays.

You can also play a group by touching its play icon in the group list.

During playback, the GROUP PREVIEW screen is shown. Like the PTN screen, the GROUP PREVIEW screen shows each track's current part at a glance.

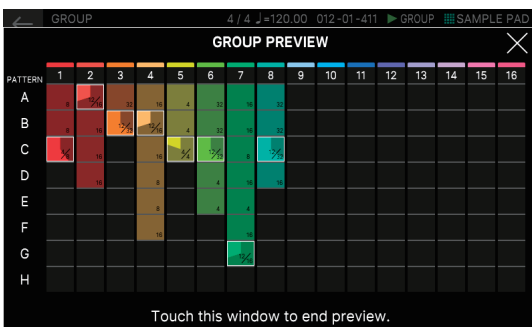

### 4. To stop playback, press the [STOP] button.

You can also stop by touching the GROUP PREVIEW screen.

### 5. To select a different group, directly touch its group name to select it.

You can also use the [E2] knob to make a selection.

## Playing Song

### 1. Select a scene.

Select a scene in which a song is created.



Scenes in which a song is created have a "SONG" indication as shown in the illustration.

### 2. Press the [SONG] button.

The SONG screen appears.



A succession of boxes called group boxes is shown, each with a number indicating the playback order.

Within each group box is shown information such as the group number, group name, and the number of times it will loop. Nothing is shown in an empty group box.

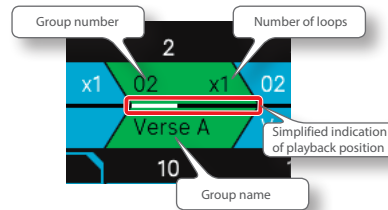

### 3. Press the [▶ PLAY] button.

The song plays, and the groups play in numerical order.

The currently-playing group (the current group) is indicated by a green group box.

### 4. Press the [■ STOP] button to stop playback.

## Showing the Timeline as Measures

Numbers that indicate the playback order are shown above the group box in the screen, but you can switch these to indications of the measure. Viewing the timeline in terms of measures can make the structure of the song easier to understand.

### 1. In the SONG screen, select [E5] MEAS.

The indication above the boxes changes to a measure indication.

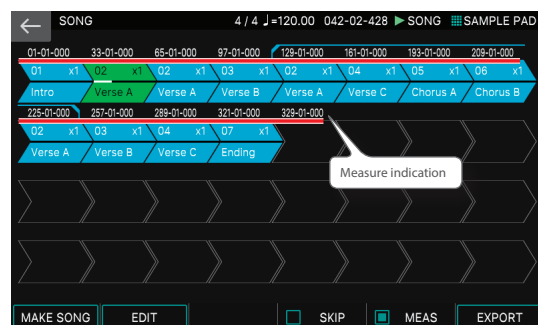

# Song Production Workflow

To create a song on the FANTOM, begin by creating patterns which are the smallest structural unit of the song, then combine multiple patterns to create groups, and finally place multiple groups in a desired order to complete a song.

- This simple flow lets you reach the desired result without getting lost.
- Since you can seamlessly move back and forth between the steps, this method flexibly supports any type of creative idea without requiring complex operations.
- You can record and accumulate as many patterns as you please, just as though you were jotting on a scratchpad, so it's an easy way to let your ideas take shape.
- Since you can export your material as SMF data from any stage in this process, it's easy to move your production environment between systems. For example, you could create the basis of your song on the FANTOM, and then carry out the mastering and mixdown using DAW software on your computer.

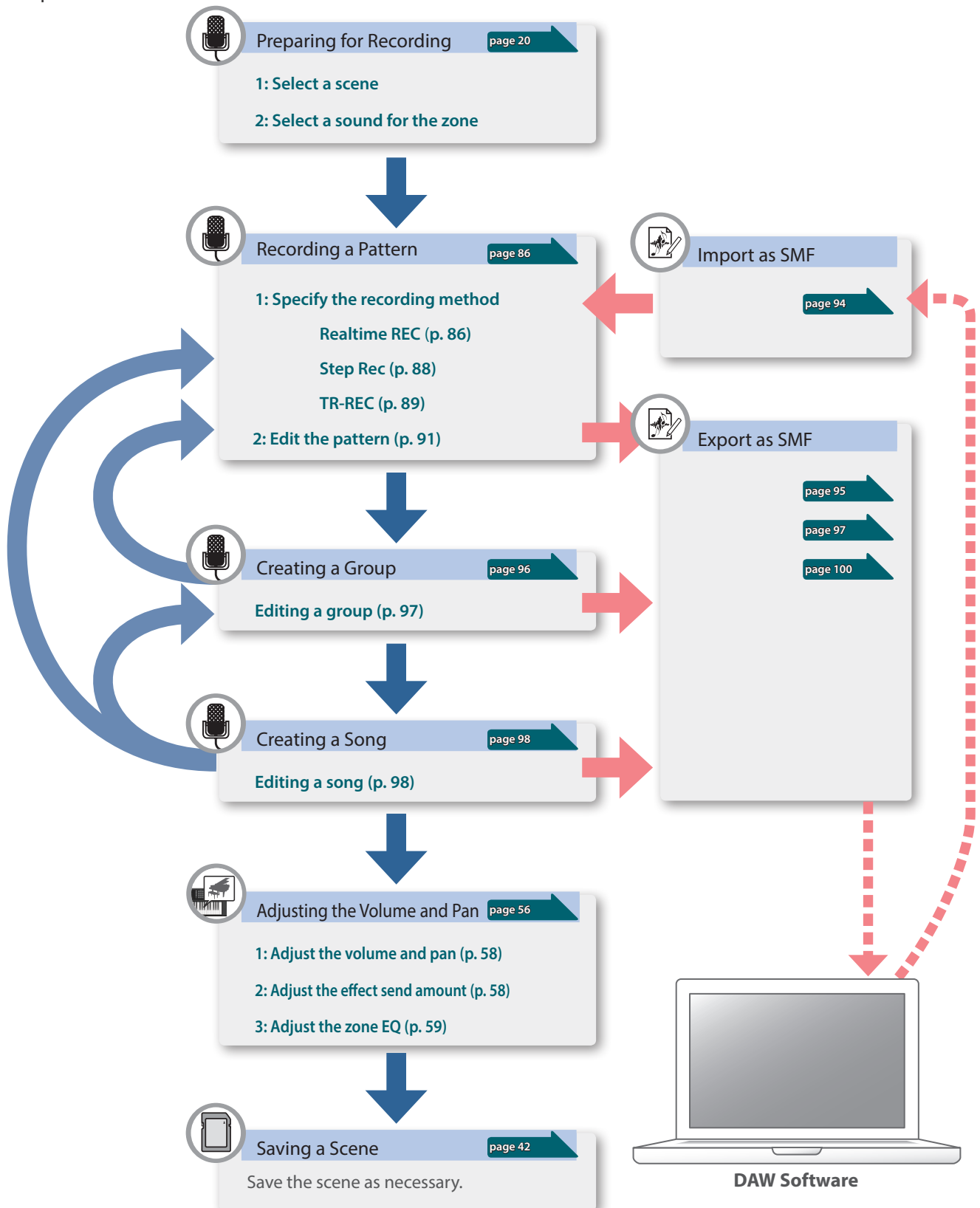

# Recording a Pattern

## Ways to Record a Pattern

There are three ways to record a pattern.

<b>Realtime recording</b> (Realtime REC)	Create a pattern by recording your keyboard performance and controller operations just as you perform them.
<b>Step recording</b> (Step Rec)	Create a pattern by successively recording your keyboard performance one step at a time.
<b>TR-REC</b>	This method lets you place notes of each instrument on the steps at which you want them to be heard. This method is suitable for creating drum patterns.

## Preparing for Recording

Here's how to prepare for recording a pattern.

### 1. Select a scene (p. 22).

Patterns, groups, and songs are stored for each scene. Some of the scenes provided with the factory settings contain patterns and songs. If you want to start with a blank state and make a new recording from scratch, delete the existing patterns (DELETE ALL) as described in "Deleting Patterns (DELETE)" (p. 91), or select one of the empty scenes (INITIAL SCENE) of number C017 and follows.

#### NOTE

A deleted pattern cannot be recovered. If you create a pattern and then switch to another scene or turn off the power without saving the scene, the data you created is lost.

### 2. Select a sound (tone) for the zone (p. 23).

In advance, it's a good idea to decide generally which instruments will be assigned to which zones. If you want to record layered tones, you should also make layer settings in advance. You can also change the selected tone afterward.

## Realtime Recording (Real Time REC)

### 1. Press the [●REC] button.

The REC STANDBY screen appears.





#### NOTE

Although recording operations can be done even while a pattern is playing, you can't perform recording operations from the GROUP screen or the SONG screen.

### 2. Make settings for recording.

Directly touch parameters in the screen to select them, or use the [VALUE] dial to edit the value.

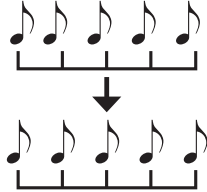
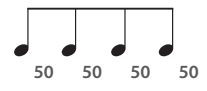

Recording Parameter	Value	Explanation
<Count In>		Selects the way in which recording is started.
	NONE	Recording begins immediately when you press the [▶PLAY] button.
	1 MEAS	When you press the [▶PLAY] button, a count begins from one measure before the recording start location; recording begins when the recording start location is reached.
	2 MEAS	When you press the [▶PLAY] button, a count begins from two measures before the recording start location; recording begins when the recording start location is reached.
	WAIT NOTE	Recording begins when you press the [▶PLAY] button, or when you press a key, press a pad, or press the hold pedal.
<Time Signature>	4/4, 3/4	Specifies the time signature. This can be specified if all patterns are empty.
<Input Quantize>		Quantize is a function that automatically corrects inaccuracies in the timing at which you play the keyboard or the pads, tightening-up the rhythmic accuracy. You can apply the quantize function during realtime recording. This setting specifies whether quantize will be applied during recording.
	OFF	Quantize is not applied during recording.
	GRID	Grid quantize is applied during recording. Use this when you need accurate timing, such as for drums or bass. 
	SHUFFLE	Shuffle quantize is applied during recording. Use this when you want a bouncy rhythm such as shuffle or swing.
Resolution [E5] knob		Specifies the note timing value at which quantization is applied. GRID: 1/32 (♩)–1/4 (♩) SHUFFLE: 1/16 (♩)–1/8 (♩)
Strength [E6] knob	0–100%	This setting is used with grid quantize. It specifies the degree to which your notes are moved to precise intervals of the note values specified by the RESOLUTION setting. If this is set to "100%," the notes that you record are moved all the way to exact intervals of the specified RESOLUTION. With lower percentages, less correction is applied. If this is set to "0%," the timing is not corrected at all.
Rate [E6] knob	0–100%	This setting is used with shuffle quantize. If this is set to "50%," the notes sound at equal intervals. Raising the value produces a bouncy feel as with dotted notes. Rate=50%  Rate=90% 
<RHY SYNC>	OFF, ON	Specifies whether the currently selected rhythm pattern is automatically played and recorded (ON) or not recorded (OFF) when recording starts. (p. 33)
<LOOP REC SW>	ON, OFF	Continue recording even after you've recorded the measures specified by the Length setting. Transition from recording to playback when you've recorded the measures specified by the Length setting.

Recording Parameter	Value	Explanation
<REC EVENT>		Lets you select the performance data that is recorded during realtime recording.
	NOTE	Note messages
	CONTROL CHANGE	Control change messages
	PITCH BEND	Pitch bend messages
	CHANNEL AFTER	Channel aftertouch messages
	POLY AFTER	Polyphonic aftertouch messages
[E5] CLICK	OFF, ON	Turns the click (metronome) on/off.
Tempo [E4] knob	$\text{♩} = 5-300$	Specifies the tempo.
Length [E3] knob	1-32	Specifies the length of the pattern.

### 3. Make TRACK/PATTERN settings.

Recording Parameter	Value	Explanation
NEW/MIX	MIX	Overdub-record onto the pattern of the selected track.
	NEW	Newly record onto an empty pattern of the selected track.
TRACK	1-16	Indicates the track to record.
PATTERN	A-H	Indicates the pattern of the track to record.

In the example shown in the illustration below, TRACK 1-B is selected. Of patterns A-H, the selected pattern is enclosed by a red frame.

Already-recorded patterns are solid blue.

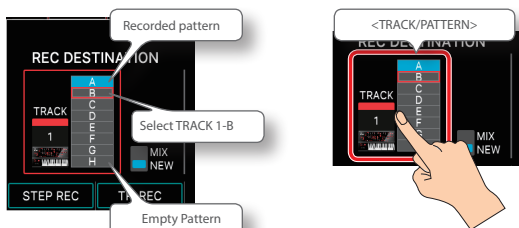

When you touch <TRACK/PATTERN>, you move to the PATTERN screen, where you can select the track (1-16) and pattern (A-H) to record. You can select the track and pattern by using the [▲] [▼] [◀] [▶] buttons to move the red frame, or by directly touching a vacant area in the screen.

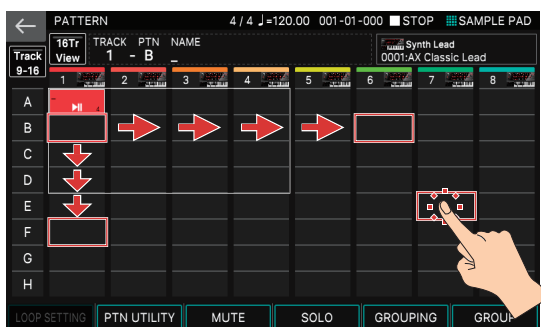

Since zones and tracks correspond with each other, using the ZONE SELECT buttons to switch the current zone also changes the recording-destination track in tandem. If you change the recording-destination track, the zone played by the track also changes in tandem.

(Example) Zone 2 (Bass): Track 2 → Zone 10 (Drum): Track 10

### 4. Press the [●REC] button.

### 5. Press the [▶PLAY] button to start recording.

You can also start recording by touching <START>.

The REALTIME RECORDING screen appears.

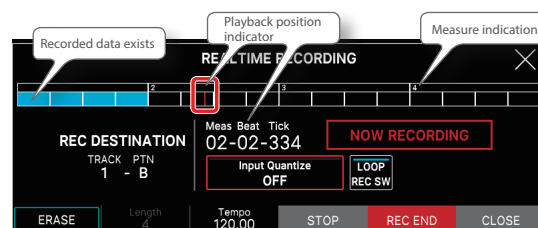

### 6. Play the keyboard.

Knob and controller operations are also recorded.

You can use the following functions while recording.

Menu	Explanation
ERASE [E1]	Accesses the realtime erase screen.
Length [E2]	Indicates the length of the pattern. This value cannot be changed.
Tempo [E3] knob	Lets you change the tempo during recording. Tempo data is not recorded even if you change it.
STOP [E4]	Stops recording and returns to the PATTERN screen.
REC END [E5]	Enters playback mode, and moves to the REC STANDBY screen.
CLOSE [E6]	Returns to the previous screen while remaining in recording mode.
<Input Quantize>	Lets you switch this function on/off or change its settings during recording.
<LOOP REC SW>	Lets you switch this function on/off during recording.

### 7. Press the [■STOP] button to stop recording.

When you have finished recording, repeat steps 1-5 as necessary to record variation patterns on the same track or to record on another track.

When creating a group or song in the next section, it's a good idea to divide it into several tracks and create several patterns so that the differences are easy to understand.

## Removing Unwanted Data During Recording (Realtime Erase)

Realtime erase is a function lets you erase unwanted data during realtime recording. In particular when LOOP REC SW is "on," you can use this to conveniently erase just an unwanted portion while you continue recording.

### 1. Start realtime recording (p. 86).

### 2. In the REALTIME RECORDING screen, select [E1] ERASE.

The REALTIME ERASE screen appears.



### 3. Erase unwanted data.

Operation	Explanation
Erase all data	Press the [E1] knob <ERASE ALL>. The data is erased while you hold down the button.
Erase notes of a specific key	Press the corresponding key. The data is erased while you hold down the key.
Erase notes of a specific range of keys	Press the top and bottom key of the range. The data is erased while you hold down the keys.

### 4. Select [E6] CLOSE.

You return to the REALTIME RECORDING screen.

## Step Recording (Step REC)

### 1. Press the [●REC] button.

The REC STANDBY screen appears.



### 2. Make TRACK/PATTERN settings.



Recording Parameter	Value	Explanation
<NEW/MIX>	MIX	Overdub-records into the pattern of the selected track.
	NEW	Newly records into an empty pattern of the selected track.
<TRACK>	1-16	Selects the track to record.
<PATTERN>	A-H	Selects the pattern of the track to record.

Using the same operations as in step 3 of "Realtime Recording," select the track and pattern that you want to record.

### 3. Select [E1] STEP REC.

The STEP RECORDING screen appears.

### 4. Make settings for the notes that you want to enter.

Set the various recording parameters in the screen.

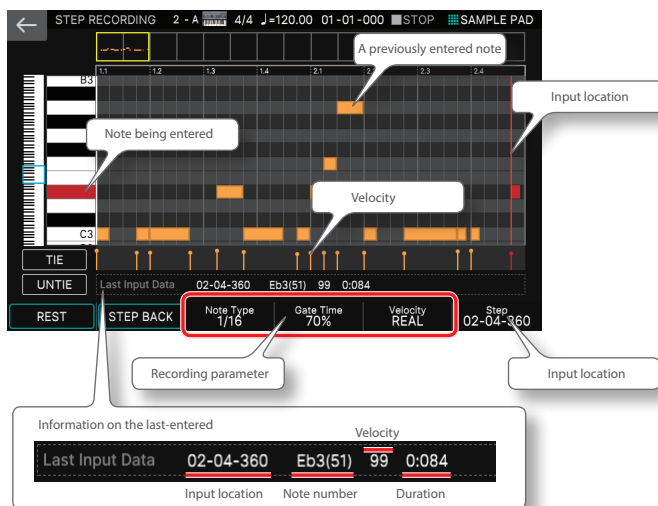

Recording Parameter	Value	Explanation
Note Type [E3] knob	1/64 (♪) - 2/1 (♩)	Specifies the note length (step time) of the notes to enter. The note length is the length from one note-on to the next note-on. This step time length is also used when entering a rest or tie.
Gate Time [E4] knob	1-100%	Specifies the gate time as a proportion of the note type. The gate time is the length from note-on to note-off. Use a low value to produce staccato, or a high value to produce tenuto or slurs. Normally you'll use a setting of approximately "80%."
Velocity [E5] knob	REAL, 1-127	Specifies the force with which the key is played. If you want the velocity of your actual keystroke to be used, choose "REAL." Otherwise specify the desired velocity, using p (piano) = 60, mf (mezzo forte) = 90, and f (forte) = 120 as approximate guidelines.

### 5. Play one note on the keyboard.

The note is recorded at step 1, and the input position in the screen automatically advances by the length of the step time.

You can record a chord by playing multiple notes simultaneously.

### 6. Repeat steps 4-5 to record each step.

You can use the following functions while recording.

Menu	Explanation
[E1] REST	Enters a rest.
STEP BACK [E2]	Deletes the step data, returning to the input location one step earlier.
Step [E6] knob	Changes the input location.
<TIE>	Inputs a tie.
<UNTIE>	Deletes the tie that was input immediately before.

If you step-record beyond the specified length of the pattern, the recording parameter "Length" is automatically adjusted.

### 7. Press the [EXIT] button to stop recording.

#### MEMO

- By scrolling the keyboard area in the left side of the screen, you can move the displayed area up or down.
- By using the piano roll scrollbar in the upper part of the screen, you can move the displayed area forward or backward through the measures.

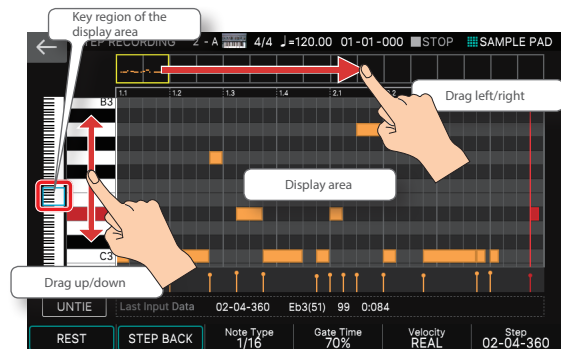



### How note value and step time are related

The following table shows how note value and gate time are related. On the FANTOM's sequencer, the TPQN (ticks per quarter note) resolution is 480. This means that a quarter note has a gate time of 480 ticks.

Note	Step time	Note	Step time
	30		240
	40		320
	45		360
	60		480
	80		640
	90		720
	120		960
	160		1920
	180		3840

**MEMO**

The gate time that is recorded during step recording is the original step time value multiplied by the GATE TIME value. For example if GATE TIME is set to 80% and you enter a quarter note, the gate time is  $480 \times 0.8 = 384$ .

## TR-REC

### What is TR-REC?

TR-REC is the method of using the TONE CATEGORY buttons [1]–[16] to specify the timing at which each instrument will sound. You can use it while listening to a rhythm that you yourself created. For example to create the drum pattern shown in figure 1, you would make the settings shown in figure 2.

figure 1

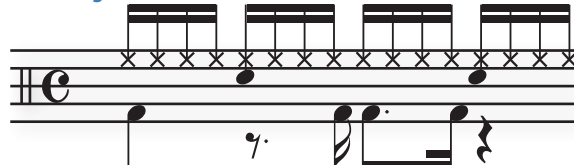

figure 2

Step Number	01	02	03	04	05	06	07	08	09	10	11	12	13	14	15	16
Closed Hi-Hat	■	■	■	■	■	■	■	■	■	■	■	■	■	■	■	■
Snare Drum	□	□	□	□	□	□	□	□	□	□	□	□	□	□	□	□
Bass Drum	■	□	□	□	□	□	□	□	□	□	□	□	□	□	□	□

■ Button lit  
□ Button unlit

For the Drum Kit tone, playing an instrument on the keyboard makes the TONE CATEGORY buttons [1]–[16] light or go dark to indicate the steps on which that instrument will sound. Pressing one of the TONE CATEGORY buttons [1]–[16] switches it between lit and unlit, changing whether the instrument will or will not sound on that step.

### 1. Press the [●REC] button.

The REC STANDBY screen appears.



### 2. In <TRACK/PATTERN>, note the track that you'll be recording.



Recording Parameter	Value	Explanation
NEW/MIX	MIX	Overdub-records onto a pattern of the selected track.
	NEW	Newly records into an empty pattern of the selected track.
TRACK	1–16	Selects the track to record.
PATTERN	A–H	Selects the pattern of the track to record.

As described in step 3 of "Realtime Recording," select the track and pattern that you want to record.

### 3. Select [E2] TR-REC.

The TR-REC screen appears. The [TR-REC] button is lit, and tone category buttons [1]–[16] change to functioning as the TR-REC step buttons.

**MEMO**

You can also access the TR-REC screen by pressing the [TR-REC] button instead of the [REC] button.

### 4. Make TR-REC settings.

Set the various recording parameters in the screen.

**Tone**

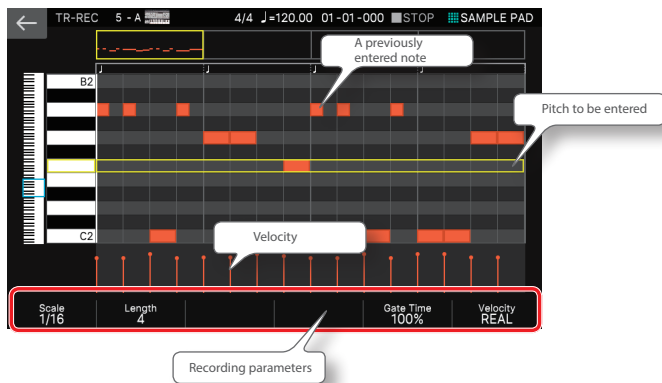

**Drum Kit tone**

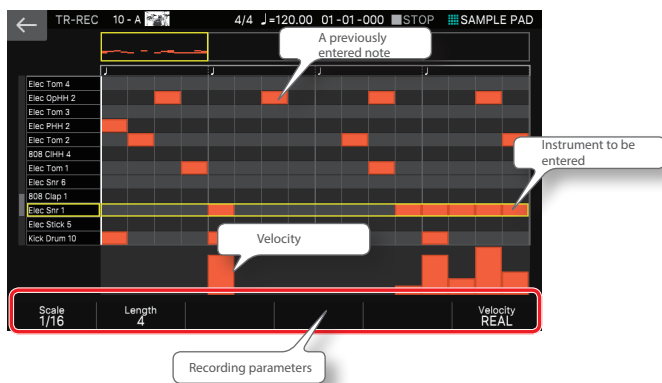

Recording Parameter	Value	Explanation
Scale	1/16:	Four steps make one beat.
	1/32:	Eight steps make one beat.
	1/12T:	Three steps make one beat.
	1/24T:	Six steps make one beat.
Length	1–32	Specifies the length of the pattern.
Gate Time	1–100%	Specifies the gate time as a proportion of the scale. The gate time indicates the time from note-on to note-off. Specify a lower value to create staccato, or a higher value to create tenuto or a slur. Normally you can leave this at about 80%.
Velocity	REAL, 1–127	Specifies the strength with which the key is pressed. If you want to enter the velocity value with which you actually press the key, set this to "REAL." Otherwise, specify the desired velocity, using p (piano)=60, mf (mezzo forte)=90, and f (forte)=120 as approximate guidelines.

### 5. Use the keyboard to specify the instrument that you want to record (only for a drum kit tone).

The instrument changes when you press a key of a different pitch.

- For tones other than a drum kit, use the keyboard to specify the pitch that you want to input.
- When you specify an instrument or pitch, the yellow frame in the screen moves correspondingly.

### 6. Press the tone category buttons [1]–[16] to illuminate the steps at which you want a note to play.

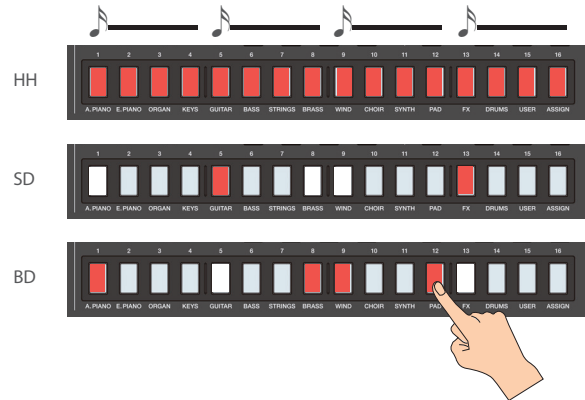

Notes are entered at the corresponding step locations in the screen.

To delete a note, press a lit tone category button [1]–[16] to make it go dark.

You can also press the [▶] [PLAY] button and enter notes while the pattern plays.

### 7. You can change the input position by holding down the [SHIFT] button and pressing a tone category button [1]–[16].

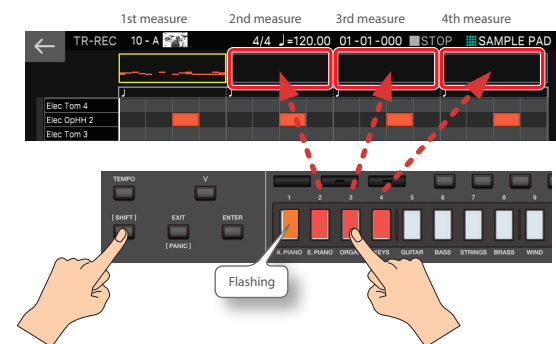

### 8. Press the lit [TR-REC] button to stop recording.

**MEMO**

- You can't enter TR-REC mode during realtime recording or step recording.
- By scrolling the keyboard (instrument) area in the left of the screen, you can move the displayed area up/down.
- By using the scroll bar of the piano roll in the upper part of the screen, you can move the displayed area forward or backward through the measures.

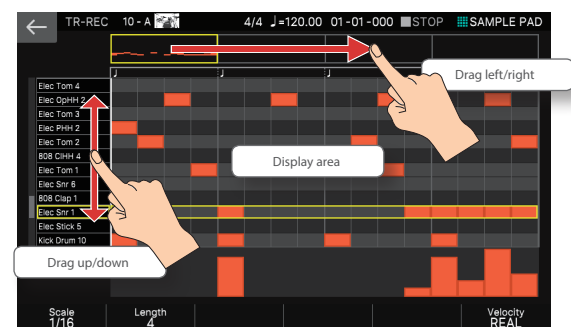

## Editing a Pattern

### Convenient Functions (Pattern Utility)

By using pattern utility functions, you can copy and paste a selected pattern to modify the overall structure, or you can delete unneeded patterns. Other useful functions are also provided, such as assigning a name to each pattern so that it can be easily distinguished.

#### Basic pattern utility operation

#### 1. In the PATTERN screen, select [E2] PTN UTILITY.

The PTN UTILITY screen appears.

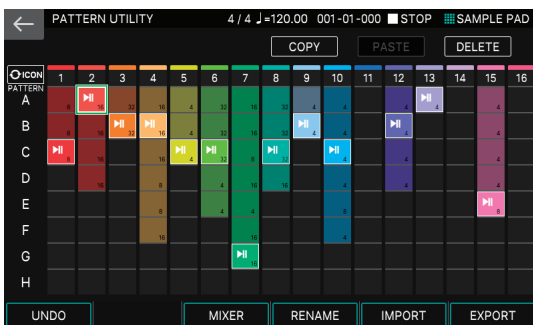

Only the 16-track view is available for the PTN UTILITY screen.

#### 2. Select the patterns for which you want to execute a function.

The selected pattern box is enclosed in a green border. You can select a pattern by using the cursor [▲] [▼] [◀] [▶] buttons or by directly touching a pattern box.

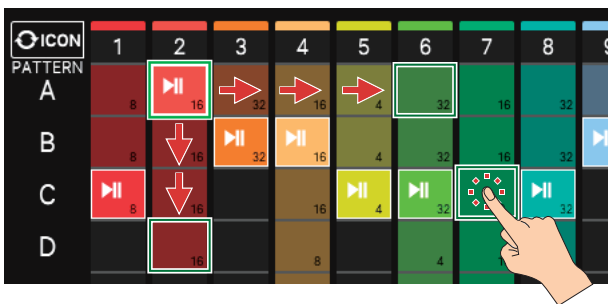

#### 3. Using the icon in the upper right of the screen or knobs [E1]–[E6], select the operation that you want to execute.

#### 4. Edit the settings of the menu item you selected.

Menu	Explanation
<COPY>	Copies a pattern.
<PASTE>	Pastes a copied pattern to a different location.
<DELETE>	Deletes a pattern.
<MODIFY>	Applies various edits to a pattern.
[E1] UNDO/REDO	Cancels an editing operation.
[E3] MIXER	Accesses the mixer screen.
[E4] RENAME	Edits the name of each pattern.
[E5] IMPORT	Converts an SMF file from a USB flash drive and
[E6] EXPORT	Converts a pattern into an SMF file and writes it to a USB flash drive.

#### 5. Press the [EXIT] button to return to the PATTERN screen.

#### MEMO

The content that you edit using the pattern utility functions is saved in the scene.

#### Copying a pattern (COPY)

Here's how to copy the selected pattern. Use this in conjunction with PASTE

#### 1. In the PTN UTILITY screen, select the pattern that you want to copy, and touch <COPY> in the upper right of the screen.

The contents of the selected pattern are copied.

#### Pasting the copied pattern (PASTE)

Here's how a copied pattern can be pasted in a different location. You must execute the Copy function in advance.

#### 1. In the PTN UTILITY screen, select the pattern box to which you want to copy, and then touch <PASTE> in the upper right of the screen.

The contents of the copied pattern are pasted.

You can paste into a different track that the original track, or to a location that already contains a pattern. If the location already contains a pattern, the original pattern is overwritten.

#### NOTE

You can't execute this if the <PASTE> icon is grayed-out.

#### Deleting a pattern (DELETE)

Here's how to delete the selected pattern.

#### 1. In the PTN UTILITY screen, select the pattern that you want to delete, and then touch <DELETE> in the upper right of the screen.

The DELETE MENU appears.

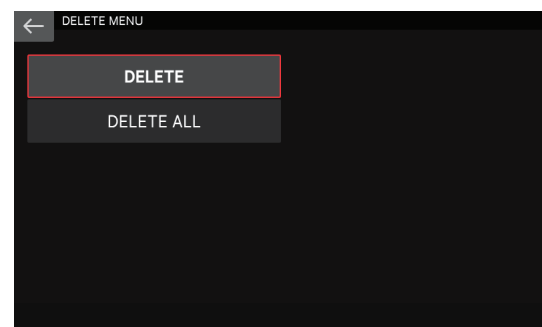

Menu	Explanation
DELETE	Deletes only the currently selected pattern.
DELETE ALL	Deletes the patterns from all tracks in the scene. Undo is not available for this operation.

#### 2. Touch the function that you want to execute.

A confirmation message appears.

#### 3. Select [E5] OK.

If you decide to cancel, choose [E6] CANCEL.

### Undoing an editing operation (UNDO)

Here's how to cancel the result of an editing operation and return to the state before that operation was executed (Undo). You can also cancel the Undo operation (Redo).

#### 1. In the PTN UTILITY screen, select [E1] (UNDO indication).

The previous editing operation is cancelled, and the data returns

#### 2. If you want to cancel the Undo operation and return to the original state, press [E1] (REDO indication) once again.

##### NOTE

- This cannot be executed if the [E1] UNDO text is grayed-out.
- Undo is not available for the DELETE ALL operation.

### Naming a pattern (RENAME)

Here's how to assign a name to each pattern. If you assign an informative name, you'll be able to distinguish patterns without needing to specifically examine the content of each pattern.

#### 1. In the PTN UTILITY screen, select the pattern that you want to rename, and then select [E4] RENAME.

The RENAME screen appears.

#### 2. Edit the pattern name as described in the explanation for the RENAME screen (p. 13).

#### 3. Select [E6] OK.

If you decide to cancel, choose [E5] CANCEL.

## Applying Various Edits (MODIFY)

The PATTERN UTILITY command MODIFY lets you specify parameters for various operations. You can use it to apply various edits such as applying quantization to a previously-recorded pattern, or deleting only specific types of data.

### Basic operation for Modify

#### 1. In the PTN UTILITY screen, select the pattern that you want to modify, and then touch <MODIFY> in the upper right of the screen.

The MODIFY MENU appears.

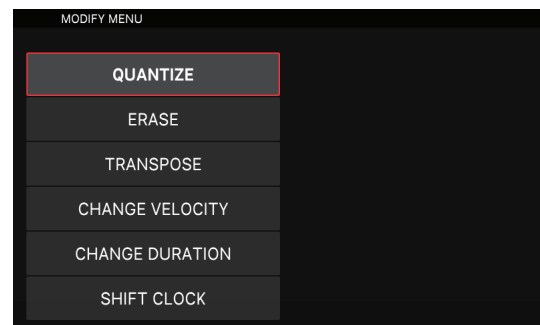

Menu	Explanation
DELETE	Deletes only the currently selected pattern.
DELETE ALL	Deletes the patterns of all tracks in the scene. Undo is not available for this operation.

#### 2. Touch the function that you want to execute.

A setting screen for that function appears.



#### 3. Select the necessary parameters, and edit their values.

#### 4. Select [E6] EXECUTE.

A confirmation message appears.

If you decide to cancel, choose [E5] CANCEL.

#### 5. Select [E5] OK.

If you decide to cancel, choose [E6] CANCEL.

### Correcting the timing of a pattern (QUANTIZE)

This function quantizes an already-recorded pattern.

##### MEMO

Quantize corrects only the timing at which you press a key (note-on) and the timing at which you release a key (note-off); it does not correct the timing of other performance data. This means that you may experience unintended results if performance data such as pitch bend or modulation is shifted away from the notes to which it originally applied.

Parameter	Value	Explanation
TARGET	LOOP	Changes apply to the region specified in LOOP SETTING (p. 82).
	PATTERN	Changes apply to the selected pattern.

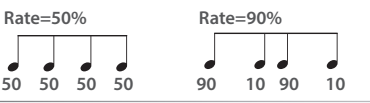
Parameter	Value	Explanation
<Quantize Type>	GRID	Specifies how quantization will occur. Grid quantization is applied during editing. Use this when you want accurate timing, such as for drums or bass. 
	SHUFFLE	Shuffle quantization is applied during editing. Use this when you want to give the rhythm a sense of shuffle or swing.
Resolution [E1] knob	GRID: 1/32 (♩)–1/4 (♩) SHUFFLE: 1/16 (♩)–1/8 (♩)	Specifies the quantization timing as a note value. If you're using grid quantize, choose the shortest note value that occurs in the region that you're quantizing.  * If you apply shuffle quantize to performance data that has significant discrepancies in timing, you might not obtain the result you expect. In this case, first apply grid quantize to the original performance data so that it is aligned according to the musical score, and then apply shuffle quantize to obtain the desired effect.
Strength [E2] knob	0–100%	Use this setting when applying grid quantize. It specifies how greatly the notes will be moved toward intervals of the note value specified by Grid Resolution. If this is set to "100%" notes will be moved all the way to precise intervals of the Grid Resolution timing. With lower values, less timing correction is applied to the notes. With a setting of "0%" no timing correction is applied.
Rate [E2] knob	0–100%	Use this setting when applying shuffle quantize. If this is set to 50%, notes will sound at equal spacing. As this value is increased, you obtain a bouncy effect as with dotted notes. 
RANGE MIN [E3] knob	0 (C-1)	Specifies the lower limit of the range of notes that is quantized.
RANGE MAX [E4] knob	–127 (G9)	Specifies the upper limit of the range of notes that is quantized.

## Erasing Unwanted Performance Data (ERASE)

All performance data of the specified type is erased. Since the erased performance data is replaced by rests, the length of the pattern does not change.

Parameter	Value	Explanation
TARGET	LOOP	Changes apply to the region specified in LOOP SETTING (p. 82).
	PATTERN	Changes apply to the selected pattern.
<Event>		Selects the performance data that is erased.
	All	All performance data
	Note	Note messages
	Control Change	Control change messages
	Pitch Bend	Pitch bend messages
	Poly Aftertouch	Polyphonic aftertouch messages
	Channel Aftertouch	Channel aftertouch messages
RANGE MIN [E3] knob		Specifies the lower limit of the region that is erased.
RANGE MAX [E4] knob	0 (C-1) –127 (G9)	Specifies the upper limit of the region that is erased.
		If EVENT is set to "Note," "Poly Aftertouch," or "Control Change," you can specify the range of values. Range Min specifies the minimum value of the range, and Range Max specifies the maximum value of the range.  <b>MEMO</b> <ul style="list-style-type: none"> <li>If you want to erase all notes or all polyphonic aftertouch data, set Range Min to "C1" and Range Max to "G9." If you want to erase "C4," set both Range Min and Range Max to "C4." If you want to erase from "C3" through "C4," set Range Min to "C3" and Range Max to "C4."</li> <li>If you want to erase all controller numbers, set Range Min to "0" and Range Max to "127."</li> </ul>

## Transposing (TRANPOSE)

This function transposes the notes of the specified region in a range of  $\pm 24$  semitones.

Parameter	Value	Explanation
TARGET	LOOP	Changes apply to the region specified in LOOP SETTING (p. 82).
	PATTERN	Changes apply to the selected pattern.
BIAS [E1] knob	–127–127	Specifies the amount of transposition in semitone units.
RANGE MIN [E3] knob		Specifies the lower limit of the region of notes that is transposed.
RANGE MAX [E4] knob	0 (C-1) –127 (G9)	Specifies the upper limit of the region of notes that is transposed.

## Changing the Velocity (CHANGE VELOCITY)

This function changes the keyboard dynamics (velocity) in the specified region.

Parameter	Value	Explanation
TARGET	LOOP	Changes apply to the region specified in LOOP SETTING (p. 82).
	PATTERN	Changes apply to the selected pattern.
BIAS [E1] knob	–127–127	Specifies the amount by which the recorded velocity is changed.
RANGE MIN [E3] knob		Specifies the lower limit of the region of notes that is modified.
RANGE MAX [E4] knob	0 (C-1) –127 (G9)	Specifies the upper limit of the region of notes that is modified.

## Changing the Duration of the Notes (CHANGE DURATION)

This function changes the duration (the time from note-on to note-off) of the notes in the specified region. You can use this conversion to give the performance a more staccato or tenuto feel.

Parameter	Value	Explanation
TARGET	LOOP	Changes apply to the region specified in LOOP SETTING (p. 82).
	PATTERN	Changes apply to the selected pattern.
BIAS [E1] knob	–127–127	Specifies the amount by which the note duration is changed.
RANGE MIN [E3] knob		Specifies the lower limit of the region of notes that is modified.
RANGE MAX [E4] knob	0 (C-1) –127 (G9)	Specifies the upper limit of the region of notes that is modified.

### Moving Performance Data Forward or Backward (SHIFT CLOCK)

This function moves the timing of performance data in the specified region forward or backward in units of ticks. By slightly moving the performance data you can give the performance a “rushing” or “dragging” feel.

If the Shift Clock function would cause data to be moved beyond the beginning of the song, such data is moved to the beginning of the song.

Parameter	Value	Explanation
TARGET	LOOP	Changes apply to the region specified in LOOP SETTING (p. 82).
	PATTERN	Changes apply to the selected pattern.
Event	Selects the performance data that is moved.	
	All	All performance data
	Note	Note messages
	Control Change	Control change messages
	Pitch Bend	Pitch bend messages
	Poly Aftertouch	Polyphonic aftertouch messages
	Channel Aftertouch	Channel aftertouch messages
BIAS [E1] knob	-127-127	Specifies the number of ticks by which the data is shifted.

### Importing SMF as a Pattern (IMPORT)

Here’s how SMF data can be imported as a pattern. The imported SMF data can be handled as a pattern in the PATTERN screen.

**MEMO**

In advance, copy an SMF file from your computer to the desired folder of a USB flash drive.

**1. In the PTN UTILITY screen, select [E5] IMPORT.**

The SMF IMPORT screen appears. The import-destination can be a location that already contains a pattern. In this case, the original pattern is overwritten.

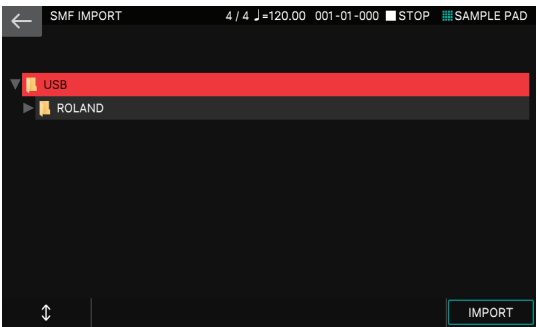

**2. Select the SMF file that you want to import.**

The selected file is highlighted. You can use the following operations to select the file.

Operation	Explanation
Touching a file name in the screen	Directly selects the file that you touched.
[E1] knob [▲] button [▼] button	Scroll up/down to select a file.
[ENTER] button	Expands the contents of a folder. Press once again to hide the expanded contents.
[▶] button	Expands the contents of a folder.
[◀] button	Hides the expanded contents.
[EXIT] button	Returns to the previous screen.

**3. Select [E6] IMPORT.**

The SMF IMPORT screen appears.



Menu	Explanation
Start [E1] knob	Specifies the starting measure of the SMF to be imported.
Length [E2] knob	Specifies the number of measures of the SMF to be imported.
Destination [E3] knob	Specifies the import-destination track.
[E4] EDIT NAME	Renames the pattern name after importing.

**4. Select [E6] OK.**

The selected file is highlighted. You can use the following operations to select the file. If you decide to cancel, choose [E5] CANCEL.

## Exporting a Pattern as SMF (EXPORT)

Here's how a pattern of the currently selected scene can be converted into SMF data and exported to a USB flash drive.

### 1. In the PTN UTILITY screen, select [E6] EXPORT.

The SEQ EXPORT screen appears.

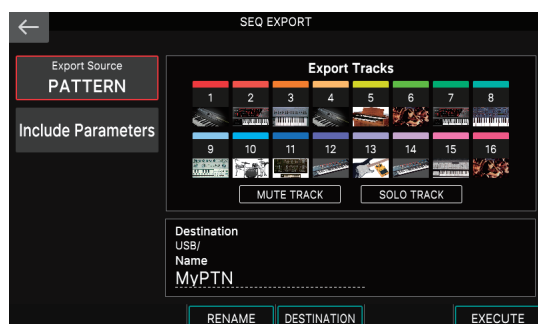

### 2. In the upper left of the screen, touch <EXPORT SOURCE> and select "PATTERN" as the source.

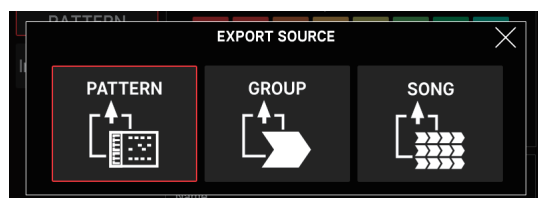

In addition to exporting an individual pattern, you can also export by group or by song (p. 97) (p. 100).

### 3. In the upper left of the screen, touch <INCLUDE PARAMETER> and select the parameters that will be included in the exported data.

Parameter	Explanation
Tempo	Include the pattern's tempo data in the export.
Level	Include the pattern's level data in the export.
Pan	Include the pattern's pan (stereo position) data in the export.

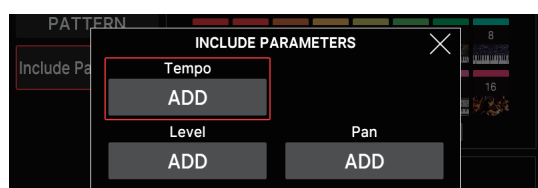

### 4. After you select the necessary items in INCLUDE PARAMETER, press the [EXIT] button.

You return to the SEQ EXPORT screen.

### 5. In the Export Tracks field, select the tracks that will be exported. Touch <MUTE TRACK> or <SOLO TRACK>.

The MUTE SELECT screen or the SOLO SELECT screen appears.

### 6. Select tracks in the same way as when "Muting a Track" (p. 83) or "Soloing a Track" (p. 83).

Patterns of the tracks that are not muted (or are soloed) are exported. If multiple variations exist in the applicable track, all variations are exported.

### 7. Select the necessary tracks, and press the [EXIT] button.

You return to the SEQ EXPORT screen.

### 8. Select [E3] RENAME.

The RENAME screen appears.

### 9. Enter a file name as described in the procedure for the RENAME screen (p. 13).

When you execute EXPORT, individual consecutively-numbered SMF files are created starting with the file name that you enter.

Example: If you assign "MyPTN" as the file name, SMF files with the following names are created.

MyPTN\_01-A.MID SMF of track 1 pattern A  
 MyPTN\_01-B.MID SMF of track 1 pattern B  
 MyPTN\_02-A.MID SMF of track 2 pattern A

\* If you proceed without assigning a name, the scene number is automatically used as the file name.

### 10. Select [E6] OK.

You return to the SEQ EXPORT screen.

### 11. Select [E4] DESTINATION.

The EXPORT DESTINATION screen appears.

### 12. Select the export-destination folder.

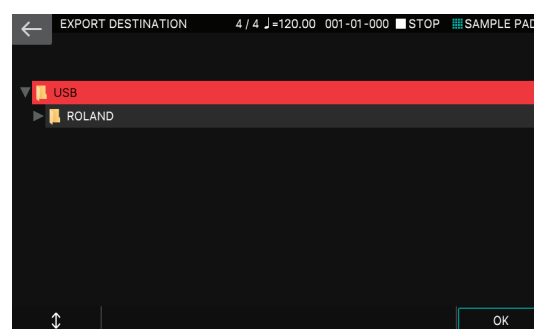

The selected folder is highlighted. You can use the following operations to select the folder.

Operation	Explanation
Touching a file name in the screen	Directly selects the folder that you touched.
[E1] knob [▲] button [▼] button	Scroll up/down to select a folder.
[ENTER] button	Expands the contents of a folder. Press once again to hide the expanded contents.
[▶] button	Expands the contents of a folder.
[◀] button	Hides the expanded contents.
[EXIT] button	Returns to the previous screen.

### 13. Select [E6] OK.

You return to the SEQ EXPORT screen.

### 14. Select [E6] EXECUTE.

First, a folder of the same name as the file name you entered is created in the folder specified by EXPORT DESTINATION, next a folder named according to the EXPORT SOURCE ("PTN," "GRP" "SNG") is created inside the first folder, and then the SMF files are created inside the next folder.

\* If the export destination already contains files of the same name, a confirmation screen asks whether you want to overwrite them.

### 15. Press the [EXIT] button to return to the PTN UTILITY screen.

## Saving a Pattern

Pattern data that you create is saved together in the current scene. If you want to keep a pattern that you create, save the scene (p. 44).

# How to Create a Group

## Creating a Group

In advance, select a scene and create patterns in several tracks as described in the procedure for recording a pattern (p. 86).

### 1. Press the [PATTERN] button.

The PATTERN screen appears.



### 2. Select a pattern for each track to specify the combination.

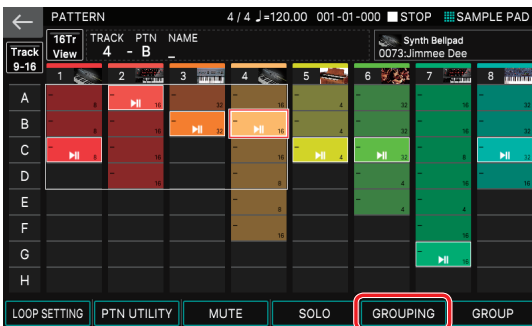

In this example, the current pattern of each track is as follows.

Track 1-C	Track 2-A	Track 3-B	Track 4-B
Track 5-C	Track 6-C	Track 7-G	Track 8-C

### 3. Select [E5] GROUPING.

The GROUPING screen appears.

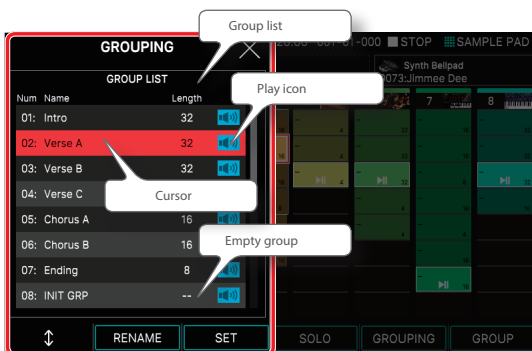

Groups whose "Length" field is "-" are empty groups that are not grouped.

### 4. Use the [E1] to move the cursor to the number that you want to assign.

### 5. Select [E3] SET.

A confirmation message appears.

If you decide to cancel, choose [E6] CANCEL.

### 6. To execute, select [E5] OK.

The current combination of each track's patterns is registered as a group.

### 7. Press the [▶PLAY] button.

You can audition the group you created to verify that it is the combination that you chose.

You can also audition by touching the <play icon> in the group list.

The GROUP PREVIEW screen is shown during audition. Like the PTN screen, the GROUP PREVIEW screen shows the current patterns of each track at a glance.

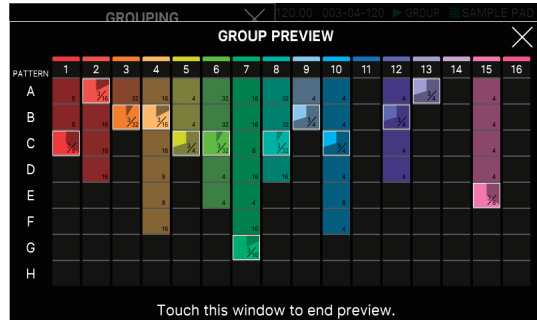

### 8. To stop playback, press the [■STOP] button.

You can also stop by touching the GROUP PREVIEW screen.

### 9. As necessary, repeat steps 2–6 to create the group.

#### MEMO

A maximum of 16 groups can be created in each scene.

## Naming a Group (RENAME)

You can assign a name to each group. Assigning an informative name helps you tell the groups apart. It's a good idea to assign a name to a group that you create.

#### NOTE

- You can't rename a group before creating it.
- The group name is a maximum of eight characters.

### 1. In GROUP LIST, select the group that you want to rename, and then select [E2] RENAME.

The RENAME screen appears.

### 2. Edit the group name as described in the procedure for the RENAME screen (p. 13).

### 3. Select [E6] OK.

If you decide to cancel, choose [E5] CANCEL.



## Editing a Group

Even after creating a group, you can edit the structure of the group in the GROUP screen.

### Basic Operation in the GROUP Screen

#### 1. Press the [GROUP] button.

The GROUP screen appears.



#### 2. Select a function and edit the parameters.

Function	Explanation
[E1] PATTERN	Accesses the PATTERN screen.
[E2] knob	Moves the cursor in GROUP LIST.
[E3] UTILITY	Accesses the GROUP UTILITY screen.
[E4] RENAME	Renames the group.
[E5] LENGTH	Edits loop settings for the group.
[E6] MAKE SONG	Accesses the MAKE SONG screen.

### Specifying the Loop Settings (Length)

The loop length of each group (Length) can be specified separately from the loop settings specified for a pattern. For example, the playback might loop in eight-measure units in the PATTERN screen, but you could halve this to make it loop in four-measure units when played as a group.

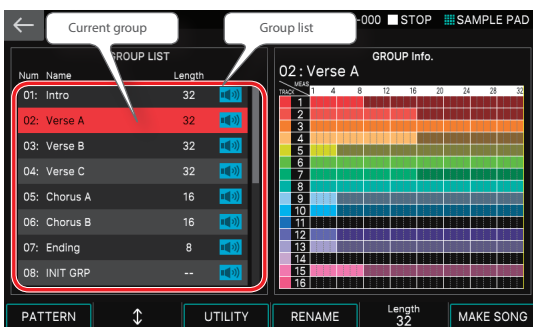

The right side of the screen is called the GROUP Info area. This area shows the presence or absence of data for each track in the current group, and the length of the current pattern for each track.

#### 1. Use the [E5] knob to set the Length parameter.

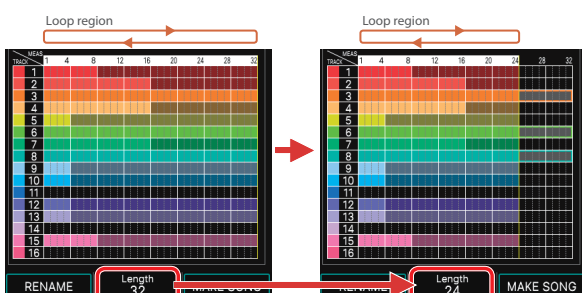

This changes the length for when the group is played.

The length is also shown in the GROUP Info. area. The area outside the region specified by Length is grayed-out and is not played.

### Naming a Group (RENAME)

You can assign a name to each group. Assigning an informative name helps you tell the groups apart without needing to specifically examine the content of each group.

#### 1. In the GROUP screen, select the group that you want to rename, and then select [E4] RENAME.

The RENAME screen appears.

#### 2. Edit the group name as described in the explanation for the RENAME screen (p. 13).

#### 3. Select [E6] OK.

If you decide to cancel, choose [E5] CANCEL.

### Initializing a Group (INITIALIZE)

Here's how to initialize a group.

#### 1. In the GROUP screen, select [E3] UTILITY.

The GROUP UTILITY screen appears.

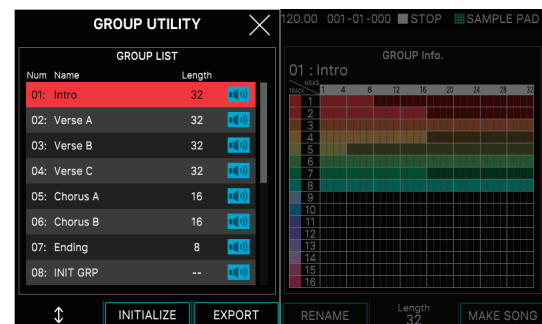

#### 2. Use the [E1] knob to select the group that you want to initialize.

#### 3. Select [E2] INITIALIZE.

The group is initialized.

#### 4. Press the [EXIT] button to return to the GROUP screen.

### Exporting a Group as SMF (EXPORT)

Here's how the patterns of a group in the currently selected scene can be converted into SMF data and exported to a USB flash drive.

#### 1. In the GROUP UTILITY screen, select [E3] EXPORT.

The SEQ EXPORT screen appears.

#### 2. Make settings in the SEQ EXPORT screen as described in steps 2–14 of “Exporting a Pattern as SMF (EXPORT)” (p. 95). In this case, select “GROUP” as the source.

#### 3. Press the [EXIT] button to return to the GROUP UTILITY screen.

### Saving a Group

The data of the groups you create is saved as a whole in the current scene. If you want to keep the groups you create, save the scene (p. 44).

# How to Create a Song

## Creating a Song

In advance, select a scene, and create patterns and groups as described in Recording a Pattern (p. 86) and Creating a Group (p. 96).

### 1. Press the [GROUP] button.

The GROUP screen appears.



### 2. Select [E6] MAKE SONG.

The MAKE SONG screen appears.

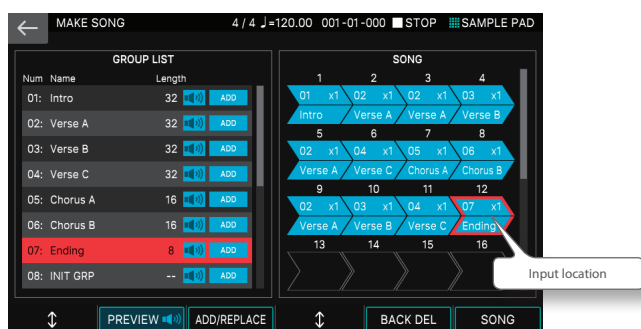

### 3. In the GROUP LIST at the left side of the screen, touch <ADD> for the group that you want to play first.

The group you touch is added to the SONG area in the right side of the screen, and the input location (red frame) advances by one position.

Menu	Explanation
[E1] knob	Moves the cursor in the GROUP LIST.
[E2] PREVIEW	Auditions the group selected by the cursor.
[E3] ADD/REPLACE	Switches the input method. If you input using REPLACE, the group at the input location is replaced.
[E4] knob	Moves the input location (red frame).
[E5] BACK DEL	Deletes the group at the input location (red frame) and moves the input location back by one position.
[E6] SONG	Accesses the SONG screen.
<Play icon>	Auditions the group whose icon you touch.

### 4. Repeat step 3 as necessary to create your song.

#### MEMO

- You can enter a maximum of 32 groups.
- Each scene can have one song.

#### NOTE

After creating groups or a song, the data you created will be lost if you switch to a different scene or turn off the power without saving the scene.

## Editing a Song

Even after creating a song, you can edit the song structure in the SONG screen.

### Basic Operation in the SONG Screen

#### 1. Press the [SONG] button.

The SONG screen appears.



#### 2. Select a function and edit the parameters.

Menu	Explanation
[E1] MAKE SONG	Accesses the MAKE SONG screen.
[E2] EDIT	Accesses the SONG EDIT screen.
[E3] DELETE	Deletes a group.
[E4] SKIP	Specifies whether a specific group is skipped when the song plays.
[E5] MEAS	Shows the timeline as measures.
[E6] EXPORT	Accesses the SEQ EXPORT screen.

### Skipping a Specific Group (SKIP)

In the SONG screen, the groups arranged in the screen will play consecutively, but you can make the playback skip a specific group. Since you can do this even while the song is playing, it is a convenient way to quickly and freely change the structure of the song.

#### 1. Press the [SONG] button.

The SONG screen appears.

#### 2. Select [E4] SKIP.

One of the group boxes that contain data is shown with a red frame.



#### 3. Use the cursor [▲] [▼] [◀] [▶] buttons to move the red frame to the group box that you want to skip.

You can't move the frame to a box that does not contain data.

#### 4. Press the [ENTER] button.

The group box selected by the red frame is grayed-out. The grayed-out group box is skipped when the song plays.

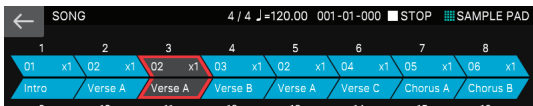

5. To clear the Skip function, move to the red frame and press the [ENTER] button once again.

You can also directly touch a group box in the screen to gray-out (clear) the box.

6. To return to the normal state, repeat steps 2–4.

**MEMO**

The SKIP setting is saved in the scene.

## Editing the Song's Structure (SONG EDIT)

You can use the song edit functions to change the structure of an already-completed song by copying, moving, or deleting selected groups. You can also use various other convenient functions, such as making loop playback settings for specific groups or for the entire song.

### Basic song editing operation

1. Press the [SONG] button.

The SONG screen appears.

2. Select [E2] EDIT.

The SONG EDIT screen appears.

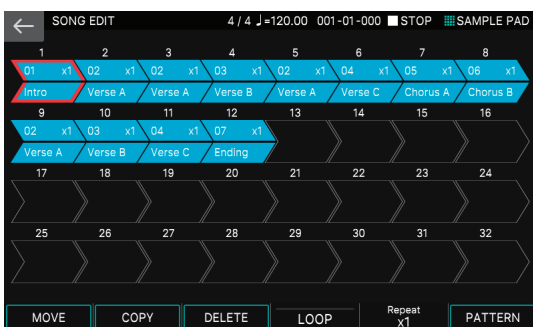

3. Select the pattern to which you want to apply an operation.

The selected group box is enclosed by a red frame. You can select a group by using the cursor [▲] [▼] [◀] [▶] buttons or by directly touching the group box.

4. Use knobs [E1]–[E6] to select the operation that you want to execute.

5. Edit the settings of the menu item you selected.

Menu	Explanation
[E1] MOVE	Moves a group.
[E2] COPY	Copies a group and pastes it at another location.
[E3] DELETE	Deletes a group.
[E4] LOOP	Makes loop playback settings for the entire song.
Repeat [E5] knob	Makes loop playback settings for an individual group.
[E6] PATTERN	Accesses the PATTERN screen.

6. Press the [EXIT] button to return to the SONG screen.

**MEMO**

The changes that you make in song edit are saved in the scene.

### Moving a group (MOVE)

Here's how to move the selected group.

1. In the SONG EDIT screen, select the move-source group, and then select [E1] MOVE.

The SONG EDIT (MOVE) screen appears.

A green ↓ (pointer) appears above the icon of each group box. Use these pointers to specify the move-destination location.

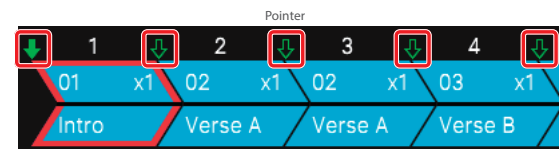

2. Touch the pointer that corresponds to the desired move-destination location.

The pointer changes color to a solid ↓, indicating that the move-destination has been specified.

For example, if you want the "Intro" group located at the first position to move between the third and fourth positions, specify the pointer as shown in the illustration below.

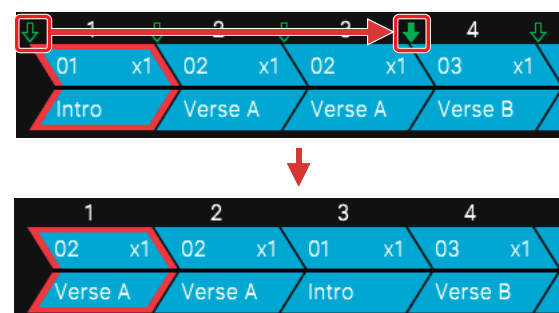

3. Select [E6] EXECUTE.

The selected group is moved, and you return to the SONG EDIT screen.

If you decide to cancel, choose [E1] EXIT.

### Copying a group (COPY)

Here's how to copy the selected group and insert it in a different location. The copy-source group remains in its original location.

1. In the SONG EDIT screen, select the copy-source group, and then select [E2] COPY.

The SONG EDIT (COPY) screen appears.

A green ↓ (pointer) appears above the icon of each group box. Use these pointers to specify the copy-destination location.

2. Touch the pointer that corresponds to the desired copy-destination location.

The pointer changes color to a solid ↓, indicating that the move-destination has been specified.

For example, if you want the "Intro" group located at the first position to be inserted between the second and third positions, specify the pointer as shown in the following illustration.

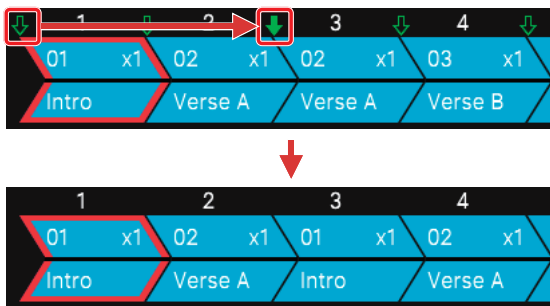

### 3. Select [E6] EXECUTE.

The selected group is copied, and you return to the SONG EDIT screen.

If you decide to cancel, choose [E1] EXIT.

### Deleting a group (DELETE)

Here's how to delete the selected group.

### 1. In the SONG EDIT screen, select the group that you want to delete, and then select [E3] DELETE.

The selected group is deleted.

### Making loop settings for the entire song (LOOP)

Here's how to specify a loop region for the entire song. When song playback enters the loop region, the specified region continues playing as a loop as long as loop is on (or until you stop the song). You can freely change the loop region or turn loop on/off while the song plays.

### 1. In the SONG EDIT screen, select the move-source group, and then select [E4] LOOP.

The SONG EDIT (LOOP) screen appears.

### 2. Set the necessary parameters.

Parameter	Value	Explanation
[E1] EXIT	-	Accesses the SONG EDIT screen.
START [E3] knob	1-32	Specifies the group that will be the beginning of the loop region.
END [E4] knob	1-32	Specifies the group that will be the end of the loop region.
[E6] LOOP SW	OFF, ON	Turns loop playback on/off.

For example, with the settings shown in the following illustration, the groups "Intro" → "Verse A" play, and then playback enters the loop region and continues looping over groups "Verse B" → "Verse C" as long as loop is on.

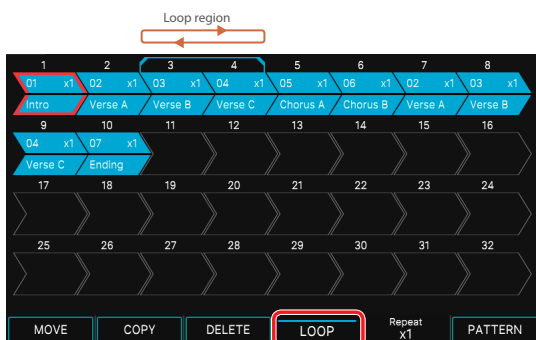

### Making loop settings for an individual group (Repeat)

Separately from the loop settings for the entire song, you can make settings for each group to specify the number of times it will play (Repeat) during song playback.

For example, in a song that has the playback order A → B → C → D, you can leave the song structure unchanged while easily making only the third group "C" play twice, so that the playback occurs as A → B → C → C → D.

The repeat settings for individual groups can be freely changed while the song is playing.

### 1. In the SONG EDIT screen, select the group whose repeat setting you want to change.

### 2. Turn the [E5] knob to specify the number of repeats.

Parameter	Value	Explanation
Repeat [E5] knob	x1-x32	Specifies the number of repeats.

The specified number of repeats is shown in the upper right of each group box icon.

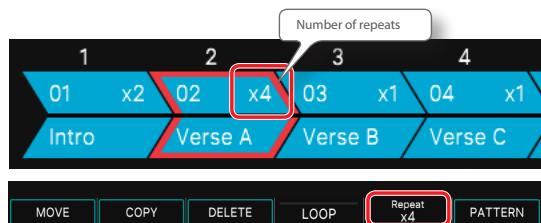

#### MEMO

Loop settings for the entire song can be used together with loop settings for individual groups.

## Adjusting the Pan and Volume Balance

When you've finished creating your patterns and song, adjust the balance and pan as necessary. These adjustments can be made most conveniently in the MIXER screen, where you can adjust the balance between zones while editing the major parameters (p. 58).

## Exporting a Song as SMF (EXPORT)

Here's how the patterns of the song for the currently selected scene can be converted into SMF and exported to a USB flash drive.

### 1. In the SONG screen, select [E6] EXPORT.

The SEQ EXPORT screen appears.

### 2. Proceed with operations in the SEQ EXPORT screen as described in steps 2-14 of "Exporting Patterns as SMF (EXPORT)" (p. 95). In this case, select "SONG" as the source.

### 3. Press the [EXIT] button to return to the SONG screen.

## Saving a Song

The song data that you create is saved together in the current scene. If you want to keep the song you create, save the scene (p. 44).

# 08: Control

## Contents

---

### **Connecting a Computer via USB** ..... 102

- ◇ **Connecting to Your Computer** ..... 102
  - ◇ **USB Driver Settings** ..... 102
  - ◇ **Performing Live with a Plug-In Synthesizer**... 102
  - ◇ **Using USB Audio**..... 102
    - Adjusting the USB Audio Input ..... 102
    - Adjusting the USB Audio Output ..... 102
    - Using the Buttons and Sliders to Make Adjustments ..... 103
- 

### **Controlling an External MIDI Device**

(EXT MIDI OUT) ..... 104

- ◇ **Controlling an External MIDI Device**..... 104
- 

### **Controlling an Analog Synthesizer**

(CV/GATE OUT)..... 105

- ◇ **About the FANTOM's CV/GATE**..... 105
- ◇ **Using CV/GATE**..... 105

# Connecting a Computer via USB

## Connecting to Your Computer

The USB driver is software that transfers data between your computer software and this unit.

You must install the USB driver in order to use this unit connected to your computer.

### MEMO

For details on downloading and installing the USB driver, refer to the Roland website.

<https://www.roland.com/support/>

## USB Driver Settings

Here's how to specify the USB driver that's used when connecting to your computer.

### 1. Press the [MENU] button.



### 2. Touch <SYSTEM>.

### 3. Touch <GENERAL> tab.

### 4. Set the "USB Driver" parameter to "VENDOR."

Parameter	Value	Explanation
USB Driver	VENDOR	Choose this if you want to use a USB driver downloaded from the Roland website.
	GENERIC	Choose this if you want to use the standard USB driver that was included with your computer. * Only MIDI is available.

### 5. Press the [WRITE] button to save the SYSTEM settings.

### 6. Turn this unit's power off, and then on again.

## Performing Live with a Plug-In Synthesizer

You can use the FANTOM to play a plug-in synthesizer that's installed on your computer. In this case, you can route the audio output of your plug-in synthesizer via USB audio into the FANTOM, so that it is heard from the OUTPUT jacks of the FANTOM.

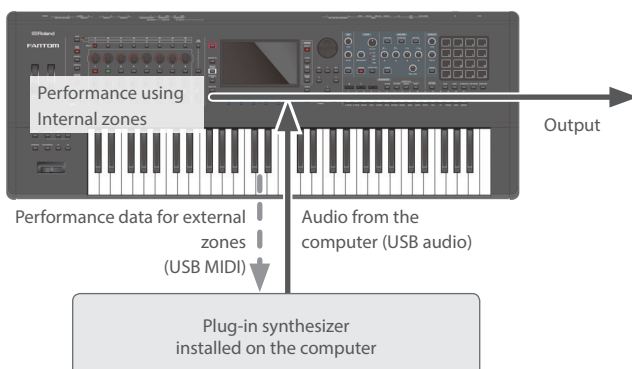

## Using USB Audio

### Adjusting the USB Audio Input

Here's how to make settings for audio that's input from a USB-connected computer.

#### 1. Press the [USB AUDIO SELECT] button.



The SYSTEM screen's USB tab appears

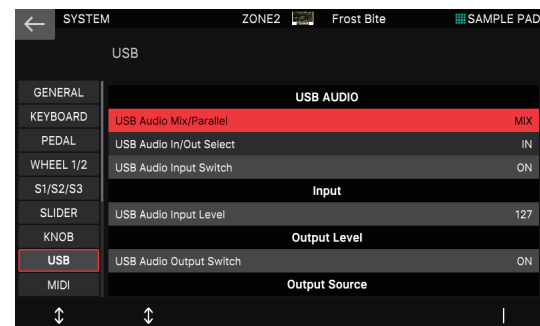

#### 2. Move the cursor to "USB Audio Input Switch," and change the value to "ON."

Audio input from the connected device turns on.

#### 3. Use the cursor to select "USB Audio Input Volume," and adjust the input level.

## Adjusting the USB Audio Output

Here's how to output the FANTOM's audio to a USB-connected computer.

#### 1. Press the [USB AUDIO SELECT] button.

The SYSTEM screen's USB tab appears.

#### 2. Move the cursor to "USB Audio Output Switch" and change the value to "ON."

Audio output to the connected device turns on.

#### 3. Use the cursor to select "USB Audio Output Volume," and adjust the output level.

## Using the Buttons and Sliders to Make Adjustments

In addition to making settings in the SYSTEM screen, you can also use the panel [USB AUDIO IN/OUT] button and the [USB AUDIO] slider to turn USB input/output on/off and to adjust the input/output levels.

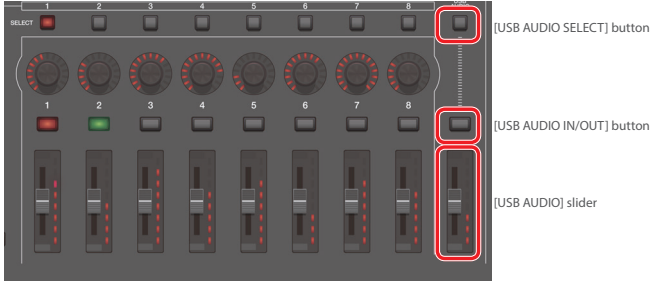

### Adjusting the input level USB Audio In/Out Select=IN

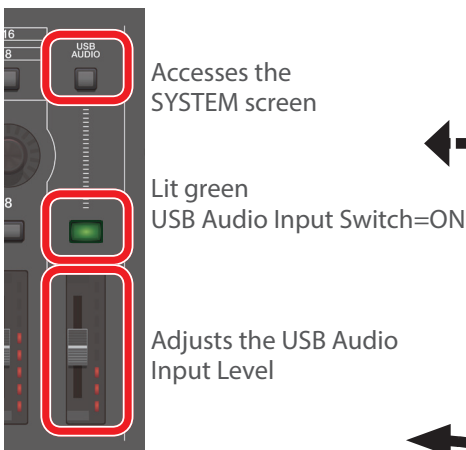

### Adjusting the output level USB Audio In/Out Select=OUT

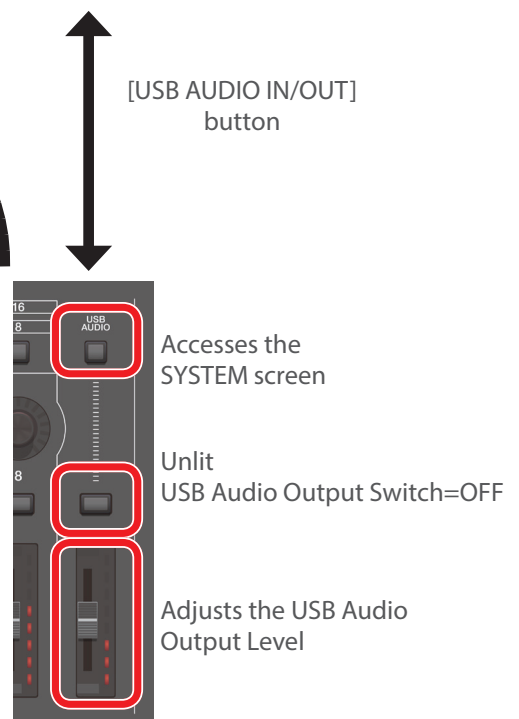
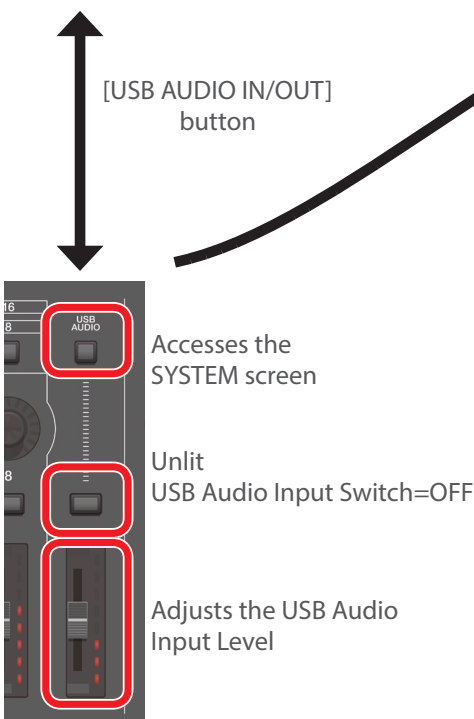
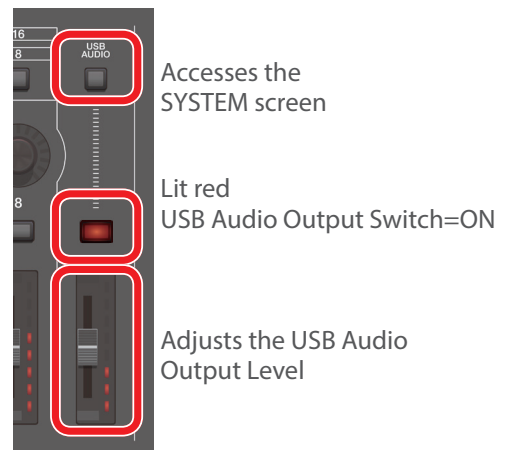

[SHIFT] +  
[USB AUDIO IN/OUT]  
button

[USB AUDIO IN/OUT]  
button

[SHIFT] +  
[USB AUDIO IN/OUT]  
button

[USB AUDIO IN/OUT]  
button

# Controlling an External MIDI Device (EXT MIDI OUT)

## Controlling an External MIDI Device

This unit's knob operations and keyboard performance can be transmitted as MIDI messages from the MIDI OUT connector and from USB MIDI OUT.

Keyboard data can be output from the CV/GATE OUT jacks as CV/GATE signals. By setting a specific zone to "EXT," you can use that zone for controlling an external MIDI device.

### 1. Press the ZONE SELECT button of the zone that you want to use for MIDI output.

To select zones 9–16, use the [ZONE 1-8/9-16] button to switch groups, and then press a ZONE SELECT [1]–[8] button.

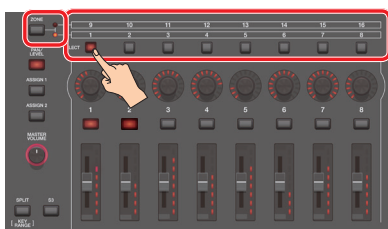

### 2. Press the ZONE INT/EXT button of the selected zone to make it light green.

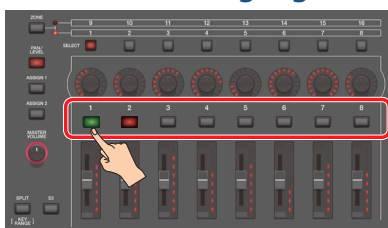

If it's not green, hold down the [SHIFT] button and press the corresponding ZONE INT/EXT button to make it light green (EXT setting).

If it is lit green (EXT setting), MIDI messages are output.

If the ZONE INT/EXT buttons of multiple zones are lit, these settings in conjunction with the zones specified by the ZONE SELECT button (current zone) determine whether MIDI is output to an external sound module (p. 24).

Button status	When the applicable zone is the current zone	When the applicable zone is <b>not the current zone</b>
Unlit (COMMON)	The internal sound engine and the external sound module both produce sound when you play the keyboard.	Neither the internal sound engine nor the external sound module produce sound when you play the keyboard. You can use the internal sequencer or MIDI data from an external device to play the internal sound engine.
Lit red (INT)	The internal sound engine produces sound when you play the keyboard.	Only if the ZONE INT/EXT button of another current zone is on (lit red or green), the internal sound engine produces sound when you play the keyboard.
Lit green (EXT)	The external sound module produces sound when you play the keyboard.	Only if the ZONE INT/EXT button of another current zone is on (lit red or green), the external sound module produces sound when you play the keyboard.
Lit orange (MUTE)	The sound engine is muted. The internal sound engine does not produce sound. If the immediately previous state was lit green, the external sound module produces sound.	

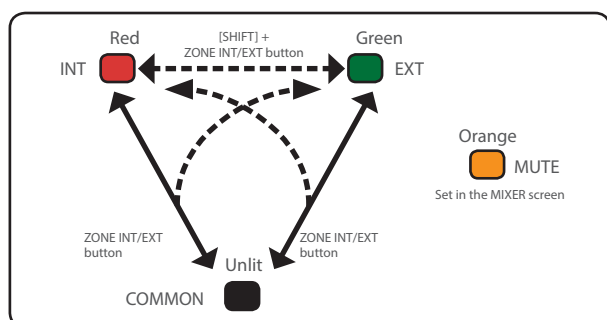

### 3. Press a function select button to select the parameter that you want to operate.

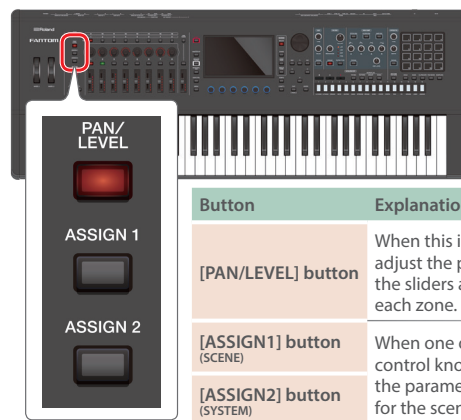

#### Using with PAN/LEVEL

### 4. Press the [PAN/LEVEL] button to make it light.

### 5. Move the control knobs and sliders of zones that are set to "EXT."

Pan or level MIDI messages are output.



When you change the settings of the control knobs or sliders, the edited parameter and its value appear in a popup window.

The popup window closes automatically after a time.

For some parameters, a popup window does not appear.

#### NOTE

When using this function with [PAN/LEVEL], the number of the control knob or slider corresponds to the number of each zone.

#### Using with ASSIGN 1 or ASSIGN 2

### 6. Press the [ASSIGN 1] or [ASSIGN 2] button to make it light.

### 7. Select a zone set to "EXT" as the current zone.

As necessary, specify layering as well.

### 8. Move the control knobs or sliders.

MIDI messages are output according to the assigned function.

#### NOTE

When using this function with [ASSIGN1] or [ASSIGN2], operating a control knob or slider will output MIDI to the EXT zone that outputs keyboard playing. (If layer settings are used, MIDI is output to multiple zones.) You are free to create layers that combine INT zones and EXT zones. In this case, the keyboard and controllers will simultaneously control the internal sound engine and the external sound module. If layer settings are not used, MIDI is output for the current zone.

#### MEMO

- ASSIGN 1 is assigned functions individually for each scene. ASSIGN 2 is assigned functions for the entire system.
- By holding down the [SHIFT] button and pressing the [ASSIGN 1] or [ASSIGN 2] button, you can access the edit screen for assigning parameters or functions. For details, refer to "Parameter Guide" (PDF) or "System Parameters" (p. 112).
- You can make detailed settings in ZONE EDIT (p. 43).
- The settings that you make are saved as scene settings (p. 44).



# Controlling an Analog Synthesizer (CV/GATE OUT)

## About the FANTOM's CV/GATE

The FANTOM is equipped with two sets of CV/GATE output jacks, and by connecting these to analog synthesizers that are equipped with CV/GATE input jacks, you can control their note on/off and pitch.

### About CV/GATE signals

CV stands for "Control Voltage," and is an electrical signal (control voltage) used to control the behavior of an analog synth or Eurorack module. GATE is a signal used to control the beginning and end of an envelope.

Jack	Explanation
GATE OUT 1 jack GATE OUT 2 jack	These jacks output note on/off. Outputs +5 V.
CV OUT 1 jack CV OUT 2 jack	These jacks output pitch. If you've made transpose or octave shift settings, this voltage changes accordingly. These jacks support OCT/V (it does not support Hz/V).

Normally, the CV OUT 1 jack and the GATE OUT 1 jack are used as a pair. Likewise, the CV OUT 2 jack and the GATE OUT 2 jack are used as a pair.

### MEMO

By making a system setting, GATE OUT 2 can be changed to CV OUT (CV3). For details, refer to "System Parameters" (p. 112).

## Using CV/GATE

Here's how to use CV/GATE to control an analog synthesizer. In the same way as for "Controlling an External MIDI Device (EXT MIDI OUT)," the analog synthesizer is controlled from an EXT zone using CV/GATE.

Here we explain an example in which we connect the CV OUT 1 jack and GATE OUT 1 jack to an analog synthesizer, and control it from zone 1.

1. Connect the CV OUT 1 jack and the GATE OUT 1 jack to the analog synthesizer's CV IN jack and GATE IN jack respectively.

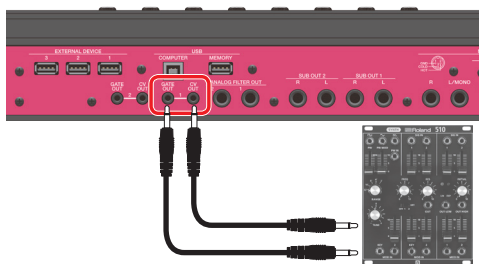

### NOTE

Depending on the manufacturer or model, the CV jack and GATE jack might be named differently. For details, refer to the owner's manual of your analog synthesizer.

2. Press the [MENU] button.
3. Touch <SYSTEM>.
4. Touch <CV/GATE> tab.
5. Set the CV/Gate Assign Source value to "SCENE."

The SYSTEM screen appears.

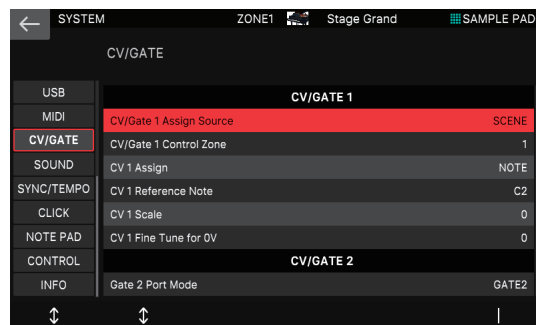

Now the control settings for CV/Gate 1 (CV OUT 1 jack and GATE OUT 1 jack) can be set individually for each scene.

Save the system parameters as necessary.

6. Press the [MENU] button.
7. Touch <SCENE EDIT>.
8. Touch <CV/GATE> tab.

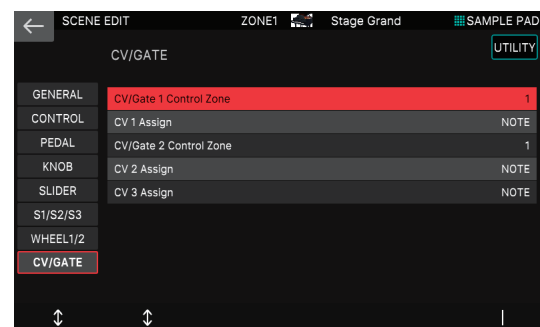

9. Set the CV/Gate 1 Control Zone to "1."
10. Make zone 1 the current zone.
11. Press the ZONE INT/EXT button of zone 1 so that it is lit green.

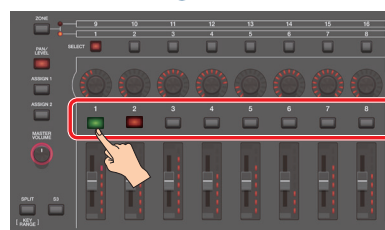

Zone 1 is now an EXT zone

If the button is not lit green, hold down the [SHIFT] button and pressing corresponding ZONE INT/EXT button so that it is lit green (EXT setting).

When this is lit green (EXT setting), CV/Gate signals are output.

When the ZONE INT/EXT buttons of multiple zones are lit, the situation is the same as for EXT MIDI OUT; the combination of zones specified by the ZONE SELECT buttons (the current zone) determines whether CV/Gate signals are output to the external sound module.

12. When you play the keyboard, CV/Gate signals are output, controlling the analog synthesizer.

### MEMO

If you want to keep the settings, save the scene. In this example, the scene parameters are used to make CV/Gate 1 control settings, so you can use this to control an analog synthesizer only in specific scenes.

## Memo

# 09: Settings

## Contents

<b>Convenient Functions (Utility)</b> .....	<b>108</b>
◇ Basic Utility Operations.....	<b>108</b>
◇ Backing Up User Data to a USB Flash Drive (BACKUP).....	<b>108</b>
◇ Restoring Backup Data into the FANTOM (RESTORE).....	<b>108</b>
◇ Formatting a USB Flash Drive (USB MEMORY FORMAT).....	<b>109</b>
◇ Returning to the Factory Settings (Factory Reset) .	<b>109</b>
◇ Returning the Contents of Internal Storage to the Factory Settings (Internal Storage Initialize).....	<b>109</b>

<b>Convenient Functions (File Utility)</b> .....	<b>110</b>
◇ Regarding Folder Structure.....	<b>110</b>
◇ Basic Procedure for File Utilities.....	<b>110</b>
◇ Renaming a File or Folder (RENAME).....	<b>110</b>
◇ Deleting a File or Folder (DELETE).....	<b>110</b>
◇ Copying a File or Folder (COPY).....	<b>110</b>
◇ Moving a File or Folder (MOVE).....	<b>111</b>
◇ Creating a New Folder (CREATE FOLDER).....	<b>111</b>

<b>Settings for the Entire FANTOM</b> .....	<b>112</b>
◇ Basic Procedure for System Settings.....	<b>112</b>
◇ Saving the System Settings.....	<b>112</b>
◇ System Parameter.....	<b>112</b>
Overall Settings (GENERAL).....	<b>112</b>
Keyboard Settings (KEYBOARD).....	<b>113</b>
Pedal Settings (PEDAL).....	<b>113</b>
Wheel Settings (WHEEL 1/2).....	<b>114</b>
S1/S2/S3 Settings (S1/S2/S3).....	<b>114</b>
Slider Settings (SLIDER).....	<b>114</b>
Knob Settings (KNOB).....	<b>114</b>
USB Audio Settings (USB AUDIO).....	<b>115</b>
MIDI Settings (MIDI).....	<b>115</b>
CV/GATE Settings (CV/GATE).....	<b>116</b>
Sound Settings (SOUND).....	<b>116</b>
Synchronization Settings (SYNC/TEMPO).....	<b>117</b>
Click Settings (CLICK).....	<b>117</b>
Note Pad Settings (NOTE PAD).....	<b>117</b>
Control Function Settings (CONTROL).....	<b>117</b>
Information About the FANTOM Itself (INFO).....	<b>117</b>

# Convenient Functions (Utility)

## Basic Utility Operations

### 1. Press the [MENU] button.

The MENU screen appears.

### 2. Touch <UTILITY>.

The UTILITY screen appears.

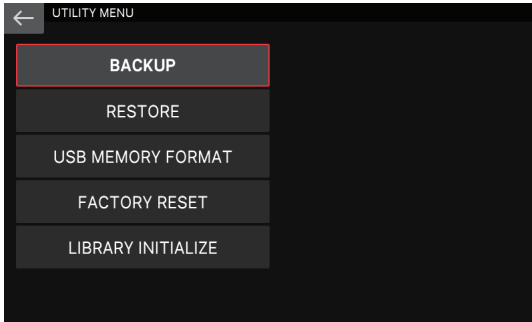

### 3. In the screen, touch the desired menu item.

### 4. Edit the settings for the menu item you selected.

Menu	Explanation
BACKUP	Backs-up user data and system data to a USB flash drive.
RESTORE	Restores backed-up data into the FANTOM.
USB MEMORY FORMAT	Initializes a USB flash drive.
FACTORY RESET	Restores the factory settings.
INTERNAL STORAGE INITIALIZE	Returns the contents of internal storage to the factory-set state.

## Backing Up User Data to a USB Flash Drive (BACKUP)

Here's how you can back up all settings stored in the FANTOM to a USB flash drive.

The following settings are backed up.

- User memory settings (e.g., scenes, user tones, user rhythm groups)
- System memory settings

#### NOTE

If you back up using the same file name as existing backup data on the USB flash drive, that data is overwritten. If you want to make a new backup, assign a different name.

### 1. In the UTILITY screen, touch <BACKUP>.

The BACKUP screen appears.

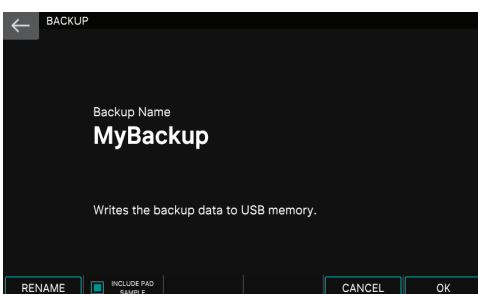

### 2. If you want the samples assigned to the pads to be included in the backup, select the [E2] INCLUDE PAD SAMPLE check box.

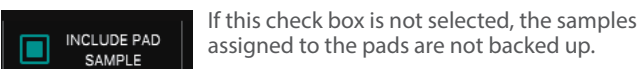

### 3. If you want to rename the file that will be backed up, select [E1] RENAME and assign a name (p. 13).

By default, the file name is "MyBackup."

When you have edited the name, select [E6] OK to close the window.

### 4. Select [E6] OK.

A confirmation message appears.

If you decide to cancel, choose [E6] CANCEL.

### 5. To execute, select [E5] OK.

#### NOTE

Never turn off the power or remove the USB flash drives while the screen indicates "working."

### 6. Select [E6] CLOSE to return to the SCENE SELECT screen.

## Restoring Backup Data into the FANTOM (RESTORE)

Here's how to restore backup data into the FANTOM.

#### NOTE

When you execute the restore operation, all settings currently saved in the FANTOM will disappear. If you want to keep the current settings, back them up using a different name.

### 1. In the UTILITY screen, touch <RESTORE>.

The RESTORE screen appears.

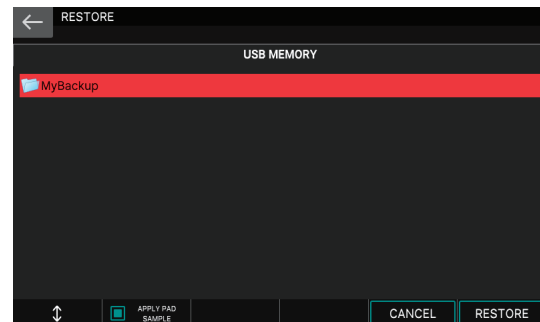

### 2. Touch the file that you want to restore.

### 3. If you also want to restore the samples that are assigned to the pads, select the [E2] APPLY PAD SAMPLE check box.

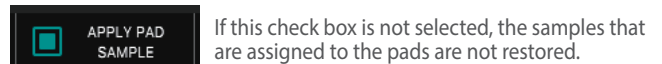

### 4. Select [E6] RESTORE.

A confirmation message appears.

If you decide to cancel, choose [E6] CANCEL.

#### NOTE

If the "APPLY PAD SAMPLE" check box is selected, an estimate of the required time is shown in the confirmation screen. This estimated time is approximate, and will not necessarily be precise. The actual time will vary depending on the USB flash drive that you use and on the state of internal memory.

### 5. To execute, select [E5] OK.

#### NOTE

Never turn off the power or remove the USB flash drives while the screen indicates "working."

### 6. When the message "Completed. Please Power Off!" appears, turn the power off and then on again (p. 20).

## Formatting a USB Flash Drive (USB MEMORY FORMAT)

Here's how to format (initialize) a USB flash drive.

**NOTE**

- Before using a USB flash drive with the FANTOM, you must use this function to format it.
- Use a commercially available USB flash drive. However, we cannot guarantee that all commercially available USB flash drives will work.

**1. In the UTILITY screen, touch <USB MEMORY FORMAT>.**

The USB MEMORY FORMAT screen appears.

**2. Select [E6] OK.**

A confirmation message appears.  
If you decide to cancel, choose [E6] CANCEL.

**3. To execute, select [E5] OK.**

**NOTE**

Never turn off the power or remove the USB flash drives while the screen indicates "working."

## Returning to the Factory Settings (Factory Reset)

Here's how you can restore this unit's settings to their factory-set condition (factory reset).

**NOTE**

When you execute the Factory Reset operation, all data in this unit will be lost. If there is any data that you want to keep, back it up to an USB flash drive.

**1. In the UTILITY screen, touch <FACTORY RESET>.**

The FACTORY RESET screen appears.

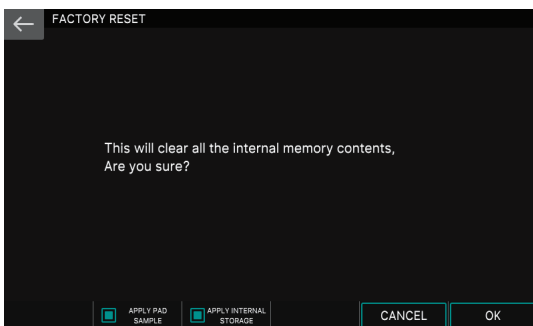

**2. If you want the sample data assigned to the pads to also be reset to the factory settings, select the [E2] APPLY FACTORY SAMPLE check box.**

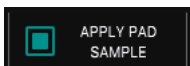

If this check box is not selected, the sample data is preserved without change.

**3. If you want the contents of internal storage to also be reset to the factory settings, select the [E3] APPLY INT STORAGE check box.**

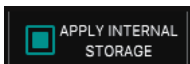

If this check box is not selected, the contents of internal storage are preserved without change.

**4. Select [E6] OK.**

A confirmation message appears.  
If you decide to cancel, choose [E6] CANCEL.

**5. To execute, select [E5] OK.**

**NOTE**

Never turn off the power while the factory reset is in progress.

## Returning the Contents of Internal Storage to the Factory Settings (Internal Storage Initialize)

Here's how you can return the contents of internal storage to the factory-set condition (internal storage initialize).

**NOTE**

If internal storage contains data that you yourself sampled, all of this data will be lost when you execute this internal storage initialize command. If you want to keep this data, use the file utility function to manually back up this data to a USB flash drive.

**1. In the UTILITY screen, touch <INTERNAL STORAGE INITIALIZE>.**

The INTERNAL STORAGE INITIALIZE screen appears.

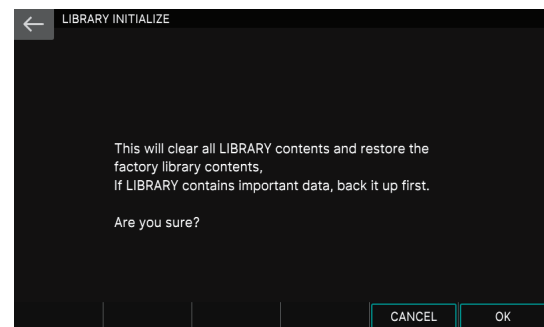

**2. Select [E6] OK.**

A confirmation message appears.  
If you decide to cancel, choose [E6] CANCEL.

**3. To execute, select [E5] OK.**

**NOTE**

Never turn off the power while initialization is in progress.

### The folder structure of a USB flash drive

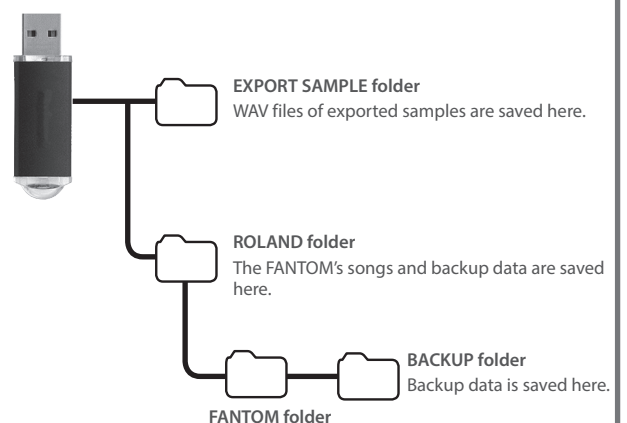

# Convenient Functions (File Utility)

## Regarding Folder Structure

These functions let you copy, delete, or move files that are saved in internal storage or a USB flash drive.

For details on the folder structure of a USB flash drive, and the data that is saved in the various folders, refer to “The folder structure of a USB flash drive” (p. 109).

### NOTE

- The file utilities cannot handle files or folders that contain the following characters.  
“\* , / ; : < > ? \ | ~”  
Nor can special characters such as double-byte characters be handled.
- Take care not to inadvertently delete important data.
- Do not modify the folder names that are listed in “The folder structure of a USB flash drive.”
- Note that if you modify a file name’s extension (the portion such as .wav), functions such as import will no longer recognize the files.

## Basic Procedure for File Utilities

### 1. Press the [MENU] button.

The MENU screen appears.

### 2. Touch <FILE UTILITY>.

The FILE UTILITY screen appears.

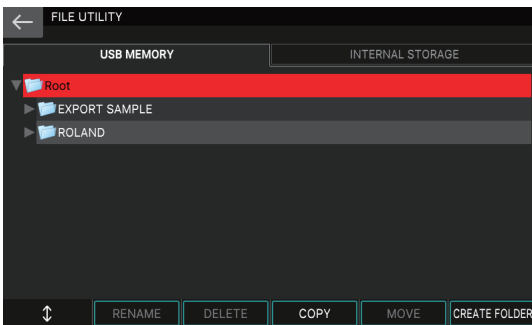

### 3. Touch a tab in the upper part of the screen to select USB flash drive or internal storage.

### 4. Select the file or folder for which you want to execute an operation.

The selected file or folder is highlighted.  
You can use the following operations when selecting a file or folder.

Operation	Explanation
Touching a file or folder name in the screen	Directly selects the file or folder that you touch. By holding down the [SHIFT] button and performing this operation, you can select multiple files or folders.
[E1] knob [▲] button [▼] button	Scroll up/down to select a file or folder. By holding down the [SHIFT] button and performing this operation, you can select multiple files or folders.
[ENTER] button	Expands the contents of a folder. Press once again to collapse the expanded contents.
[▶] button	Expands the contents of a folder to make it visible.
[◀] button	Collapses the expanded contents
[EXIT] button	Returns to the previous screen.

### 5. Use knobs [E2]–[E6] to select the operation that you want to execute.

### 6. Change the settings as appropriate for the selected menu item.

Menu	Explanation
[E2] RENAME	Renames a file or folder.
[E3] DELETE	Deletes a file or folder.
[E4] COPY	Copies a file or folder.
[E5] MOVE	Moves a file or folder.
[E6] CREATE FOLDER	Creates a new folder.

## Renaming a File or Folder (RENAME)

Here’s how to rename a file or folder.

### 1. In the FILE UTILITY screen, select the file or folder that you want to rename, and then execute [E2] RENAME.

The RENAME screen appears.

### 2. As described in the explanation of the RENAME screen, rename the file or folder (p. 13).

### 3. Select [E6] OK.

If you decide to cancel, choose [E5] CANCEL.

### NOTE

Never turn off the power or remove the USB flash drives while the screen indicates “working.”

## Deleting a File or Folder (DELETE)

Here’s how to delete an unwanted file or folder.

### 1. In the FILE UTILITY screen, select file or folder that you want to delete, and then execute [E3] DELETE.

A confirmation message appears.

### 2. Select [E5] OK.

If you decide to cancel, choose [E6] CANCEL.

### NOTE

Never turn off the power or remove the USB flash drives while the screen indicates “working.”

## Copying a File or Folder (COPY)

Here’s how to copy a file or folder to another location.

### 1. In the FILE UTILITY screen, select the copy-source file or folder and then execute [E4] COPY.

The FILE UTILITY (COPY DESTINATION) screen appears.

### 2. Touch the copy-destination folder to select it.

The selected folder is highlighted.

### 3. Select [E6] SELECT.

The copy is executed.

### NOTE

Never turn off the power or remove the USB flash drives while the screen indicates “working.”

## Moving a File or Folder (MOVE)

Here's how to move a file or folder to a different location.

1. **In the FILE UTILITY screen, select the move-source file or folder, and then execute [E5] MOVE.**

The FILE UTILITY (MOVE DESTINATION) screen appears.

2. **Touch the move-destination folder to select it.**

The selected folder is highlighted.

3. **Select [E6] SELECT.**

The move is executed.

### NOTE

Never turn off the power or remove the USB flash drives while the screen indicates "working."

## Creating a New Folder (CREATE FOLDER)

Here's how to create a new folder.

1. **In the FILE UTILITY screen, select the folder of the level in which you want to create the new folder, and execute [E6] CREATE FOLDER.**

The RENAME screen appears.

### MEMO

You can also create additional folders inside a folder.

2. **As described in the explanation of the RENAME screen, rename the folder (p. 13).**

3. **Select [E6] OK.**

If you decide to cancel, choose [E5] CANCEL.

### NOTE

Never turn off the power or remove the USB flash drives while the screen indicates "working."

# Settings for the Entire FANTOM

## Basic Procedure for System Settings

### 1. Press the [MENU] button.

The MENU screen appears.

### 2. Touch <SYSTEM>.

The SYSTEM screen appears.

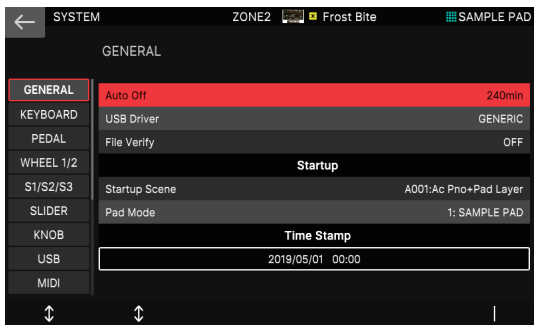

Menu	Explanation
[E1] knob	Scrolls up or down through the tabs.
[E2] knob	Scrolls the cursor up or down.
[E6] knob	Edits the value of the parameter selected by the cursor.

### 3. Switch between the tabs in the left side of the screen to select the desired screen.

### 4. Select the desired parameter, and change its value.

Tab	Explanation
GENERAL	Specifies overall settings.
KEYBOARD	Specifies keyboard settings.
PEDAL	Specifies pedal settings.
WHEEL 1/2	Specifies wheel settings.
S1/S2/S3	Specifies [S1], [S2], and [S3] button settings.
SLIDER	Specifies slider settings.
KNOB	Specifies knob settings.
USB	Specifies USB settings.
MIDI	Specifies MIDI settings.
CV/GATE	Specifies CV/GATE settings.
SOUND	Specifies settings related to sound.
SYNC/TEMPO	Specifies synchronization and tempo settings.
CLICK	Specifies click tone settings.
NOTE PAD	Specifies note pad settings.
CONTROL	Specifies settings related to control functions.
INFO	Shows information about this unit.

## Saving the System Settings

If you want to save the system settings that you changed, execute the Save operation.

### 1. In the SYSTEM screen, press the [WRITE] button.

When the save is completed the indication "Completed" appears.

## System Parameter

### Overall Settings (GENERAL)

Parameter	Value	Explanation
Auto Off	OFF, 30, 240	Specifies whether the unit will turn off automatically after a certain time has elapsed. If you don't want the unit to turn off automatically, choose "OFF" setting.
USB Driver	VENDOR	The dedicated USB driver is used.
	GENERIC	The generic driver provided by the operating system is used.
File Verify	OFF, ON	Verifies the correctness of the file when copying or backing-up. This provides higher reliability, but requires more time to execute.
<b>Startup</b>		
Startup Scene	A001–D128	Selects the scene that is loaded when the power is turned on.
Pad Mode	(p. 74)	Specifies the pad mode when the power is turned on.
<b>Time Stamp</b>		
Year/Month/Day/Hour/Minute	-	The date and time that you specify here is used as the timestamp for files created by the FANTOM.

### Setting the date and time

#### 1. Move the cursor to the date and time fields at the bottom of the screen.

#### 2. Press the [ENTER] button.

The Time Stamp window appears.

#### 3. Use the [E1]–[E5] knobs to specify the date and time.

#### 4. Select [E6] CLOSE.

#### 5. After changing the date and time, save the system settings, and then turn the power off and on again.



## Keyboard Settings (KEYBOARD)

Parameter	Value	Explanation
Keyboard Velocity		Specifies the velocity transmitted when a key is played.
	REAL	The transmitted velocity value will correspond to the force with which you strike the key.
	1–127	The transmitted velocity value will be fixed, regardless of the force with which you strike the key.
Keyboard Velocity Curve	LIGHT	The keyboard will have a lighter-feeling touch. Since you'll be able to reach fortissimo (ff) without having to play as strongly as with the "MEDIUM" setting, the keyboard will feel lighter. This setting makes it easier for people with reduced finger strength to play the keyboard.
	MEDIUM	This is the standard keyboard touch setting.
	HEAVY	The key will have a heavier-feeling touch. Since you'll need to play more strongly than with the "MEDIUM" setting in order to reach fortissimo (ff), the keyboard will feel heavier. This setting allows you to use your playing dynamics to add more expression to your performances.
Keyboard Velocity Curve Offset	-10+9	Adjusts the keyboard velocity curve. Lower values make the keyboard feel lighter. Higher values make the keyboard feel heavier.
Hi-Res Velocity Out	OFF, ON	Specifies whether high-resolution velocity data is transmitted.
Aftertouch Sens	0–100	Specifies the aftertouch sensitivity. Higher settings make it easier to apply aftertouch. Normally you will leave this at 100.
<b>Arpeggio</b>		
Arpeggio Trigger Quantize		Specifies how arpeggios will be triggered.
	OFF	The arpeggio starts the moment you play the keyboard.
	BEAT	If you play the keyboard while the sequencer or a rhythm pattern is playing, the arpeggio automatically starts at the beginning of the beat.
	MEAS	If you play the keyboard while the sequencer or a rhythm pattern is playing, the arpeggio automatically starts at the beginning of the measure.
Arpeggio Switch Mode	OFF/ON	The ARPEGGIO screen does not appear when you operate the [ARPEGGIO] button to change from OFF to ON.
	OFF/ON & ARP SCREEN	The ARPEGGIO screen appears when you operate the [ARPEGGIO] button to change from OFF to ON.
Chord Memory Switch Mode	OFF/ON	The CHORD MEMORY screen does not appear when you operate the [CHORD MEMORY] button to change from OFF to ON.
	OFF/ON & CHD SCREEN	The CHORD MEMORY screen appears when you operate the [CHORD MEMORY] button to change from OFF to ON.

## Pedal Settings (PEDAL)

Parameter	Value	Explanation
Pedal Assign Source	SYS, SCENE	Specifies whether the functions controlled by pedals connected to the PEDAL CTRL 1, 2/L, 3/C jack are determined by the system settings (SYS) or by the settings of the scene (SCENE).
<b>Control Pedal</b>		
Pedal1–3 Polarity	STANDARD, REVERSE	Selects the polarity of the pedal connected to the PEDAL CTRL 1, CTRL 2/L, and CTRL 3/C jacks. Depending on the model of pedal, the result of depressing or releasing the pedal might be the opposite of what you expect. If so, choose the "REVERSE" setting. If you're using a Roland pedal (that has no polarity switch), choose the "STANDARD" setting.
Pedal1–3 Assign		Specify the functions that are controlled by pedals connected to the PEDAL CTRL 1, 2/L, 3/C jacks.
	OFF	No function is assigned.
	CC01–31, 33–95	Controller number 1–31, 33–95
	BEND DOWN	The same effect as moving the pitch bend lever to the left.
	BEND UP	The same effect as moving the pitch bend lever to the right.
	AFT	Aftertouch
	START/STOP	Start/stop the sequencer.
	TAP TEMPO	The same effect as pressing the panel [TAP] button.
	SCENE DOWN	Switch the scene to the previous number. When using a scene chain, switch to the previous number in the chain set.
	SCENE UP	Switch the scene to the next number. When using a scene chain, switch to the next number in the chain set.
Pedal1–3 Range Min	OCT DOWN	The same effect as pressing the panel OCTAVE [DOWN] button.
	OCT UP	The same effect as pressing the panel OCTAVE [UP] button.
	ARPEGGIO SW	The same effect as pressing the panel [ARPEGGIO] button.
	CHORD MEM SW	The same effect as pressing the panel [CHORD MEMORY] button.
Pedal1–3 Range Max	DEC	The same effect as pressing the panel [DEC] button.
	INC	The same effect as pressing the panel [INC] button.
<b>Hold Pedal</b>		
Hold Pedal Polarity	STANDARD, REVERSE	Selects the polarity of the pedal connected to the PEDAL HOLD/R jack. Depending on the model of pedal, the result of depressing or releasing the pedal might be the opposite of what you expect. If so, choose the "REVERSE" setting. If you're using a Roland pedal (that has no polarity switch), choose the "STANDARD" setting.
Continuous Hold Pedal	OFF, ON	If this is ON, the PEDAL HOLD/R jack will support half-pedaling. If half-pedaling is enabled, you can connect a damper pedal (such as the DP-10; available separately) and use the pedal to control subtle nuances of the piano sounds you play.

## Wheel Settings (WHEEL 1/2)

Parameter	Value	Explanation
Wheel Assign Source	SYS, SCENE	Specifies whether the functions controlled by the wheels are determined by the system settings (SYS) or by the settings of the scene (SCENE).
<b>Assignable</b>		
Wheel1-2 Assign	Assign the functions controlled by the wheels.	
	OFF	No function is assigned.
	CC01-31, 33-95	Controller number 1-31, 33-95
	BEND	The same effect as moving the pitch bend lever.
	AFT	Aftertouch
Wheel1-2 Range Min	0-127	Specify the lower limit value for the range of the assigned function.
Wheel1-2 Range Max	0-127	Specify the upper limit value for the range of the assigned function.

## S1/S2/S3 Settings (S1/S2/S3)

Parameter	Value	Explanation	
S1-S3 Assign Source	SYS, SCENE	Specifies whether the functions controlled by the [S1], [S2], and [S3] buttons are determined by the system settings (SYS) or by the settings of the scene (SCENE).	
<b>Assignable</b>			
S1-3 Switch Assign	Assign the functions controlled by the [S1], [S2], and [S3] buttons.		
	OFF	No function is assigned.	
	CC01-31, 33-95	Controller number 1-31, 33-95	
	BEND DOWN	The same effect as moving the pitch bend lever to the left.	
	BEND UP	The same effect as moving the pitch bend lever to the right.	
	AFT	Aftertouch	
	MONO/POLY	Mono/poly switch is assigned.	
	MFX SW	MFX on/off is assigned.	
	EQ SW	EQ on/off is assigned.	
	IFX1 SW	IFX1 on/off is assigned.	
	IFX2 SW	IFX2 on/off is assigned.	
	CHORUS SW	CHORUS on/off is assigned.	
	REVERB SW	REVERB on/off is assigned.	
	MASTER COMP SW	MASTER COMP on/off is assigned.	
	MASTER EQ SW	MASTER EQ on/off is assigned.	
	S1-3 Switch Mode	Specify the behavior of the buttons.	
		MOMENTARY	The assigned effect is applied only while you hold down the button.
LATCH		The effect is switched each time you press the button.	

## Slider Settings (SLIDER)

Parameter	Value	Explanation
Slider Mode	DIRECT, CATCH	Specifies whether control data of the corresponding position is always output when you move a slider (DIRECT) or control data is output only after the slider position passes through the current value of the parameter (CATCH).
<b>Assignable</b>		
Slider1-8 Assign	Assigns the function controlled by the sliders.	
	OFF	No function is assigned.
	CC01-31, 33-95	Controller number 1-31, 33-95
	BEND	The same effect as moving the pitch bend lever.
	AFT	Aftertouch
Slider1-8 Range Min	0-127	Specify the lower limit value for the range of the assigned function.
Slider1-8 Range Max	0-127	Specify the upper limit value for the range of the assigned function.

## Knob Settings (KNOB)

Parameter	Value	Explanation
<b>Assignable</b>		
Knob1-8 Assign	Assigns the function controlled by the control knobs.	
	OFF	No function is assigned.
	CC01-31, 33-95	Controller number 1-31, 33-95
	BEND	The same effect as moving the pitch bend lever.
Knob1-8 Range Min	AFT	Aftertouch
	0-127	Specify the lower limit value for the range of the assigned function.
Knob1-8 Range Max	0-127	Specify the upper limit value for the range of the assigned function.

## USB Audio Settings (USB AUDIO)

Parameter	Value	Explanation
USB Audio Mix/Parallel	MIX	All audio signals output from the FANTOM are mixed to channels 1–2. This is convenient for stereo recording. Other channels are output according to their settings.
	PARALLEL	The audio signals output from the FANTOM are output individually from all channels. This is convenient for simultaneous multi-channel recording.
USB Audio In/Out Select	IN, OUT	Specifies whether the [USB AUDIO] slider adjusts the USB audio input level (IN) or output level (OUT).
USB Audio Input Switch	OFF, ON	Specifies whether audio from a computer or other device connected to the USB COMPUTER port is input to the FANTOM (ON) or is not input (OFF).
<b>Input</b>		
USB Audio Input Level	0–127	Adjusts the USB audio input level.
<b>Output Level</b>		
USB Audio Output Switch	OFF, ON	Specifies whether audio from the FANTOM is output to a computer or other device connected to the USB COMPUTER port (ON) or is not output (OFF).
<b>Output Source</b>		
USB Audio Output Level	0–127	Adjusts the USB audio output level.

## MIDI Settings (MIDI)

Parameter	Value	Explanation
Device ID	17–32	When transmitting and receiving system exclusive messages, the device ID numbers of both devices must match.
Scene Control Channel	1–16, OFF	Specifies the MIDI channel for controlling the scene.
USB-MIDI Thru	OFF, ON	Specifies whether MIDI messages received via the USB COMPUTER port/MIDI IN connector will be re-transmitted from the MIDI OUT 2 connector/USB COMPUTER port (ON) or not be re-transmitted (OFF).
MIDI OUT2 Port Mode	OUT	Selects the function of the FANTOM's MIDI THRU/OUT 2 connector. Operates as a MIDI OUT connector, transmitting keyboard and controller messages to an external MIDI device.
	THRU	Operates as a MIDI THRU connector, from which MIDI messages received at the MIDI IN connector are retransmitted without change to an external device. Performance data from the FANTOM will no longer be transmitted from this connector.
<b>Transmit</b>		
Transmit Active Sensing	OFF, ON	Specifies whether active sensing messages will be transmitted (ON) or not be transmitted (OFF).
Transmit Edit Data	OFF, ON	Specifies whether changes in the scene settings are transmitted as system exclusive messages (ON) or not transmitted (OFF).
<b>Receive</b>		
Receive Program Change	OFF, ON	Specifies whether program change messages will be received (ON) or not be received (OFF).
Receive Bank Select	OFF, ON	Specifies whether bank select messages will be received (ON) or not be received (OFF).

Parameter	Value	Explanation
Receive Exclusive	OFF, ON	Specifies whether system exclusive messages will be received (ON) or not be received (OFF).

### What is a MIDI?

MIDI (Musical Instrument Digital Interface) is a standard specification that allows musical data to be transferred between electronic musical instruments and computers. If a MIDI cable is connected between devices equipped with MIDI connectors, you'll be able to play multiple devices from a single MIDI keyboard, perform ensembles using multiple MIDI instruments, program the settings to change automatically as the song progresses, and more.

### About MIDI connectors

The FANTOM is equipped with the following two types of MIDI connectors, each of which has the following role.

Connector	Explanation
MIDI IN connector	This connector receives MIDI messages that are sent from an external MIDI device. When the FA receives MIDI messages, it can respond by playing notes, switching sounds, etc.
MIDI OUT connector	This connector transmits MIDI messages to an external MIDI device. Use it when you want to control an external MIDI device.

### MIDI signal flow

USB-MIDI Thru=OFF

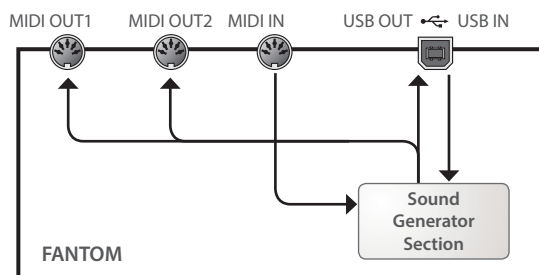

USB-MIDI Thru=ON

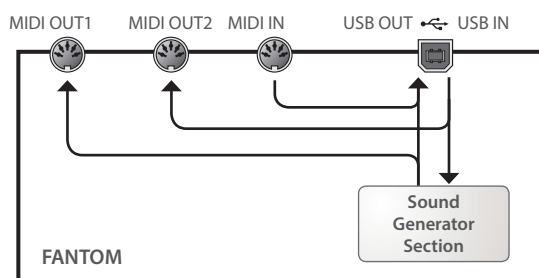

## CV/GATE Settings (CV/GATE)

Parameter	Value	Explanation
<b>CV/GATE 1, CV/GATE 2</b>		
CV/Gate 1-2 Assign Source	SYS, SCENE	Specifies whether CV/GATE settings are determined by the system settings (SYS) or by the settings of the scene (SCENE).
CV/Gate 1-2 Control Zone	1-16, OFF	Specifies the zones whose notes are output to the CV OUT 1/2 and GATE OUT 1/2 jacks.
CV 1-2 Assign	NOTE, CC01-31, 33-95, BEND, AFT, VELO	Specifies the MIDI messages that are used to control CV OUT.
CV 1-2 Reference Note	C0-C4	Specifies the note number for which CV OUT is at 0 V, in units of an octave.
CV 1-2 Scale	-63+63	Adjusts the CV scale.
CV 1-2 Fine Tune for 0V	-50+50	Adjusts the 0 V setting for CV OUT. *If you change the Scale value, this value also changes slightly.
<b>CV/GATE only</b>		
Gate 2 Port Mode	GATE2	The GATE OUT 2 jack is used as a gate jack, as usual.
	CV3	The GATE OUT 2 jack is used as a third CV OUT.
CV 3 Assign	NOTE, CC01-31, 33-95, BEND, AFT, VELO	Specifies the MIDI messages used to control CV OUT.

## Sound Settings (SOUND)

Parameter	Value	Explanation
Local Switch	OFF, ON	Enables or disables the connection between the controller section (keyboard, pitch bend/modulation lever, panel knobs and buttons, pedals, etc.) and the internal sound generator. Normally you should leave this "ON." If you want operations on the FANTOM to control only an external sound module, turn this "OFF."
Tone Remain Sw	OFF, ON	Specifies whether the currently-heard sound is held when you select another sound (ON) or not held (OFF). * Even if this is "ON," the effect sound might not be held in some cases.
Master Tune	415.3-466.2 [Hz]	Sets the FANTOM's overall tuning (the frequency of the A4 key).
Master Key Shift	-24+24	Shifts the FANTOM's overall pitch range in semitone steps.
Master Level	0-127	Sets the FANTOM's overall volume.
Scale Tune Sw	OFF, ON	Switches the scale tune on/off.
Output Gain	-12+12	Adjusts the FANTOM's overall output gain.

### Using the Local Switch setting

If you're using a DAW software with the FANTOM's keyboard controller section and sound generator section, you should turn the Local Switch "OFF." Here's why.

We need to connect these sections in the following order: the FANTOM's keyboard a DAW software the FANTOM's sound generator. Since the FANTOM's keyboard section and sound generator section are connected internally, such a connection order would normally be impossible. However, if the Local Switch is "OFF," the FANTOM's keyboard section and its sound generator section will be independent, allowing you to use a DAW software as shown here in the illustration.

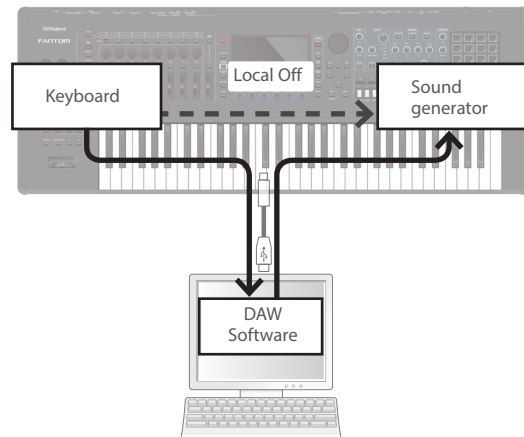

## Synchronization Settings (SYNC/TEMPO)

Parameter	Value	Explanation
Sync Mode	MASTER	The FANTOM will be the synchronization master. Choose this setting if you're using the FANTOM on its own without synchronizing it to another device, or if you want the tempo of an external MIDI device to synchronize with the FANTOM.
	REMOTE	The FANTOM will obey start, continue, and stop messages from another device, but the FANTOM own tempo setting is used as the playback tempo.
	SLAVE	The FANTOM will be the synchronization slave. Choose this setting if you want the FANTOM to synchronize to MIDI clock messages received from an external device.
Sync Output	OFF, ON	Specifies whether clock, start, continue and stop messages are transmitted to another device (ON) or are not transmitted (OFF).
System Clock Source	MIDI, USB	When the Sync Mode is "SLAVE," this setting specifies whether the FANTOM will synchronize to synchronization messages from the MIDI IN connector or from the USB port.

## Click Settings (CLICK)

Parameter	Value	Explanation
Click Mode		Specifies how the click will be sounded.
	OFF	No click is sounded.
	PLAY-ONLY	The click sounds when a song is playing.
	REC-ONLY	The click sounds when sequencer is being recorded.
	PLAY&REC	The click sounds when sequencer is playing or being recorded.
	ALWAYS	The click sounds at all times.
Click Level	0-10	Adjusts the click volume.
Click Sound		Selects the click sound.
	TYPE1	Conventional metronome sound (first beat is a bell)
	TYPE2	Click sound
	TYPE3	Beep sound
	TYPE4	Cowbell sound
Click Accent Switch	OFF, ON	Adds an accent to the click sound.
Click Output Assign	MAIN, SUB1, SUB2	Specifies whether the click sound is output from the MAIN OUTPUT jacks (MAIN) or from the SUB OUT jack (SUB1, SUB2).

## Note Pad Settings (NOTE PAD)

Parameter	Value	Explanation
Zone		
Pad1 Zone-Pad16 Zone	ZONE1-16	Specifies the zone to which note messages are sent when you strike the pads.
Note Number		
Pad1 Note Number-Pad16 Note Number	0(C)-127(G9)	Specifies the note number of the note messages that are sent when you strike the pads.
Velocity		
Pad1 Velocity-Pad16 Velocity	OFF, 1-127	Specifies the velocity of the note messages that are sent when you strike the pads.

## Control Function Settings (CONTROL)

Parameter	Value	Explanation
Control Source Select	SYS	Use System Control Source 1-4 for tone control.
	SCENE	Use the scene's Tone Control Source 1-4 settings for tone control.
System Control Source1-4	OFF, CC01-31, 33-95, BEND, AFT	Specify the MIDI messages that will be used as system controls. System Control settings allow you to specify MIDI messages that will apply in common to the entire FA, and can be used for controlling volume, tone, etc. You can assign up to four MIDI messages for this type of control. If you want to make assignments for realtime control of the sound and effects for each tone independently, use "Matrix CTRL" or "MFX CTRL" For details, refer to the "Parameter Guide" (PDF).

## Information About the FANTOM Itself (INFO)

Here you can view the software version of the FANTOM.

Display	Explanation
Version	Displays the FANTOM's software version.
Build	Displays the FANTOM's software build.

## Memo

# 10: Appendix

## Contents

---

<b>Chord Memory List</b> .....	<b>120</b>
<b>Block Diagram</b> .....	<b>122</b>
<b>Error Message List</b> .....	<b>123</b>
<b>Troubleshooting</b> .....	<b>124</b>
<b>MIDI Implementation Chart</b> .....	<b>128</b>
<b>Main Specifications</b> .....	<b>130</b>

---

# Chord Memory List

## 01: Pop 1

Assign Key	Chord Name	Constituent Notes of Chord Forms
C	Cadd9	C3, G3, D4, E4
C#	C#maj9	C#3, C4, D#4, F4
D	D-7	D3, F4, A3, C4
D#	D#maj7	D#3, A#3, D4, G4
E	Cadd9 (on E)	E3, C4, D4, G4
F	Fmaj9	F2, A3, E4, G4
F#	Dadd9 (on F#)	F#2, A3, D4, E4
G	Cadd9 (on G)	G2, D4, E4, G4
G#	F-6 (on Ab)	G#2, C4, D4, F4
A	F (on A)	A2, A3, C4, F4
A#	G- (on Bb)	A#2, A#3, D4, G4
B	G (on B)	B2, B3, D4, G4

## 02: Pop 2

Assign Key	Chord Name	Constituent Notes of Chord Forms
C	Cmaj9	C3, E3, B3, D4
C#	C#dim7	C#3, G3, A#3, E4
D	D-9	D3, F3, C4, E4
D#	D#dim7	D#3, A3, C4, F#4
E	E-7	E3, B3, D4, G4
F	Fmaj9	F3, A3, E4, G4
F#	F#-7 (b5)	F#3, A3, C4, E4
G	G7sus4 (9 13)	G2, A3, C4, F4
G#	G#dim7	G#2, B3, D4, F4
A	A-9	A2, B3, C4, G4
A#	C7(on Bb)	A#2, G3, C4, E4
B	B-7(b5)	B2, A3, D4, F4

## 03: Jazz 1

Assign Key	Chord Name	Constituent Notes of Chord Forms
C	C6 9	C3, E3, A3, D4
C#	C#7(#9)	C#3, F3, B3, E4
D	D-9	D3, F3, C4, E4
D#	D#7(#9)	D#3, G3, C#4, F#4
E	E#7(#9)	E3, G#3, D4, G4
F	Fmaj9	F3, A3, E4, G4
F#	F#7(#9)	F#3, A#3, E4, A4
G	G7(13)	G2, F3, B3, E4
G#	G#7(13)	G#2, F#3, C4, F4
A	A-7(11)	A2, G3, C4, D4
A#	Bb9	A#2, G#3, C4, D4
B	B-7(11)	B2, A3, D4, E4

## 04: Jazz 2

Assign Key	Chord Name	Constituent Notes of Chord Forms
C	C6 9	C3, E3, A3, D4
C#	C#9	C#3, F3, B3, D#4
D	D-9	D3, F3, C4, E4
D#	D#9	D#3, G3, C#4, F4
E	E-9	E3, G3, D4, F#4
F	F-9	F2, G#3, D#4, G4
F#	F#-7(b5)	F#2, A3, C4, E4
G	G7(b13)	G2, F3, B3, D#4
G#	G#7(13)	G#2, F#3, C4, F4
A	A7(b13)	A2, G3, C#4, F4
A#	Bb7(13)	A#2, G#3, D4, G4
B	B-7(11)	B2, A3, D4, E4

## 05: Jazz 3

Assign Key	Chord Name	Constituent Notes of Chord Forms
C	Cmaj9	C3, E3, G3, B3, D4
C#	Dbmaj7	C#3, F3, G#3, C4, D#4
D	Dmaj9	D3, F#3, A3, C#4, E4
D#	Ebmaj9	D#3, G3, A#3, D4, F4
E	Emaj9	E3, G#3, B3, D#4, F#4
F	Fmaj9	F3, A3, C4, E4, G4
F#	Gbmaj9	F#3, A#3, C#4, F4, G#4
G	Gmaj9	G3, B3, D4, F#4, A4
G#	Abmaj9	G#3, C4, D#4, G4, A#4
A	Amaj9	A3, C#4, E4, G#4, B4
A#	Bbmaj9	A#3, D4, F4, A4, C5

## 06: Blues

Assign Key	Chord Name	Constituent Notes of Chord Forms
C	C7(9)	C3, A#3, D4, E4
C#	C#7(9)	C#3, F3, B3, D#4
D	D7(9)	D3, F#3, C4, E4
D#	D#7(9)	D#3, G3, C#4, F4
E	E7(#9)	E3, G#3, D4, G4
F	F7(9)	F2, A3, D#4, G4
F#	F#dim7	F#2, A3, C4, D#4
G	G7(13)	G2, F3, B3, E4
G#	G#dim7	G#2, B3, D4, F4
A	A7(b13)	A2, G3, C#4, F4
A#	Bb7(13)	A#2, G#3, D4, G4
B	B-7(b5)	B2, A3, D4, F4

## 07: Trad Maj

Assign Key	Chord Name	Constituent Notes of Chord Forms
C	C	C3, E4, G4, C5
C#	C#dim7	C#3, E4, G4, A#4
D	D-	D3, D4, F4, A4
D#	D#dim7	D#3, F#4, A4, C5
E	E-	E3, E4, G4, B4
F	F	F3, F4, A4, C5
F#	F#-7(b5)	F#3, E4, A4, C5
G	G	G3, D4, G4, B4
G#	G#dim7	G#3, D4, F4, B4
A	A-	A2, E4, A4, C5
A#	Bb	A#2, D4, F4, A#4
B	Bdim	B2, D4, F4, B4

## 08: Trad Min 1

Assign Key	Chord Name	Constituent Notes of Chord Forms
C	C-	C3, D#4, G4, C5
C#	Db	C#3, C#4, F4, G#4
D	Ddim	D3, D4, F4, G#4
D#	Eb	D#3, D#4, G4, A#4
E	Edim7	E3, C#4, G4, A#4
F	F-	F2, C4, F4, G#4
F#	Gbdim7	F#2, C4, D#4, A4
G	G-	G2, A#3, D4, G4
G#	Ab	G#2, C4, D#4, G#4
A	A-7(b5)	A2, C4, D#4, G4
A#	Bb	A#2, D4, F4, A#4
B	Bdim7	B2, D4, F4, G#4

## 09: Trad Min 2

Assign Key	Chord Name	Constituent Notes of Chord Forms
C	C-	C3, D#4, G4, C5
C#	Db	C#3, C#4, F4, G#4
D	Ddim	D3, D4, F4, G#4
D#	Eaug	D#3, D#4, G4, B4
E	E-	E3, E4, G4, B4
F	F-	F2, C4, F4, G#4
F#	Gbdim7	F#2, C4, D#4, A4
G	G	G2, B3, D4, G4
G#	Ab	G#2, G#4, D#4, C4
A	A-7(b5)	A2, C4, D#4, G4
A#	Bb	A#2, D4, F4, A#4
B	Bdim	B2, D4, F4, B4

## 10: Pop Min 1

Assign Key	Chord Name	Constituent Notes of Chord Forms
C	C-add9	C3, D4, D#4, G4
C#	Dbmaj7	C#3, G#3, C4, F4
D	D-7(b5)	D3, C4, F4, G#4
D#	Ebmaj7	D#3, A#3, D4, G4
E	Edim7	E3, A#3, C#4, G4
F	F-7(9)	F2, G#3, D#4, G4
F#	Gbdim7	F#2, A3, C4, D#4
G	G-7	G2, A#3, D4, F4
G#	Abmaj7	G#2, C4, D#4, G4
A	A-7(b5)	A2, C4, D#4, G4
A#	Bb7sus4(9 13)	A#2, G#3, C4, D#4



11: Pop Min 2

Assign Key	Chord Name	Constituent Notes of Chord Forms
C	C-add9	C3, D4, D#4, G4
C#	Eb7(on Db)	C#3, A#3, D#4, G4
D	D-7(b5)	D3, G#3, C4, F4
D#	Ebmaj7	D#3, A#3, D4, G4
E	Emaj7(9)	E3, G#3, D#4, F#4
F	F-7(9)	F2, G#3, D#4, G4
F#	Gbdim7	F#2, A3, C4, D#4
G	G7(b13)	G2, F3, B3, D#4
G#	Abmaj7	G#2, C4, D#4, G4
A	A-7(b5)	A2, C4, D#4, G4
A#	C-7(on Bb)	A#2, C4, D#4, G4
B	C-maj7(B)	B2, D4, D#4, G4

12: Jazz Min 1

Assign Key	Chord Name	Constituent Notes of Chord Forms
C	C-7(11)	C3, A#3, D#4, F4
C#	Db7(#9)	C#3, F3, B3, E4
D	D-7(b5)	D3, C4, F4, G#4
D#	Ebaug maj7	D#3, B3, D4, G#4
E	E7(9)	E2, G#3, D4, F#4
F	F7(9)	F2, A3, D#4, G4
F#	Gbdim7	F#2, A3, C4, D#4
G	G7(#9)	G2, B3, F4, A#4
G#	Abmaj7(#11)	G#2, C4, D4, G4
A	A-7(b5)	A2, C4, D#4, G4
A#	Bb-7	A#2, G#3, C#4, F4
B	Bdim7	B2, G#3, D4, F4

13: Jazz Min 2

Assign Key	Chord Name	Constituent Notes of Chord Forms
C	C-7(9)	C3, D#3, A#3, D4
C#	Db7(9)	C#3, F3, B3, D#4
D	D-7(9)	D3, F3, C4, E4
D#	Eb7(9)	D#3, G3, C#4, F4
E	Emaj7(9)	E2, G#3, D#4, F#4
F	F-7(9)	F2, G#3, D#4, G4
F#	Gbdim7	F#2, A3, C4, D#4
G	G7(13)	G2, F3, B3, E4
G#	Ab-6	G#2, B3, D#4, F4
A	A-7(b5)	A2, C4, D#4, G4
A#	Bb-7	A#2, G#3, C#4, F4
B	B-7(b5)	B2, A3, D4, F4

14: Oct Stack

Assign Key	Chord Name	Constituent Notes of Chord Forms
C	---	C4, C5
C#	---	C#4, C#5
D	---	D4, D5
D#	---	D#4, D#5
E	---	E4, E5
F	---	F4, F5
F#	---	F#4, F#5
G	---	G4, G5
G#	---	G#4, G#5
A	---	A4, A5
A#	---	A#4, A#5
B	---	B4, B5

15: 4th Stack

Assign Key	Chord Name	Constituent Notes of Chord Forms
C	---	C4, F4
C#	---	C#4, F#4
D	---	D4, G4
D#	---	D#4, G#4
E	---	E4, A4
F	---	F4, A#4
F#	---	F#4, B4
G	---	G4, C5
G#	---	G#4, C#5
A	---	A4, D5
A#	---	A#4, D#5
B	---	B4, E5

16: 5th Stack

Assign Key	Chord Name	Constituent Notes of Chord Forms
C	---	C4, G4
C#	---	C#4, G#4
D	---	D4, A4
D#	---	D#4, A#4
E	---	E4, B4
F	---	F4, C5
F#	---	F#4, C#5
G	---	G4, D5
G#	---	G#4, D#5
A	---	A4, E5
A#	---	A#4, F5
B	---	B4, F#5

17: Scale Set

Assign Key	Chord Name	Constituent Notes of Chord Forms
C	Major Scale	C4, D4, E4, F4, G4, A4, B4
C#	Major Pentatonic Scale	C4, D4, E4, G4, A4
D	Minor Scale	C4, D4, D#4, F4, G4, G#4, A#4
D#	Harmonic Minor Scale	C4, D4, D#4, F4, G4, G#4, B4
E	Melodic Minor Scale	C4, D4, D#4, F4, G4, A4, B4
F	Whole Tone Scale	C4, D4, E4, F#4, G#4, A#4
F#	Blue note Scale	C4, D#4, F4, F#4, G4, A#4
G	Japanese Minor	C4, C#4, F4, G4, A#4
G#	Ryukyu Scale	C4, E4, F4, G4, B4
A	Bari Scale	C4, C#4, D#4, G4, G#4
A#	Spanish Scale	C4, C#4, E4, F4, G4, G#4, A#4
B	Gypsy Scale	C4, C#4, E4, F4, G4, G#4, B4

\* To change the key of a chord set, change the value for "KEY" in the "CHORD MEMORY" screen.

The illustration below shows how to determine the key of the song from the key signature (the number of # and b symbols).

Major C F B<sup>b</sup> E<sup>b</sup> A<sup>b</sup> D<sup>b</sup> G<sup>b</sup>

Minor Am Dm Gm Cm Fm B<sup>b</sup>m E<sup>b</sup>m

Major G D A E B F#

Minor Em Bm F#m C#m G#m D#m

# Block Diagram

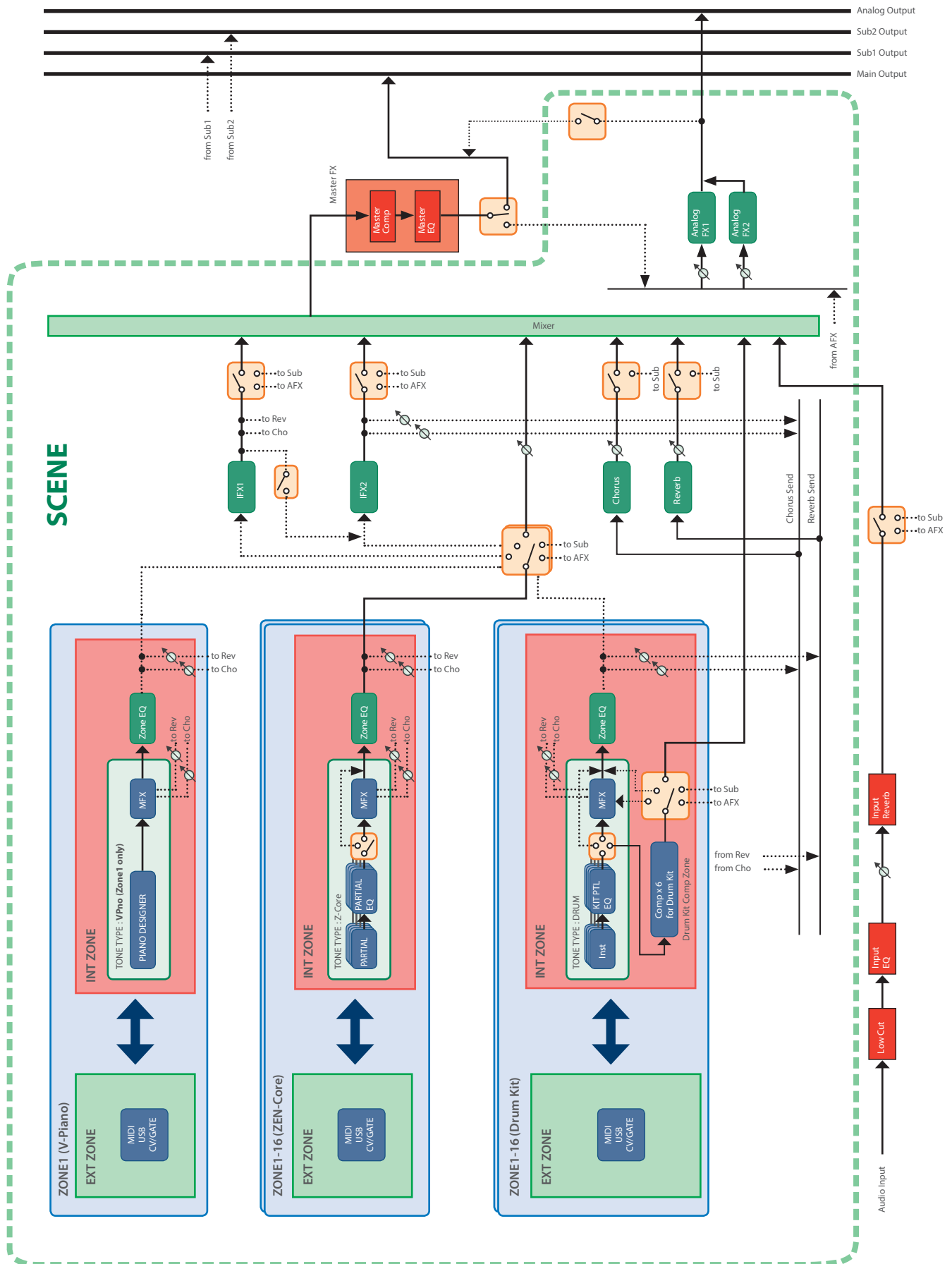

# Error Message List

If an incorrect operation is performed, or if processing could not be performed as you specified, an error message appears.

Refer to the explanation for the error message that appears, and take the appropriate action.

Message	Meaning	Action
USB Memory Not Ready!	The USB flash drive is not inserted, or is inserted incompletely.	Turn off the power, insert the USB flash drive correctly, and then turn the power on again (p. 20).
	The USB flash drive was removed after you selected data that was on the USB flash drive.	
	The format of the USB flash drive is invalid.	
Storage Full!	There is insufficient space in the writing-destination.	Delete unneeded data.
Incorrect File!	The format of the file being imported is invalid or unsupported.	Use a file format that the FANTOM supports. Audio files (WAV/AIFF/MP3) are supported (p. 68).
Not Found! Empty PAD was not found.	During AUTO IMPORT of samples, there were not enough empty pads for the samples being imported.	Use the sample DELETE function (p. 72) to prepare a sufficient number of empty pads, and then try the operation again.
Sample Too Long!	The allowable sampling time has been exceeded.	–
Sample Length Too Short!	The sample is too short, and cannot be edited correctly.	If the sample is extremely short, editing may not produce the desired result.
Storage Protected!	Since the USB flash drive's lock setting is on, writing or deletion is not possible.	Turn off the power, disconnect the USB flash drive, and turn off its lock setting.
Storage Error!	There is a problem with the storage that is the target of the operation.	If the target storage is in <ul style="list-style-type: none"> <li>• A USB flash drive: Use the FANTOM to format the USB flash drive (p. 109).</li> <li>• INTERNAL STORAGE: Execute the INITIALIZE INTERNAL STORAGE operation (p. 109).</li> <li>• Sample memory: Execute the sample DELETE ALL operation (p. 72).</li> </ul> In other cases, execute a factory reset (p. 109). If this does not solve the problem, contact your dealer or customer support.
Incorrect Path!	When using File Utility, the Copy/Move destination path is invalid.	A subfolder that includes the Copy/Move source cannot be specified as the Copy/Move destination.
Invalid File/Folder Name!	The file or folder name includes characters that cannot be handled by the FANTOM.	The FANTOM cannot handle files or folders whose name includes the following characters. " * , / : ; < > ? \   ~ Nor can it handle special characters such as double-byte characters. Do not use these characters.
Invalid Char!	Unusable characters are included.	Characters that cannot be handled by the FANTOM are shown in the error message. Do not use these characters.
Pattern End!	You have exceeded the maximum measures that can be realtime-recorded.	–
Sequencer Error!	A sequencer-related error has occurred.	Turn the power off and then on again before you proceed (p. 20).
Data Full!	Since the maximum number of notes that can be stored in a pattern has been exceeded, no further recording or editing is possible.	Use the pattern utility modify commands Delete or Erase to delete unneeded data from the pattern that you're recording or editing (p. 91).
Pattern status is different!	When recording a layer consisting of multiple zones, the recording-destination includes multiple tracks of differing pattern status.	If you are layer-recording tracks, make sure that the loop settings (loop length, playback position, LOOP SW setting) for the patterns of those tracks are consistent with each other (p. 82)..
Now Recording!	Since the FANTOM is recording, this operation cannot be executed.	Stop recording before you execute the operation.
Now Playing!	Since the FANTOM is playing, this operation cannot be executed.	Stop playback before you execute the operation.
Program Version Error!	The FANTOM cannot start up. The program cannot be loaded correctly. Alternatively, the system update program might be incorrect.	Using the correct program, perform the update once again. If this does not solve the problem, contact your dealer or customer support.
MIDI Buffer Full!	An unusually large amount of MIDI data was received, and could not be processed.	Reduce the amount of MIDI messages that are being transmitted.
MIDI Offline!	The MIDI IN connection was broken.	Check that there is no problem with the MIDI cable connected to the FANTOM's MIDI IN, and that the MIDI cable was not disconnected.

# Troubleshooting

Problem	Items to check	Action	Page
<b>Overall problems</b>			
The unit turns off unexpectedly	Check the "Auto Off" system setting.	The FANTOM will automatically be turned off when no operation has been performed for a certain length of time. (At the factory settings, the power will be turned off after 4 hours.) If you want the FANTOM to stay on, change the "Auto Off" system setting to "OFF."	p. 20
Power won't turn on	Are the included AC adaptor and power cord correctly connected to an outlet and to the FANTOM?	Do not use any AC adaptor or power cord other than the supplied items. Doing so will cause malfunctions.	p. 10
<b>Problems with the sound</b>			
No sound	Are your amp, speakers, headphones, etc., connected correctly?	Correctly connect your amp, speakers, and headphones.	p. 10
	Is the connected amp or speaker powered up?	Turn on the power of the connected amp or speaker.	p. 10
	Could the volume of a connected device have been lowered?	Adjust the volume of the connected equipment.	–
	Could the [MASTER VOLUME] knob be set to the minimum level?	Adjust the [MASTER VOLUME] knob.	p. 8
	Can you connect headphones and hear sound through them?	If you hear sound through your headphones, it may be that there is a broken connection cable, or that your amp or mixer have malfunctioned. Check your connection cables and equipment once again.	–
	Is the output destination settings correct?	Check the Zone Output Assign setting. For details, refer to "Parameter Guide" (PDF).	–
	Could you be using a connection cable that contains a resistor?	Use a connection cable that does not contain a resistor.	–
	If pressing the keyboard does not produce sound, could the Local switch be turned off?	Turn the Local Switch "ON."	p. 116
	Could the tone's partials be turned off?	Turn the Partial Switch "ON."	p. 45
	Could the level setting be too low?	In the system parameter Sound tab, check the Master Level.	p. 116
	Are the effect settings correct?	Check the effect on/off settings. Also check settings such as effect level.	p. 50
	Could the volume be lowered by a pedal operation or slider operation?	Raise the volume of zones that are not producing sound. Advance the pedals, raise the sliders, or check the settings of the various controllers.	p. 36, p. 37
	Could the volume be lowered by MIDI messages (volume messages and expression messages) received from an external MIDI device?	Check the volume messages or expression messages that are received from an external MIDI device.	–
	No sound from a specific zone	Could the volume of the zone have been lowered?	Adjust the Level setting to raise the volume of the zone that you don't hear.
Could the settings of a specific zone be muted?		Defeat muting.	–
Could the settings of a specific zone be soloed?		Defeat solo.	–
Could the Zone Switch be set to EXT?		Set the Zone Sw to INT or COMMON.	p. 8
No sound from a specific range of keys	Could Zone Select be set to a different zone?	Select the zone that you want to play.	p. 24
	Could a key range be set?	If you don't hear sound from a specific range of keys, check the key range settings.	p. 26
Sound is distorted	Could you be applying an effect that intentionally distorts the sound?	If the sound of a specific tone or zone is distorted, lower the volume of that tone or zone.	p. 36
	Could the [MASTER VOLUME] knob be set too high?	If the overall sound is distorted, lower the [MASTER VOLUME] knob.	p. 8
	Could the Output Gain be raised excessively?	In the Sound system settings, check the Output Gain setting.	p. 116
	Could the volume being input to the Analog Filter be excessive?	In the Analog Filter section, set the Level appropriately.	p. 53
	Could a system effect be applied?	In some cases, the sound might be distorted by the M.COMP or M.EQ settings. Check the M.COMP and M.EQ settings.	p. 55
Pitch is wrong	Could the FANTOM's tuning be incorrect?	In the Sound system settings, check the Master Tune setting.	p. 116
	Could the pitch have been changed by a pedal operation or by a pitch bend message received from an external MIDI device?	Check the pedal and the pitch bender.	p. 37
	Could the Coarse Tune, Fine Tune, or Master Tune parameters be set?	Check the Coarse Tune, Fine Tune, and Master Tune settings. For details on the parameters, refer to "Parameter Guide" (PDF).	–
Notes are broken off	The sound is interrupted if the maximum polyphony is exceeded.	Reduce the number of zones that you're using. Increase the VOICE RESERVE setting for zones in which you want to avoid dropped notes. For details, refer to "Parameter Guide" (PDF).	–
Notes remain sounding when you play the keyboard	Could the polarity of the hold pedal be reversed?	Check the system setting Hold Pedal Polarity.	p. 113

Problem	Items to check	Action	Page
Sound is still heard from the opposite side as well even when panned all the way to one side	Could effects be applied?	Since the FANTOM's internal effects are stereo, applying an insert effect will allow effect sound to be heard from the opposite side even if the source sound is panned all the way to one side.	–
Notes played in a high register sound funny	When you play high notes on the FANTOM, you might hear notes that fail to sound, whose pitch fails to rise, or a noise that changes depending on the note you play (a warbling, chirping, rustling, beeping, etc.)	This is usually because you have exceeded the highest note that the FANTOM is able to produce, and won't occur with the notes you would normally use. This does not indicate a malfunction.	–
Can't play arpeggios	Could the zone's ARP Switch be "OFF"?	Turn the applicable zone's ARP Switch "ON." Even if the [ARPEGGIO] button is on, an arpeggio will not play unless the zone's ARP Switch is "ON."	p. 30
Can't perform using the chord memory function	Could the zone's ARP Switch be "OFF"?	Turn the applicable zone's ARP Switch "ON." Even if the [CHORD MEMORY] button is on, you can't use chord memory performance unless the zone's ARP Switch is "ON."	p. 32
Pitch sometimes fails to rise when playing legato	When the Legato Switch is "ON" and Legato Retrigger is "OFF" and you hold down a low note and play a high note to produce a legato effect, the pitch might stop at a certain point and fail to rise as far as you expect because the upper limit of the wave data has been exceeded. If the tone uses multiple waves, and each of these waves has a different upper limit, the result might no longer sound mono.	If you want to make large changes in the pitch, you should turn Legato Retrigger "ON." For details on the parameters, refer to "Parameter Guide" (PDF).	–
When you press a sample pad or note pad, the sound remains "stuck" on	Could the [HOLD] button be lit?	Press the [HOLD] button once again to make the button go dark.	–
Sound does not stop when you press a sample pad.	Could the sample parameters GATE SW and LOOP SW both be off?	When the sample parameters GATE SW and LOOP SW are both off, one-shot playback occurs, meaning that once the sample is triggered by the pad, it continues to play to the end of the waveform. For this reason, when playing a long sample, it may seem that the sound cannot be stopped. In such situations, press the [HOLD] button four times in rapid succession. This stops all sounds that are being played by the pads.	p. 64
<b>Problems with the effects</b>			
Effect not applied	Could the effect switch be off?	Check the on/off setting of each effect.	p. 50
	Check the send level to each effect.	The effect won't be obtained if the send level to that effect is set at 0. Even if the send levels to the effect is set above 0, the effect won't be applied if the multi-effect level, or reverb level are set to 0. Check each of these settings.	
You specified a delay time value (for example for multi-effect DELAY) as a note value, but there's a limit beyond which the delay time will not change	Check the delay time setting.	Since the delay time has an upper limit, specifying the delay time as a note value and then slowing down the tempo may reach this upper limit. The maximum delay time is the highest value that can be specified numerically (i.e., other than in terms of a note value). For details on the parameters, refer to "Parameter Guide" (PDF).	–
The Modulation or other controller is always on	Check the matrix control settings.	For Z-Core tones, you can use matrix control to control the tone in real time. Matrix control uses MIDI messages such as incoming MIDI control changes as a source to modify the parameters of a tone. Depending on these settings, the FANTOM may respond to MIDI messages from an external MIDI device and be in an unexpected state. For details on the parameters, refer to "Parameter Guide" (PDF).	–
<b>Problems with the sequencer</b>			
After recording, there's no sound when you play back the pattern	Could a specific track be muted?	Defeat muting.	p. 83
	Could a specific track be soloed?	Defeat solo.	p. 83
The tempo is different than when the pattern was played a previous time	Did you save the scene?	When you change the tempo and play back, the FANTOM does not save that tempo unless you save the scene. If you want to keep the modified tempo, save the scene.	p. 44
After playing a song on the sequencer, there is no longer sound	Could the song data contain data that set the volume to zero?	After playing a song that ends with a fade-out, sound might no longer be heard. In this case it may be that a volume message or expression message has lowered the volume. Check each value and set it appropriately.	–

## Troubleshooting

Problem	Items to check	Action	Page
Performances are sluggish, or have interruptions	The sound will be interrupted if the maximum polyphony is exceeded.	Try reducing the number of notes that are played. In some cases, sustained notes with a long release might cause processing to continue even though the notes are no longer actually audible. In such cases, the polyphony of the performance data differs from the number of notes that you hear.	–
	Is there an Aftertouch or other such large Control Change at the point where the song performance is sluggish?	If the data is no longer needed, delete the data.	p. 93
	Is the data concentrated at the beginning of the beats in the sequence data?	Try spreading the data apart so that it does not occur at the same timing. It is easy for data to be concentrated at the first beat of the song if you use step recording to enter the song data, or if you apply quantization after realtime input from the keyboard. This causes a large amount of data to be sent to the FANTOM in a short time, possibly causing a delay in note processing.	p. 86
<b>Problems with saving</b>			
A scene sounds different than when you saved it	Save the tones.	If you edit the tones used by scene, or if the temporary tones of the scene were rewritten from an external MIDI device, you'll need to save those tones as well.	p. 48
	Check the effect settings.	It might be that the master effect (system effect) settings have changed.	p. 55
Arpeggio and controller settings differ between studio sets	Check the arpeggio and controller settings.	Arpeggio and controller settings are independently saved for each scene.	p. 31
<b>Problems with external MIDI devices</b>			
No sound from an external MIDI device	Does the MIDI transmit channel of the zone set to EXT match the MIDI receive channel of the connected device?	Match the zone's transmit channel with the connected device's receive channel. For details, refer to "Parameter Guide" (PDF).	–
	Is the zone that you want to output MIDI unlit, or set to EXT?	Unless the current zone is unlit, or unless one of the zones is set to EXT, playing the keyboard will not transmit MIDI messages.	p. 8
	Is the zone set to EXT assigned to output MIDI?	Unless the zone set to EXT is the current zone, or unless the keyboard is connected via a layer that includes another current zone, MIDI messages are not transmitted.	p. 8
Exclusive messages are not received	Could Receive Exclusive be turned "OFF"?	Turn Receive Exclusive "ON."	p. 115
	Does the transmitting unit's Device ID number match the FANTOM's Device ID number?	Set the Device ID numbers.	p. 115
When the tone's bend range is large (48), the pitch does not rise to its full extent when a MIDI pitch bend message is received	Although a tone's bend range can be set in a range of 0–48, there are some waves for which the pitch cannot rise to the full extent of the pitch bend message, causing the pitch to stop rising at a certain point. We guarantee that the pitch will rise at least to a pitch bend range setting of 12, but please use caution if you specify a bend range that is greater than this.	–	–

Problem	Items to check	Action	Page
<b>Problems with the sampling</b>			
Can't sample a stereo waveform	Could the Format be set to "MONO"?	Set the Format to "STEREO."	p. 66
Sampled sound contains excessive noise or distortion	Is the input level appropriate?	If the input level is too high, the sound will distort. If the input level is too low, noise will be obtrusive. Adjust the input level to an appropriate setting.	p. 66
	Are the effect settings appropriate?	Some types of effect may increase the level louder than the original sample, or may intentionally distort the sound. Some effects will also cause noise to be emphasized. Temporarily turn off effects, and check whether the sample itself contains noise or distortion. Then adjust the effect settings appropriately.	-
	Are multiple samples being played simultaneously?	Even if the level of each individual sample is appropriate, simultaneously playing multiple samples may cause the overall level to be excessively high, causing distortion. Lower the level of each sample so that the sound is not distorted.	p. 70
<b>Problems with a microphone or external device you're recording</b>			
External input sound is not stereo	Could the stereo 1/4" phone plug carrying the stereo signal be connected to INPUT jack 1 or 2?	MIC/LINE INPUT jacks 1 and 2 are each mono jacks. To input in stereo, connect the L channel to MIC/LINE INPUT jack 1 and the R channel to MIC/LINE INPUT jack 2.	p. 10
External input sound is absent or too quiet	Could the input volume be lowered? Is the input gain (LINE/MIC) set appropriately for the device that's connected?	For an external audio device (external sound module, music player, etc.): Adjust the volume on the connected device. Set the input gain to "LINE." Adjust the rear panel LEVEL knobs 1 and 2.  For a mic: Set the input gain to "MIC." Adjust the rear panel LEVEL knobs 1 and 2. If you're using a condenser mic, turn on phantom power.	p. 66
Mic sound is absent or too quiet		If the volume still does not increase, adjust the Input Level.	
Sound from the PC is absent or too quiet		For audio signals from the USB COMPUTER port: Adjust the volume on the computer. Adjust the USB Audio Input Level.	
	Could AUDIO IN be off?	Turn AUDIO IN on.	p. 66
	Are the connection cables connected correctly?	Check the connections.	p. 10
	A connection cable may be broken.	-	-
	Could you be using a connection cable that contains a resistor?	Use a connection cable that does not contain a resistor.	-
<b>Problems with a USB flash drive</b>			
USB flash drive is not recognized	Check the format of the USB flash drive.		
Data on the USB flash drive was damaged	Could a strong physical shock have been applied to the USB flash drive?	Format the USB flash drive on the FANTOM.	p. 109
	Could the power have been turned off while accessing the USB flash drive?		
	Could you have formatted the card on a computer or digital camera?		
Can't back up to USB flash drive	Could the USB flash drive be write protected?	Disable write protection.	-
	Is there sufficient free space on the USB flash drive?	Use a USB flash drive that has sufficient free space.	-
	Check the USB flash drive format. The FANTOM can use a USB flash drive that is formatted in FAT32.	Format the USB flash drive on the FANTOM.	p. 109
<b>Problems with USB connection</b>			
The FA is not detected by the computer	Does your computer's USB port support USB 2.0 Hi-Speed?	The USB port of the computer to which the FANTOM is connected must support USB 2.0 Hi-Speed.	-

# MIDI Implementation Chart

## Sound generator section

Date : Sep. 1, 2019

Model FANTOM-6/7/8

Version : 1.00

Function...		Transmitted	Recognized	Remarks
Basic Channel	Default Changed	1-16 1-16	1-16 1-16	
Mode	Default Message Altered	Mode 3 Mono, Poly *****	Mode 3 Mode 3, 4 (M=1)	*2
Note Number	: True Voice	0-127 *****	0-127 0-127	
Velocity	Note On Note Off	o o	o o	
After Touch	Key's Channel's	x o	o *1 o *1	
Pitch Bend		o	o *1	
Control Change	0, 32	o	o *1	Bank select
	1	o	o *1	Modulation
	2	o	o	Breath type
	4	o	o	Foot type
	5	o	o	Portamento time
	6, 38	o	o	Data entry
	7	o	o *1	Volume
	10	o	o *1	Panpot
	11	o	o *1	Expression
	16	o	o	General purpose controller 1
	17	o	o	General purpose controller 2
	18	o	o	General purpose controller 3
	19	o	o	General purpose controller 4
	64	o	o *1	Hold 1
	65	o	o	Portamento
	66	o	o	Sostenuto
	67	o	o	Soft
	68	o	o	Legato foot switch
	71	o	o	Resonance
	72	o	o	Release time
	73	o	o	Attack time
	74	o	o	Cutoff
	75	o	o	Decay time
	76	o	o	Vibrato rate
	77	o	o	Vibrato depth
	78	o	o	Vibrato delay
	80	o	o	General purpose controller 5
	81	o	o	General purpose controller 6
82	o	o	General purpose controller 7	
83	o	o	General purpose controller 8	
84	o	o	Portamento control	
88	o *1	o *4	High resolution velocity prefix	
91	o	o (Reverb)	General purpose effect 1	
93	o	o (Chorus)	General purpose effect 3	
1-31, 33-95	o	-	General purpose controller	
96, 97	x	x	Increment, Decrement	
98, 99	x	x	NRPN LSB, MSB	
100, 101	o	o	RPN LSB, MSB	
Program Change	: True Number	o *1 *****	o *1 0-127	Program Number 1-128
System Exclusive		o *3	o *1	
System Common	: Song Position : Song Select : Tune	x x x	x x x	
System Realtime	: Clock : Commands	x x	o x	
Aux Messages	: All Sound Off : Reset All Controllers : Local On/Off : All Notes Off : Active Sensing : System Reset	x x x x o *1 x	o o x o (123-127) o x	
Notes		*1 O X is selectable. *2 Recognized as M=1 even if M≠1. *3 Transmitted only when "Transmitted Edit Data" is ON or RQ1 is received. *4 Received V-Piano tone only.		

Mode 1: Omni On, Poly  
Mode 3: Omni Off, Poly

Mode 2: Omni On, Mono  
Mode 4: Omni Off, Mono

o: Yes  
x: No



Sequencer section

Date : Sep. 1, 2019

Version : 1.00

Model FANTOM-6/7/8

Function...	Transmitted	Recognized	Remarks
Basic Channel Default Changed	All channel x	All channel 1-16	There is no specific basic channel
Mode Default Message Altered	x x *****	x x	
Note Number : True Voice	0-127 *****	0-127 0-127	
Velocity Note On Note Off	o o	o o	
After Touch Key's Channel's	o o	o *1 o *1	
Pitch Bend	o	o *1	
Control Change 0-119	o	o *1	
Program Change : True Number	o *****	x *****	
System Exclusive	x	x	
System Common : Song Position : Song Select : Tune	x x x	x x x	
System Realtime : Clock : Commands	o *1 o *1	o *1 o *1	
Aux Messages : All Sound Off : Reset All Controllers : Local Controll On/Off : All Notes Off : Omni Mode Off : Omni Mode On : Mono Mode On : Poly Mode On : Active Sensing : System Reset	o o x x o o o o o x x	o *1 *2 o *1 x x *3 o *1 *2 o *1 *2 o *1 *2 o *1 *2 x x	
Notes	*1 O X is selectable *2 First, a a note-off message is recorded for each note that is currently on; then this message itself is recorded *3 The All Notes Off message itself is not recorded; a note-off message is recorded for each note that is currently on		

Mode 1: Omni On, Poly  
Mode 3: Omni Off, Poly

Mode 2: Omni On, Mono  
Mode 4: Omni Off, Mono

o: Yes  
x: No

# Main Specifications

## Roland FANTOM : Music Workstation

	FANTOM-6	FANTOM-7	FANTOM-8
<b>Keyboard</b>	61 Keys semi-weighted keyboard and channel aftertouch	76 Keys semi-weighted keyboard and channel aftertouch	88 Keys PHA-50 Wood and Plastic Hybrid Structure and channel aftertouch
<b>Sound Generator</b>	ZEN-Core V-Piano Technology		
<b>Parts</b>	16 Zones(Internal + External)		
<b>Scenes</b>	128 Scenes x 4 Bank		
<b>Tones</b>	Over 3,500 Tones Over 90 Drum kits		
<b>Effects</b>	Multi-Effects: 16 systems, 90 types Part EQ: 16 systems Drum Part COMP: 6 systems Insertion Effect: 2 System, 90 Type Chorus: 8 types Reverb: 6 types Master Compressor Master EQ Mic Input Reverb: 6 types		
<b>Analog Filter</b>	STEREO Type: LPF1/LPF2/LPF3/HPF/BPF/Bypass Drive Amp		
<b>Sequencer</b>	MIDI Tracks: 16(Internal/External) Group:16 Pattern: 8 (per each Track) Pattern Length: 32 mesures Recording Method: Realtime recording, Step recording, TR-REC		
<b>Sampler</b>	PAD Sampler Format: 16-bit linear, 44.1/48kHz, WAV/AIFF import supported Maximum Polyphony: 8 Number of Samples: 16 Pads x 4 Banks		
<b>Others</b>	Rhythm Pattern Arpeggiator Chord Memory		
<b>Controllers</b>	Pitch Bend/Modulation Lever, Assignable Switch x 2 (S1/S2), Control Knob x 8, Slider x 8, USB Audio Slider, Wheel x 2 Function Knob x 6, Sound Modified Knob x 11, 4 x 4 Pad		
<b>Display</b>	Graphic Type, 7", Wide VGA (800 x 480 dots), backlit LCD (Color/Touch screen)		
<b>Connectors</b>	Headphones Jack: Stereo 1/4-inch phone type MAIN OUT Jacks (L/MONO, R) (1/4-inch phone type) MAIN OUT Jacks (L, R) (XLR type) SUB OUT1 Jacks (L, R) (1/4-inch phone type) SUB OUT2 Jacks (L, R) (1/4-inch phone type) ANALOG OUTPUT Jacks(1,2)(1/4-inch phone type) Mic/Line Input Jacks: (1,2) (1/4 inch phone type/XLR type) 2 x CV OUT, 2x GATE OUT FOOT PEDAL Jacks(HOLD, CTRL1,CTRL2,CTRL3) MIDI connectors (IN, OUT1, OUT2/THRU) USB MEMORY Port USB COMPUTER Port (AUDIO/MIDI) 3 x External Device Port		
<b>External Memory</b>	USB Flash drive (sold separately)		
<b>Power Supply</b>	AC 117-240V 50/60Hz		
<b>Current Draw</b>	50W		
<b>Dimensions</b>	1,084 (W) x 403 (D) x 106 (H) mm 42-11/16 (W) x 15-7/8 (D) x 4-3/16 (H) inches	1,296 (W) x 403 (D) x 106 (H) mm 51-1/16 (W) x 15-7/8 (D) x 4-3/16 (H) inches	1,432 (W) x 439 (D) x 153 (H) mm 56-7/16 (W) x 17-5/16 (D) x 6-1/16 (H) inches
<b>Weight</b>	15.3 kg 33 lbs 12 oz	17.7 kg 39 lbs 1 oz	27.7 kg 61 lbs 2 oz
<b>Accessories</b>	Owner's Manual Power Cord		
<b>Options</b>	Keyboard stand: KS-10Z, KS-12	Keyboard stand: KS-10Z, KS-12	Keyboard stand: KS-G8B, KS-10Z, KS-12
	Pedal Switch: DP series, RPU-3 Expression Pedal: EV-5 USB flash drive (*1) *1 Use a commercially available USB flash drive. However, we cannot guarantee that all commercially available USB flash drives will work.		

\* This document explains the specifications of the product at the time that the document was issued. For the latest information, refer to the Roland website.

## Memo

 Roland