



# NovoTouch

## User Manual

(For LK6530i, LK7530i, and LK8630i models)

# Table of Contents

- Safety..... 4**
  - Regulatory Compliance .....6
- Package Contents ..... 8**
  - Optional Accessories.....9
- Overview ..... 10**
  - Display Front View ..... 10
  - Display Rear View..... 11
  - Display Right View ..... 12
  - Display Bottom View ..... 13
  - Remote Control..... 14
    - Installing Batteries..... 15
    - Remote Control Usage ..... 15
- Installing the Wall Mount ..... 16**
- Installing the VKA05 OPS Module ..... 19**
- Connections..... 20**
  - HDMI-In (1.4/2.0)..... 20
  - DisplayPort-In ..... 20
  - VGA-In ..... 21
  - Audio-In..... 21
  - LAN (RJ-45)..... 22
  - Touch..... 22
  - AV-In ..... 23
  - RS-232 ..... 23
  - USB (2.0/3.0) ..... 23
  - microSD..... 24
  - HDMI-Out..... 24
  - Audio-Out..... 24
  - Coax-Out ..... 25
- Getting Started ..... 26**
  - Powering the Display ..... 26
  - Switching Input Source..... 27
  - Setting up an Internet Connection ..... 28

Setting up a Wi-Fi Connection ..... 28

**Display Settings..... 30**

    Audio ..... 31

    Screen ..... 31

    Display ..... 32

    Adjust ..... 32

**Using the Display ..... 33**

    Home Screen ..... 33

    NovoConnect ..... 34

    Browser ..... 35

    Note ..... 36

    System Settings..... 37

    Finder ..... 38

    Tools..... 39

**Cleaning the Display ..... 40**

**Specifications ..... 41**

**Troubleshooting ..... 42**

**Appendix (RS-232 Specifications) ..... 43**

**Copyright Statement ..... 46**

# Safety

## Placement

- Do not place the unit on an unstable cart, stand, tripod, bracket, table, or shelf.
- Do not expose the unit to direct sunlight and other sources of heat.
- Do not put the unit near appliances that generate magnetic fields.
- Do not put any liquid near or on the unit, make sure you do not spill any liquid inside the unit.
- Do not put heavy objects on top of the unit.

## Power Supply

- Check that the unit's operating voltage is identical to your local power supply.
- Please unplug the display from the power supply during possible thunder-storms or lightning.
- Please unplug the display from the power supply when the unit will be idle for a long time.
- Please prevent the power cable from receiving physical or mechanical damage.
- Please use the original power cable from the product packaging, and don't modify or lengthen it.
- Please check and ensure that the AC source is connected with the ground.
- The power cable that comes with the display is for use exclusively by this device.

## LED Screen

- This display only supports landscape display orientation. Do not mount in portrait display orientation or mount facing up or facing down.
- Never use any hard or sharp object in place of the styluses.
- Do not use permanent or dry-erase markers on the screen. If dry-erase markers are used on the screen, remove the ink as soon as possible with a lint-free, non-abrasive cloth.
- Unplug the power cable before cleaning.
- For a longer panel lifetime and better display performance, do not set the display to high brightness for a long period of time.

## Temperature

- Do not place the unit near or over a radiator or a heater.
- If your display is suddenly moved from a cold to a warm place, please unplug the power cable and do not turn it on at least 2 hours, making sure the moisture inside the unit is all evaporated.
- Normal operating temperature is 0 - 40°C.

## Humidity

- Do not expose the unit to rain, or place in a high humidity area.
- Please make sure indoor environment is dry and cool.
- Normal operating humidity is 10% - 90%.

## Ventilation

- Please put the unit in a well ventilated place, so the heating can be released easily.
- Ensure that the unit has enough space for ventilation. Space requirement: left, right and back >10cm, top > 20cm.

## Earphone

- Using the earphones to listen to loud audio for an extended period of time might affect one's hearing.
- Before using earphones, please turn down the volume in advance.

## Battery

- Please make sure the battery is properly disposed or recycled after use.
- Please keep the battery away from children.
- DO NOT throw the battery into a fire.
- For the remote control batteries, ensure that the correct batteries are used and installed in the proper orientation.

## Maintenance

- This machine should only be maintained/serviced by certified technician.
- Inspect the display mount frequently to ensure that it has remained securely installed.
- Check the mounting location for loose screws, gaps, distortions, signs of damage or weakness that can occur over time.

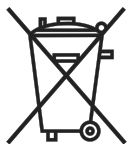

### Disposal of Old Electric and Electronic Equipment

The symbol on your product or the package represents that the product should not be treated as the normal household waste when discarded but should be carried to the recycling location of the waste electric and electronic equipment. The consequence on the environment and human health due to the incorrect disposal of the product can be prevented if it can be ensured that the product is properly discarded. Material recycling is helpful to the protection of natural resources. The symbol is only valid in European Union. If you want to discard electrical and electronic equipment, contact the governmental authorities or your dealer for the correct method of disposal.

## Important Recycling Instructions

The product may contain other electronic wastes and may pose risk if not discarded properly. Abide by the local, state/provincial or federal laws of recycling or discarding.

For more information, please visit the website and contact Electronic Industries Alliance (EIA) on [WWW.EIAE.ORG](http://WWW.EIAE.ORG).

## Regulatory Compliance

### FCC Warning

This equipment has been tested and found to comply with the limits for a Class A digital device pursuant to Part 15 of the FCC Rules. These limits are designed to provide reasonable protection against harmful interference when the equipment is operated in a commercial environment.

This equipment generates, uses, and can radiate radio frequency energy and, if not installed and used in accordance with the instruction manual, may cause harmful interference to radio communications. Operation of this equipment in a residential area is likely to cause harmful interference in which case the user will be required to correct the interference at his/her own expense.

Changes or modifications not expressly approved by the parties responsible for compliance could void the user's authority to operate the equipment.

### Federal Communications Commission (FCC) Notice (U.S. Only)

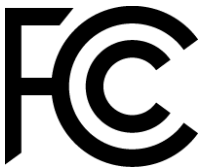

This device complies with Part 15 of the FCC Rules. Operation is subject to the following two conditions: (1) this device may not cause harmful interference, and (2) this device must accept any interference received, including interference that may cause undesired operation.

### Canada

This class A digital apparatus complies with Canadian ICES-003.

### CE Declaration of Conformity

This device complies with the requirements set out in the Council Directive on the Approximation of the Laws of the Member States relating to Electromagnetic Compatibility (2014/30/EU), Low-voltage Directive (2014/35/EU) and RoHS directive (2011/65/EU).

This product has been tested and found to comply with the harmonized standards for Information Technology Equipment, these harmonized standards published under Directives of Official Journal of the European Union.

**WARNING:** This equipment is compliant with Class A of EN55032/CISPR 32. In a residential environment this equipment may cause radio interference.

**NOTE:** This equipment has been tested and found to comply with the limits for a Class A digital device, pursuant to part 15 of the FCC Rules. These limits are designed to provide reasonable protection against harmful interference when the equipment is operated in a

commercial environment. This equipment generates, uses, and can radiate radio frequency energy and, if not installed and used in accordance with the instruction manual, may cause harmful interference to radio communications. Operation of this equipment in a residential area is likely to cause harmful interference in which case the user will be required to correct the interference at his own expense.

### **Safety Certifications**

FCC-A, cTUVus, CE, CB, EAC, RoHS

### **Disposal and Recycling**

This product may contain other electronic waste that can be hazardous if not disposed of properly. Recycle or dispose in accordance with local, state, or federal Laws. For more information, contact the Electronic Industries Alliance at [www.eiae.org](http://www.eiae.org).

# Package Contents

Ensure that all of the proper items are included with the display in the packaging. The items that should be included in the packaging are:

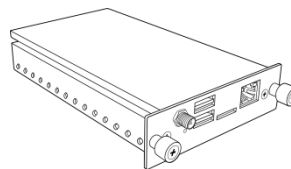
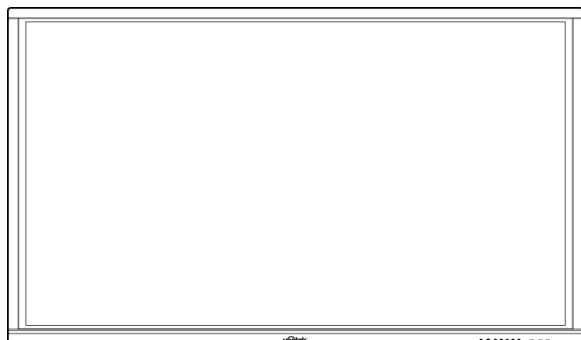

**NovoTouch**

**VKA05 OPS Module (with Antenna)**

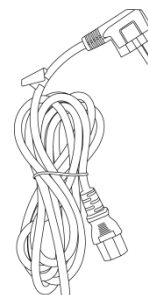
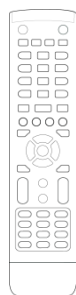

**Remote Control**

**Power Cable**

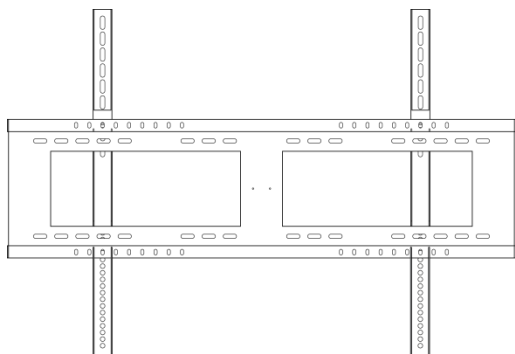

**Wall Mount Kit**

**Audio Cable**

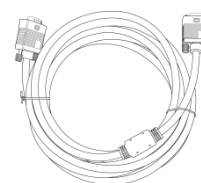
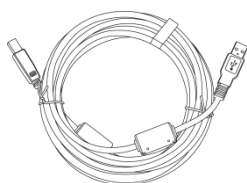

**USB Cable**

**VGA Cable**



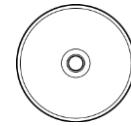

**Stylus x 3**

**Documentation CD**

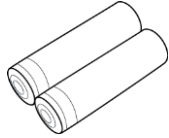

**Batteries x 2**

**Quick Guide**

## Optional Accessories

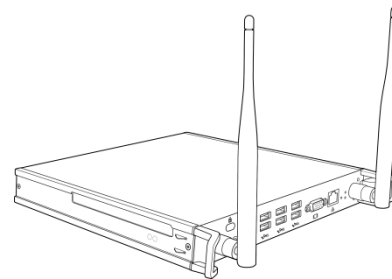
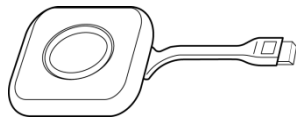

**LauncherPlus (QL300)**

**VKW21 PC OPS Module**

# Overview

## Display Front View

The following illustration shows the front side of the display and its various components:

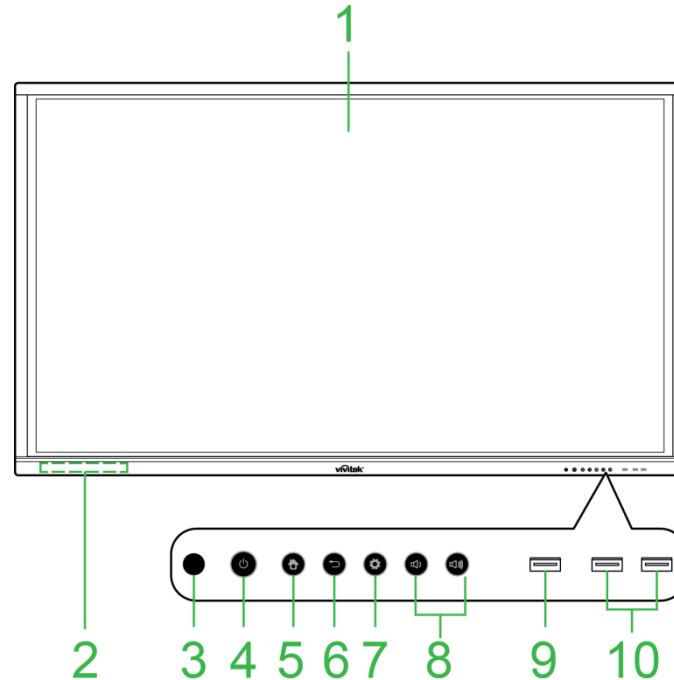

No.	Item	Description
1	Touchscreen	<ul style="list-style-type: none"> <li>Use touch gestures to navigate the display's user interface.</li> <li>Tap to wake the display when it is in standby mode (the screen is off but the display is on).</li> </ul>
2	Magnetic Stylus Holder	Holds the styluses included in with the display.
3	Remote Control IR Sensor	Receives the signal from the display's remote control with a range of up to 8 meters.
4	Power Button / Status Indicator LED	<b>Power Button:</b> <ul style="list-style-type: none"> <li>[When display is off]: Press to power on the display.</li> <li>[When display is on]: Press to place the display on standby. Press and hold for 2 seconds to power off the display.</li> </ul>
		<b>Status Indicator LED:</b> <ul style="list-style-type: none"> <li>Blue: The display is powered on or in standby mode.</li> <li>Red: The display is connected to a power source but not powered on.</li> <li>Off: The display is not connected to a power source.</li> <li>Flashing Red/Blue: (1) The display is in standby mode, (2) the display is powering off, or (3) the firmware is upgrading</li> </ul>
5	Home Button	Opens the display's home screen.
6	Back Button	Returns the display to the previous screen.
7	Settings Button	Opens the display's input source menu.
8	Volume Down/Up Button	Decreases/Increases the display's volume
9	USB 3.0 Port	Connects to a USB flash drive to view media files or to a mouse/keyboard.
10	USB 2.0 Ports	Connects to a USB flash drive to view media files or to a mouse/keyboard.

## Display Rear View

The following illustration shows the rear of the display and its various components:

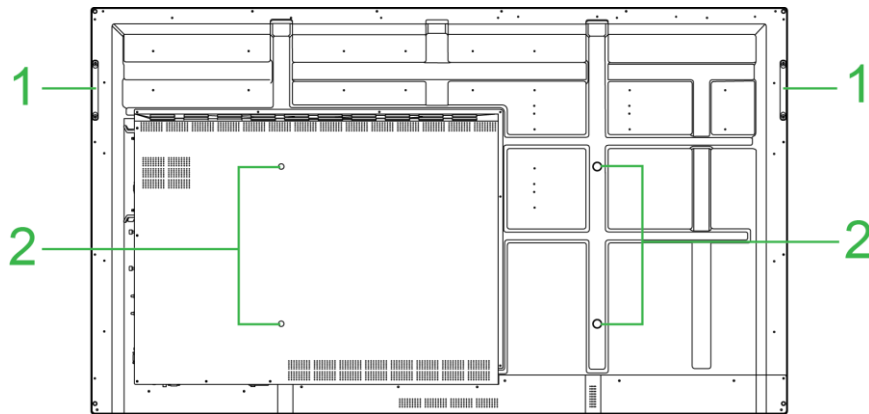

No.	Item	Description
1	Handles	Allows you to safely carry/move the display.
2	Wall Mount Screw Holes	Used to install the wall mount included with the display. See the "Installing the Wall Mount" section for more information.

## Display Right View

The following illustration shows the right side of the display and its various components:

**NOTE:** The illustration shows the right side after installation of the VKA05 OPS module. See the *Installing the VKA05 OPS Module* section for more information on how to install the OPS module.

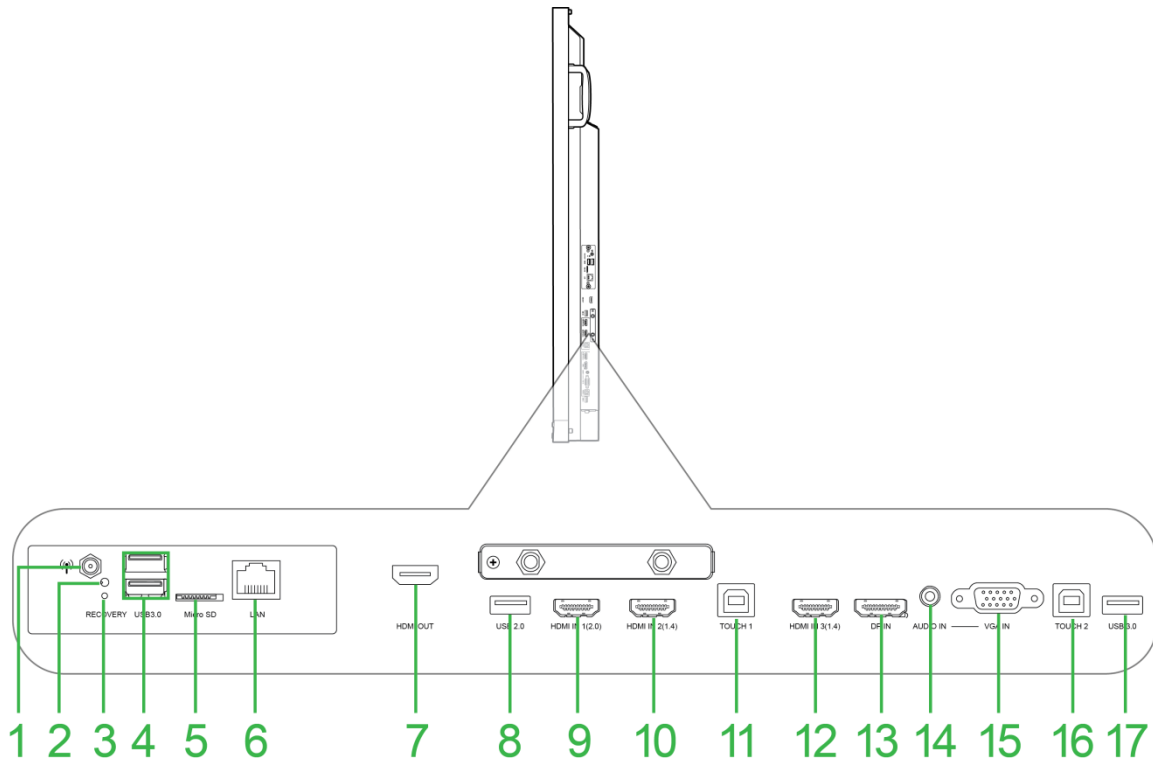

No.	Item	Description
1	Antenna Connector	Connects to the antenna included with the VKA05 OPS for Wi-Fi signal.
2	Power LED Indicator	Lights up to indicate that the VKA05 OPS is powered.
3	Recovery Button	Resets the VKA05 OPS module.
4	USB 3.0 Ports	Connects to a USB flash drive to view media files or to a mouse/keyboard.
5	microSD Card Slot	Reads media files stored on a microSD card.
6	LAN Port	Connects to a router for internet access.
7	HDMI Out Port	Connects to either a second display or projector to duplicate or extend the video shown on the display.
8	USB 2.0 Port	Connects to a USB flash drive to view media files or to a mouse/keyboard.
9	HDMI In Port 1 (2.0)	Connects to Blu-Ray/DVD players, set-top boxes, digital media players, computers, or other video sources to broadcast video and audio.
10	HDMI In Port 2 (1.4)	Connects to Blu-Ray/DVD players, set-top boxes, digital media players, computers, or other video sources to broadcast video and audio.
11	Touch Port 1	Connects to a computer to allow the touchscreen to control the computer's interface.
12	HDMI In Port 3 (1.4)	Connects to Blu-Ray/DVD players, set-top boxes, digital media players, computers, or other video sources to broadcast video and audio.
13	DisplayPort In Port	Connects to a computer to broadcast video and audio.
14	Audio In Jack	Connects to the video source to broadcast its audio.
15	VGA In	Connects to a computer to broadcast video.
16	Touch Port 2	Connects to a computer to allow the touchscreen to control the computer's interface.
17	USB 2.0 Port	Connects to a USB flash drive to view media files or to a mouse/keyboard.

## Display Bottom View

The following illustration shows the bottom of the display and its various components:

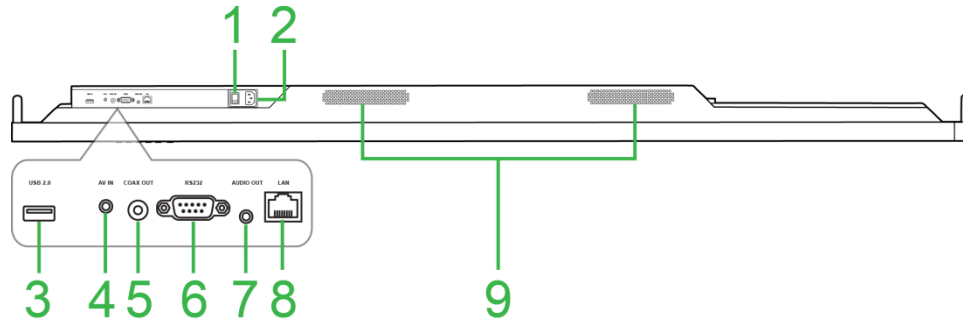

No.	Item	Description
1	Power Switch	Activates the display once it is connected to a power source.
2	Power Connector	Connects to a power outlet.
3	USB 2.0 Port	Connects to a USB flash drive to view media files or to a mouse/keyboard.
4	AV In Jack	Connects to DVD players, set-top boxes, and other sources to broadcast analog video and audio
5	Coax Out Port	Connects to external speakers to broadcast audio.
6	RS-232 Port	Connects to a computers or servers for control commands.
7	Audio Out Jack	Connects to external speakers to broadcast audio.
8	LAN Port	DISABLED: Do not connect this port.
9	Speakers	Broadcasts the display's audio.

## Remote Control

The following illustration shows the display’s remote control and its buttons:

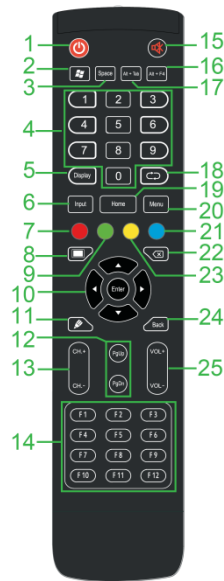

No.	Button	Description
1	Power	Turns the display on or off.
2	Windows Menu*	Performs the same action as the Windows key on a PC keyboard.
3	Spacebar*	Performs the same action as the spacebar on a PC keyboard.
4	Numeric Keypad	Numeric input buttons.
5	Display Information	Displays the current channel/input information.
6	Input Source	Opens the input source menu.
7	Lock/Unlock Display Buttons and Touchscreen	Disables/Enables both the buttons located on the front of the display and the display’s touchscreen.
8	Blank Screen	Makes the screen display a monochromatic screen.
9	Lock/Unlock Display Buttons	Disables/Enables the buttons located on the front of the display.
10	Navigation Buttons	Navigates between various applications and menus shown on screen.
11	Quick Draw	Launches the displays drawing tools. See the Tools section for more information.
12	Page Up/Down*	Performs the same action as the Page Up/Down buttons on a PC keyboard.
13	Function Buttons	Functional buttons.
14	F1 - F12*	Performs the same action as the F1 - F12 keys on a PC keyboard.
15	Mute	Disables the display’s audio.
16	Alt+F4 (Close Window)*	Performs the same action as the Alt+F4 key combination on a PC keyboard.
17	Alt+Tab (Switch Window)*	Performs the same action as the Alt+Tab key combination on a PC keyboard.
18	Function Button	Functional button.
19	Home Screen	Returns the display to the home screen.
20	Settings Menu	Opens the OSD settings menu.
21	Freeze Screen	Freezes the screen.
22	Backspace	Deletes the entered text.
23	Lock/Unlock Touchscreen	Disables/Enables the display’s touchscreen and prevents touch gestures from working.
24	Back	Returns to the previous screen.
25	Volume +/-	Adjusts the display’s audio level.

\*Only functional when an OPS unit running Windows is installed into the display.

## Installing Batteries

Before using the display's remote control you must first install the two AAA batteries included with the display.

1. Open the battery compartment cover on the remote control.

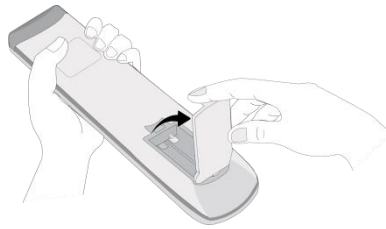

2. Insert the batteries ensuring that the + and - terminals on the battery match their corresponding terminals in the battery compartment.

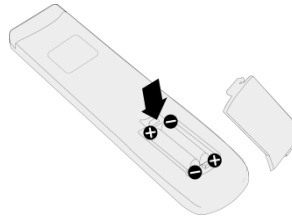

**!** *WARNING: Failure to install the correct batteries in the correct orientation may result in damage or possibly injury.*

3. Replace the battery compartment cover on the remote control.

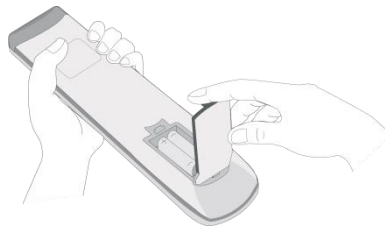

## Remote Control Usage

When using the remote control ensure that the remote control is pointed at the IR sensor at the front of the display within a range of 8 meters distance and 30-degrees to the left and right of the IR sensor.

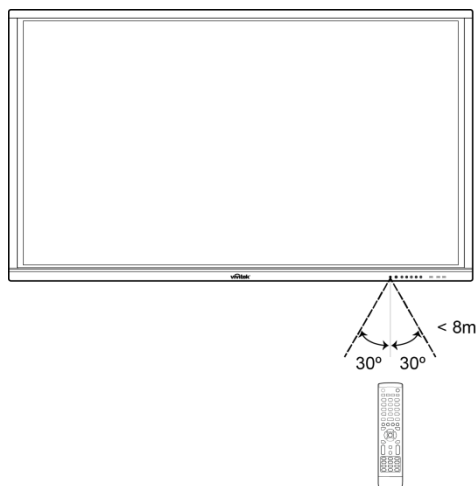

# Installing the Wall Mount

Before installing the wall mount ensure the following:

- Installation should only be done by a certified professional.
- Maximum wall mount kit load capacity:150kg (330lbs).
- When setting the display down to install the wall mount, place it face down on a flat and stable surface covered by a protective sheet or cloth and a table cushion as shown in the illustration provided. DO NOT place the display on an uncovered surface.

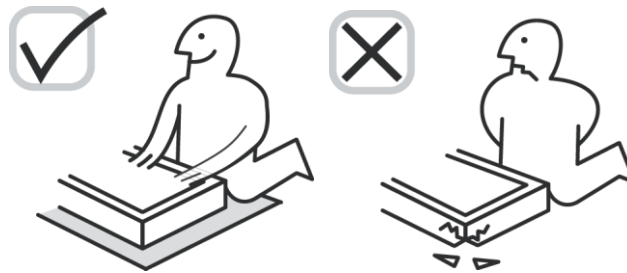

- Ensure that all the following parts are included in the wall mount kit:

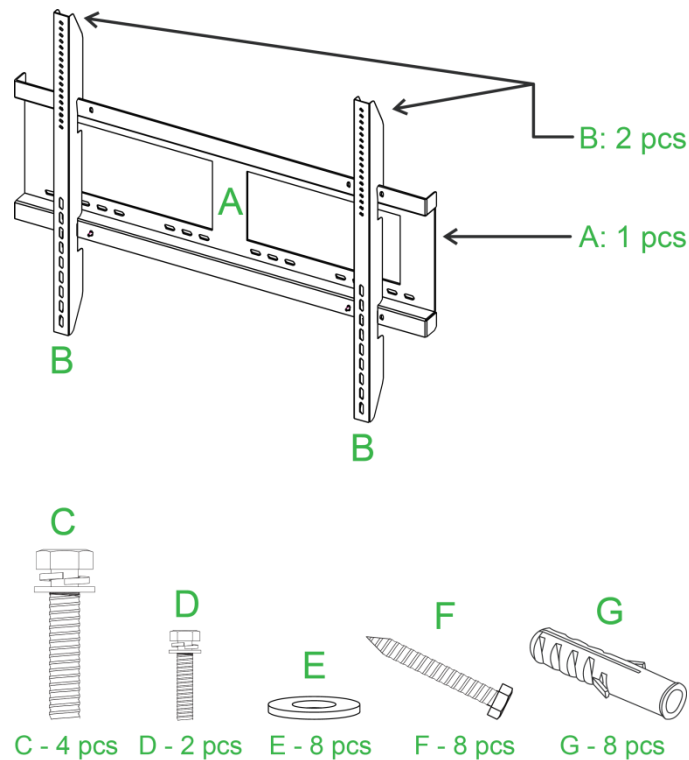

Letter	Item	Quantity
A	Wall Mount Frame	1
B	Wall Mount Brackets	2
C	Bracket Screws	4
D	Frame Screws	2
E	Wall Screw Washers	8
F	Wall Screws	8
G	Anchor Screws	8



To mount NovoTouch onto a wall follow the instructions below:

**NOTE:** This display only supports landscape display orientation. Do not mount in portrait display orientation or mount facing up or facing down.

1. Install the two (B) the wall mount brackets onto the display using the four (C) bracket screws.

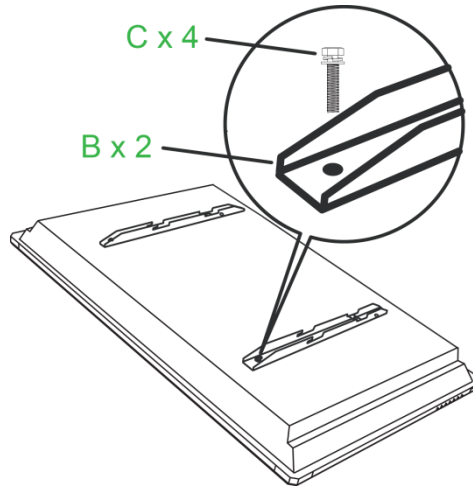

2. Install the eight (G) anchor screws into the wall you want to mount NovoTouch on.

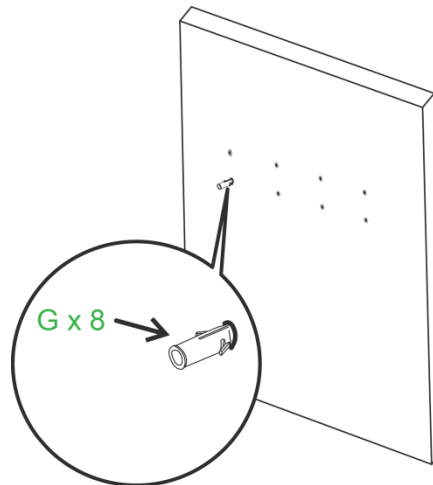

3. Install the (A) wall mount frame onto the wall by securing the eight (F) wall screws and (E) washers to the anchors.

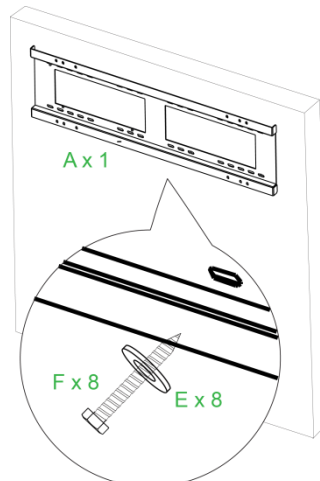

4. Mount the displays' wall mount brackets onto the wall mount frame.

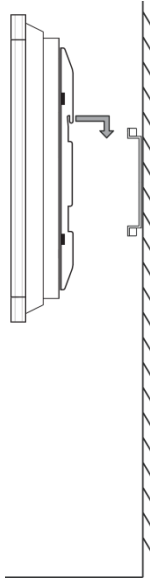

5. Secure the wall mount brackets to the frame using the two (D) frame screws.

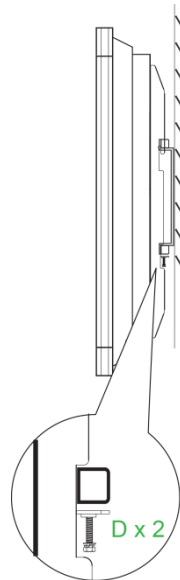

# Installing the VKA05 OPS Module

Before you begin using the display it is suggested that you install the VKA05 OPS Module first. If you do not install the VKA05 OPS module before you begin using the display, the display will not have all the functions available for use. To install the VKA05 OPS module follow the instructions below:

1. Remove the 2 screws securing the slot cover onto the display, and then remove the slot cover.

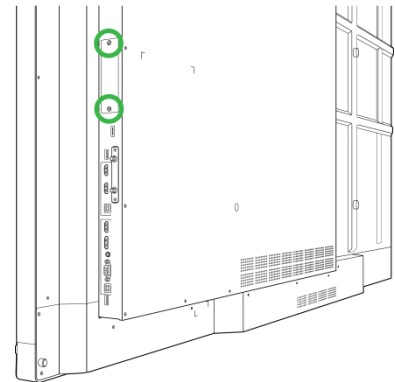

2. Slide the OPS module into the OPS slot.

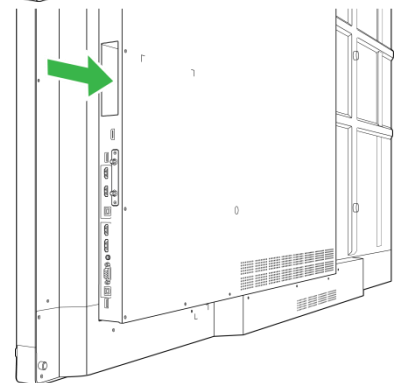

3. Tighten the two captive screws on the OPS module until the module is properly secure in the display.



4. Install the antenna onto the connector on the OPS module.

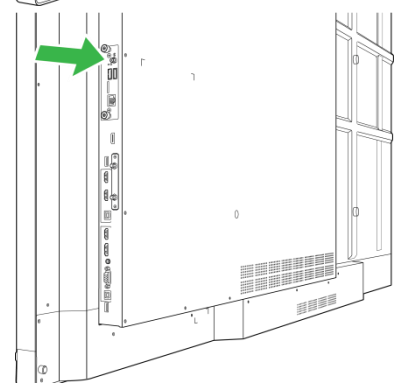

# Connections

This section describes the connections available for the various ports located on either the right or bottom side of the NovoTouch display.

**NOTE:** It is suggested that you make any connections prior to powering on the display.

## HDMI-In (1.4/2.0)

The HDMI-In ports connects to various devices such as Blu-Ray/DVD players, set-top boxes, digital media players, computers, and other sources to broadcast video and audio on the NovoTouch. When connecting a device to the HDMI-In port:

- Use an HDMI cable with a standard Type-A HDMI connector.
- Select the corresponding HDMI input in the input source menu on the NovoTouch. See the Switching Input Source section for more information on selecting input sources.

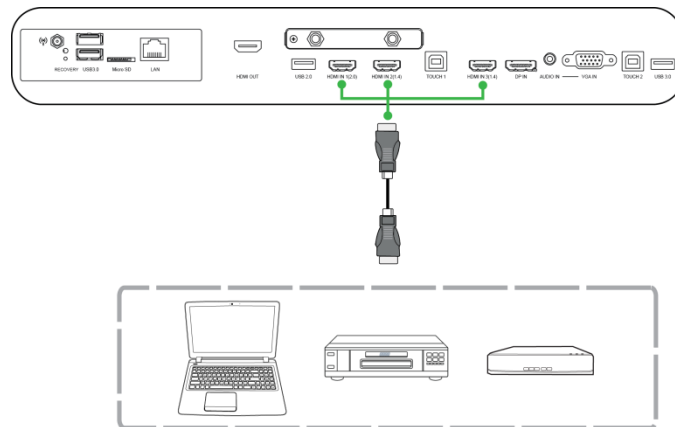

## DisplayPort-In

The DisplayPort-In port connects to computers to broadcast video and audio on the NovoTouch. When connecting a computer to the HDMI port:

- Use a standard DisplayPort cable.
- Select the corresponding DisplayPort input in the input source menu on the NovoTouch. See the Switching Input Source section for more information on selecting input sources.

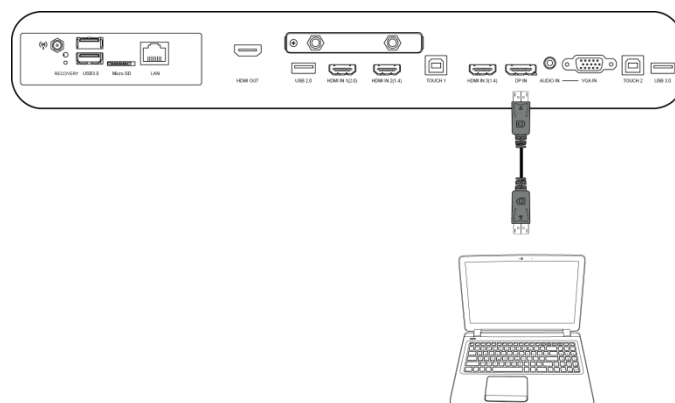

## VGA-In

The VGA-In port connects to mainly computers to broadcast video on the NovoTouch. When connecting a device to the VGA-In port:

- Use a standard VGA cable.
- Select the corresponding VGA input in the input source menu on the NovoTouch. See the Switching Input Source section for more information on selecting input sources.
- If you want the NovoTouch to also broadcast audio from the connected devices, connect an audio cable from the audio out jack of the source to the audio in jack of the NovoTouch, as described in the Audio-In section below.

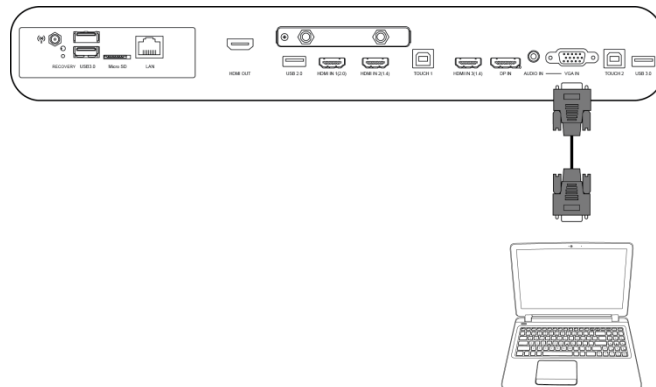

## Audio-In

The Audio-In jack is used particularly for connections that feature video-only streams (such as a VGA connection) by connecting to the audio out jack of the video source to broadcast the audio from that source. When connecting a device to the Audio-In port:

- Use a standard 3.5mm audio cable.

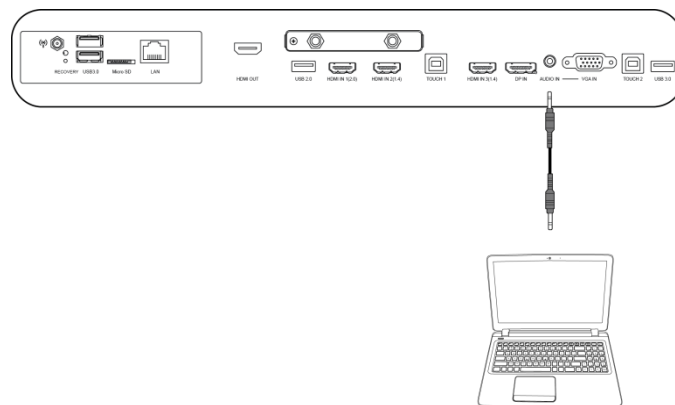

## LAN (RJ-45)

The LAN (RJ-45) port connects to a router or a hub to allow the NovoTouch to access the internet. When connecting a router to the LAN port:

- Use a standard Ethernet cable.

**NOTE:** Only the LAN port on the right side is functional on the NovoTouch. DO NOT connect to the LAN port located on the bottom of the NovoTouch.

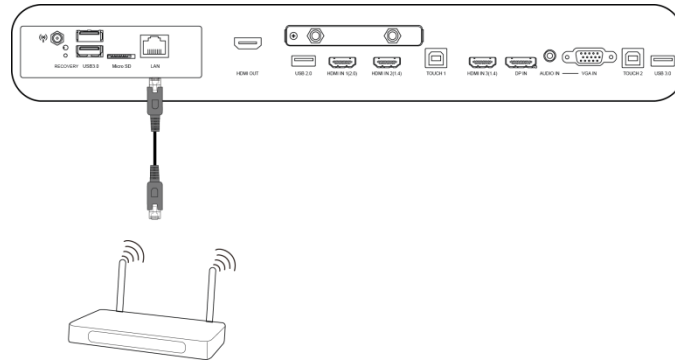

## Touch

The touch port allows you to connect a computer (via any of its USB ports) to the NovoTouch and use the touchscreen on the NovoTouch to control the computer’s on screen interface. When connecting a computer to the touch port:

- Use a Type-A to Type-B USB cable.
- Ensure that a video connection for the computer is made and the corresponding input source is selected in the input source menu, so that the touchscreen is able to show the computer’s interface.
- Allow the computer to install any necessary drivers.

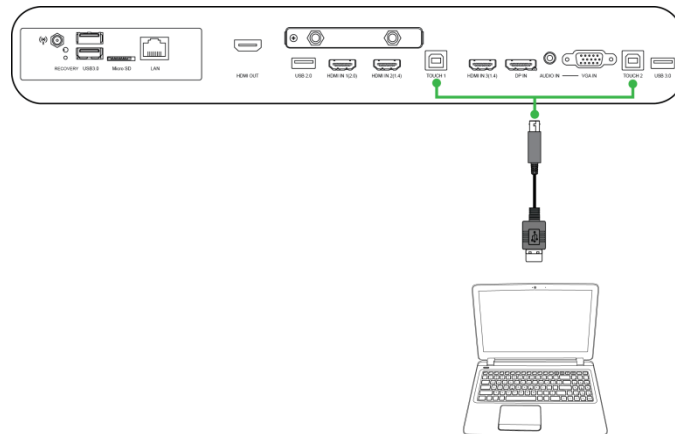

## AV-In

The AV-In port connects to various devices such as DVD players, set-top boxes, and other sources to broadcast analog video and audio on the NovoTouch. When connecting a device to the AV-In port:

- Use a 3-to-1 composite/RCA cable or corresponding converter cable.
- Select the corresponding AV input in the input source menu on the NovoTouch. See the Switching Input Source section for more information on selecting input sources.

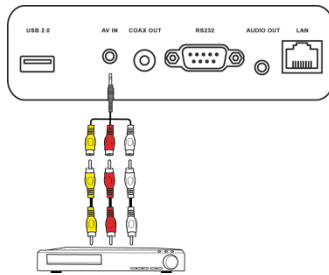

## RS-232

The AV In port connects to a computer or server to provide data and control signals to the NovoTouch. When connecting a device to the RS-232 port:

- Use a standard RS-232 cable.

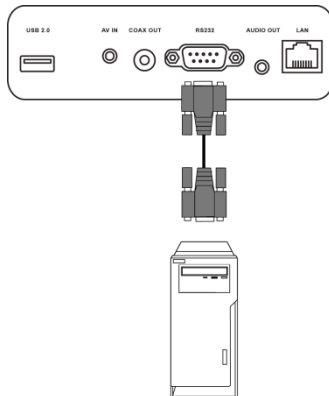

## USB (2.0/3.0)

The USB ports allow you to connect USB flash drives for direct playback of stored media, as well as USB devices such as a mouse or keyboard for easier navigation of the NovoTouch’s interface. When connecting a USB flash drive:

- Launch the Finder app to view the media files stored on the flash drive. See the Finder section for more information.

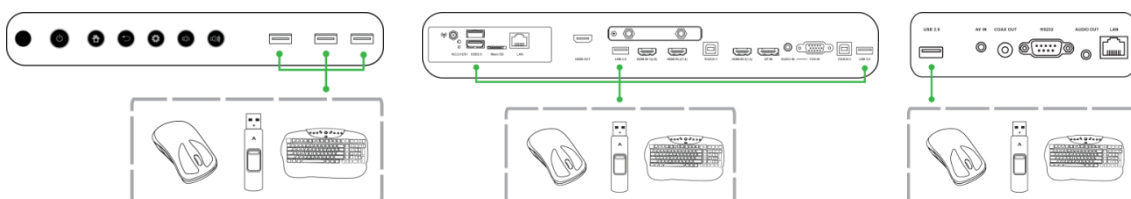

## microSD

The microSD card slot allows you to insert a microSD card for direct playback of stored media. When a microSD card is inserted:

- Launch the Finder app to view the media files stored on the card. See the Finder section for more information.

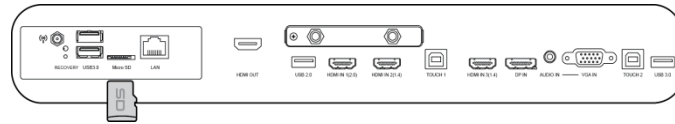

## HDMI-Out

The HDMI-Out port connects to the HDMI in port on other displays or projectors to duplicate or extend the video shown on the NovoTouch on the connected display/projector. When connecting another display device to the HDMI-Out port:

- Use a standard HDMI cable.
- Select the corresponding HDMI input on the second display.

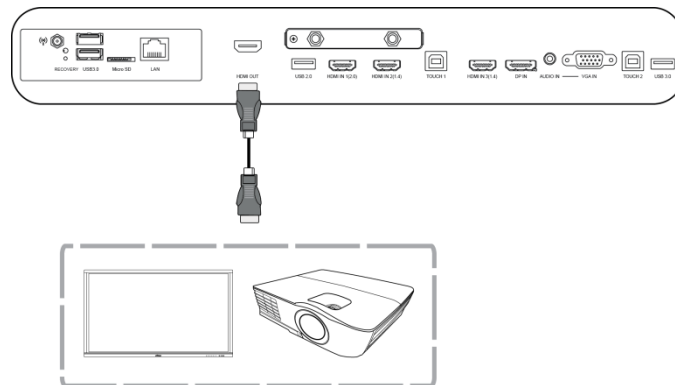

## Audio-Out

The Audio-Out jack connects to external speakers to broadcast the audio from the NovoTouch. When connecting external speakers to the Audio-Out jack:

- Use a standard 3.5mm audio cable.

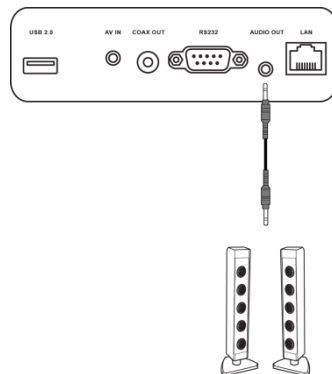



## Coax-Out

The Coax-Out jack connects to external speakers to broadcast the audio from the NovoTouch. When connecting external speakers to the Coax-Out jack:

- Use a standard coaxial cable.

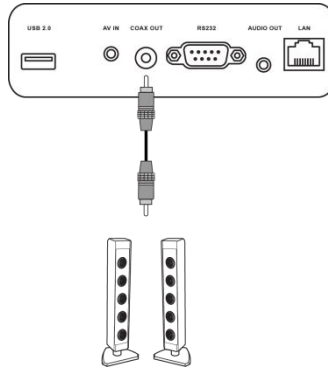

# Getting Started

## Powering the Display

After mounting/installing the NovoTouch in the desired location you must supply power to the display using the following steps:

1. Plug the supplied power cable into the display and a power source.

**NOTE:** Only use the power cable provided in the packaging with the display.

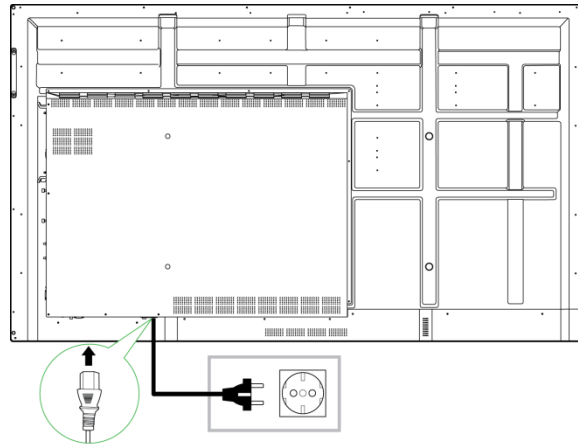

2. Turn the power switch located at the bottom of the display on.

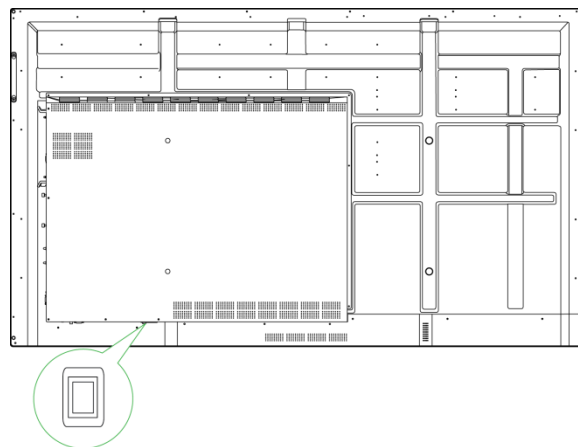

3. Press the power button on the display or the remote control to power on the display.

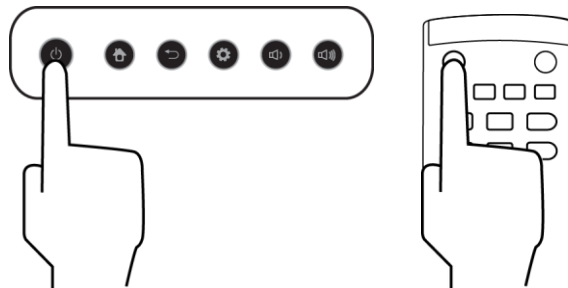

## Switching Input Source

After making a video input connection, open the input source menu to select which input source to show on the display. To open the input source menu choose one of the following methods:

- Press the Settings button located on the front side of the display

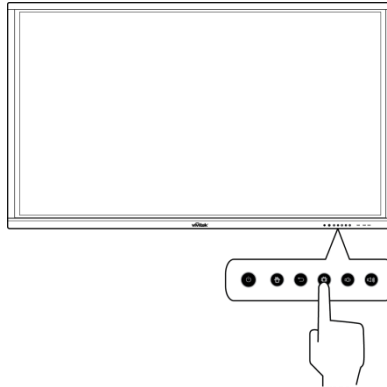

- Press the **Input** button on the remote control.



- Touch and hold the bottom of the touchscreen then swipe up.



- Tap the **Input** menu shortcut located on the home screen.

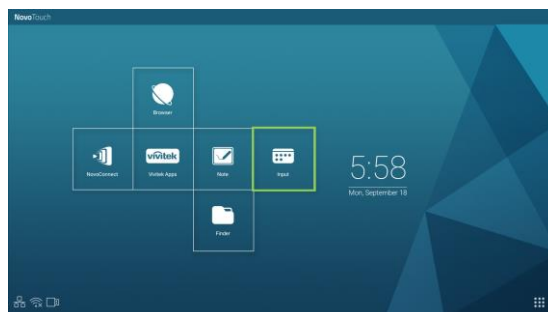

Once the input source menu is open select the video input you want to show on the display. Video inputs with a blue dot underneath indicate video inputs that are currently connected.

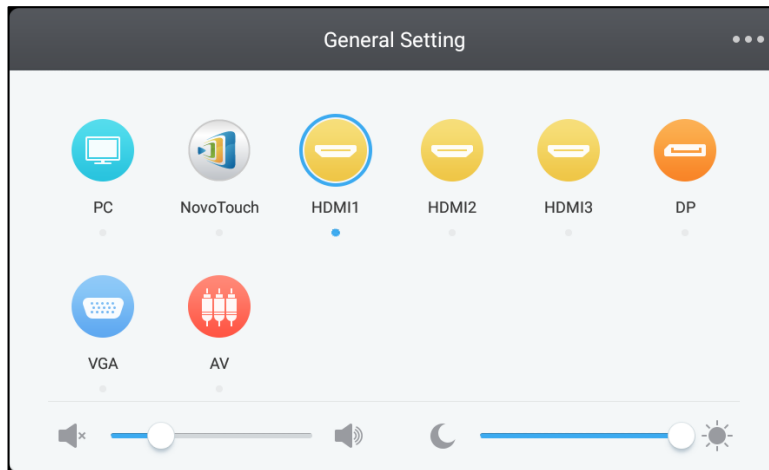

*NOTE: If no video input source is available you can select NovoTouch to enter the NovoTouch user interface described in the Using the Display section.*

## Setting up an Internet Connection

NovoTouch is able to connect to the internet using one of the following methods:

- A wired connection via the RJ-45 port, see the LAN (RJ-45) section for more information.
- A Wi-Fi connection.

### Setting up a Wi-Fi Connection

To set up a Wi-Fi connection:

1. Select **Wi-Fi** in the **Settings** menu.

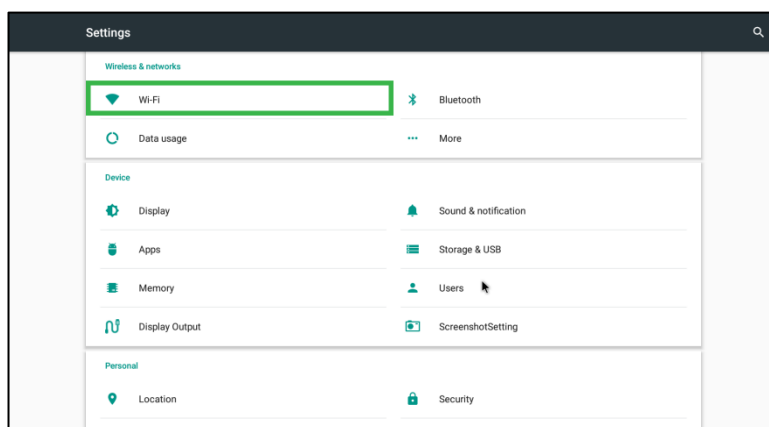

2. Turn the Wi-Fi switch on in the **Wi-Fi** menu.

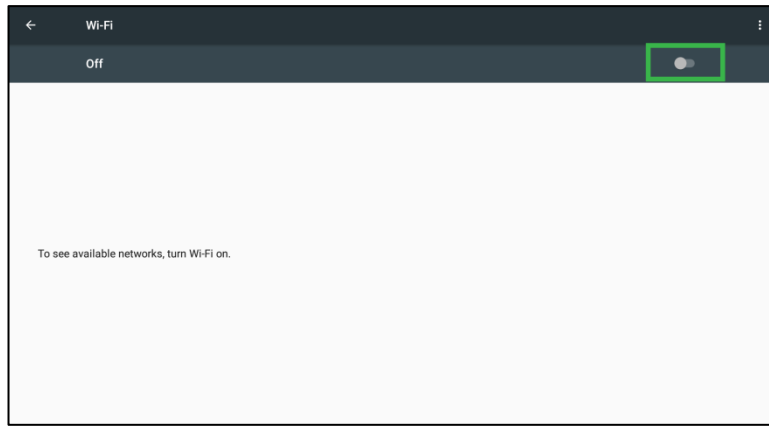

3. Select the Wi-Fi access point/router that you want NovoTouch to connect to.

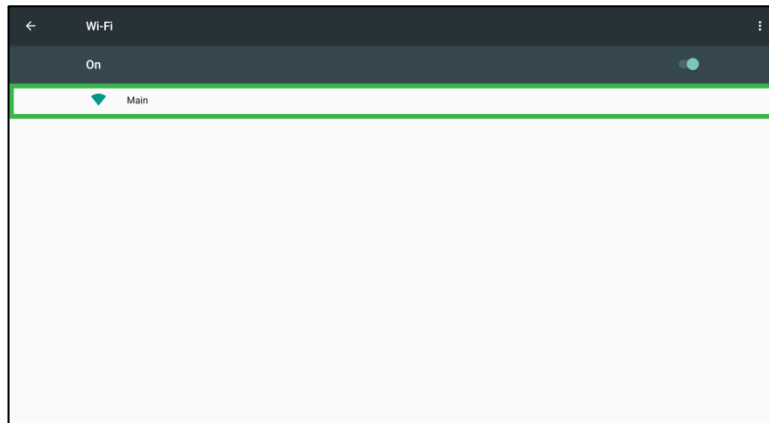

4. Enter a security password if necessary.

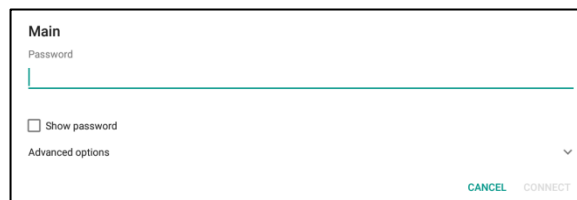

## Display Settings

The display settings menu is an On-Screen Display (OSD) menu which allows you to configure various video/audio related settings for the display. To open the display settings menu choose one of the following methods:

- Open the input source menu, and then select **•••** at the top left corner of the input source menu.



- Press the **Menu** button on the remote control.



The display settings menu includes the following for sub-menus:

- Audio
- Screen
- Display
- Adjust

## Audio

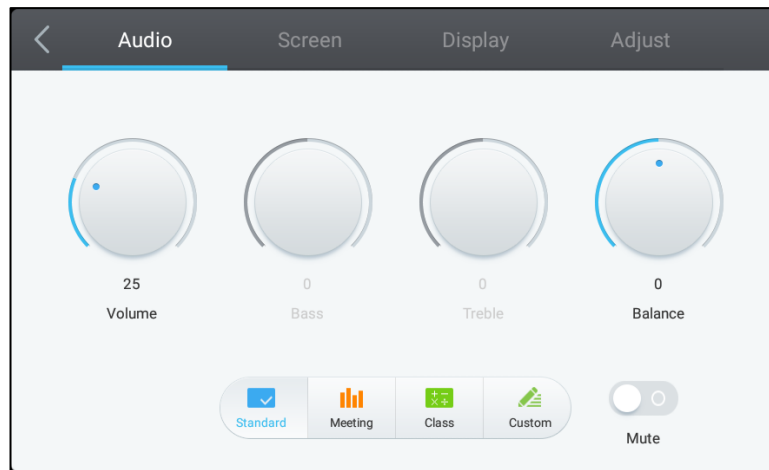

The **Audio** settings menu allows you to adjust the following settings:

Item	Description
Volume	Adjusts the volume level for the display.
Bass	Adjusts the low-frequency audio level for the display.
Treble	Adjusts the high-frequency audio level for the display.
Balance	Adjusts the left/right audio balance for the display.
Preset Settings	Provides various preset audio settings for the display. The available settings include: <b>Standard</b> , <b>Meeting</b> , <b>Class</b> , and <b>Custom</b> .
Mute	Disables the display's audio.

## Screen

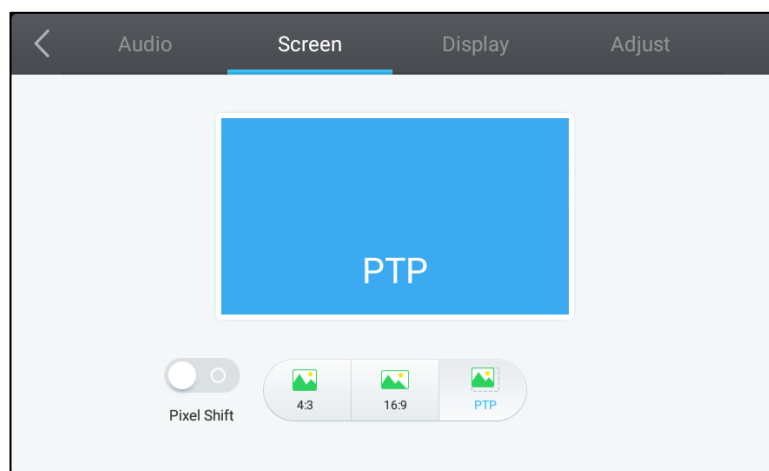

The **Screen** settings menu allows you to adjust the following settings:

Item	Description
Pixel Shift	Enables/Disables pixel shift, which is a tool to prevent image burn-in by periodically moving the video frame so there are no static image.
4:3	Sets a 4:3 screen ratio for video.
16:9	Sets a 16:9 screen ratio for the video.
PTP (Pixel-To-Pixel)	Shows the video without scaling it, such that each pixel of the video correlates with a single pixel on the monitor.

## Display

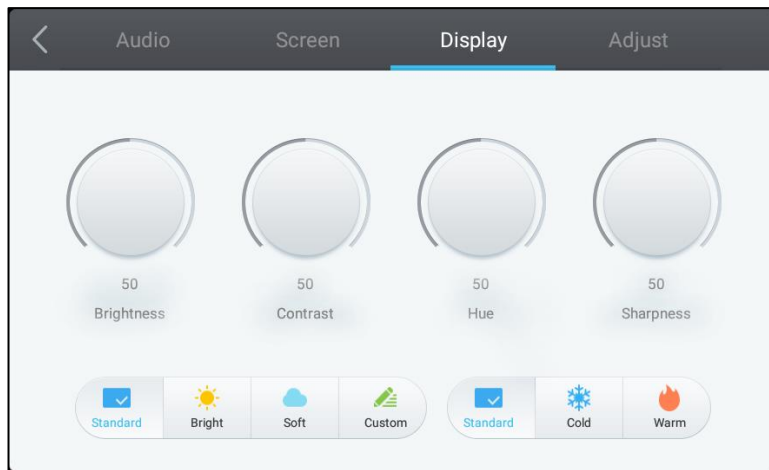

The **Display** settings menu allows you to adjust the following settings:

Item	Description
Brightness	Adjusts the brightness level for the display.
Contrast	Adjusts the contrast level for the display.
Hue	Adjusts the hue level for the display.
Sharpness	Adjusts the sharpness for the display.
Preset Settings	Provides various preset video settings for the display. The available settings include: <b>Standard</b> , <b>Bright</b> , <b>Soft</b> , <b>Custom</b> , <b>Cold</b> , and <b>Warm</b> . <i>NOTE: <b>Bright/Soft/Custom</b> and <b>Cold/Warm</b> settings can be set independent of each other.</i>

## Adjust

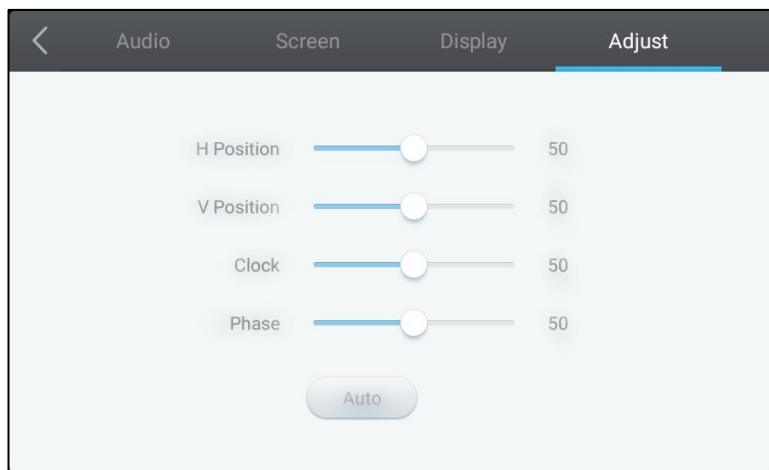

The **Adjust** settings menu allows you to adjust the following settings:

Item	Description
H Position	Adjusts the horizontal position of the video.
V Position	Adjusts the vertical position of the video.
Clock	Adjusts the pixel clock setting for the display.
Phase	Adjusts the phase setting for the display.
Auto	Allows the display to set the above settings automatically.



# Using the Display

## Home Screen

When NovoTouch is powered on and no video source is selected or if the **NovoTouch** button is selected in the input source menu, the NovoTouch home screen will be shown by default. The home screen is the main user interface for NovoTouch from where you are able to launch the following key apps installed on NovoTouch, as well as a set of touch-based tools:

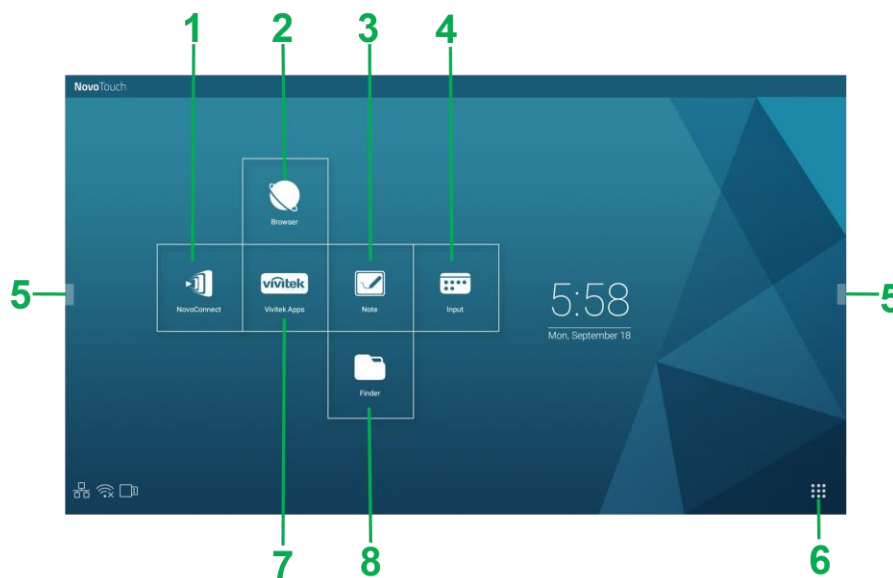

No.	Item	Description
1	NovoConnect App	Opens the NovoConnect app which allows users to project the screens of their device (PC, tablet or smartphone) on NovoTouch wirelessly for presentations and collaborative projects.
2	Browser	Opens the web browser app.
3	Note	Opens the sketchpad app.
4	Input	Opens the input source menu.
5	Tools Menu	Opens a menu of quick interactive tools for the touchscreen. <i>NOTE: The tools menu is also accessible when any app is opened on NovoTouch.</i>
6	All Apps	Opens a menu of all the apps installed on NovoTouch.
7	Vivitek Apps	Manage downloads, updates and access to the Vivitek Apps.
8	Finder	Opens the file navigation app.

The home screen for NovoTouch is non-configurable, but app shortcuts and widgets can be added to additional screens on the interface by touching and holding the touchscreen until the widgets and shortcuts selection screen appears.

See the following sections for more information on the various apps and tools located on the home page.

## NovoConnect

NovoConnect is the app that allows users to wirelessly connect their PCs, Macs, iPads/iPhones, or Android tablets/smartphones to NovoTouch and project their device’s screen onto NovoTouch’s touchscreen in a collaborative presentation session.



To wirelessly connect your device to NovoConnect and start a presentation session, follow the steps below:

1. Download and install the presentation software needed on your device based on the following table:

Type of Device	Software Needed	Download Location
PC / Mac	Desktop Streamer	www.vivitekcorp.com
iPad / iPhone	NovoPresenter	Google Play Store
Android Tablet / Smartphone	NovoPresenter	iOS App Store

2. If NovoTouch is connected to Wi-Fi: In your device’s Wi-Fi menu connect to the same Wi-Fi network that NovoTouch is connected to.

If NovoTouch is not connected to Wi-Fi: In your device’s Wi-Fi menu connect to the SSID displayed in the top right corner of the NovoConnect home page.

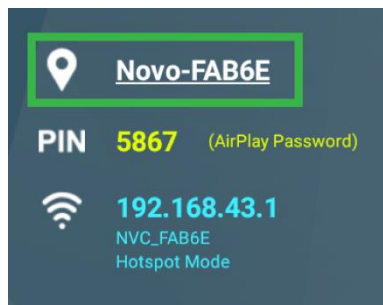

3. Launch Desktop Streamer or NovoPresenter on your device.

4. Enter the IP address and PIN displayed in the top right corner of the NovoConnect home page into the login menu of Desktop Streamer or NovoPresenter.

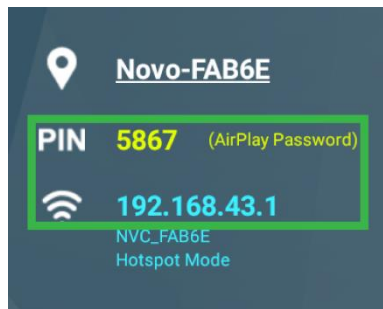

5. The first user who logs into the presentation session will automatically see their device’s screen projected on NovoTouch’s touchscreen. Subsequent users can also log in using the same login information.

*NOTE: For subsequent users, the IP address and PIN information can be viewed on the login page of the first user.*

For more information on NovoConnect, Desktop Streamer and NovoPresenter, including full descriptions of their various functions and options, download the NovoConnect user manual from the Vivitek website.

## Browser

The Browser app allows you to browse the internet on the NovoTouch after connecting the display to an internet connection via either an Ethernet connection or a wireless connection. See the LAN (RJ-45) section or the Setting up a Wi-Fi Connection section for more information on connecting the display to the internet.

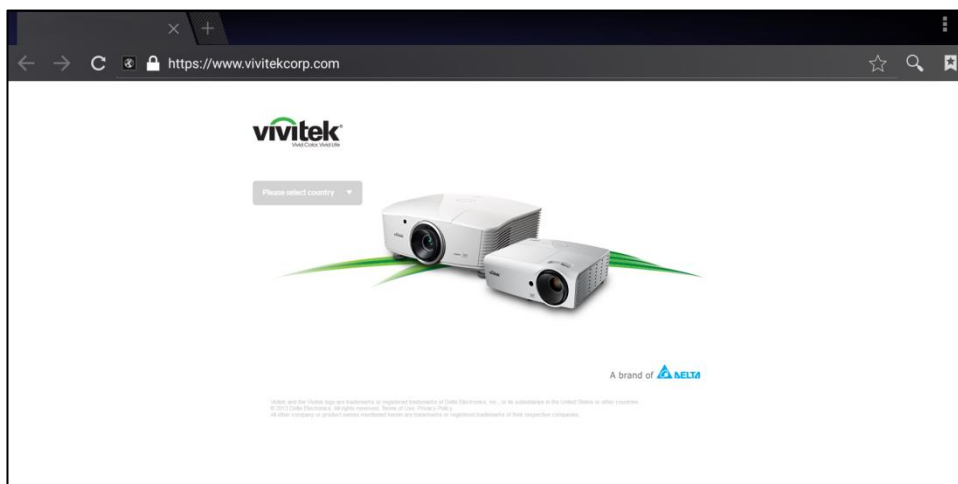

## Note

The Note app allows you to use the touchscreen as a sketchpad to freehand draw on the display using touch gestures.

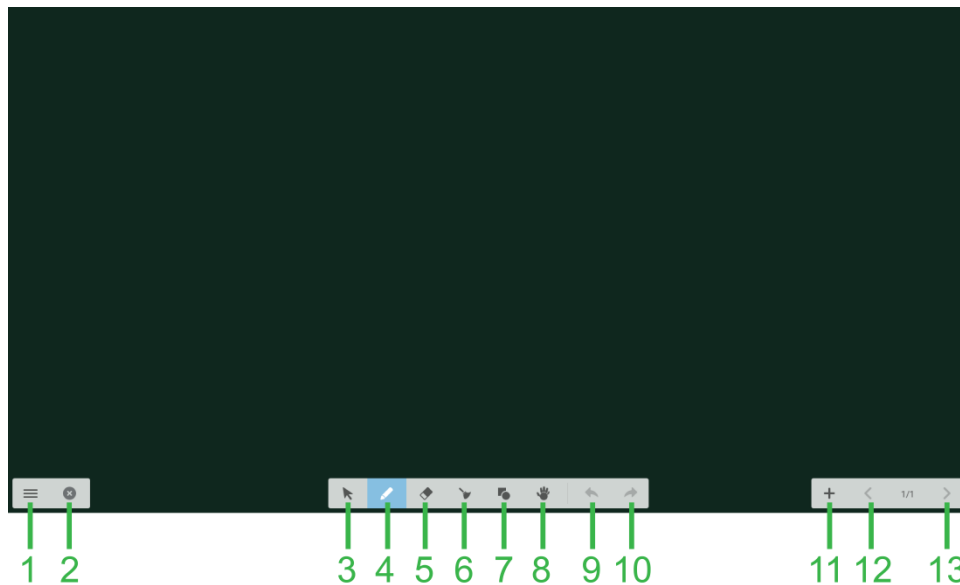

No.	Item	Description
1	File Menu	Allows you to save/open/start new drawings, import/export images, and perform other file related actions.
2	Close	Closes the Note app.
3	Cursor	Allows you to select and move items drawn on the touchscreen.
4	Drawing Tool	Allows you to draw as well as configure the size and color of the drawing tool you want to use.
5	Eraser Tool	Allows you to erase items drawn on the touchscreen.
6	Clear All Tool	Allows you to erase all items drawn on the touchscreen at once.
7	Shapes Tool	Allows you to add lines and shapes on the drawing.
8	Zoom Tool	Allows you to change the scale level of the drawing.
9	Undo	Cancel the previous action.
10	Redo	Restores the previous action.
11	Add Page	Adds a new page to the drawing.
12	Previous Page	Jumps to the previous page.
13	Next Page	Jumps to the next page.

## System Settings

The system settings menu allows you to configure or view various settings related to the system/software for NovoTouch.

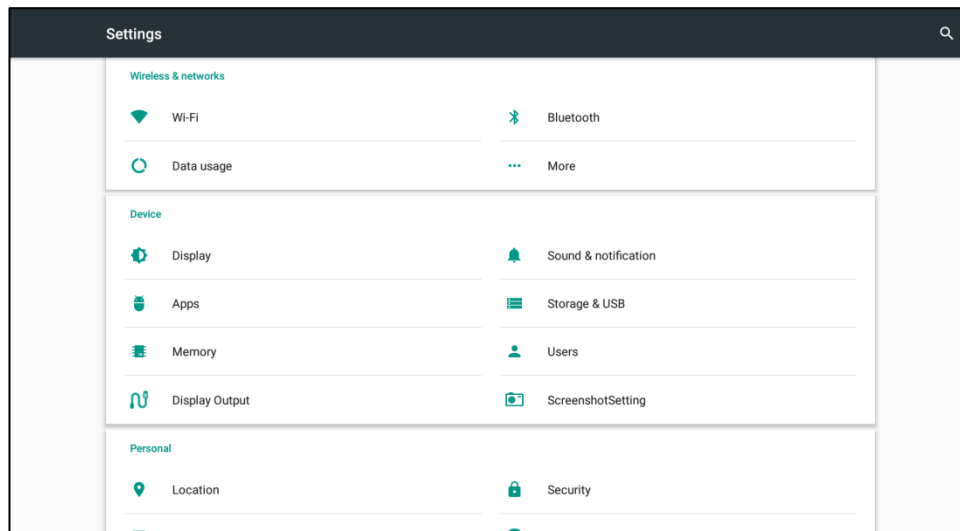

## Finder

The Finder app allows you to navigate the files and folders saved locally on NovoTouch as well as any storage devices connected to ports.

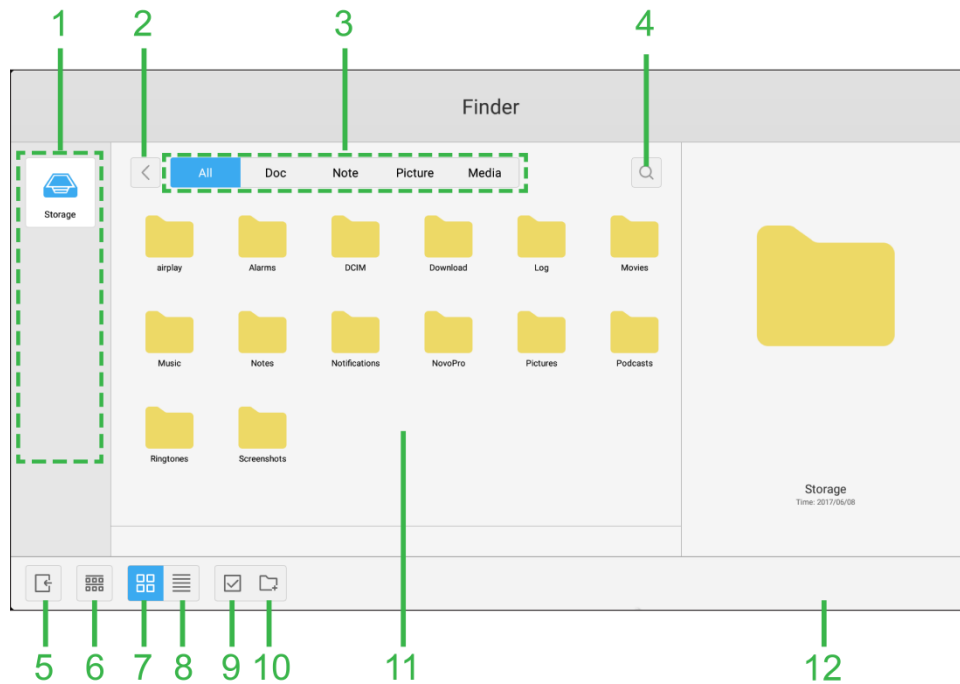



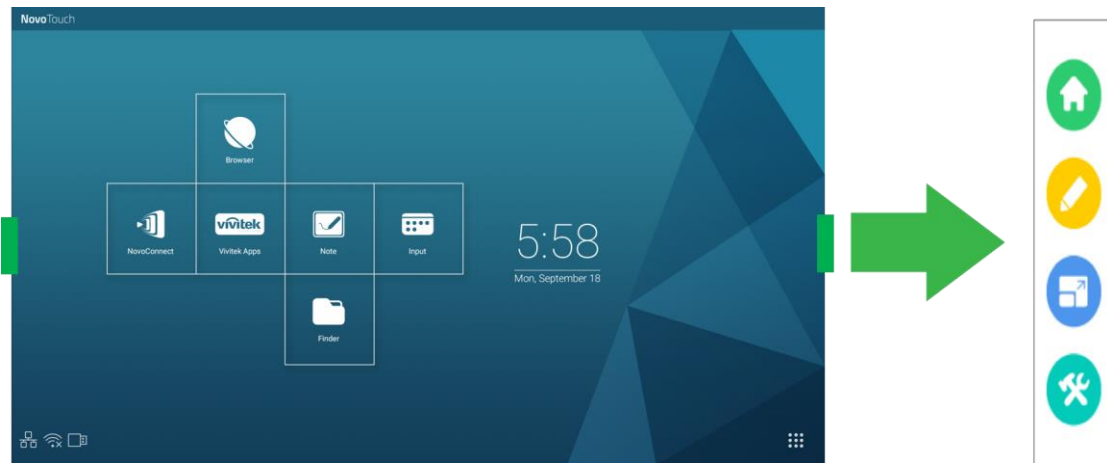

No.	Item	Description
1	Storage Devices List	Displays the various storage devices available to navigate in the app, select a storage device to navigate.
2	Previous	Jumps to the previous folder opened in the navigation window.
3	File Type	Allows you to view files based on file type.
4	Search	Allows you to search for specific files.
5	Exit	Exits the Finder app.
6	Sort	Sorts the files either by name, type, size, or time.
7	Thumbnail	Changes the navigation window to thumbnail view.
8	List	Changes the navigation window to list view.
9	Select	Allows you to select multiple files in the navigation window. Once files are selected a file management menu will open allowing you to copy, paste, cut, delete, etc. the files selected.
10	Select All	Selects all files in the navigation window. Once files are selected a file management menu will open allowing you to copy, paste, cut, delete, etc. the files selected.
11	Navigation Window	Navigate through file folders in this window.
12	File Details	Displays details for the file selected in the navigation window.

## Tools

The NovoTouch user interface features a set of interactive tools that are accessible from any screen/app in the interface by touching the arrow button on the left and right side of the touchscreen, as seen in the image below.



The tools include the following items:

Item	Description
	Returns the display to the home screen.
	Launches the quick annotation tool which allows you to create annotations directly on the image shown on the display.
	Launches the freeze screen tool which allows you to freeze the image shown on the display and then zoom in or out on the frozen image.
	Opens menu of additional interactive tools including the following: <ul style="list-style-type: none"> <li>• Spotlight: Illuminates only a portion of the image shown on the display.</li> <li>• Countdown: Turns the touchscreen to an interactive countdown clock.</li> <li>• StopWatch: Turns the touchscreen into an interactive stopwatch.</li> <li>• AirClass: Turns the touchscreen into an interactive voting tool.</li> </ul>

# Cleaning the Display

When cleaning the NovoTouch display, please ensure you follow the instructions below to prevent damage to the display and its panel.

- Before you begin cleaning the display, ensure that it is powered off and unplugged from the power source. Then remove any styluses, pens, or accessories attached to the display.
- Do not use any chemicals on the panels.
- Do not use anything abrasive to wipe the display, use a clean soft, lint-free cloth instead to wipe the display.
- Do not spray water directly on the display, fill a spray bottle with water and spray directly on to the cleaning cloth instead. After wiping the display with the wet cleaning cloth use another clean soft, lint-free cloth to dry the display.
- Make sure all dust, debris, and smudges are removed from the display, ensuring that the corners and edges are also wiped clean.
- When wiping the display use a circular motion as seen in the image below:

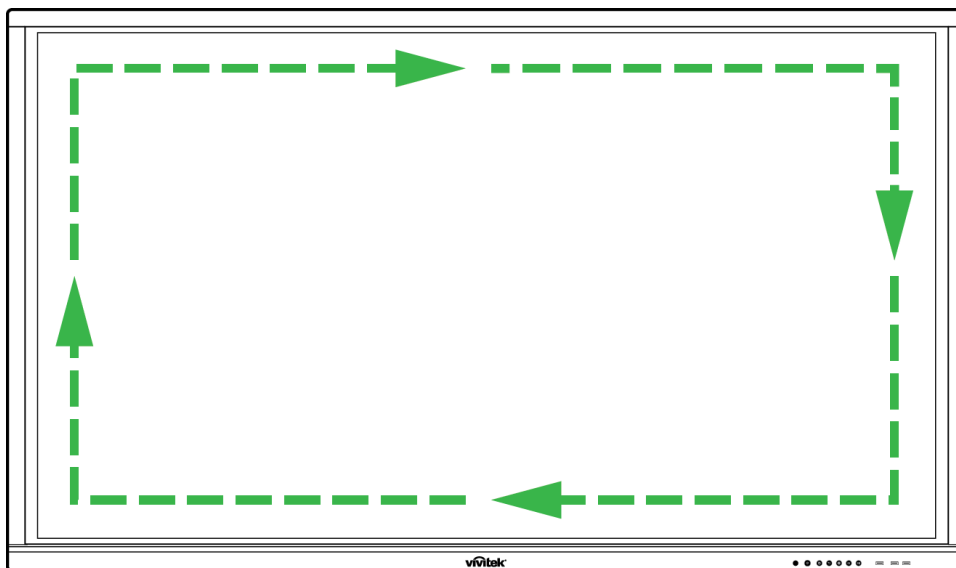



# Specifications

Model Name		NovoTouch LK6530i	NovoTouch LK7530i	NovoTouch LK8630i
Display Type/Size/Technology		65" Backlit LED (IPS Panel)	75" Backlit LED (IPS Panel)	86" Backlit LED (IPS Panel)
Brightness (Typical/Minimum)		350cd/m <sup>2</sup> /300cd/m <sup>2</sup>		
Contrast Ratio (Typical)		1,200:1		
Native Resolution		4K Ultra-HD (3840 x 2160)		
Viewing Angle (H/V)		178°/178°		
Aspect Ratio		16:9		
Response Time (MS)		8ms (Typ)		
Touch Technology		Infrared Touch		
Touch Points (Writing/Touch)		10 Points/20 Points		
Display Orientation		Landscape (No Portrait mode support)		
Operating System Version (with VKA05 Installed)		Android™ v6.0		
Connectivity	Input	Display	HDMI v2 (x1), HDMI v1.4 (x2), DisplayPort (x1), VGA-In (x1)	
		Audio	Audio-In (3.5mm) (x1), AV-In (x1)	
	Output	Display	HDMI-Out (1080P) (x1)	
		Audio	Audio-Out (3.5mm) (x1), Coaxial-Out (RCA) (x1)	
	Internet		LAN (RJ45) (x1)	
	Control		RS232 (x1)	
	USB	Front	USB 2.0 (x2), USB 3.0 (x1)	
		Side	USB 2.0 (x1), USB 3.0 (x1), USB Type B (x2)(For Touch Port)	
		Bottom	USB 2.0 (x1)	
NovoPro Android Module (Slot 1)		Standard (120pin)		
PC OPS Module (Slot 2)		Optional (120pin)		
Internal Speakers		12W (x2) (Stereo)		
Dimensions (L x H x D) (Estimated)		1,521 x 915 x 99mm (59.9" x 36" x 3.9")	1,762 x 1,034 x 100mm (69.4" x 40.7" x 3.9")	1,988 x 1,178 x 99.6mm (78.3" x 46.4" x 3.9")
Weight (Estimated)		47kg (104lbs)	60kg (132lbs)	78kg (172lbs)
Available Color		Black		
Standard Accessories		AC Power Cord, VGA Cable, USB Cable, Audio Cable, Stylus (x3), Remote Control, Wall Mount Kit, Documentation Kit		

# Troubleshooting

## If the display does not function normally

Remote control failure	1	Check whether there are other objects between the remote control and the IR sensor window, thus leading to remote control failure.
	2	Check whether the battery electrodes in the remote control are in the correct orientation.
	3	Check whether remote control needs to replace its batteries.
Machine automatically shuts down	1	Check whether sleep is set or not.
	2	Check whether there has been a sudden power outage.
	3	Check whether there is a signal (the display may power off after a period of inactivity).

## PC mode issues

Signal is out of range	1	Check whether the display is setup correctly.
	2	Check whether the resolution is the best resolution.
Background has vertical lines or streaks	1	Select auto correction in the OSD settings menu.
	2	Adjust the clock and phase values in the OSD settings menu.
Image lacks color or the color is incorrect	1	Check whether the video cables are well connected or have quality problems.
	2	Adjust brightness or contrast values in the OSD settings menu.
The display format is not supported	1	Select auto correction in the OSD settings menu.
	2	Adjust the clock and phase values in the OSD settings menu.

## Touch functionality issues

Touch function invalid	1	Check whether the touchscreen driver is installed.
	2	Check whether the size of point of contact is comparable to finger.
Touch position is not correct	1	Check whether the touchscreen driver is installed.
	2	Check whether touch pen is facing the screen.

## Videos do not function normally

No picture and no sound	1	Check whether the machine is in a powered state.
	2	Check whether signal cable is plugged in correctly, and whether the correct input source is selected.
	3	If the display is in internal computer mode, check whether internal computer is started.
The image features horizontal or vertical stripes or image dithering	1	Check whether signal cable is plugged in correctly.
	2	Check whether other electronic equipment or power tools are placed around the machine.
No color, color is weak, or image is weak	1	Adjust brightness or contrast values in the OSD settings menu.
	2	Check whether signal cable is plugged in correctly.

## Audio does not function normally

Images is shown without sound	1	Check whether the mute button has been pressed.
	2	Press VOL + / - to adjust volume.
	3	Check whether the audio line is connected correctly.
Only one speaker has sound	1	Adjust the sound balance in the OSD settings menu.
	2	Check whether the computer's sound control panel has only set up one sound channel.
	3	Check whether audio line is connected correctly.
VGA output is shown without sound	1	Check whether the audio out jack of the external device is connected to the audio in jack.

# Appendix (RS-232 Specifications)

The following are the pin definitions for the RS-232 port:

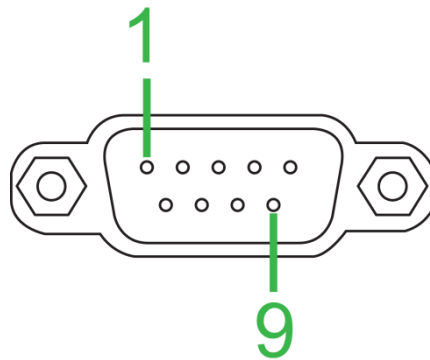

## Serial Port Settings:

Item	Value
Baud Rate	9600bps (fixed)
Data Bits	8 (fixed)
Stop Bits	1 (fixed)
Parity	None (fixed)
Stream Control	None (fixed)

## Command Format:

No.	Content	Description	Remark
1	0xAA	Head	Fixed Value
2	0xBB		Fixed Value
3	0xCC		Fixed Value
4		Main	
5		Subcommand	
6	0x00	Length	Valid data
7	checksum	Checksum	Sum from No.4 to No.6
8	0xDD	End	Fixed Value
9	0xEE		Fixed Value
10	0xFF		Fixed Value

## Code List

Function	Mode	Code	Remark
Power	ON	AA BB CC 01 00 00 01 DD EE FF	
	OFF	AA BB CC 01 01 00 02 DD EE FF	
Source	VGA1	AA BB CC 02 03 00 05 DD EE FF	
	HDMI1	AA BB CC 02 06 00 08 DD EE FF	
	HDMI2	AA BB CC 02 07 00 09 DD EE FF	
	HDMI3	AA BB CC 02 05 00 07 DD EE FF	
	PC	AA BB CC 02 08 00 0A DD EE FF	
	ANDROID	AA BB CC 02 0A 00 0C DD EE FF	
	ANDROID+	AA BB CC 02 0E 00 10 DD EE FF	
	DP	AA BB CC 02 11 00 13 DD EE FF	
Volume	000-100	AA BB CC 03 00 xx ** DD EE FF	
	MUTE	AA BB CC 03 01 00 04 DD EE FF	
	UNMUTE	AA BB CC 03 01 01 05 DD EE FF	
Aspect Ratio	16:9	AA BB CC 08 00 00 08 DD EE FF	
	4:3	AA BB CC 08 01 00 09 DD EE FF	
	PTP	AA BB CC 08 07 00 0F DD EE FF	

PC Power	ON	AA BB CC 09 01 00 0A DD EE FF	
	OFF	AA BB CC 09 00 00 09 DD EE FF	
xx = from 0 to 100, for volume Ex. Volume = 30 (Decimal) = 1E (Hex), xx = 1E and ** = 03 (Hex) + 00 (Hex) + 1E (Hex) = 21 (Hex).			
Remote Control	WIN	AA BB CC 07 0B 00 12 DD EE FF	
	Space	AA BB CC 07 46 00 4D DD EE FF	
	Alt+Tab	AA BB CC 07 1D 00 24 DD EE FF	
	Alt+F4	AA BB CC 07 1F 00 26 DD EE FF	
	NUM_1	AA BB CC 07 00 00 07 DD EE FF	
	NUM_2	AA BB CC 07 10 00 17 DD EE FF	
	NUM_3	AA BB CC 07 11 00 18 DD EE FF	
	NUM_4	AA BB CC 07 13 00 1A DD EE FF	
	NUM_5	AA BB CC 07 14 00 1B DD EE FF	
	NUM_6	AA BB CC 07 15 00 1C DD EE FF	
	NUM_7	AA BB CC 07 17 00 1E DD EE FF	
	NUM_8	AA BB CC 07 18 00 1F DD EE FF	
	NUM_9	AA BB CC 07 19 00 20 DD EE FF	
	NUM_0	AA BB CC 07 1B 00 22 DD EE FF	
	Display	AA BB CC 07 1C 00 23 DD EE FF	
	Refresh	AA BB CC 07 4C 00 53 DD EE FF	
	Input	AA BB CC 07 07 00 0E DD EE FF	
	Home	AA BB CC 07 48 00 4F DD EE FF	
	Menu	AA BB CC 07 0D 00 14 DD EE FF	
	Delete	AA BB CC 07 40 00 47 DD EE FF	
	Energy	AA BB CC 07 4E 00 55 DD EE FF	
	UP	AA BB CC 07 47 00 4E DD EE FF	
	DOWN	AA BB CC 07 4D 00 54 DD EE FF	
	LEFT	AA BB CC 07 49 00 50 DD EE FF	
	RIGHT	AA BB CC 07 4B 00 52 DD EE FF	
	ENTER	AA BB CC 07 4A 00 51 DD EE FF	
	Point	AA BB CC 07 06 00 0D DD EE FF	
	Back	AA BB CC 07 0A 00 11 DD EE FF	
	CH+	AA BB CC 07 02 00 09 DD EE FF	
	CH-	AA BB CC 07 09 00 10 DD EE FF	
	VOL+	AA BB CC 07 03 00 0A DD EE FF	
	VOL-	AA BB CC 07 41 00 48 DD EE FF	
	PageUp	AA BB CC 07 42 00 49 DD EE FF	
	PageDown	AA BB CC 07 0F 00 16 DD EE FF	
	F1	AA BB CC 07 45 00 4C DD EE FF	
	F2	AA BB CC 07 12 00 19 DD EE FF	
	F3	AA BB CC 07 51 00 58 DD EE FF	
	F4	AA BB CC 07 5B 00 62 DD EE FF	
	F5	AA BB CC 07 44 00 4B DD EE FF	
	F6	AA BB CC 07 50 00 57 DD EE FF	
F7	AA BB CC 07 43 00 4A DD EE FF		
F8	AA BB CC 07 1A 00 21 DD EE FF		
F9	AA BB CC 07 04 00 0B DD EE FF		
F10	AA BB CC 07 59 00 60 DD EE FF		
F11	AA BB CC 07 57 00 5E DD EE FF		
F12	AA BB CC 07 08 00 0F DD EE FF		
RED	AA BB CC 07 5C 00 63 DD EE FF		
GREEN	AA BB CC 07 5D 00 64 DD EE FF		
YELLOW	AA BB CC 07 5E 00 65 DD EE FF		
BLUE	AA BB CC 07 5F 00 66 DD EE FF		

## Polling Code List

Function	Code	Response	Status
Power Status	AA BB CC 01 02 00 03 DD EE FF	AA BB CC 80 00 00 80 DD EE FF	ON
		AA BB CC 80 01 00 81 DD EE FF	OFF
Volume Status	AA BB CC 03 02 00 05 DD EE	AA BB CC 82 00 xx ** DD EE FF	Volume = xx

	FF		
Mute Status	AA BB CC 03 03 00 06 DD EE	AA BB CC 82 01 00 83 DD EE FF	Mute
	FF	AA BB CC 82 01 01 84 DD EE FF	Unmute
Source Status	AA BB CC 02 00 00 02 DD EE FF	AA BB CC 81 03 00 84 DD EE FF	VGA1
		AA BB CC 81 0E 00 8F DD EE FF	ANDROID+
		AA BB CC 81 05 00 86 DD EE FF	HDMI3
		AA BB CC 81 06 00 87 DD EE FF	HDMI1
		AA BB CC 81 07 00 88 DD EE FF	HDMI2
		AA BB CC 81 08 00 89 DD EE FF	PC
		AA BB CC 81 0A 00 8B DD EE FF	ANDROID
		AA BB CC 81 11 00 92 DD EE FF	DP
		PC Status	AA BB CC 09 02 00 0b DD EE FF
AA BB CC 83 01 00 84 DD EE FF	OFF		
AA BB CC 83 02 00 85 DD EE FF	Sleep		
AA BB CC 83 03 00 86 DD EE FF	Hibernate		

# Copyright Statement

## Copyright

The user manual (including all pictures, illustrations and software) is protected by the international copyright right law. All rights are reserved. No duplication of the manual or any content included in the manual is allowed without the written consent of the manufacturer.

Vivitek is the trademark of Delta Electronics, Inc. ©All rights reserved. 2017

## Disclaimer

The information in the manual is subject to change without notice. The manufacturer does not provide any statement or warranty of the contents in the manual and clearly give up the implied warranties of merchantability and of fitness for a particular purpose. The manufacturer reserves the rights to modify the publication and change the contents of the materials at any time without notice to any person.

## About the Manual

The manual describes how to install and use the display and is applicable to the end-user. Relevant information (such as illustrations and descriptions) is put on the same page as possible as we can. The format, easy for printing, is convenient for reading and paper-saving which is beneficial to environmental protection. It is suggested printing the page you need.



**Vivitek Americas**

46101 Fremont Blvd, Fremont, CA 94538  
U.S.A.  
T: +1-510-668-5100  
F: +1-510-668-0680

**Vivitek Asia**

7F, No. 186, Ruey Kuang Road, Neihu, Taipei 11491  
Taiwan R.O.C.  
T: +886-2-8797-2088  
F: +886-2-6600-2358

**Vivitek Europe**

Zandsteen 15, 2132 MZ Hoofddorp  
The Netherlands  
T: +31-20-800-3960  
F: +31-20-655-0999  
[www.vivitekcorp.com](http://www.vivitekcorp.com)