



KV52

USER GUIDE English



TABLE OF CONTENTS

SYMBOLS	3
1. INTRODUCTION	4
2. KEY FEATURES	4
3. APPLICATIONS.....	4
4. SAFETY INFORMATION.....	5
5. UNPACKING	6
6. PACKAGING	6
7. PHYSICAL OVERVIEW.....	7
8. WIRING.....	8
9. INSTALLATION.....	9
9.1 WALL BRACKETS	9
9.2 MOUNTING THE UNIT	10
9.3 TILTING THE UNIT.....	11
9.4 JOINING TWO UNITS	12
10. SERVICE	13
11. TECHNICAL SPECIFICATIONS.....	14
12. CERTIFICATION.....	15

SYMBOLS



K-array declares that this device is in compliance with applicable CE standards and regulations. Before putting the device into operation, please observe the respective country-specific regulations!



Waste Electrical and Electronic Equipment (WEEE)
Please dispose of this product at the end of its operational lifetime by bringing it to your local collection point or recycling center for such equipment.



This symbol alerts the user to the presence of recommendations about the product's use and maintenance.



Warning: DANGEROUS VOLTAGE.
Terminals marked with this symbol carry a risk of **electric shock**, therefore external wiring connected to these terminals requires installation by a qualified professional or the use of ready-made leads or cords.



This symbol alerts the user to the presence of recommendations about product's use and maintenance.



This device complies with the Restriction of Hazardous Substances Directive.

1. INTRODUCTION

The KV52 Vyper is an ultra-flat passive speaker system comprised of eight 1" neodymium magnet transducers housed in an sleek, durable aluminum chassis. The eight closely-spaced, full-range cone drivers provide true line array characteristics: phase coherence, low distortion and focused listening in both the foreground and at a distance from the speaker.

Two included steel brackets provides an easy-to-mount option for permanent wall installations. For easier use and integration with other speakers or amplifiers, KV52 allows the user to select between two different values of impedance: 16Ω and 64Ω. At 64Ω, as many as sixteen KV52 speakers can be powered by a single amplifier channel at 4Ω, which eliminates the need of 70 V amplifiers for wider distributed installed systems.

The KV52 is able to reproduce the entire vocal frequency range with high intelligibility, starting from 150 Hz. Integrating an ultra-compact K-array subwoofer powered by KA amplifier set with specific presets optimized for the KV52 assures excellent coverage of the entire musical frequency range.

All KV52 Vyper components are designed by the K-array R&D Department and custom made under the K-array quality control system.

2. KEY FEATURES

- Unique performance-to-size ratio
- Multiple 1" long excursion full-range cone drivers
- Wide horizontal coverage
- Electronically protected
- Selectable 16 Ω or 64 Ω impedance
- Weatherproof: IP54

3. APPLICATIONS

- Portable and installed AV systems
- Background music systems in stores, restaurants and clubs
- Conference rooms
- Space-sensitive fill for broadcast

4. SAFETY INFORMATION



Warning: Failure to follow these safety instructions could result in injury or damage to the device or other property.

IMPORTANT SAFETY INSTRUCTIONS

- Read these instructions.
 - Keep these instructions.
 - Heed all warnings.
 - Follow all instructions and keep all warnings.
 - Only use attachments/accessories specified by the manufacturer.
- 

 - Use only with the cart, stand, tripod, bracket, or table specified by the manufacturer or sold with the apparatus.
 - When a cart is used, use caution when moving the cart/apparatus combination to avoid injury from tipover.
- **Avoiding hearing damage.** Professional loudspeakers are capable of producing extremely high sound levels and should be used carefully. Never stand close to loudspeakers driven at high volume. Set the volume to a safe level. You can adapt to a higher volume of sound that over time may sound normal but can be damaging to your hearing. Hearing loss worsens after exposure to a sound level of 90 dB or over for an extended period of time. If you experience ringing in your ears or muffled speech, stop listening and have your hearing checked. The louder the volume, the less time is required before your hearing could be affected.
 - **Choking hazards.** This device contains small parts, which may present a choking hazard to small children. Keep the device and its accessories away from small children.
 - **Do not make repairs yourself.** Never attempt to disassemble, repair or modify the system yourself. Disassembling the unit may cause damage that is not covered by the warranty. The device contains no user-serviceable parts. Repairs should only be performed by factory trained service personnel.
 - **Sound distortion.** Do not operate speakers for an extended period of time with sound distortion. This is an indication of malfunction, which in turn can generate heat and result in a fire.
 - **Carrying, handling and installing the device.** The device contains sensitive components. Do not drop, disassemble, open, crush, bend, deform, puncture, shred, incinerate or paint the device nor insert foreign objects into it. If your device has been dropped or damaged, unplug the power cable immediately.
 - **Setup.** Set up your device on a stable, horizontal surface. If combined or mechanically connected with other products, always verify the stability of the resulting system. Install the unit only in a location that can structurally support the weight of the unit and far away from interference with the stability of the system. Ensure the wind does not interfere with the system's stability, using extra securities such as chains, weights, ropes or any other certified anchoring systems. Otherwise a unit could fall, causing property damage, personal injury or even death. The system should only be suspended by qualified personnel following safe rigging practices. Securing fixtures to the building structure are vital. To clarify any doubts, seek help from architects, structural engineers or other specialists.

5. UNPACKING

Each K-array speaker is built to the highest standard and thoroughly inspected before leaving the factory. Upon arrival, carefully inspect the shipping carton, then examine and test your new audio element. If you find any damage, immediately notify the shipping company. Only the consignee may institute a claim procedure regarding the system's electronic equipment.

6. PACKAGING



1 x KV52 speaker

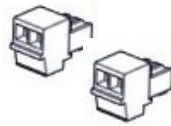

2 x 2-pin phoenix connectors

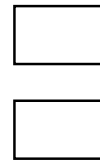

2 x dual lock fastening velcro pieces



2 x wall brackets

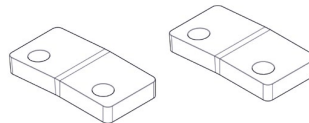

2 x joining plates

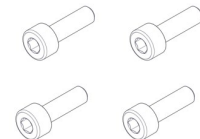

4 x M3 hex screws

7. PHYSICAL OVERVIEW

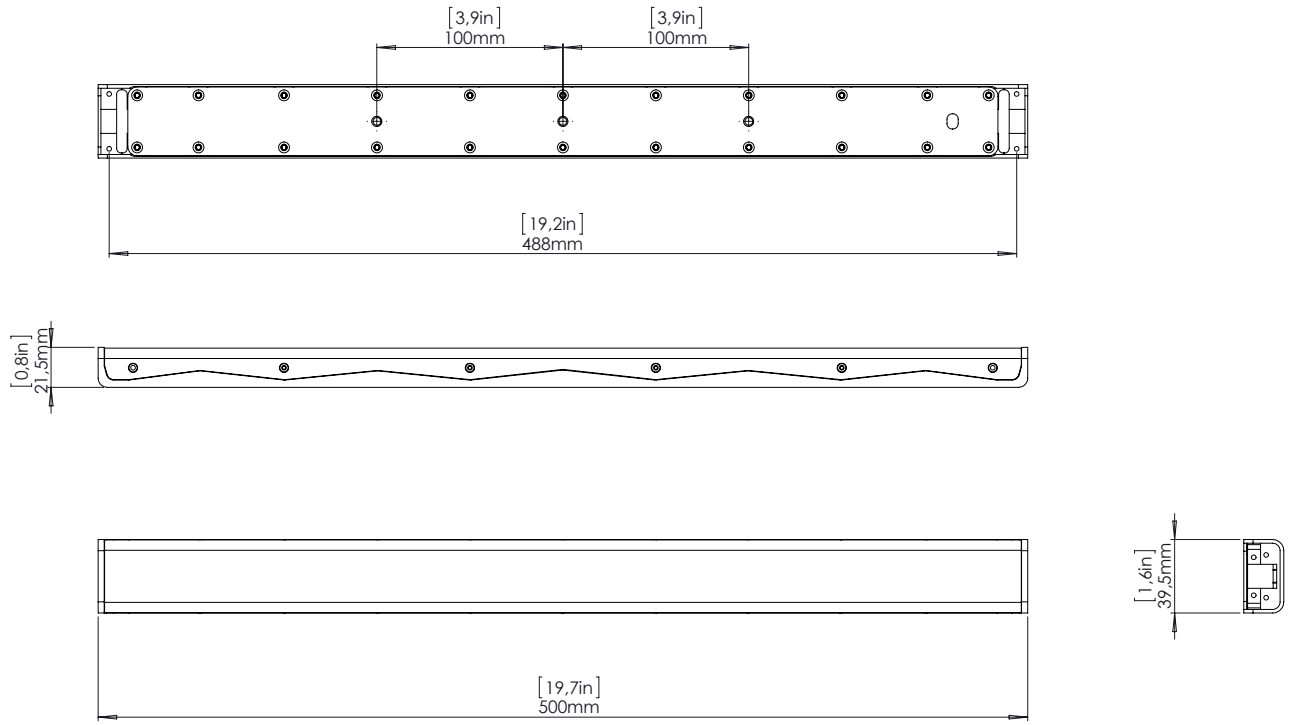

Weight
0.7 kg (1.5 lbs)

8. WIRING

The KV52 features two 2-pin phoenix connectors wired in parallel. The two connectors are interchangeable and can be used to connect the speaker to the amplifier or to connect the speaker to another KV52 driven in parallel by the same amplifier channel.

The KV52 allows the user to select two different values of impedance ($16\Omega - 64\Omega$) with a switch situated on the rear panel. At 64Ω as many as 16 KV52 speakers can be powered off a single KA84 amplifier channel.

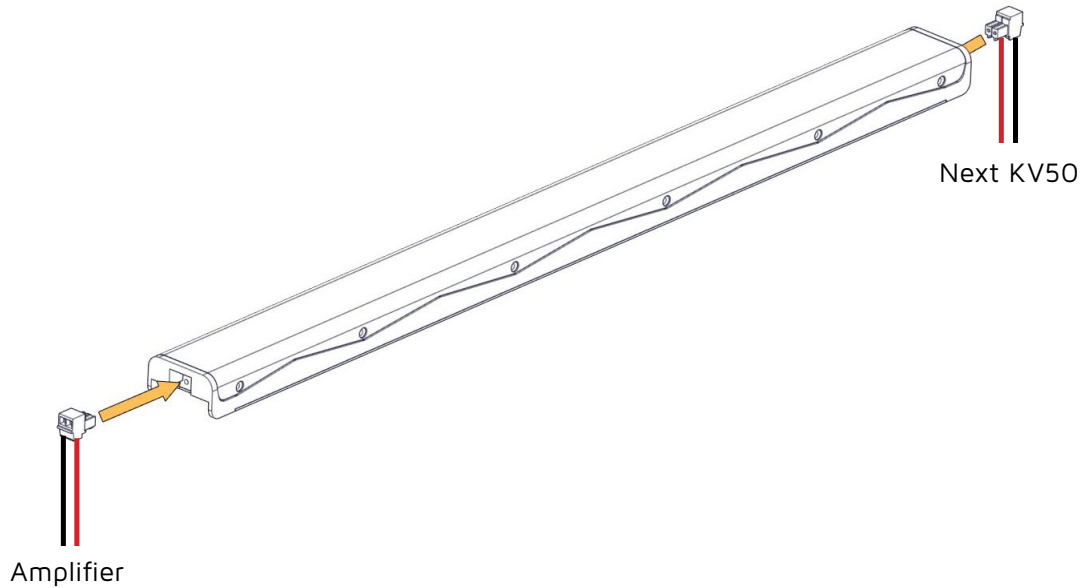

Max number of speakers per channel

	KA14 amp	KA24 amp	KA84 amp
KV50 @ $16\ \Omega$	4	4	NO
KV50 @ $64\ \Omega$	NO	NO	16

9. INSTALLATION

9.1 INCLUDED WALL BRACKETS

The KV52 can be easily installed on the wall using the two included wall brackets. Secure the two brackets on the wall using four M4 screws. Position the KV52 between the two brackets and use the four included M3 hex screws to secure the chassis to the brackets.

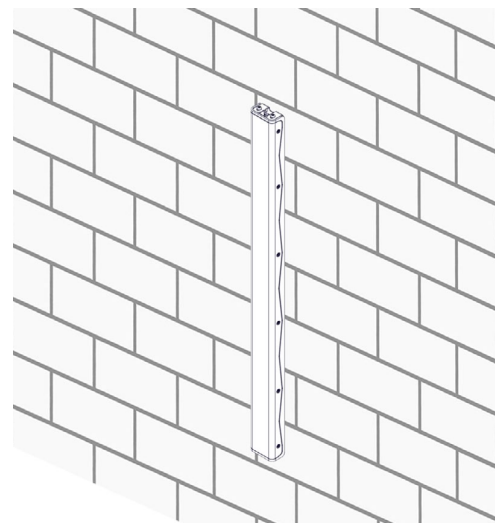
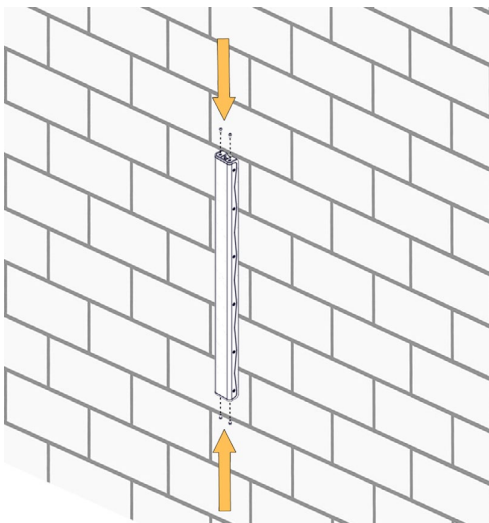
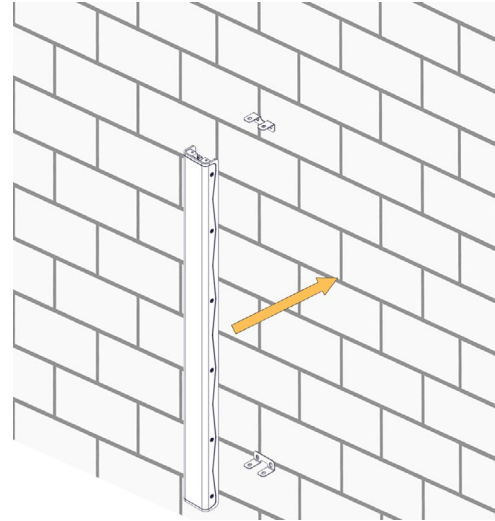
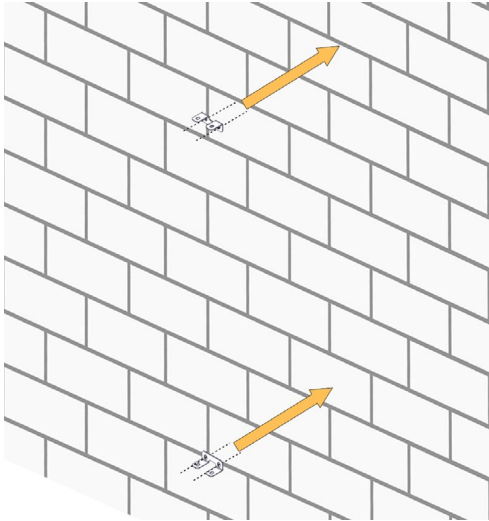

9.2 MOUNTING THE UNIT TO THE WALL

The KV52 can be installed on the wall just using two M4 screws (not included). The grill must be removed to insert the screws (T10 torx screw driver required).

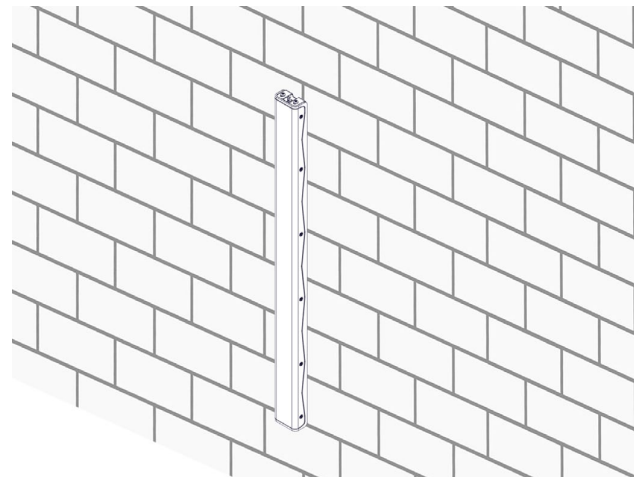
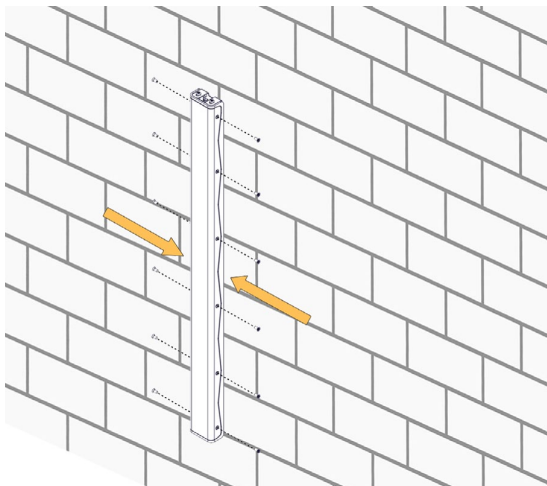
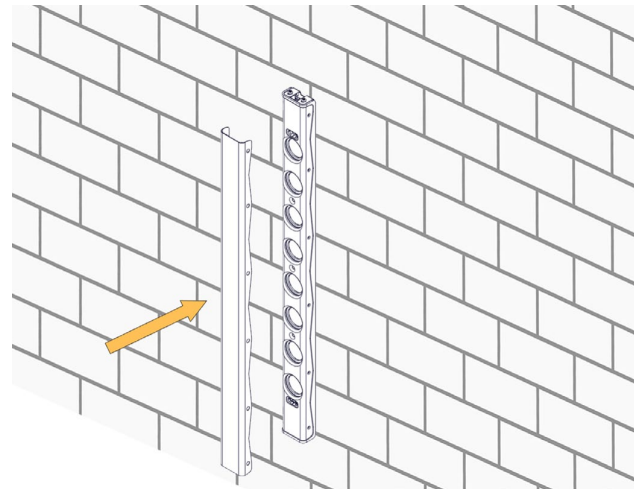
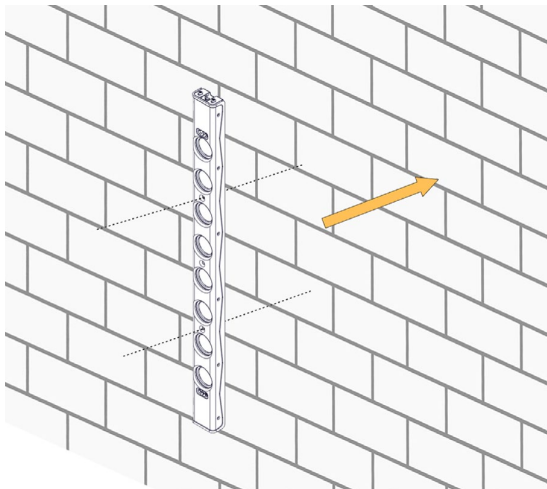
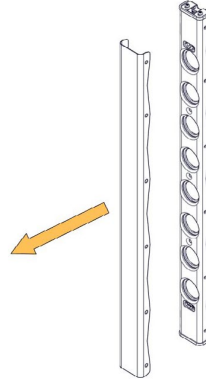
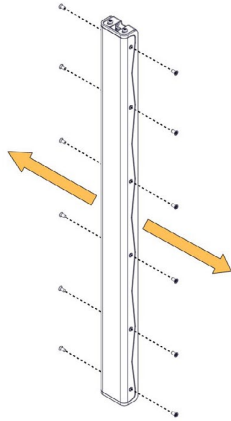

9.3 TILTING THE UNIT

K-WALL2L, K-WALL2 and K-V5WALL1 wall brackets are all compatible with the KV52. K-WALL2L and K-WALL2 allows for tilting the speaker when necessary.

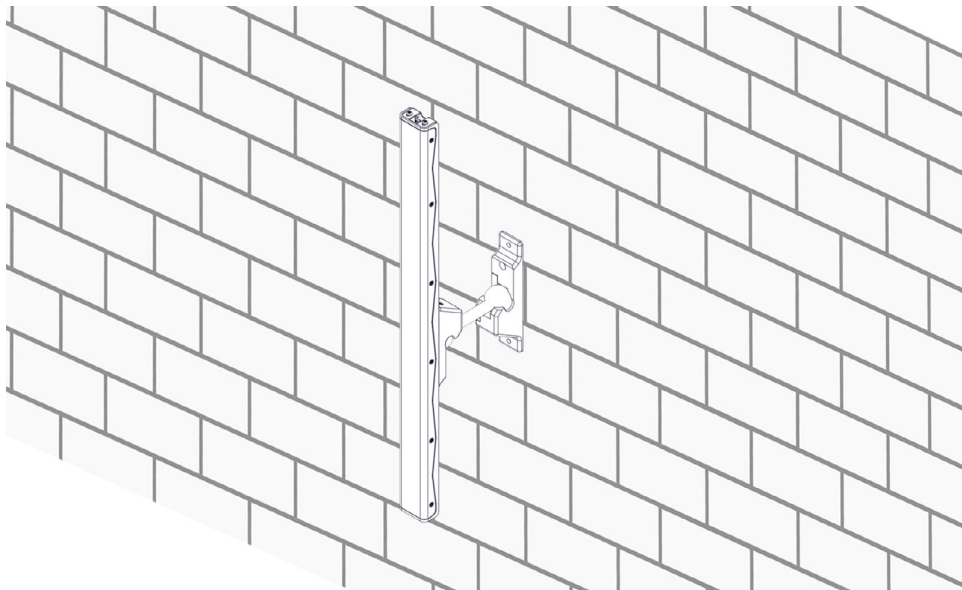
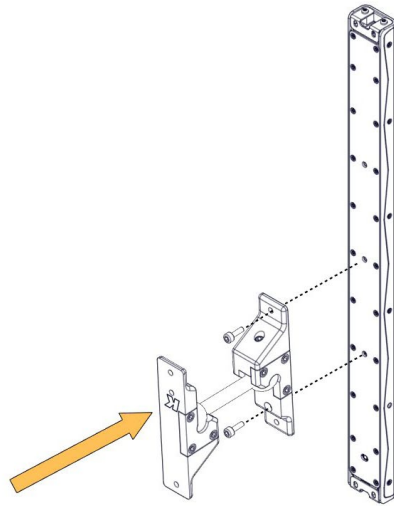

9.4 JOINING TWO UNITS

The two included linking brackets allow the user to join two units together to create a longer array. The bottom unit is tilted 5° downwards to properly cover the audience closest to the array. Use the four included hex screws to join the two speakers.

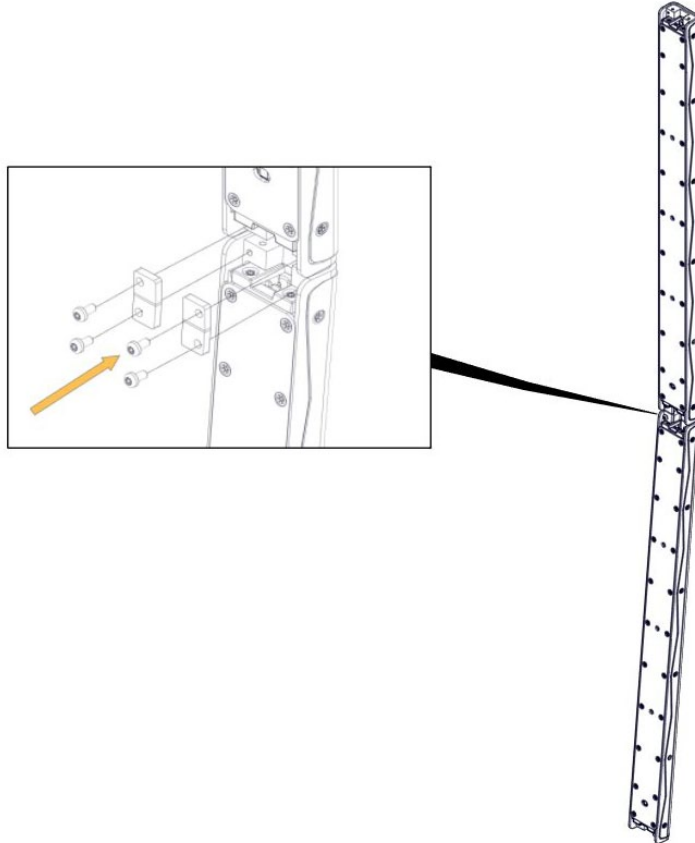

10. SERVICE

To obtain service:

- 1) Contact the official K-array distributor in your country. Your local distributor will direct you to the appropriate service center.
- 2) If you are calling for service, please have the serial number(s) of the unit(s) available for reference. Ask for Customer Service and be prepared to describe the problem clearly and completely.
- 3) If the problem cannot be resolved over the phone, you may be required to send the unit in for service. In this instance, you will be provided with an RA (Return Authorization) number which should be included on all shipping documents and correspondence regarding the repair. Shipping charges are the responsibility of the purchaser.

Any attempt to modify or replace components of the device will invalidate your warranty. Service must be performed by an authorized K-array service center.



Cleaning:

Use only a soft, dry cloth to clean the device. Do not use any solvents, chemicals, or cleaning solutions containing alcohol, ammonia, or abrasives. Do not use any sprays near the product or allow liquids to spill into any openings.

11. TECHNICAL SPECIFICATIONS

	ACOUSTICS		TRANSDUCERS
Power handling	150 W ^(AES)	Full-range	8 x 1" cone driver with 0.75" voice coil
Max power	300 W ⁽¹⁾		POWER AUDIO INPUT
Frequency range	200 Hz – 20 kHz +/- 3dB ⁽²⁾	Connectors	2 x 2-pin phoenix
Impedance	16 Ω / 64 Ω selectable		RECOMMENDED AMPLIFIERS
SPL 1W/1mt	86 dB ⁽³⁾	Type	KA14, KA24, KA84
Maximum SPL	108 dB (cont.) – 114 dB (peak) ⁽⁴⁾		CERTIFICATION
	COVERAGE	IP	54
Horizontal	110°		PHYSICAL
Vertical	10°	Dimensions	39.5 x 500 x 21.5 mm (1.6" x 19.7" x 0.8")
	CROSSOVER	Weight	0.7 kg (1.5 lbs)
Type	External Crossover required		
Frequency	150 Hz, 24 dB/oct suggested minimum		

Notes for data

1. Maximum RMS applicable power for a musical signal. The reference signal is the one proposed by EIAJ standard
2. With dedicated preset
3. Measured @ 4m then scaled @ 1m
4. Measured with musical signal

New materials and designs are introduced into existing products without prior notice. Present systems may differ in some respects from those presented in this catalogue.

12. CERTIFICATION



DECLARATION OF CONFORMITY

Manufacturer/Importer: K-array s.u.r.l.

Brand: K-ARRAY
Address: via Paolina Romagnoli 17 50038 Scarperia e S. Piero Firenze ITALY

Date of Issue: 20 / 02 / 2017

Model Code: KV52 – KV52W – KV52X – KV52XB – KV52XG – KV52XP

Declaration: Complies with safety essential requirements of Council Directive 2004/108/EC on the approximation of the Laws of the Member States relating to electromagnetic compatibility.
 2006/95/EC on the harmonisation of the laws of member state relating equipment designed for the use within certain voltage limits
 This declaration applies to all specimens manufactured in accordance with the attached manufacturing drawings which form part of this declaration. Assessment of compliance of the product with the requirements relating to electromagnetic compatibility and low voltage directive was based on the following standards:

EMC: EN 55103-1:2009
 EN 55103-2:2009
 EN 61000-3-2:2006+A1+A2
 EN 61000-3-3:2008

Safety: EN 60065:2002+A1+A11+A2+A12

RoHS II: Directive 2011/65/UE (08 june 2011)

Marking:



Applying Year: 2017

Applied by: K-array s.u.r.l.
 Via Paolina Romagnoli 17
 50038 Scarperia e S. Piero
 Firenze Italy
 Tel. +39 055 8487222
 Fax +39 055 8487238

Signed by: Franco Spataro
 Technical Manager

K-array s.r.l. a socio unico società soggetta alla attività di direzione e coordinamento di HP Sound Equipment spa
 P. IVA / VAT / CF 06206990480 - R.E.A. 609589 Cap. soc. i.v. € 100.000,00
 Sede legale: via Paolina Romagnoli 17 50038 Scarperia e San Piero - Firenze - ITALY tel +39 055 8487222 fax +39 055 8487238

k-array@pec.it www.k-array.com