

SHURE®

LEGENDARY
PERFORMANCE™

AUDIO SYSTEMS GUIDE

MEETINGS AND CONFERENCES

By Crispin Tapia and Chris Lyons



A Shure Educational Publication



AUDIO SYSTEMS GUIDE

MEETINGS AND CONFERENCES

Table of Contents

CHAPTER 1 Introduction	4	CHAPTER 5 Processing: From Signal to Sound	24
• Importance of Sound Quality	5	• The Mixer.....	24
CHAPTER 2 Sound System Basics	6	• Dynamics Processing.....	27
• Sound System Elements	6	CHAPTER 6 Audio Networking & Control	30
• Ancillary Devices.....	6	CHAPTER 7 The Room's The Thing	31
• Terminology: Key Audio Concepts.....	7	• Room Types & Miking Techniques.....	31
• Connectivity and Networking	8	• Miking The Audience.....	34
• Room Acoustics and Intelligibility.....	9	CHAPTER 8 Multi-Participant Sound Systems	35
• Feedback Fixes.....	10	• A Sound System Designed for Multiple Participants ...	35
CHAPTER 3 The Humble Microphone	11	• Discussion Systems vs. Conference Systems.....	37
• Microphone Types	13	CHAPTER 9 Conclusion and Appendices	38
• Microphone Placement.....	14	• Outside Resources.....	38
• Microphone Connectors.....	16	• Shure Resources	39
• Microphone Techniques	17	• Product Selection Guides.....	40
CHAPTER 4 Wireless Microphones	19	• About the Authors.....	42
• Frequency Compatibility and Coordination	19		
• System Layout.....	20		
• Advanced Wireless Concepts.....	21		
• Wireless Frequencies & the FCC.....	23		



Meetings and Conferences

Audio Systems Guide for MEETINGS AND CONFERENCES

CHAPTER ONE

INTRODUCTION

Welcome to Shure's Guide to Meetings & Conferences.

Traditionally, setting up and operating audio and video systems in an organizational environment was handled by a dedicated A/V department, but at many corporations these responsibilities have now migrated to become part of Information Technology (IT). Thus, along with managing computers and associated software and hardware, many IT managers are now charged with delivering audio across a wide range of their organization's activities. But many IT professionals lack the knowledge to confidently handle the audio aspects of corporate communications.

The problem is that sound is inherently analog. The human voice and ear produce and detect tiny variations in air pressure – not 1's and 0's. Whether it's a small meeting room or a large theater, a public city council or a secure boardroom, a teleconference or a lecture, all sound systems begin and end in the analog domain, and are subject to fundamental rules of physics. And so, today's sound systems are a blend of fundamental analog tools like microphones and loudspeakers with digital signal processing and file-based data transfer and storage. Making a unique blend of technologies work together seamlessly takes a unique blend of knowledge.

Our goal is to enable today's audio-video technicians to translate their professional skills into the world of live sound systems for meetings and conferences. With a firm grasp of

some basic principles, knowledge of the options available – and perhaps a handy reference guide – you can navigate successfully through nearly any situation. A basic understanding of how to capture and deliver the human voice in these environments provides the foundation for success.

This book is therefore aimed at, and dedicated to, the professionals and technicians – from whatever background – tasked with producing flawless audio for meetings and conferences.

The purpose of this document is to give you the experience and knowledge of how to ensure good sound quality in typical business situations, to bridge the gap between your own technical background and the world of professional audio. It will help you to adapt to both legacy equipment and the latest designs. This book is designed to be practical and informal – a reference to guide you through new territory and make smart decisions when faced with unexpected situations. It is all based on science, but we promise to keep it free of math! Rather, we hope to provide easy-to-understand explanations, useful rules of thumb, and informative sidebar notes.

The point is, we have been there and done that for over 90 years, and we like to think that we know how to successfully explain the basics to willing learners – like you.

We hope you find this useful, thanks for reading!



Introduction

Audio Systems Guide for MEETINGS AND CONFERENCES

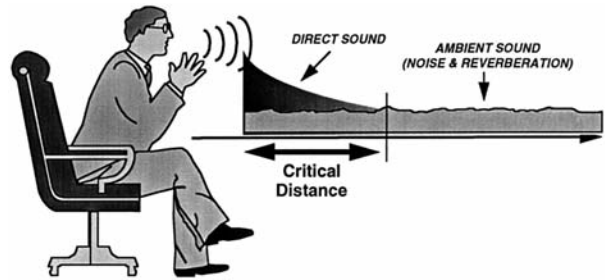

Speech to Noise Ratio

Importance of Sound Quality

Your goal should be to provide exceptional sound quality. Over the past 90 years, Shure has learned a lot about creating good sound. We want to help you do the same.

It's important to realize that "sound quality" is not an absolute term. Rather, it depends on context. What comprises good sound will be different for music as opposed to speech.

Music is about fidelity. Achieving great sound quality in music requires the accurate reproduction of the entire frequency range of the instruments. The harmonious combination of fundamental and overtone frequencies can produce transcendent beauty, further heightened through reverberation within the room.

Speech, on the other hand, is about intelligibility – which is very different. The goal of intelligibility is the easy understanding of the words being spoken. While it seems like that should be easy, the fact is that interference from unwanted sounds can have a profound effect on our ability to accurately perceive speech.

Speech intelligibility is of primary importance in many types of presentation spaces, but perhaps none more so than the corporate environment. You want the CEO's speech to sound great; you want education sessions to be fully

understood. To achieve that, anything that interferes with the clear hearing of the words needs to be minimized or eliminated.

The key is to understand that music and speech systems are fundamentally different in their goals. Audiophile reproduction of music, especially the extreme high and low frequencies, can certainly add to the listener's perception of sound quality, but may also serve to call attention to acoustical flaws that are all too common in meeting rooms and similar spaces. And as anyone who has tried to hold a conversation in an old, high-ceilinged church can attest, reverberation within a room – the time-delayed reflections that bring richness and majesty to music – is one of the biggest enemies of intelligibility.

So this book will focus on intelligibility much more than fidelity.

This differentiation alone should serve as a bit of a wake-up call. Your intuition may tell you that all you need for "good sound" is accurate pickup and reproduction, but the truth is, success in audio is defined by the situation and context.

The enemies of great sound are many. Our goal is to give you the tools and knowledge to achieve it with a minimum of theory and math, and a focus on practical techniques. Can we transmit all that in one easy-to-understand, not-so-thick book? Within the context of the meetings and discussion groups that dominate corporate audio, we know we can.

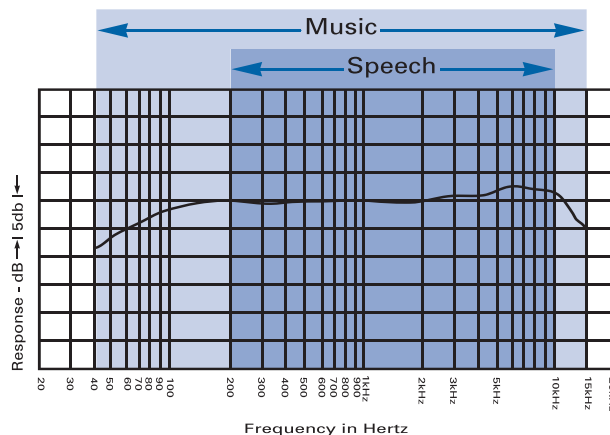

Typical frequency range of speech vs. music

Outside Resources

Think of this book as your Audio Help Desk – sort of a FAQ that addresses the vast majority of challenges you will encounter. For anything beyond that, you will need additional resources.

Online searches are the default resource that most people use. We urge you to search specifically within the field of pro audio, especially with the manufacturers of the equipment you are using, and the integrators who install them professionally.

Shure offers a vast array of customer resources to assist you in getting the most out of your audio equipment. We urge you to check out the resource listings in the back of this book to learn more.

Audio Systems Guide for MEETINGS AND CONFERENCES

CHAPTER TWO

SOUND SYSTEM BASICS

A sound system is an arrangement of components intended to capture and amplify sound within a room, transmit it to a remote location (audio or video conference, online stream), or record it for later consumption. It can be as simple as two tin cans connected by a taut string, or might involve hundreds of sound sources being mixed and delivered to tens of thousands of listeners.

Sound reinforcement is defined as a system for making sound louder and delivering it to an audience. In terms of meetings and conferences, our primary interest is in live sound reproduction of the human voice, with the specific goal of helping each participant hear the intended message clearly. While we will touch on other system types, the focus of this book is on meetings and conferences.

In small meeting rooms, sound reinforcement is usually unnecessary because participants are close enough to hear each other naturally. Sound reinforcement becomes important when people at one end of the room can't comfortably hear those at the other end. This might be due to the size of the room, the seating layout, or acoustic conditions.

We are going to skip the traditional "definition of sound" discussion, because it's pretty intuitive. For purposes of this book, it's useful to know that sound is a wave phenomenon, with the pitch, or frequency, of the sound being measured in cycles per second, or Hertz. The amplitude of the sound wave defines how loud it is, and is usually measured in decibels of sound pressure level (dB SPL).

Sound System Elements

Most sound systems involve four types of devices working together: Input, Processing, Amplification, and Output. Let's define those.

Input device – a way of delivering audio into a sound system. For acoustic sources (like the voice), the input is typically a microphone. A microphone is a transducer, which means that it converts the acoustic energy from the sound source into an electrical signal. Audio from electronic sources is typically delivered directly via a cable.

Processing device – a means of adjusting inputs. These can be divided into two groups: mixers and signal processors. A mixer combines the signals from multiple sources, accommodating between two and several hundred inputs. A signal processor is a device used to help adjust the sound quality. A processor might provide multiple functions



like equalization (tone shaping), compression, and feedback suppression, among others. In many cases, the mixer and signal processors can be found together in one device.

Amplification device – used to increase the overall volume of the sound system's output. The power amplifier boosts the electrical audio signal to drive the output devices (e.g., loudspeakers or headphones) to the desired level. Complexity can range from a single channel to many, depending on the design of the system.

Output device – a means of delivering the audio to our ears, such as a loudspeaker, headphones, or in-ear monitors. Like the microphone, the loudspeaker is a transducer, converting the electrical signal from the amplifier back into acoustic energy.

Ancillary Devices

In addition to sound reinforcement, a sound system might be asked to accomplish other goals. These are easily recognized by the addition of alternative output devices dedicated to specific needs.

Recording: An audio recorder may be utilized to capture the audio program for later use. Typically, one might simply record the mixed output of the sound system, enabling review and archiving. Some systems are far more complex, capturing each input separately for later editing and remixing (known as "post," which is short for post-production). Video may also be involved.

Teleconferencing: A two-way transmission system that sends the source audio to distant locations. This may be implemented via telephone or computer through collaborative software. Teleconferencing is interactive in real time (full duplex), allowing all listeners to participate in the meeting. Many companies have dedicated meeting rooms for this purpose.

Audio Chain

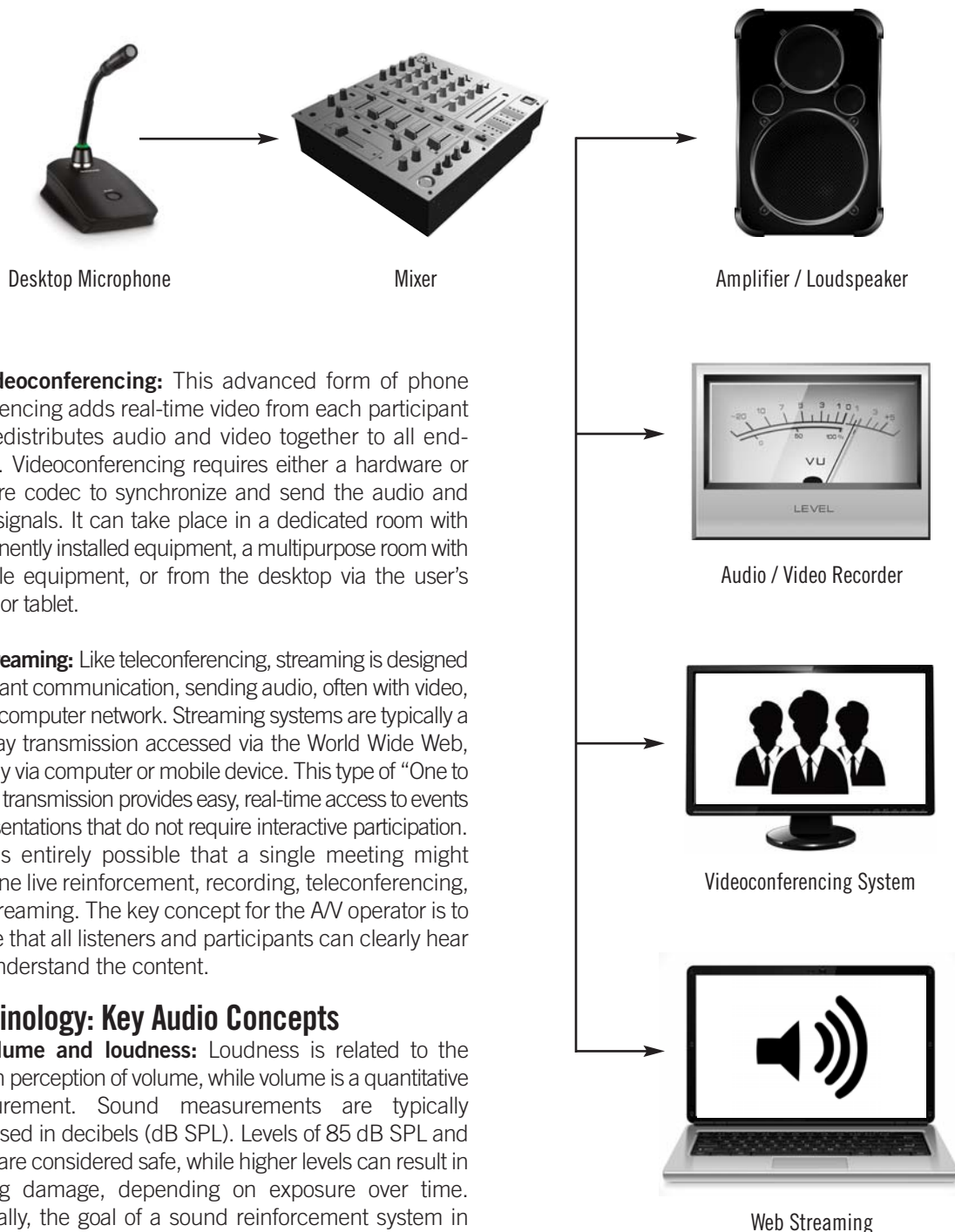

Videoconferencing: This advanced form of phone conferencing adds real-time video from each participant and redistributes audio and video together to all endpoints. Videoconferencing requires either a hardware or software codec to synchronize and send the audio and video signals. It can take place in a dedicated room with permanently installed equipment, a multipurpose room with portable equipment, or from the desktop via the user's laptop or tablet.

Streaming: Like teleconferencing, streaming is designed for distant communication, sending audio, often with video, over a computer network. Streaming systems are typically a one-way transmission accessed via the World Wide Web, typically via computer or mobile device. This type of "One to Many" transmission provides easy, real-time access to events or presentations that do not require interactive participation.

It is entirely possible that a single meeting might combine live reinforcement, recording, teleconferencing, and streaming. The key concept for the A/V operator is to ensure that all listeners and participants can clearly hear and understand the content.

Terminology: Key Audio Concepts

Volume and loudness: Loudness is related to the human perception of volume, while volume is a quantitative measurement. Sound measurements are typically expressed in decibels (dB SPL). Levels of 85 dB SPL and below are considered safe, while higher levels can result in hearing damage, depending on exposure over time. Generally, the goal of a sound reinforcement system in a meeting environment is simply to bring low-level speech up to a normal, clear conversational level at the listener's position (about 70 dB SPL).

MEETINGS AND CONFERENCES

Inverse-square law: Sound waves are governed by the inverse-square law, meaning that doubling the distance traveled reduces the level at that distance by a factor of four (two, squared). Thus, distance from source to microphone, and from loudspeaker to listener, are critical factors in determining and controlling the effective loudness of a system, as well as its potential for feedback and the pickup of unwanted ambient noise.

Gain: In audio terms, gain refers to increasing the power or amplitude of the audio from the input to the output of the audio chain, usually measured in decibels (dB). When the input level equals the output level, they are said to be at unity gain. That is, there is 0 dB difference between the input and output.

Feedback: An acoustic phenomenon whereby a sound source is amplified and recycled back into the audio chain by the loudspeakers. When this sound is picked up (again) by the microphone, it is re-amplified and thus grows louder, generally at one or more of the system's resonant frequencies. The result is an out-of-control howling or squealing that requires that this cycle of sound be broken – usually by turning the system down – in order to stop it.

Gain Before Feedback: How loud you can go before causing feedback. Being able to achieve sufficient gain without causing feedback is one of the most basic goals of any sound reinforcement system. We hope to teach you how to achieve that.

Direct vs. indirect sound: The shortest distance between the sound source and its destination (line of sight) defines direct sound. Direct sound maximizes signal strength while minimizing delay. Indirect sound travels a longer distance and thus, is both delayed and (ideally) lower in level relative to direct sound by the time it reaches its destination.

There are several different types of indirect sound, including echo and reverberation. Taken together with noise (HVAC, lighting hum, etc.) and the acoustics of the room, the indirect sound achieves a relatively constant level. Rooms with a lot of hard, reflective surfaces will tend to have a “lively” sound, while those with a lot of absorbent materials will have significantly less ambience, and a higher ratio of direct to indirect sound, which is desirable.

For the purposes of speech intelligibility, this is important because too much indirect sound can create a muddy, indistinct, or hollow sound that actually interferes with the clear understanding of language.

Noise: Anything that interferes with the desired sound source – that is, any unwanted sound – is considered “noise.” Obvious noise sources include fluorescent light fixtures, heating and air conditioning systems, and sounds from outside the room. Sounds from meeting participants (typing, shuffling papers, buzzing smart phones, footsteps, etc.) are another source of unwanted sound. While modest levels of background noise are acceptable (and inevitable) depending on the intended use of the space, excessive noise will degrade speech intelligibility.

Latency and Delay: Latency describes the time delay between the input and output of a system, usually measured in milliseconds. In pure analog systems, there is essentially no latency, while digital systems all have an inherent delay. While latency is rarely a big issue in meetings and conferences, it can become a factor in system design.

In analog systems, audio travels in the electrical domain and is transmitted without measurable delay. Digital audio is different. The computation process involved in transforming the (analog) electrical signal into digital data takes time. Similarly, digital signal processing adds a bit more latency, as does the final transformation of digital audio back into analog for amplification.

Depending on the speed and efficiency of the converter being used, system latency can potentially approach 30 milliseconds, creating enough delay to be distracting to listeners.

Connectivity and Networking

Combining multiple systems together is an age-old problem in audio, where systems and equipment have evolved rapidly, yet must be compatible with legacy equipment. This is especially important when combining analog and digital components.

Digital vs. Analog: Analog audio has certain advantages in sound reinforcement (live sound), as it works in “real time,” with no perceptible delay between sound source and system output.

However, the advantages of digital audio are many. Being file-based makes reproduction trivial, with no generation loss. Thus, the content is extremely portable, with a vast array of digital signal processors available with relative immunity from interference from outside signals during transmission. In addition, once the audio is safely transformed to the digital domain, it can be routed across an IT network just like any other file-based content, with relative immunity to interference from outside signals during transmission.

Audio Systems Guide for MEETINGS AND CONFERENCES

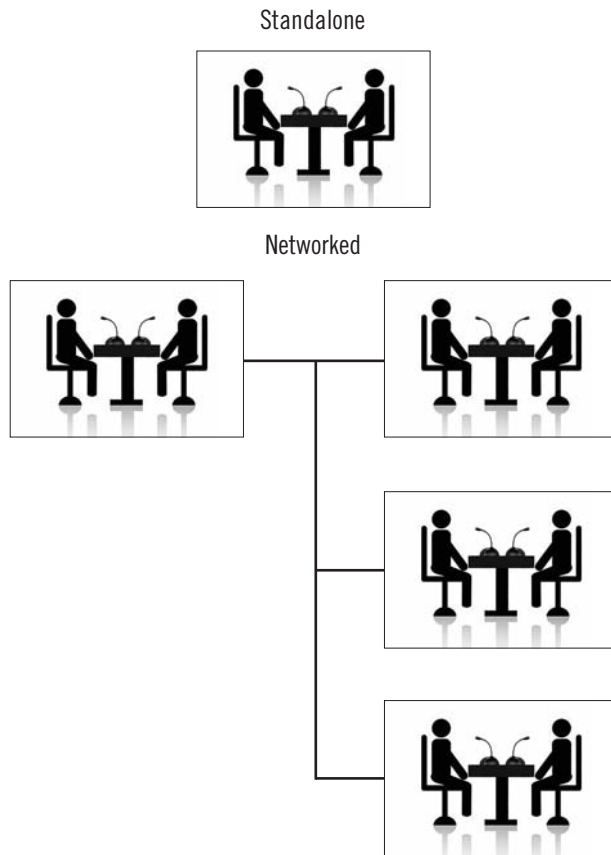

Standalone VS. Networked Systems

Standalone vs. Networked Systems: The primary goal of a sound reinforcement system is to provide high quality audio within a room. All that is required is the capture, manipulation, and delivery of sound. A dedicated, standalone system is often the best way to accomplish this. Adding the ability to interface with outside spaces is what defines a networked audio system. It is especially important for IT professionals to note that networked audio systems can be either analog or digital. Obviously, to distribute audio over a computer network requires the audio content to be digital.

Today, many sound systems are designed to interface with computer networks, either for remote monitoring and control, or for distribution of audio to multiple rooms. This is done by converting all audio to the digital domain and sending to its destination via a cable with an RJ45 plug – the same type used for Ethernet connections. (Always check your system for specific cable requirement.) Such systems are highly desirable, since most organizations are already wired with Ethernet connectivity.

Compatibility: Consumer vs. Pro Audio: As the term suggests, pro audio equipment is typically found on stages and in studios, and in meeting and conference facilities where a high degree of reliability and flexibility is required. Consumer audio gear is designed for home use. There are historical reasons for this division, primarily relating to cable length, fidelity, reliability, and signal integrity.

In general, audio equipment is differentiated by output type, which can be either Mic Level (typically around 2 millivolts) or Line Level (roughly one volt). A Line Level signal will overload a Mic Level input, while a Mic Level signal will be barely audible when plugged into a Line Level device. It's important to be aware of these differences when adding new equipment to a system. Another useful compatibility specification is impedance. Most pro audio gear is low impedance (called lo-Z), while consumer hardware operates at high impedance (hi-Z).

Getting different equipment to work well together typically happens at the mixer, which can often accommodate input sources with a variety of connector types and signal levels, adjusting them so that they all work together.

Pro tip: Pro and consumer equipment tends to use different connectors, which is a good indicator when evaluating compatibility. Generally speaking, when the input and output connectors on two pieces of gear don't match, proceed with caution.

Room Acoustics and Intelligibility

Room ambience and acoustics have a profound effect on intelligibility. This sound can reflect around the room, arriving at the ear as a series of repetitions, each slightly delayed after the direct sound. This condition can alter the combined audio signal so that it is more difficult for the human brain to understand, thus reducing intelligibility.

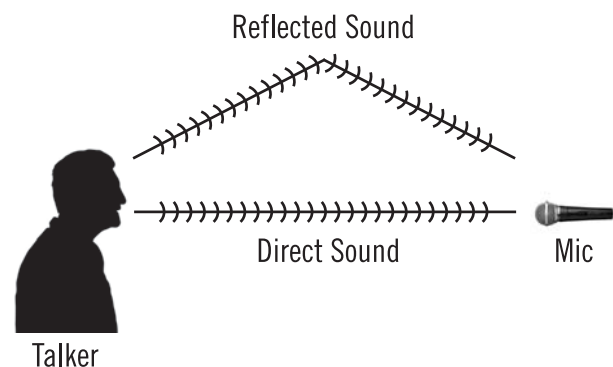

Direct VS. Reflected Sound

Audio Systems Guide for MEETINGS AND CONFERENCES

Each room has an acoustic signature. The size, shape, furnishings, and physical materials combine to define how sound behaves within the space. The more reflective surfaces in the room, the more “lively,” or reverberant, it sounds. The larger the room is, the longer the acoustic pathways are, creating more delay and thus, more opportunities for intelligibility issues. Rooms with a lot of absorptive materials, such as carpeted floors and upholstered furniture, help minimize reflected sound, which aids in preserving intelligibility.

Since it is generally impractical to make architectural changes to a meeting or conference room, the deployment of the sound system – especially the positioning of the microphones and loudspeakers – is a critical component in maximizing intelligibility while avoiding feedback.

The Truth About Feedback

While routinely blamed on the microphone, the fact is that microphones are passive devices that cannot reach out and “grab” sound. Rather, acoustic feedback is system-based. It is caused by a combination of factors, including room acoustics and amplification levels, plus positioning, directionality, and transmission paths of microphones and loudspeakers, all of which can contribute to poor gain-before-feedback.

Bad microphone technique often prevents the sound system from performing well. Educating presenters on mic technique is just as important as great room acoustics. Understanding how room acoustics impacts the system's ability to perform is crucial to minimizing the occurrence of feedback.

Creating good sound without feedback is a balancing act between the room's Potential Acoustic Gain (how loud it can get without feedback) and Needed Acoustic Gain (the amount of gain required so everyone can hear). While the mathematics of PAG/NAG are important in room design, familiarity with best practices in the placement and use of sound system elements should be sufficient for the effective use of existing systems. For more details, see the sidebar on Feedback Fixes.

The more reverberant the room, the more likely it is for feedback to occur. Highly reverberant spaces generally have reduced intelligibility, which in turn makes users want to turn up the volume in an effort to hear more clearly. Like feedback itself, it's a vicious cycle. Fortunately, a little knowledge is all it takes to keep it under control.

Feedback Fixes

Understanding the causes and potential cures for feedback is a critical skill in sound reinforcement. Fortunately, the phenomenon and its cures are well known.

When feedback occurs, remain calm. Turn down the sound system's master gain (volume) to stop the squealing. Once you've got the system back under control, it's time to look for causes and fix them.

While instinct suggests that something is too loud, it might also be that something is pointed in the wrong direction. Here's a full list of all available fixes:

- Move microphones closer to sources. Have the presenters sit closer to their mics. Let the microphones do the work.
- If possible, move loudspeakers closer to the audience.
- Reduce the number of open (live) microphones. Every open microphone is another audio path for potential feedback and unwanted noise.
- Use directional microphones and loudspeakers. Position mics so that the desired sound source is on-axis, using the pickup pattern's null point to exclude unwanted sounds.
- Use a feedback reducer – These can automatically turn down the offending feedback frequency with minimal effect on the rest of the mix.
- Add acoustic room treatment – Sound-absorbing wall and window treatments can significantly reduce room reverberation.

CHAPTER THREE

THE HUMBLE MICROPHONE

As the primary sound source and first link in the audio chain, the microphone is critical to the overall quality of a sound system. Manufacturers design mic models that are optimized for specific tasks, so selecting the right one starts with a knowledge of the specific application involved, considering both the sound source and its destination.

In meeting and conference systems, the primary microphone usage is for human voice, which allows us to bypass a lengthy discussion of mics for musical instruments. Vocal mics come in a wide array of form factors, and are differentiated by five primary characteristics.

Operating Principle

This refers to the type of “engine” driving the microphone, turning the sound waves into a small electrical voltage. In meetings and conferences, almost all mics are either dynamic or condenser type. Dynamic microphones are rugged and reliable, relatively economical and do not require a power source. Condensers are more complex in design and typically more sensitive to quiet sounds, requiring a power source to operate. They have the advantage of being easier to design with flat frequency response, and can be made very small without significant loss of performance.

Frequency Response

This is an inherently deceptive microphone metric, because a “good” response graph is nearly impossible to identify. While equal response at all frequencies – called a flat or uncolored response – would seem to be an obvious goal, that sort of microphone is better suited to wide-range music instruments like pianos.

Vocal microphones are usually designed with a shaped, or tailored, response. The idea behind a shaped response is to enhance the sound by smoothly emphasizing the desired frequencies (in our case, the upper midrange for vocals) while minimizing frequencies outside the vocal range.

A common question is whether men and women require different microphone models. In general, the answer for the spoken word is no. While the sexes do differ slightly in their average frequency ranges, both are well within the frequency range of a typical vocal microphone.

Directionality

This is how the microphone responds to sound from different directions, also called its polar response, and is extremely important in sound reinforcement systems. The two main types are omnidirectional (“omni”), which responds equally to sound from anywhere; and unidirectional (“uni”), which is most sensitive to sound from only one direction. For sound systems (with mics and loudspeakers in the same room), unidirectional microphones have definite advantages – basically, because they can be aimed.

Unidirectional microphones have maximum pick-up in one specific direction (called “on axis”), with increasingly less sensitivity as the angle of incidence gets further off-axis. Significantly, there is also an angle of minimum sensitivity, called the null point.

There are several varieties of unidirectional microphones, with progressively narrower coverage angles and different null points. The most common form of unidirectional mic is cardioid, which combines a wide effective coverage area (about 130 degrees) for maximum on-axis pickup, with a deep null point at 180 degrees, for rejecting sound directly behind the mic. Other types of unidirectional polar patterns offer progressively narrower coverage angles and different directionality for their null points. Bi-directional microphones also exist, but are rarely used in meeting scenarios.

By pointing it directly at the desired sound source, a unidirectional microphone picks up more of the intended sound and less unwanted ambient sound. Off-axis sound sources are naturally quieter than the presenter, while sources aimed at the mic’s null point will be virtually inaudible through the sound system. Well-planned microphone positioning can minimize the pickup of unwanted sound sources (other presenters, rustling papers, loudspeakers, etc.), thus enhancing sound

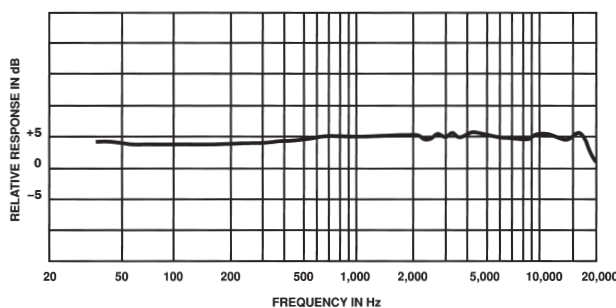

Flat frequency response

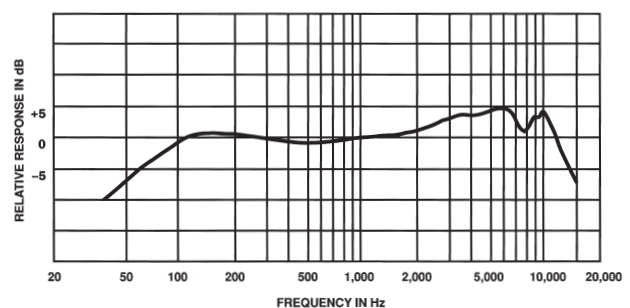

Shaped frequency response

Audio Systems Guide for MEETINGS AND CONFERENCES

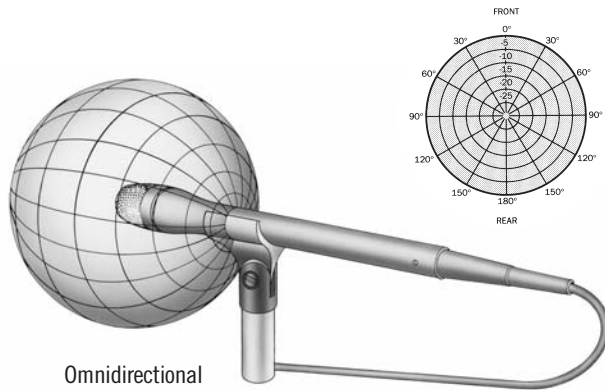

Omnidirectional

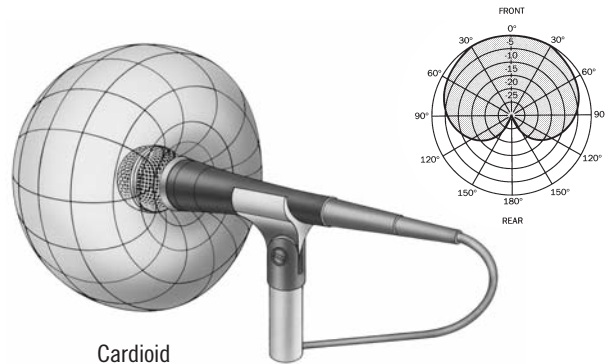

Cardioid

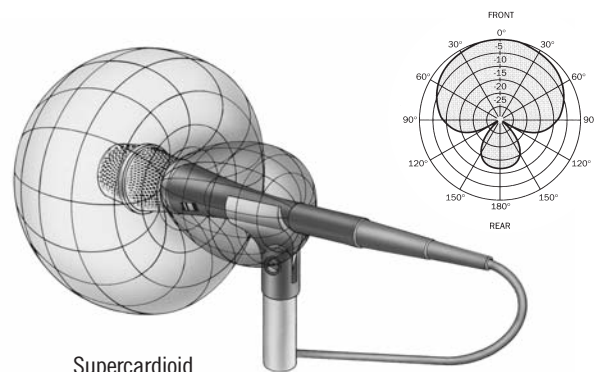

Supercardioid

quality while reducing the possibility of feedback. Insuring the null point of a unidirectional microphone is directed at loudspeakers can also improve gain before feedback in sound reinforcement.

Because they “hear” sound from all directions equally and thus cannot be aimed, omnidirectional mics are more prone to feedback, and thus are seldom used in meeting facilities with live sound reinforcement systems. Omni microphones are often used when no loudspeakers are active, such as a recording or broadcast studio.

Electrical Output

The output of a microphone is a small electrical signal. For effective operation, the output needs to be matched to the input specifications of the sound system it is being plugged into. To compare between mics, the output level is measured when the mic is confronted with a known reference sound pressure level. This output, measured in millivolts, is called sensitivity.

Microphone outputs fall into two categories, depending on their electrical resistance, called impedance. Low impedance, or low-Z, microphones, are usually rated between 150 and 600 ohms, and are generally found in professional applications. High impedance (high-Z) microphones are typically rated at 10,000 ohms impedance or more, which is common in consumer gear.

Another factor is the microphone’s wiring scheme, which might be balanced or unbalanced. Pro audio gear tends to be balanced, which means that the output signal is carried on two shielded conductors of opposite polarity. This helps reject noise and hum in the cable through common-mode rejection at the mixer input, leaving the original mic signal intact. An unbalanced microphone output uses just one conductor and a shield, making it susceptible to noise and hum picked up by the cable.

How a Balanced Input Works

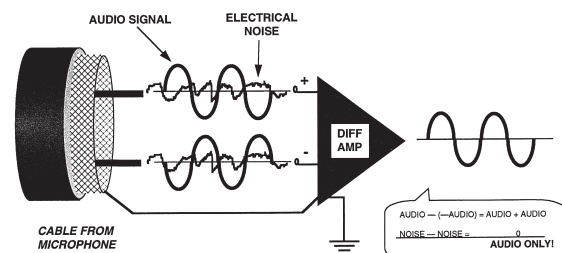

How an Unbalanced Input Works

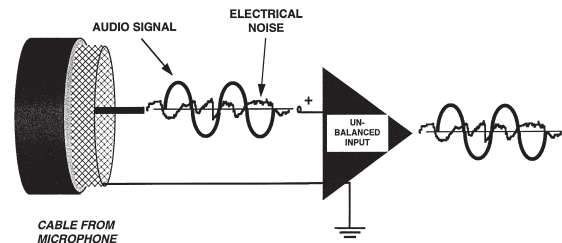

Balanced and Unbalanced Cables and Connectors

Thus, a microphone can be described electrically on three metrics: balanced or unbalanced wiring; low or high impedance; and sensitivity. The two most common configurations – both for microphones and for mixer inputs – are balanced low impedance and unbalanced high impedance. Before adding a microphone to any sound system, determine the type of input the sound system is designed to accommodate.

Since virtually all high quality microphones have balanced, low impedance outputs, this is the recommended configuration for use in most meeting and conference facilities.

Microphone Types

This refers to the microphone's physical design, including size, shape, and mounting method. The primary types are stand-mounted and user-worn, with specialty types like surface-mount and hanging mics also being fairly common. For vocal applications, some design elements are fairly universal, while various models offer additional variations to meet specialized needs. In general, good vocal microphones are designed with internal pop filters and shock mounts to minimize unwanted noise. Size, shape, weight and feel are all important design considerations, while additional features relevant to the intended application might also be included.

Stand-mounted Microphones

The two main types of stand-mounted microphones are handheld and fixed. Handheld microphones are easily removed from their mic stand, while fixed models are anchored to a specific location, such as a podium or tabletop. Stand mounted microphones for conference rooms may be large or small, dynamic or condenser, and are nearly always unidirectional.

Other traits shared by quality stand-mounted vocal microphones are a shock-mount system and pop filter. The pop filter is usually internal and designed to control the sound from plosive sounds (the popping “p”). Shock mounting is also important for preventing sounds such as handling noise and thumps on the mic stand or tabletop from getting into the sound system.

Handheld: Typically distinguished by a prominent, often ball-shaped grille, the handheld vocal mic is ubiquitous – found everywhere from meeting spaces to rock music stages. Designed to excel across a wide range of applications, handheld mics are clipped to a mic stand when not being held by the user.

Whether dynamic or condenser, a high quality stand-



Lavalier Microphone



Podium/Gooseneck Microphone

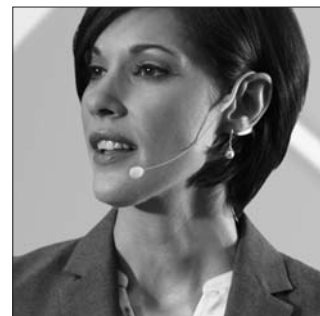

Headworn Microphone



Handheld Microphone

mounted microphone requires advanced internal design elements. To keep handling noise to a minimum, an internal shock-mount system is needed – especially in handheld applications. Because they are often deployed very close to the mouth, microphones should also have a pop filter – usually internal – to control plosive (popping “p”) sounds.

Fixed: Permanent installations like a conference or board room often employ fixed microphone locations, which prevents the mics from being placed incorrectly while meeting both audio and aesthetic requirements. Fixed microphones are typically either a “gooseneck” (mic at the end of a flexible, extended tube) or boundary type, which sits directly on the conference table or lectern surface.

User-worn Microphones

The most common varieties of “worn” microphones are headworn and lavalier. All are designed to be very small and unobtrusive while keeping the user's hands free. Due to their small size, body-worn microphones are usually condenser type. One big advantage of user-worn mics is the ability to maintain a consistent distance between the presenter and the microphone.

Audio Systems Guide for MEETINGS AND CONFERENCES

Lavalier: Also known as lapel mics, these microphones are usually affixed directly to the clothing in various ways. Most often seen on studio news anchors, some lavalier mics can also be worn as a lanyard, or even hidden in the hair.

Headworn: These devices suspend the microphone from a piece of headgear, often hooked over the ears. Originally an outgrowth of the bulky broadcast headphone, today's headworn microphones are designed to be very lightweight and comfortable, often using a low-profile headband that hooks over one or both ears.

Size, appearance, and user comfort are all critical in the selection of user-worn microphones. Some individuals are uncomfortable or may be distracted by headworn or lavalier mics. It's also important to double-check the mic's directional characteristics, as many popular miniature microphones in this category are actually omnidirectional and thus more prone to feedback in high-volume live sound situations.

Specialty Microphones

This category covers other microphones that might be useful in meeting rooms where specific problems need to be addressed. Most notable among these are boundary microphones, also called table mics or surface-mount mics, which are great for covering the sound around a large, flat surface like a conference table or wall.

Boundary microphones are flat in shape, giving them a desirable low visual profile. Boundary mics are most successful when affixed to large, hard surfaces, and have the advantage of minimizing problems with reflected sound that can cause phase issues in conventional mics. This style of microphone is designed for area pickup, as opposed to other styles of miking that put the presenter directly "on mic."

Hanging microphones are most often deployed for area or group miking, and are most often seen above church choirs. They have the advantage of not taking up desk space, but can be difficult to aim accurately. Successful implementation of hanging mics is heavily dependent on room acoustics.

Ceiling microphones are rarely recommended, primarily because they are too far from the sound source to provide the required level of intelligibility. The successful use of ceiling mics requires specialized circumstances and equipment beyond the scope of this book.



Microphone Placement

By properly selecting the right microphone and deploying it optimally, the A/V operator can avoid and even eliminate many typical problems. The best placement depends on a range of factors, but the underlying principles are constant.

For simplicity, we will assume a typical corporate sound system, with individuals as the main sound sources and a basic loudspeaker PA system for reinforcement. The main idea is to maximize intended sound (speech) while minimizing unwanted sounds. This section offers a series of pro tips designed to do just that.

Because audio follows the inverse-square law, you'll get the best results by placing the microphone as close as possible to the intended sound source. This is the single simplest thing you can do to maximize audio intelligibility while minimizing the chance of feedback.

Similarly, it is important to ensure that loudspeakers are not aimed at any microphones. In a typical rectangular room, this is most simply done by making sure no loudspeaker is behind any microphone position. If the talkers are mobile, it's important that they be instructed not to walk in front of the loudspeakers, as this is very likely to cause feedback.

Knowing and utilizing the null angle of a unidirectional microphone to avoid unwanted sound is a great way of avoiding trouble. If a loudspeaker is aimed at the space where a talker is stationed, be sure the microphone is positioned such that any loudspeakers are aimed as far off-axis as possible – preferably at its null point.

Audio Systems Guide for MEETINGS AND CONFERENCES

Here are a few more key factors in determining the best deployment of your sound system's microphones.

Proximity Effect – This refers to an increase in low frequency response of unidirectional microphones at short distances. Thus, when a presenter nears the mic, the sound becomes both louder (due to inverse-square law) and more bass-intensive. When very close to the mic, the proximity effect can be quite pronounced, lending an authoritative tone to the speaker that can be used to great advantage.

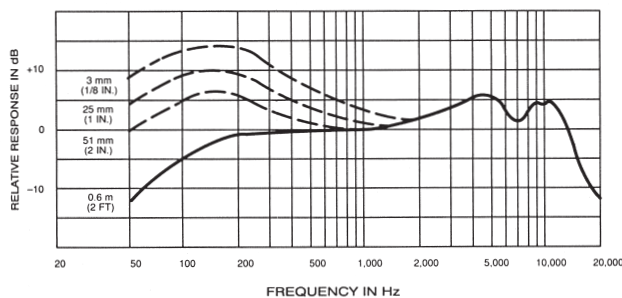

Proximity effect graph

Pro tip: Because extreme close-up speech also makes the vocal air stream audible to the microphone, it's important to have adequate pop filtering in place. If the microphone is unpleasantly loud on plosive consonants (*b, d, p* and *t* sounds), consider adding an external foam windscreen to eliminate the popping.

Interference Effects – An unpleasant interaction between direct and delayed sound. There are three main types of interference effects, all caused by separate, avoidable circumstances:

Reverse polarity causes physical cancellation of sound. In balanced microphones, this can happen when two microphones and their cables are wired with opposite “hot” pins. You can test this by substituting mics and cables already known to be good and listening to the sonic result.

Multiple Microphone Pickup is another interference effect, caused by mixing two microphones at different distances from the same sound source. Due to the delay time in traveling to the more distant mic, peaks and notches are created in the frequency response of the mixed signal, called **comb filtering**, causing a hollow, distant sound. The obvious solution is to avoid picking up the same source with more than one microphone. Since that is not always possible in conference situations, use the **3-to-1 Rule** to ensure that any comb filtering effects are inaudible.

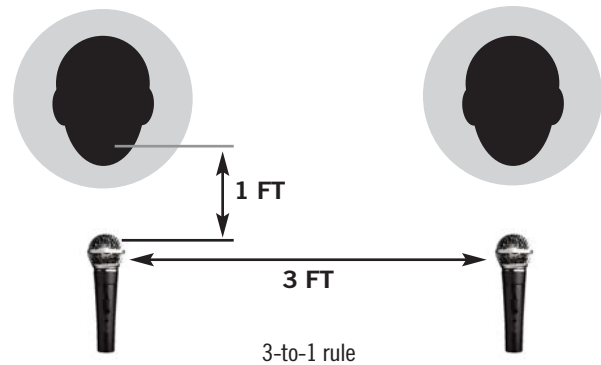

When using multiple microphones, the distance between any two active mics should be at least three times the distance between the microphone and its source.

Pro tip: If a presenter wearing a lavalier microphone steps up to the podium or picks up a handheld mic, make sure only one of those microphones is active! Similarly, if a podium is double-miked with two gooseneck microphones for redundancy, only one should be turned up at a time.

Reflection Pickup is the third form of interference effect. The problem is that sound arriving at a single microphone along multiple paths (and thus at slightly different times) causes comb filtering. The effect becomes audible when the mic is placed too close to a reflective surface, causing the reflected sound to be nearly as loud as the direct sound.

Reflection pickup issues are often solved through mic positioning, reorienting things so that the direct sound is more dominant. Changing the angle of the microphone so that reflections are in the null point of the pickup pattern is the most effective solution. It is also helpful to move the microphone closer to the sound source, or move it away from the reflective surface. Covering the reflective surface with sound-absorptive material can also be helpful.

It should be noted that boundary microphones address this very issue by embracing the reflections. This is done by moving the microphone element very close to the reflective surface (1/4-inch or less), making the delay so short that any comb filtering occurs only at inaudibly high frequencies.

Pro tip: Use Minimal Microphones

Multiple microphones can create other problems. Every open channel adds a small bit of noise to the system, and noise is the enemy of intelligibility. In addition, each open microphone channel adds more ambience to the mix, increasing the potential for feedback.

In general, always use the fewest microphones needed to get the job done. If the system you are using has more mics than your meeting has participants, be sure those extra channels are turned off.

Audio Systems Guide for MEETINGS AND CONFERENCES

Overload /Input Distortion – Extremely loud sound sources can cause overload distortion, also called clipping when placed too close to sensitive microphones. While this is unlikely in spoken word situations, it can happen. It can be controlled by reducing the gain of the microphone at the input, or by moving the microphone and the loud sound source away from each other until the distortion disappears.

Critical Distance: the distance from sound source to microphone at which the direct sound is the same level as the ambient sound. The microphone must be significantly closer than this critical distance in order to be effective. If the sound source is quiet, or if the constant ambient noise level is high, the critical distance is reduced.

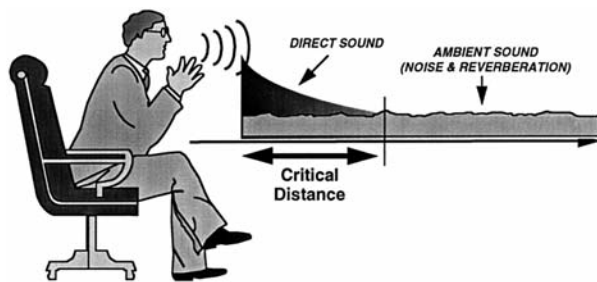

Critical Distance

Microphone Connectors

Every input must be connected to the sound system, typically via a cable. A variety of connectors might be used, depending on the microphone, the destination device, and other factors. While certain connectors are traditionally used in professional microphone applications due to their ruggedness and reliability, the need to interface microphones with consumer devices has led to increasing use of other types of connectors.

Here are the most common microphone connectors you will encounter:

XLR: A positive-lock, 3-pin connector known for its ruggedness, the XLR is almost invariably found in professional microphones. A cable with XLR connectors at both ends (male pins at one end, female sockets at the other) is for a balanced connection. Most XLR cables are designed for low impedance (low-Z) equipment, but there are also high-Z microphones with XLR pins.

USB: The Universal Serial Bus (USB) connector provides the access point for porting audio signals into software programs that handle tasks like recording and editing. Any digital audio that is being sent to a PC or other digital system may use a USB plug.

Today, high quality professional microphones are designed with this in mind, and XLR-to-USB adapters are available to enable traditional mic signals to be used with USB devices.

Phone Plug: Most commonly associated with guitar amps and headphones, the 1/4-inch phone plug might be found on the end of almost any type of equipment, but are mostly associated with unbalanced signals. Phone plugs are also differentiated as either mono (TS, or tip-sleeve) or stereo (TRS, for tip-ring-sleeve), with the latter having an extra division on the physical plug to indicate its extra audio path. In modern sound systems, microphones and mixer inputs using 1/4-inch phone connectors are nearly always associated with high-Z, unbalanced equipment.

Mini-plug: By far the most common connector in consumer electronics, the mini-plug is found on earphones but is also used across a wide range of other equipment, including digital cameras. Most mini-plugs are 3.5 millimeters in diameter (1/8-inch) and almost invariably indicate an unbalanced stereo connection for audio.

RCA Phono: While it is fading from common use today, the RCA plug is primarily associated with consumer sound equipment, and has also found use for carrying video signals. You may encounter RCA plugs on equipment designed for home stereo use such as CD players, amplifiers, and receivers. These plugs are unbalanced and designed with high impedance equipment in mind.



XLR connector

USB connector

Phone plug

Mini-plug

RCA Phono

Microphone Techniques

Proper microphone technique is a critical tool for success in operating a sound system. While the basic principles are universal, different types of microphones require different methods to prevent unnecessary problems. Share these simple tips with users to help maximize sound quality in any meeting or conference situation.

- Speak in a clear, natural voice.
- Aim the microphone toward the mouth and away from unwanted sound sources
- Avoid excessive handling of the microphone, drumming on the table, shuffling papers, etc.



Handheld Microphone

- For a balanced, natural sound, position the microphone 4 to 12 inches from the mouth and slightly off-center to minimize breath noise.
- Being too close to a unidirectional mic causes a boomy sound due to proximity effect. This excessive bass can be controlled with EQ (low frequency roll-off).
- Similarly, speaking too directly into the microphone introduces breath noise. Use an accessory pop filter to control issues from a close-talking user.
- Handle the mic only by its body. Do not grab or cup the microphone grille, as this will compromise its directional properties.



Gooseneck Microphone

- Place the microphone about 8 to 16 inches away from, slightly off center and aimed slightly below the mouth to minimize breath noise.
- Once positioned for the talker, do not touch the microphone or its gooseneck mount.
- Maintain a fairly constant distance for consistent volume.
- Do not tap on or blow into the microphone.

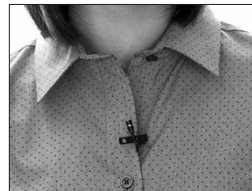

Lavalier Microphone

- Place the mic as close to the mouth as practical, preferably just below the neckline.
- To stay “on mic,” rotate the body rather than turning the head.
- Lavalier mics transmit even subtle noise into the sound system. Once positioned, do not touch the microphone or cable.
- Avoid placements beneath clothing or where anything may touch or rub against the microphone.
- Use a pop filter, especially with unidirectional lavalier mics.
- Avoid direct breath on the microphone.



Headworn Microphone

- Do not place the microphone directly in front of the mouth, which would cause breath noise.
- Position the microphone just off the corner of the mouth, but not touching the face.
- Adjust the headband for a secure and comfortable fit.
- Use a windscreen/pop filter.
- Don't tap on or hold the microphone.

Audio Systems Guide for **MEETINGS AND CONFERENCES**

Microphones – Summary

Even in the relatively predictable world of meetings and conferences, it's difficult to provide a foolproof method for selecting and deploying the right microphone. The information contained in this section should be enough to guide you through most common situations.

A system's sound quality is only as good as its weakest link, so providing clear, high fidelity audio at the inputs is the key to consistent success. Be it ever so humble, the microphone is still the starting point for delivering quality audio.



CHAPTER FOUR

WIRELESS MICROPHONES: THE NEXT LEVEL



Shure ULXD Wireless System

There's one part of every microphone that always seems to be, literally, a stumbling block: the cable. The obvious solution is to go wireless. In some cases, a wireless mic is essential, such as when a presenter needs to move around in front of a screen or white board. Despite their higher cost, wireless microphones are also frequently used on meeting tables because of the cleaner look without cables, and the lack of the need to drill cable access holes in an expensive table.

In theory, a wireless mic is just a regular mic with a radio system substituting for the cable. In practice, of course, "cutting the cord" is significantly more complicated than that, with a wide range of potential audio and radio issues. Using wireless mics can be challenging, especially when multiple systems are used. But the latest generation of wireless mics have gotten smarter and more efficient, making them a solid choice for meeting room audio.

Operationally, most wireless systems are identical, consisting of a transmitter and receiver working together. Each wireless microphone channel must operate on a separate frequency, with the receiver tuned to "hear" only its paired transmitter. The transmitter sends the audio from the microphone over the air on a modulated radio carrier signal, on a specific frequency. At the receiver, the radio signal is demodulated back into an electrical signal and sent to the next stage of the sound system.

Today, there are three primary types of wireless microphones: handheld, bodypack, and tabletop, which are differentiated by the form factor of their microphone transmitters. In handheld systems, the transmitter is integrated as part of the microphone, as seen on stage with countless music vocalists. Bodypack transmitters are designed to be worn out of sight, and are typically used with

lavalier and headworn microphones. Tabletop systems are a relatively new development. They usually take the form of either gooseneck or boundary microphones, incorporating their transmitters into a base that sits on the surface of a table or podium.

Audio issues like occasional dropouts due to radio interference are not acceptable during, say, a presentation by a CEO. Fortunately, such problems can be largely avoided with proper system set-up. With a little knowledge and attention to a few critical details, wireless microphones can be successfully added to any typical sound system.

Frequency Compatibility

Each wireless system must operate on a unique, interference-free channel. The more systems that are in simultaneous use, the more challenging that becomes. Wireless frequencies interact with each other, creating unpleasant audio artifacts. Thus, one of the main responsibilities of the AV manager is to have a protocol in place for frequency coordination.

All wireless systems operate in a specific frequency range, which varies with manufacturer, model, application and location. All frequencies are likely to see interference from competing devices, so it's important to select systems that minimize such potential problems.

The Federal Communications Commission (FCC) defines which devices and services are legal in various frequency ranges, balancing the needs of wireless service providers (Verizon, AT&T, etc.), public safety (fire, police, etc.), traditional users like radio and TV broadcasters, and a wide range of other wireless users. With the boom in wireless usage from broadband Internet providers, cellular phones, wireless home phones, Wi-Fi networks, and other modern conveniences, the competition for wireless spectrum has grown dramatically in recent years. Wireless microphones are a small but important part of that mix.

Currently, the FCC restricts wireless microphone systems to operation within a handful of frequency ranges. Choosing the "right" wireless system depends on the frequency situation in a given facility. If you are considering purchasing one or more wireless systems for your facility, knowing what spectrum is available in your building is of critical importance.

Frequency Coordination

Today's wireless systems are frequency-agile, meaning that they can be tuned to a number of different frequencies within their operating range. This is critical because nearly all legally available spectrum is shared by different types of users and wireless devices. The process of finding and assigning mutually compatible frequencies for all systems in use is called frequency coordination.

Audio Systems Guide for MEETINGS AND CONFERENCES

Most modern wireless systems make it fairly easy to deploy small numbers of systems simultaneously. Still, finding an unoccupied frequency can be a challenge, especially if more than a couple of systems are used. Fortunately, today's wireless systems are generally equipped to help, usually by having the receiver scan the airwaves to find an open frequency. This is always done with the transmitters turned off.

Depending on the system, you may be offered a list of preferred frequencies or channels, or the system may simply give you a single "best available" frequency. The receiver is tuned to this open frequency, and its associated transmitter is then set to match. Depending on the system you have, this might be done by manual selection, via an infrared sync system, or automatically. Once the wireless systems are programmed, they should be tested together in their intended positions with the sound system turned on, to confirm interference-free operation.

Best practices: While it seems logical that the same frequencies that worked today should work just as well tomorrow (and they might!), there are no guarantees. The wireless landscape is constantly shifting. If your wireless system is portable, it is advisable to go thru the set-up procedure each time your system is used in a different room. At the very least, the system should be tested for solid operation prior to the start of a new meeting or event.

Frequency Coordination Tools

If your wireless systems do not offer automatic frequency search and assignment, you will need some additional tools to help ensure effective frequency coordination. Most major wireless manufacturers offer downloadable frequency coordination software or online coordination tools to help identify the best frequencies. Some software can handle frequency coordination as well as real-time monitoring of all receivers. Most such systems are keyed to work only with that manufacturer's devices.

While most manufacturer-based software is optimized for use with their own wireless systems, the fact is that most facilities use only one brand of wireless. However, some companies do offer a more generalist approach, which can be very helpful when adding new wireless systems to legacy products. When considering new wireless systems, take careful note of how well the associated software works with your other equipment.

Professional system integrators often use a frequency scanner augmented by dedicated software to help find open frequencies and avoid intermodulation distortion in their selection. RF scanners take many forms, ranging from dedicated hardware to computer applications.

System Layout

A key operational issue in making sure your wireless systems work properly is the physical layout of the wireless systems within the room – especially antennas. Here are a few do's and don'ts of room set-up to ensure successful operation.

- 1. Maintain line of sight.** While radio waves do bounce off reflective objects, the receiver will get the best results when the transmitter and the receiving antenna can "see" each other.
- 2. Avoid the crowd.** Human bodies absorb radio waves, which can kill transmission at the source. Instruct presenters not to grab any antenna on their transmitter (typically in the base of a handheld). Similarly, best practice is to place receiver antennas up above the crowd.
- 3. Keep antennas clear of obstructions.** Do not try to hide antennas. For bodypack transmitters, do not fold an antenna back onto itself or the bodypack. Each receiver antenna should have a clear view of the stage/transmitting area. Placing antennas in an equipment closet or above the ceiling can significantly reduce their reception.
- 4. Never allow antennas to touch each other.** It's also best that they not touch other objects (especially metal) either.
- 5. Diversity is good!** Most professional wireless systems use two receiver antennas, and either switch between them or combine them for best signal quality. Because each antenna sees a different "picture" of the RF waves in the room, the chance of dropouts is greatly reduced.
- 6. Consider remote antennas.** By extending antennas away from the receiver hardware, you can achieve optimal antenna placement while the main hardware remains safely in a permanent location (say, in an equipment closet).
- 7. Lots of antennas? Combine them!** To avoid having an "antenna farm" at your receiver rack, invest in an antenna distribution system, which allows one pair of antennas to receive signals from several RF transmitters, then send them to their respective receivers.

These simple steps are all based on hard science, and all are designed to maximize the chances of the radio signal being successfully sent and received. By maintaining line of sight between transmitter and receiver, and properly deploying antennas, system operators gain full advantage of the benefits of wireless microphone systems.

Advanced Wireless Concepts

Traditional wireless systems are analog in nature, but most companies now offer digital systems as well. When considering digital wireless systems, remember that they will increase the inherent latency in the audio signal path. Fortunately, today's digital wireless systems are engineered to keep latency issues within acceptable tolerances, even for critical applications like audio and video conferencing, while also enabling a range of other capabilities that will appeal to any IT or AV manager.

Remote Monitoring & Control

Most modern wireless systems are designed to be networked together, enabling multiple system features to be tracked via a browser-based program. Typically, such systems can provide information on each system's operating frequency, RF output, audio output, and battery life. This capability is offered in both analog and digital systems, and enables the facility manager to track system performance from outside the room.

The most advanced wireless systems offer the ability to remotely control the transmitter in real time, adjusting parameters like transmitting frequency, RF power, and audio level. Sending orders to a distant transmitter requires an additional backchannel for wireless communications. Such capabilities are designed for use in complex theatrical or broadcast productions, but have begun showing up in higher-end conference venues and corporate auditoriums.

Encryption

In corporate and government environments, it is wise (or required, such as HIPAA laws and medical privacy) that any audio content remain confidential. For this reason, wireless systems with the ability to encrypt their audio transmissions are highly desirable. Most digital wireless systems are capable of high-security (AES-256 or better) encryption without adding excessive latency.

Rechargeable Batteries

Wireless transmitters require batteries, which is another potential point of failure as well as an operational expense. Commercial rechargeable batteries are an option, but may prove problematic in some models due to variations in their physical size when compared to conventional alkaline batteries.

Some manufacturers are now offering advanced "smart" rechargeable battery technologies that offer significant advantages. These systems provide longer battery life than alkalines while virtually eliminating the environmental impact. In addition, some smart battery systems provide precise indication of remaining battery life in minutes rather than the vague "bars" we normally see.

Maximizing Simultaneous Systems

In a given amount of spectrum, there is a limit to the number of wireless systems that can operate simultaneously without interfering with each other. For budget systems, the maximum might be 10 channels, while professional models might accommodate 50 or more. Some digital systems can be configured for high-density operation, increasing the number of simultaneous systems with a moderate reduction in maximum operating distance. This high-density mode can be ideal for corporate environments.

Final Notes

Wireless microphones come in many shapes and sizes, improving flexibility and aesthetics in any meeting scenario. The critical aspect of their performance is to produce full "wired" fidelity without creating any new issues, such as interference, dropouts, or latency. By choosing appropriate systems and deploying them properly, wireless microphones can deliver exceptional sound quality and outstanding reliability.

Audio Systems Guide for **MEETINGS AND CONFERENCES**

Tabletop Wireless: The New Kid in Town

Traditionally, wireless microphones have always been “only when necessary” items, following the form factor of the handheld, headworn, or lavalier mics they replaced, and being used only when mobility was required. Today’s wireless systems have evolved. They are much more reliable, and are increasingly available in tabletop form factors, including gooseneck and boundary microphone transmitters.



Shure MXW system transmitter

Most tabletop wireless systems also feature advanced designs that include features like network access, frequency coordination, automatic mixing, and advanced rechargeable batteries.

Tabletop transmitters can be extremely convenient in a meeting context, and are quickly becoming the preferred solution in multi-purpose meeting spaces. With full portability, no unsightly cables, and easy mic positioning, it is easy to mix and match transmitters across a wide variety of room layouts. After each use, the transmitters are safely stored out of sight in their charging dock, ready for the next meeting and improving the efficiency of room set-up and tear down. In boardrooms and other high profile installations, tabletop wireless mics are an attractive alternative to drilling through an expensive conference table for cable access.

Protecting Your Wi-Fi Network

Wi-Fi is a great example of why it’s important to know what frequencies your wireless microphone systems use. Many wireless microphone manufacturers offer systems that operate in the 2.4 GHz (gigahertz) range, and advertise them aggressively as globally legal, sometimes even using the phrase “interference free.”

In most meeting and conference environments, there are Wi-Fi data networks in place, and they operate in the 2.4 GHz and/or 5 GHz ranges. Typically, Wi-Fi is used to create local area networks throughout a facility, enabling Internet access and communications. Many devices use Wi-Fi, including computers, smartphones, and other high-tech devices.

Adding wireless microphone systems that will share spectrum with other devices on the Wi-Fi network creates added risk of interference if not properly managed. Within the 2.4 GHz range, there are typically about a dozen usable frequencies for wireless microphones. Some 2.4 GHz wireless systems include the ability to detect and avoid other traffic on Wi-Fi channels automatically, allowing them to co-exist with other network traffic.

Many IT departments regulate all devices that operate in Wi-Fi frequency ranges, to ensure network integrity. Since most organizations consider the uninterrupted operation of the computer network (and the audio system) to be mission-critical, due diligence is advisable when adding wireless microphones in the 2.4 GHz or 5 GHz range.

Wireless Frequencies & The FCC

In the United States, the Federal Communications Commission (FCC) dictates which frequencies are legal for various types of wireless communication. This, in turn, determines which devices and services might be encountered as potential sources of interference. Here is a handy list of the frequency ranges most commonly used by wireless microphones, as dictated by the FCC.

Name	Frequency Range	Operational Notes
VHF TV	174-216 MHz (TV channels 7-13)	VHF systems are uncommon, but legal. New systems in this range are expected to come to market to take advantage of new FCC rulings.
UHF TV	470-698 MHz (TV channels 14-52)	The most popular range for wireless mics, but legal access is shrinking, as the FCC re-allocates portions of the 600 MHz range for cellular and Internet-based technologies.
900 ISM	902-928 MHz	ISM is short for Industrial, Scientific, and Medical – the types of devices that originally used this narrow band. Limited in how many simultaneous systems can be accommodated, but often underutilized in business venues.
1.9 GHz	1920-1930 MHz	The unlicensed 1.9 GHz range is used for wireless call center telephones and similar devices. 1.9 GHz wireless mics use advanced DECT time-sharing technology.
2.4 GHz	2400-2500 MHz	This popular unlicensed band is home to Wi-Fi networks as well as Bluetooth – a significant potential conflict for many facilities. For this reason, it is advisable to avoid using wireless microphones in this range in business environments.

Audio Systems Guide for MEETINGS AND CONFERENCES

CHAPTER FIVE

PROCESSING: FROM SIGNAL TO SOUND

Once the sound has successfully entered the sound system through the microphone, it can be manipulated and combined (mixed) with other sounds. The mixing process ensures that everything can be heard clearly, and may incorporate a wide range of processing tools to reach that goal.

The mixing process can be intimidating. We've all seen the big mixing consoles used in touring sound, measuring several feet across and housing hundreds of knobs, meters, and lights. Fortunately, for voice-oriented content like a meeting or teleconference, things are much simpler. In fact, a well-designed system can literally be fully automatic, with the physical mixer being a simple rack-mounted box with very few knobs.

In this chapter, we will look at different types of mixers and the processing tools used to ensure maximum intelligibility of the mix.

The Mixer

In general, a mixer is an electronic device that combines multiple audio sources, or inputs, in a clear and pleasing fashion. The mixer interface can take many forms, from a large piece of hardware to a virtual control surface on a computer or tablet. Traditional mixers are analog, but digital mixing environments are dominant in new product designs, including tablet-based work surfaces.

The capacity of a given mixer is defined by the number of input channels it can accept. Similarly, the mixer will have a defined number of outputs as well. In between, there are various adjustable features designed to make the mixing process easier and more flexible.

Each input channel of a mixer is designed to ensure that the audio is compatible with the system. This starts at the physical input jack, which will typically be an XLR connector for microphones, and may also have a ¼-inch phone jack for line level inputs. Mixers designed specifically for speech will often have mostly XLR inputs, with a few Auxiliary inputs to handle line level sources via phone, RCA, or miniature input jacks.

Once a sound source is plugged in, the fun begins. First, there will be an input level adjustment (also called gain, or trim) and associated microphone preamplifiers. The goal is to normalize the various sources into the same nominal level – the level at which the signal processors and related circuits are designed to operate – prior to mixing. In some speech systems, input levels are handled automatically.

After input processing and mixing, the audio goes to the output stage of the mixer which sends the audio out to its destination via the Master volume control. For sound reinforcement, the destination is typically the sound system via the power amplifier – often via some additional processing. Many systems require multiple outputs, with the mixer routing the mixed signals to various destinations as needed.

The types of mixers available are as varied as the applications for which they are used. There are mixing consoles designed specifically for use in movie production, studio recording, broadcasting, theater, live music, and our focus of interest, speech reinforcement.

The simplest type is a small utility mixer, designed to combine sources with a minimum of fuss. Typically these are small in size, usually with between two and six inputs, and just one or two outputs. These basic tools of the trade are entirely manual and have just enough features to ensure that any likely sound source can be plugged in and sound good. Thus, you may find inputs for both microphones and line level sources, phantom power for condenser mics, and low-cut filters to control room noise, while EQ or other signal processing will be limited or absent.



SCM268 Mixer

Traditional mixing desks are scaled-up versions of basic mixers. They are generally hardware-based and incorporate a wide range of features designed to deal with virtually any imaginable input and output requirements.

With analog mixing consoles, on-board signal processing is limited to dedicated hardware for each input channel, called a channel strip. Each channel strip typically includes some basic EQ for tone-shaping, mute, pan, and filters, plus one or more Auxiliary Send/Return output loops for the use of external processing devices. Latency is essentially zero in an all-analog environment. (It should be noted, however, that many common outboard effects are digital.) Still popular among traditionalists, analog mixing is a mature technology that is very useful in speech reinforcement.

Current state-of-the-art consoles are fully digital. In essence, they are dedicated computer systems, converting all inputs from analog voltages into digital data streams. This can be a tremendous advantage in a corporate environment, as it opens up possibilities for remote monitoring and control, and enables easy signal transport among multiple locations.

A modern digital console can perform nearly all needed signal processing on board. Digital signal processing is a computer-based technology that has matured enough to minimize latency concerns by keeping the signal in the digital domain as long as possible. Additional processing can also be added at the software level in the form of plug-ins. Channel counts for modern digital mixing systems range from the dozens into the hundreds.

Automatic Mixer

Automatic mixing is the basic building block of many speech systems, enabling “hands off” mixing in speech-based sound reinforcement and in many typical phone conferencing systems. An automatic mixer is faster and more accurate than a human operator, literally using the sound of the voice to turn on the nearest microphone.



SCM820 Automatic Mixer

Once the levels of its various inputs have been set, an automixer uses the voice to trigger microphones quickly on and smoothly off. Automixers reduce the risk of feedback and improve speech intelligibility by minimizing the number of open microphones at any given moment.

The more open microphones in a system, the more indirect sound is fed into it. As the number of open microphones increases, their unwanted redundant signals and inherent channel noise combine to reduce intelligibility due to multiple arrival times. In addition, every time the number of microphones increases, the safety margin before feedback is reduced. To compensate, many automatic mixers add the further refinement of adjusting overall system output to remain constant regardless of the number of mics in use.

Basic automixers might have as few as four microphone inputs, while advanced systems might handle considerably more. An automixer usually takes the form of rack-mountable hardware for the inputs and outputs, and may incorporate sophisticated digital signal processing and routing, often controllable via browser-based interface.

Automixers may also be incorporated within full-featured digital mixers, as part of a multi-effects processor, and most notably within teleconferencing systems, where processing features like automatic input gain control (AGC), adaptive gating, and acoustic echo cancellation are highly desirable.

Signal Processing

Between the inputs and outputs of a sound system lies the world of signal processing. Audio signal processors help solve a wide range of issues, ranging from simple tonal adjustment to feedback and echo control. While it is always preferable to address audio issues with best practices of equipment selection, placement, and deployment, signal processors are valuable tools in overcoming a wide range of problems.

Signal processors include everything from simple volume and tone controls to dynamics effects (gating, compression, limiting), and time-based effects like reverb and delay. These may be contained in a dedicated single-use or multi-effects units, and can take the form of hardware or software. There is another class of special-purpose effects called adaptive processing, which includes feedback reducers, automatic mixers, and acoustic echo cancellers.

Signal processing is usually applied as part of the mixing process, and multiple devices can be combined in series, allowing multiple effects on a single channel, either input or output. While most speech systems have limited processing options, knowing the basic functions of each type of processor is useful.

Volume (Gain) Control

Volume controls are the simplest form of audio processor, used to calibrate the gain structure of the system by aligning the levels of the various devices involved. There are two primary types of volume control: gain controls and attenuators. From the microphone input to the loudspeaker output, volume controls are found throughout the sound system. Most offer continuously variable adjustments using rotary knobs (potentiometers) or sliding faders.

Gain control, also called trim control, adds amplification to the signal to align the mic's output to the sensitivity of the input channel. An attenuator is a subtractive device that is used strictly for reducing the amount of signal allowed to pass through.

Audio Systems Guide for MEETINGS AND CONFERENCES

A “pad” is a specialized version of an attenuator, usually in the form of a button or switch, used to prevent a high output device from overloading the input of the next device. A good example is a mixer input, where a 50 dB pad can be used to make a line level source work with a mic level input channel.

Equalization (EQ)

Among the most common types of signal processing, equalization uses filters to change the frequency response of a signal. Equalizers may take the form of a simple tone control (like the Bass and Treble controls of a stereo system) to broadly affect response, or may involve several precision filters working together to achieve very specialized changes.

To understand equalizers, a little knowledge of filters is required. There are four types:

High pass (low cut) – allows high frequencies to pass, rejecting all lower frequencies

Low pass (high cut) – allows low frequencies to pass, rejecting all higher frequencies

Band pass – allows a certain range of frequencies through, rejecting everything above and below the passband, as if using a low cut and high cut filter together.

Band reject – the opposite of a band pass filter, it eliminates a frequency range while allowing high and low frequencies through.

Low and high cut filters have an associated “slope” that defines how rapidly output declines below (or above) the filter frequency.

An equalizer is a device with a combination of filters to enable precise control of frequency response. There are two primary types of equalizers: graphic and parametric.

Graphic Equalizer

So called because its knob positions offer a visual approximation of frequency response, a graphic equalizer consists of a bank of faders (sliding knobs) with center frequencies typically covering the full audio frequency range. Each slider starts at a flat (neutral) setting of 0 dB, and can be moved up (boost) or down (cut) to change the response around its center frequency. The resulting “graphic” of the fader positions makes the operation of these devices fairly intuitive.

Graphic EQs may be encountered as analog hardware devices, or in virtual form within a digital device or software.



They may have as few as five sliders or as many as 31 (called a 31-band, or 1/3-octave graphic EQ). The more sliders, the more precise the control. The center frequencies of a graphic EQ are defined by ISO standards and thus consistent between manufacturers. The boost/cut range of each slider is typically +/- 12 dB.

It's important to realize that EQ effects are additive so that changes to one frequency range will have some effect on adjacent frequencies. The amount of interaction between adjacent frequency bands varies with the slope of the EQ's internal filters. Thus, a troublesome frequency that lies between two bands can still be changed by using the two adjacent knobs together. This interaction also means that changes to the frequency response are more complex than indicated by the slider positions. This can be shown on a measurement device like a Real Time Analyzer (RTA). For general purposes, however, it's sufficient to realize that too much EQ can cause unnatural response, and to use your ears as well as your eyes when making adjustments.

Parametric Equalizer

Designed for precise control of specific frequencies, the parametric EQ is one of the ultimate audio problem-solvers. Rather than a single slider per center frequency, a parametric equalizer has three controls per filter: boost/cut, sweepable center frequency, and filter bandwidth.

A good parametric EQ allows the user to tune to the exact center frequency needed, and can narrow the filter's bandwidth to focus on a specific frequency with little audible effect on adjacent sounds. Conversely, choosing a wider bandwidth allows more frequencies to be intentionally cut (or boosted), but at a center frequency of the user's choosing.

A hardware-based parametric equalizer offers around six full adjustable filters, primarily due to space requirements of the hardware. Software-based parametrics are more flexible, employing as many filter sets as the device's

processing power permits. In addition, many digital parametrics often offer real-time analysis, allowing the user to see a graphic representation of EQ effects on frequency response for more precise control.

Parametric EQs are best suited for tasks like elimination of irregularities in response caused by microphones and loudspeakers. Because they are so precise, parametric EQs are also ideal for eliminating the exact frequency at which feedback occurs.

Feedback Reducer

When acoustic feedback happens, it takes a skilled sound engineer with either a well-trained ear or special analysis tools to identify the frequencies involved and remove them from the mix. A feedback reducer (also called a feedback eliminator or suppressor) handles it accurately, quickly, and automatically.

A feedback reducer is a digital device that uses a detection algorithm to identify feedback by looking for any constant or growing sound at a single frequency. Once the presence of feedback has been detected, the feedback reducer engages and tunes a filter to the offending frequency, reducing it until it stops the feedback. Because their filters can achieve a bandwidth as narrow as 1/70th of an octave – a band-reject filter, sometimes called a notch filter – feedback reducers can eliminate offending frequencies with negligible effect on the overall mix.

Having a feedback reducer as part of a speech reinforcement system can prove invaluable, flattening the overall system response and potentially adding 6 to 10 dB in system gain before feedback. The reducer typically contains a bank of ten or more filters, protecting the system from further feedback. However, as more and more filters are engaged, the overall sound quality tends to grow increasingly unnatural.

Feedback filters are adaptive, not predictive. This means that actual feedback must be present before they deploy. Using a feedback reducer in a music mix is not recommended, as any sustained note will trigger the system.

It is important to recognize the fact that these devices treat the outcome, not the cause of feedback. If your feedback reducer is in constant use, there are problems with the sound system's design and deployment that need to be addressed separately.

Dynamics Processing

The difference between the loudest and quietest level of a signal is called its dynamic range. Dynamics processors are used to manipulate level variations in a signal to increase audibility and reduce undesired noise, or

to accommodate the limitations of other equipment. Like most of the other devices we've discussed, most dynamics processors are available as standalone devices, but today they are often contained within a multi-effects DSP device, software plug-in, or system processor.

Compressor

A compressor reduces a signal's dynamic range, effectively reducing the volume difference between the loudest and quietest signals. This is done by reducing the level of all signals above a specific, user-defined threshold by a specific amount. All signals below the threshold remain unchanged. The amount of reduction is expressed as a ratio. The higher the ratio, the more volume reduction is applied to loud signals.

For instance, a compressor set to a 2:1 ratio would take a signal that is +10 dB above threshold and reduce it by 5 dB. If the setting was 5:1, that signal would be divided by 5, resulting in a reduction from +10 dB over the limit to +2 dB, resulting in a much smaller dynamic range.

While some compressors employ presets to address common situations, most include settings for attack, sustain, decay, and release. These controls adjust how quickly the compression takes place and the time it takes for the compressor to return the signal to its original value. Longer attack times sound more natural but might miss signals that should be compressed, while fast attack times are more effective in stopping loud transients. Release times can be similarly delicate, as a short release time can result in a "breathing" or "pumping" sound, while a long release can result in quiet passages being missed because gain reduction is being applied.

Limiter

Like a compressor, a limiter reduces signals above a specific threshold by a certain ratio. The difference is that limiter ratios are extremely high, starting at 10:1 and reaching infinity (meaning that the threshold = the maximum level). Limiters are used to prevent distortion and to protect the sound system components, especially loudspeakers, from damage by unusually loud transient signals.

Where a compressor is designed to increase intelligibility by controlling dynamic range in a natural-sounding way, limiter effects are more severe, allowing very little (if any) audio above the threshold. Where a compressor acts as a sort of elastic limit on loud sounds, pushing them down to safe levels, a limiter acts more like a hard ceiling.

The goal of the limiter is not to affect the audio signal unless absolutely necessary. For this reason, they are often used as the last device in the signal path, a last resort against potentially damaging levels in a system.

Audio Systems Guide for MEETINGS AND CONFERENCES

Noise Gate/Expander

An expander, as the name implies, functions as the reverse of a compressor by expanding the dynamic range of an audio signal. Used together, a compressor and expander form a compressor, a circuit commonly used in noise reduction systems and wireless microphone systems, allowing a signal to be compressed for a specific purpose, then returned to its original dynamic range.

For sound system applications, the downward expander can be used to reduce unwanted background noise when there is no program material present. This is especially useful for controlling the audible effects of multiple open microphones. When the level drops below the threshold, the output is essentially turned off (or "gated"), preventing build-up of undesired noises. This circuit – the downward expander – is used in many automatic mixers to silently and smoothly minimize the number of open microphones by gating them off when not in use.

Automatic Gain Control (AGC)

Also called a speech leveler, the automatic gain control (AGC) either adds or reduces gain, depending on the strength of the incoming signal. A properly adjusted AGC helps compensate for differences in level between loud and soft talkers, making it one of the few processors to actually raise the volume. Automatic gain control does this by raising the level of the input signal of low-level sources, increasing audibility over the entire presentation.

The key setting on an AGC is called the hinge point. Gain is added to signal levels below the hinge, while signals above it are attenuated. At the hinge point, the signal is at the desired output for the given sound source. This target level is the unity gain point, where no addition or subtraction of gain occurs. The hinge point volume is set at the desired output, or target level, for the given sound source. The threshold sets the level where the AGC begins to take effect.

Similar to the compressor, the attack setting adjusts the speed at which the AGC takes effect, and decay sets how long the AGC takes to release. When used to make gain adjustments for different talkers, using longer attack, hold, and release times results in smoother transitions and less false triggering. To use an AGC, the sound system must have high enough gain-before-feedback to accommodate the maximum gain setting of the AGC.

Acoustic Echo Cancellation

The acoustic echo canceller (AEC) is an adaptive processing device designed specifically for use with audio and video teleconferencing systems. In these systems, a distinctly perceptible echo can be caused by several sources of delay in the signal chain, and can be extremely disruptive to the smooth flow of conversation.

Acoustic echo occurs when audio received from the remote site reaches active microphones at the near site, and is thus transmitted back to the remote site along with sound from the near site talkers. To address this type of echo, an

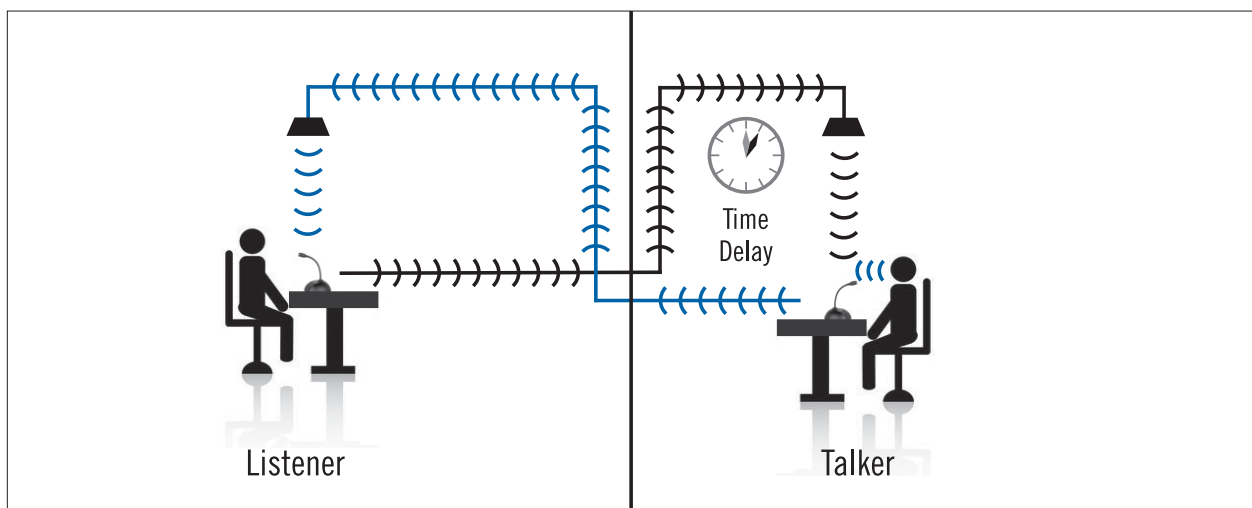

Echo occurs when the sound from the talker is picked up by the listener's microphone, and transmitted back to the talker.

Audio Systems Guide for MEETINGS AND CONFERENCES

AEC monitors the incoming audio signal from remote sites and compares it to the signal that is about to be transmitted. If the echo canceller detects the presence of the incoming audio within the outgoing signal, it attempts to remove it electronically by subtracting it from the return audio feed.

The echo canceller attempts to prevent the incoming audio from other sites from being sent back to them, which means that it improves audio for the remote site, not the one where the unit is installed. To address echoes locally, the distant site's teleconferencing system would require an AEC as well.

In recent years, powerful processors and advanced cancellation algorithms have made acoustic echo cancellers more effective and less expensive. Thus, most teleconferencing systems now come with AEC capability. These vary in their power and effectiveness, depending on whether they are designed for single-user laptop systems or complex multi-user meeting rooms. In larger rooms with multiple microphones and loudspeakers, it is desirable to have a separate echo canceller for each mic in the teleconferencing system, providing optimum echo reduction.

Finally, please note that acoustic echo cancellers are

single-purpose devices. They are not designed to address audio issues such as acoustic reverberation within a reflective room. In fact, excess reflective sound makes it difficult for the echo canceller to work properly.

Delay

Another type of audio signal processor works in the time domain, delaying the audio signal by a user-defined amount. In speech reinforcement systems, the primary function of a delay unit is the time alignment of loudspeakers. By delaying the signal from secondary speakers to match the arrival time of sound from the main PA, degradation of sound quality due to audible echo, comb filtering, and other artifacts can be minimized.

There are many other uses for time-based signal processing, primarily in music. While the need for time-based DSP is unlikely in typical meeting and conference rooms, delay effects can be a valuable tool and are commonly available within multi-effects processors.

As with all audio processing, a room outfitted with proper acoustic treatment, and a properly deployed sound system should be used as a starting point before attempting to fix audio problems electronically.

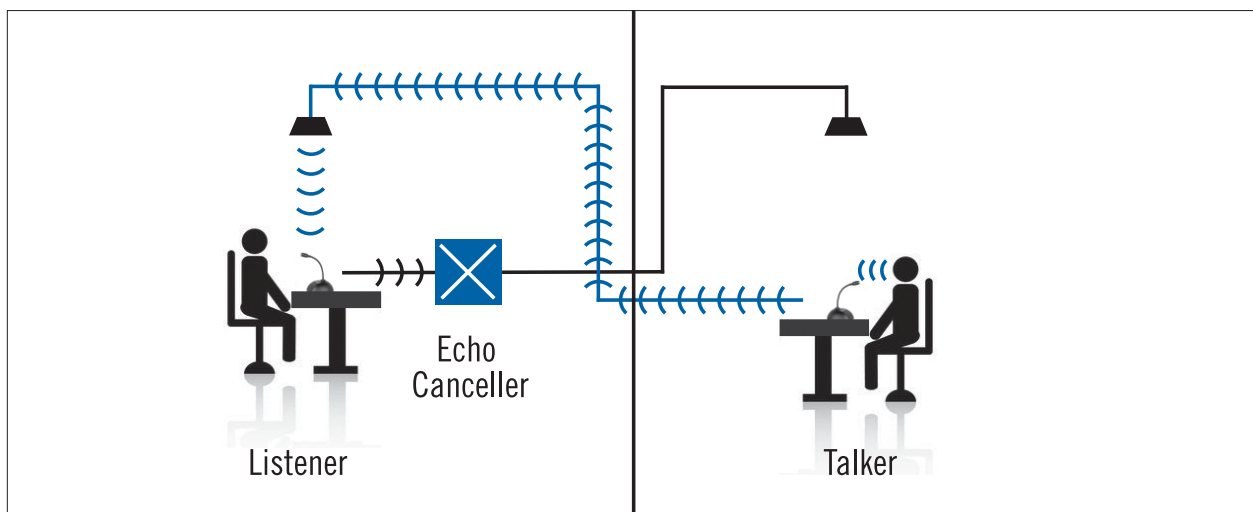

An echo canceller prevents echo by eliminating the far talker's voice from the listener's outgoing audio signal.

Audio Systems Guide for MEETINGS AND CONFERENCES

CHAPTER SIX

AUDIO NETWORKING & CONTROL

Increasingly, today's audio/video landscape involves the operation and control of systems in conjunction with an organization's computer network. Advanced needs like multi-site meetings, archiving of content, recording and streaming require a degree of connectivity and flexibility that traditional audio systems cannot provide. Remote monitoring of system status is another highly desired capability.

Traditional audio is a closed system with its own connections and signal topology. As professional audio has become increasingly digital, systems have evolved to enable connection over a variety of network-based protocols, resulting in simplified transport and sophisticated monitoring and control of audio systems.

The goals of audio networking are fairly uniform: to bring real-time audio (and video) into alignment with Internet Protocol. The starting point for that is connectivity, with multi-channel transport via Ethernet cables, providing high bandwidth and the ability to transport hundreds of channels.

There are several distinct types of audio networking available, with varying degrees of interoperability and ease of use. Older systems require their own infrastructure, and tend to be digital versions of traditional audio's point-to-point connectivity. Today's audio networking protocols have progressed far beyond that, with both audio distribution and device control working together over Ethernet connections over many channels. Today's digital audio protocols are fully IP compliant, with the ability to operate over the same IP network that carries the rest of the organization's digital computing needs.

Such systems meet AES67 standards' Layer 3 protocols and use IP packets for transmitting audio and related metadata. Thus, both control data and actual audio can travel the network together. There are several proprietary commercial systems operating at this level, including Dante™ (by Audinate®), Q-LAN (by QSC®), and Livewire (by Axia®), which share the ability to pass their data through a network router with native support. Over 150 pro audio companies are using Dante as their networking protocol, and its developer, Audinate, has committed to ensuring that it will be compliant with Audio Video Bridging (AVB) standards currently being developed by the Audio Engineering Society (AES) to help synchronize video to audio in a digital network context.

Two Kinds of Networking

There are two major considerations in audio networking: device control and audio distribution. When used for monitoring and control of A/V devices, data communication

has great applications within an organization. Some wireless microphone systems, automatic mixers, and discussions systems offer remote access of many system functions. By logging in remotely, it becomes possible to monitor a piece of equipment and see its status, including key information like battery condition, wireless frequency, or other system settings. The ability to monitor and control systems remotely can save the IT department valuable time in room setup and troubleshooting.



Wireless Workbench®

The second type of networking involves the audio itself. Once the sound system's output is available in digital form, it can be routed anywhere within a facility, linking multiple rooms together. Additional operations such as Internet streaming or multi-track recording can also be accommodated, allowing meetings to be archived, backing up the audio stream to a server or cloud service.

Properly implemented, digital audio networking is fast and efficient, enabling the A/V operator to handle routing, distribution, and monitoring of major system functions via the IP network. Audio can be duplicated and routed to any number of locations without quality loss, with wide audio bandwidth, high channel counts, and relatively low latency. At the same time, Ethernet connectivity can provide remote access to a variety of system control functions for networked devices.

This enables the AV technician to focus on proper audio system setup before the meeting, greatly reducing the need to personally supervise the meeting space. By producing quality audio through proper selection and placement of microphones and loudspeakers, a digitally networked audio system will provide highly intelligible audio that can be seamlessly controlled and transported over the IP networks as needed.

If your organization is considering new audio systems, it is highly recommended that products offering IP-based network connectivity of both audio and control information be considered. This will enable seamless integration of audio and video into existing (and future) IT infrastructure.

CHAPTER SEVEN

THE ROOM'S THE THING

The optimal audio solution for any given meeting depends on a wide range of factors, including the size of the room, the number of people involved, the number of presenters, and the style of presentation.

The biggest factor in microphone selections is whether or not a sound reinforcement system is involved. Another major consideration is presentation style:

- One-to-many: one person addressing an audience, such as a lecture
- Many-to-many: all attendees speaking at will, as an open forum
- Hybrids: special cases of many-to-many communication with restricted or prioritized microphone access. Examples include city councils, courtrooms, boardrooms, and panel discussions with an audience.

As a starting point, it's useful to categorize by room type, with typical microphone suggestions for usage in corporate or organizational environments.

Huddle Room



This is a small room that accommodates 6-8 people, usually around a single table. In general, there is no need for sound reinforcement in basic meeting spaces. However, many huddle rooms do incorporate audio or video teleconferencing, which may be a permanently installed or portable system on a rolling cart.

Because there is no PA system involved, this is a perfect situation for an area miking approach. The only microphone requirement is to avoid being too close to the loudspeaker from the teleconferencing system. If the system does not have its own dedicated microphones, try placing a couple of boundary microphones – wired or wireless – on the table. This is also a situation where 1-2 small condenser microphones hanging a few feet above the table can be useful.

Meeting Room



A larger version of a huddle room, the meeting room may accommodate between 6 and 30 people at one or more large tables, often seated “in the round” so that everyone can see each other. If the room has well-controlled acoustics (not too reverberant), sound reinforcement may not be required. However, both recording and teleconferencing are common in meeting rooms, which means that microphones will be required.

Whenever four or more microphones are used, it is strongly recommended that there be some way of turning off unused microphones. The easiest way is to use microphones with integral on/off switches and rely on the presenters to operate their own microphones. Another strong possibility is a dedicated discussion system or automatic mixer, which removes that burden from the participants, improving focus on the meeting itself. A discussion system has the advantage of integrating a small sound system into each microphone station, virtually eliminating any chance of feedback.

Most people gravitate to having one tabletop microphone per participant, but one microphone for every two people is often sufficient. Gooseneck microphones on the table are the preferred option in meeting rooms, although boundary microphones can also be used. If the tables are movable, wireless tabletop microphones can provide flexibility and speed of setup. A discussion leader is a good candidate for a headworn or lavalier wireless microphone.

Training Room/Classroom



Audio Systems Guide for

MEETINGS AND CONFERENCES

This is a classic one-to-many communication scenario, with up to 30 students at chairs or tables facing the instructor/lecturer. The larger and more reverberant the room, the more need there is for a sound reinforcement system at the front, facing the learners. Smaller rooms that do not require a sound system may still need miking to feed streaming, videoconferencing, and/or recording of the presentation. Maximizing intelligibility is critical in any learning environment.

The lecturer may work from a podium, but is more likely to move about during the presentation to use a blackboard, whiteboard, or other tools. To accommodate this need for hands-free voice pickup, a headworn or lavalier wireless microphone is the preferred solution.

Student questions can be fed into a distant learning link in a number of ways. A dedicated microphone can be placed at a specific table for this purpose, or a handheld wireless can be passed around as needed. Overhead miking of the seating area should only be considered when no sound reinforcement system is involved, and only in rooms with good acoustics. If the class experience is intended to be highly interactive, consider a system of desktop microphones with an automatic mixer or discussion system.

Lecture Hall



In essence, a lecture hall is a larger version of a classroom, with an audience of 50 or more. Larger facilities seat over 200 people and often have tiered, theater-style seating. A lecture situation does not accommodate miking for all audience members, and a PA system designed for high intelligibility is definitely required. Fortunately, lecture halls are relatively stable in their usage, allowing dedicated system design.

As in the classroom, a lecturer is best served by using a wireless lavalier or headworn microphone to keep both hands free, or a gooseneck or stand-mounted microphone at a podium. If it is unlikely that the instructor will be actively using visual aids, a handheld wireless is also an excellent option.

Student input is more challenging in lecture halls, since both students and the instructor may have difficulty hearing questions. This is an ideal situation to use one or

two dedicated microphone stations in the aisles, placed in positions where the threat of feedback is minimal. Alternately, a handheld wireless microphone can be passed around. Despite being on the “wrong side” of the PA system, a handheld should be close enough to the talker to be relatively safe from feedback.

For the instructor, consider providing a dedicated monitor speaker specifically for questions from the audience in the room and in distant locations if needed. As previously discussed, overhead microphones can be problematic in picking up audience questions in a sound reinforcement situation unless the output is safely routed to avoid feedback issues.

Specialized Spaces

Of course, not all spaces follow the above models. Some have very specialized user requirements, which are reflected in the sound systems they use.

Videoconferencing



Videoconferencing systems allow two or more distant locations to communicate with simultaneous audio and video transmissions over telephone lines or broadband network connections, allowing multiple groups of people to interact in real time, and are useful for both meetings and education. There are two primary types of systems: dedicated and desktop, and they can be based on either traditional telephony or an enterprise VoIP system.

By their very nature, videoconferencing systems involve sound reinforcement of the audio from the distant site. Technologies like automatic mixing and acoustic echo cancellation (AEC) are usually included. These building blocks are usually present, whether it's a single-use desktop system, a portable cart-based system for small meeting rooms, or a permanent system in a dedicated videoconferencing room.

Modern videoconferencing is fully digital, using compression technologies to coordinate the audio and video streams in real time for transmission over a data network. In addition to live audio and video in the participating rooms, the content may also be ported as a data stream for archiving.

Audio Systems Guide for MEETINGS AND CONFERENCES

The audio part of a videoconferencing system follows the function of any typical meeting room, often with pre-selected speaker systems and microphones. As with any sound system, care must be taken to maximize intelligibility and minimize unwanted ambience. When setting up a teleconference, use solid techniques for microphone selection and placement. Wireless microphones can be incorporated as well, eliminating unsightly cables while adding mobility.

The biggest audio problems in videoconferencing tend to be related to microphone placement. Distant mics produce a hollow, indistinct sound and increase the potential for echo problems. Placing microphones within arm's reach of all participants is a good guideline for improving sound quality, and has the added benefit of improving the performance of the system's acoustic echo cancellation (AEC).

In general, treat a teleconference like any other live sound reinforcement situation, with added awareness of the importance of minimizing the visual footprint of the microphones due to the video aspect of the meeting.

Boardroom



A boardroom is not unlike a standard meeting room, but incorporates turnkey control systems to enable participants to focus on the proceedings rather than the AV equipment. Typically, a control system, such as those made by AMX®, Crestron®, or Extron®, is programmed by the room designer to enable any needed equipment through a single touchscreen remote control. Any sound reinforcement is usually limited to videoconferencing systems and playback systems for video.

Microphones are common in boardrooms, both for teleconferencing and as a means of recording the proceeding for archival purposes. Automatic microphone systems are popular in boardrooms, as they ensure full capture of the proceedings without the need for a system operator in the room.

In a boardroom, aesthetics are always a major consideration, particularly in mic selection and placement. Permanent microphones may pose a challenge, as they

require drilling through expensive conference tables to run cables. For this reason, tabletop wireless microphones are becoming very popular in the boardroom – especially models that offer audio encryption – as they eliminate unsightly cables, preserve the conference table, and can be quickly removed when not in use.

City Council/Courtroom/Large Meeting Facilities



The bigger the meeting facility, the greater the need for advanced systems. With a chairman presiding over a large group like a city council, usually with an audience gallery, a comprehensive sound system with advanced features is required. International conferences are even more demanding, with interpretation capabilities often needed.

Such facilities have complex requirements, including the need for participants to hear each other across the room, for the audience or gallery to hear everything, and of course the need to maintain some semblance of order with so many participants. Sound systems must be carefully designed, with multiple destinations including monitoring for the participants, a PA system for the audience, and separate feeds for recording, for the press, for cable broadcast and streaming, etc.

Automatic microphone systems are a starting point. The ability to minimize the number of open microphones by turning them on only when the participant speaks, then smoothly off when not in use, helps maintain intelligibility while ensuring that all talkers are heard. In addition, many automatic microphone systems include logic switches to create priority for the chairperson's microphone.

Many installations can benefit even further by using a discussion system or conference system. These systems address one of the biggest problems of sound reinforcement for meetings by incorporating a small loudspeaker into the base of a tabletop gooseneck microphone. By placing these miniature sound systems in front of each participant, it ensures consistent sound quality for all. In addition, discussion and conference systems are almost uniformly digital, can be operated by non-technical users, and can be scaled up to accommodate virtually any size of gathering.

Audio Systems Guide for MEETINGS AND CONFERENCES

Miking The Audience

There are a number of common scenarios where an A/V tech is asked to mic the audience. This is most often done to accommodate questions in situations where those across a large room (or at the other end of a teleconference) may have trouble hearing the questions being asked due to the distances involved and/or poor room acoustics.

The most universally effective approach is to provide a microphone channel specifically for the audience. In this scenario, a microphone can be set up at a dedicated Q&A station, or a handheld wireless microphone can be passed around the audience, preferably with the help of a moderator.

Another method is to attempt to mic the entire audience with overhead area microphones. This technique is very limited if a sound reinforcement system is involved, as additional open microphones will introduce unwanted noise into the system and create more opportunities for feedback. However, if the audio from the overhead microphones is only being sent to a distant site, as in teleconferencing or multi-site lecture scenarios, it can be effective.

When using overhead miking to cover the audience, remember the 3-to-1 Rule: The distance between open microphones should be at least 3X the distance from each mic to the nearest talker, activate the mics only when in use, and add only enough gain to achieve the goal of being heard. In larger rooms, the sound system output can be split into zones, allowing the loudspeakers covering the area where the questioner is seated to be muted.

The audio control challenges of audience miking can be considerable. The best options are to either bring the microphone to the people, or bring the people to the microphone. The trick is to do so without compromising the intelligibility of an otherwise effective sound system.

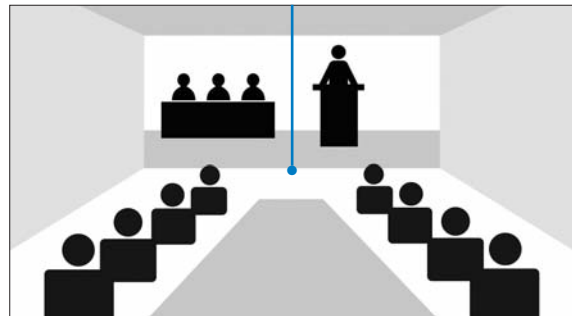

 **Bad:** A single hanging mic is generally *not* enough to capture audience questions and comments.

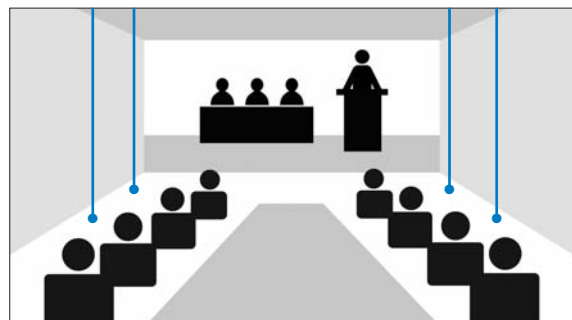

 **Good:** Using multiple hanging mics is a good solution for capturing audience questions and comments.

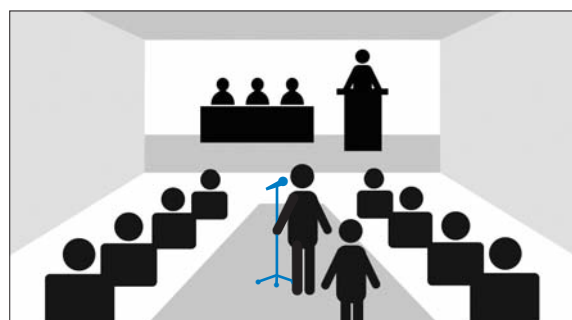

 **Good:** A common and effective solution for capturing audience questions is to place a wireless microphone on a stand in the aisle. (You can also have a staffer bring the wireless microphone to audience members, so they do not have to leave their seats to ask questions.)

CHAPTER EIGHT

MULTI-PARTICIPANT SOUND SYSTEMS

Many meetings are based on a “one-to-many” model, such as a presentation or lecture. The sound system distributes the voice of one talker (or just a few) in the front of the room to listeners in the audience. Most of the time, no one in the audience speaks, so they are not covered by microphones. A traditional sound reinforcement system – with a microphone for each talker and loudspeakers mounted on the walls or ceiling, or a portable system on floor stands – works well in these types of meetings.

But some meetings use a “many-to-many” format, often with a round, oval, or square table with seats around the outside. At these meetings, everyone is both a talker and a listener, and needs to be able to speak and be heard by everyone else. It’s more difficult to use a standard sound system in such meetings, because the room layout ensures that any standard sound system will be problematic, as some of the loudspeakers will inevitably end up pointing at the microphones. This makes feedback much more likely, and can be distracting because the talker’s voice may be coming from behind the listener.

Another tricky scenario is in a training room. Although this uses the standard presenter-in-the-front layout, it’s possible that the students will frequently ask questions that need to be heard by listeners in another room, either watching a live stream or actively participating via a videoconference. If the room is fairly large or noisy, it can be difficult, even for students in the same room, to hear the

questions that other students are asking. In adult education or corporate training situations, that can significantly impede needed interactivity.

Situations like these – where everyone talks – often benefit from a different approach than the traditional sound reinforcement system.

A Sound System Designed For Multiple Participants

There are specialized digital audio systems designed specifically to overcome the challenges mentioned above. These ‘discussion’ or ‘conference’ systems combine the microphone, controls, and a loudspeaker into a single integrated unit, with a central control module providing control functions via a laptop, table, or smartphone connection.

Instead of each microphone connecting to a mixer, discussion units connect together serially, in “daisy-chain” fashion, using shielded CAT5e cables instead of conventional microphone cables. A central control unit at the head end powers each microphone/speaker station and handles all of the audio routing and control.

A discussion system is a series of self-contained sound reinforcement systems: each unit includes a microphone, a small power amplifier, and a loudspeaker. The power supply and brains of the system are all contained in a dedicated central control unit that sits in a closet or cabinet. Because the microphone modules connect together in a daisy chain, in most cases only one cable needs to lead back to the central unit. The central unit also provides inputs and outputs to connect to additional audio equipment, such as

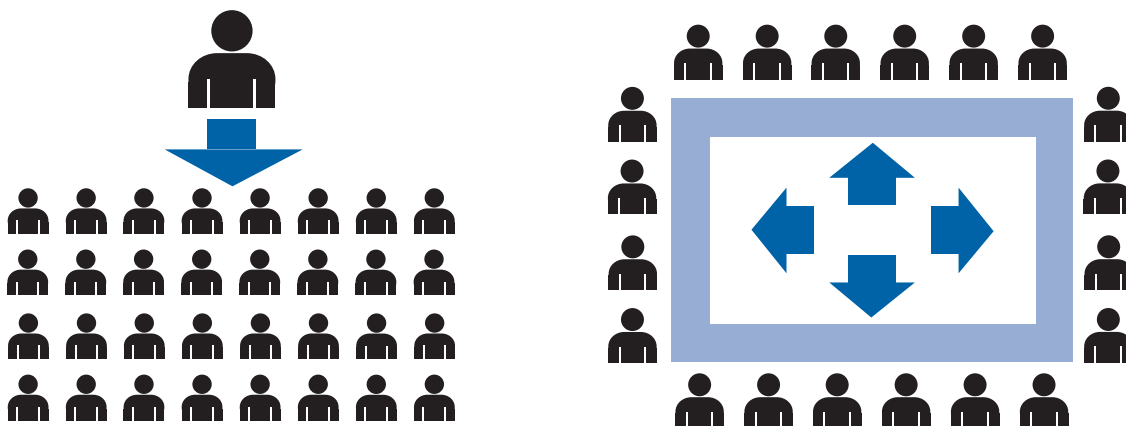

One-to-many vs. many-to-many meetings require different audio solutions

Audio Systems Guide for MEETINGS AND CONFERENCES



DDS 5900 Digital Discussion System

a wireless microphone for a presenter, an audio feed to and from a videoconferencing system, or a MP3 player or other external source.

A discussion system offers several benefits that make it an excellent solution for meetings with multiple talkers:

Sound quality: As we've already learned, one of the most critical factors in delivering clear sound without noise or feedback is the distance from the microphone to the talker. A discussion system provides a gooseneck microphone for every participant, putting them within about two feet of the mic. This insures that the mic picks up significantly more of the direct sound from the talker than reflected sound or background noise.

Because the discussion unit also houses the loudspeaker, each participant is close to a loudspeaker, too. That makes it easy to hear clearly – even in rooms that are relatively noisy or reverberant – without turning up the volume loud. To prevent feedback, the loudspeaker in the discussion unit is automatically muted whenever its microphone is active.

Flexibility & Control: Unlike a traditional sound reinforcement system, a discussion system is designed to accommodate a variety of meeting styles. For example, a discussion system can operate in 'push-to-talk' mode, where participants activate their own microphones by pushing a button. Or, the system can be set so that microphones are

voice-activated to allow greater interactivity. Either way, the maximum number of active microphones can be limited to just a few, to help maintain order. In addition, each microphone sports a "light ring" around the capsule, making it easy for everyone to see who is speaking.

In more formal meetings, the system can be set up so that participants must push a button to electronically 'raise their hand' and wait until their mic is activated by the meeting leader, who enables their microphone by pushing a button. With an Ethernet connection to the central unit, the entire system can be controlled by a third-party room control system or via a tablet, PC or smartphone using browser-based software.

Scalability: Discussion systems are designed to handle anywhere from a handful to hundreds of microphones, making them suitable even in large rooms. Even such large systems only require a few 'branches' of daisy-chained units. A discussion system can also be combined with other audio equipment, such as one or more wireless microphones for instructors or presenters on the input side. On the output side, an audience PA system, live web stream, videoconferencing system, or recording system is easily accommodated.

Multiple Languages: Some discussion systems also allow for simultaneous interpretation. In this case, one or more interpreters sit in isolation booths, listen to what is

Audio Systems Guide for MEETINGS AND CONFERENCES

being said, and translate it into another language in real time. Their audio goes to the central unit, where the feed for each language is programmed and routed to the destination units, where the participants listen through headphones attached to their individual base stations.

Digital Networking & Connectivity: Most multi-participant dedicated systems are fully digital, allowing easy signal transport between multiple rooms, connectivity to other digital systems, and remote monitoring via the company's IP network. In addition, most such systems offer secure audio transmission by encrypting the signal to prevent electronic eavesdropping.

Discussion Systems vs. Conference Systems

So far, we've been referring to "discussion" systems. A "conference" system has even more capabilities, building on the capabilities of a discussion system, but with more features designed specifically for organizations like corporate boardrooms, city councils, and associations or non-profit organizations. These groups are often legally required to (or may just wish to) document their proceedings beyond audio capture, to include documented minutes on who attended, what was on the agenda, and the outcomes of discussion, including votes. A conference system automates those functions, and expands on discussion systems with even more scalability and expanded ability to prioritize microphones.



Touchscreen Conference Unit With ID Card Capability

Attendees: Some conference units include a touchscreen where participants can enter an ID using a PIN code, or slot for an identification card. Inserting the card or entering the code tells the system who is present and where they are sitting. When that person's microphone is activated, the system can keep track of who spoke and for how long.

Agenda: Before the meeting, the agenda can be entered into the conference system's meeting management software via computer, typically using browser-based software. As the leader selects each agenda item for discussion, the system can keep track of who spoke about that topic.

Voting: In corporate boardrooms, city councils, or other governing bodies, it's often necessary to enable participants to vote electronically, and provide an automated means of recording and displaying the results. In training rooms and lecture halls, it can be useful for the instructor to have a means of polling or testing the students to check how well they understand the material being presented. Some conference units include a touchscreen or buttons for this purpose, and optional software that tallies and stores the results.

More Languages: While most meetings in North America can be accommodated with one or two additional languages, international conferences often require many more languages. A conference system generally can distribute 20 languages or more to each participant.

The unique features and capabilities of discussion and conference systems make them an outstanding solution for meeting rooms where everyone is both a talker and a listener, a situation that makes using a conventional sound system problematic. These systems are easy to install and use, offer great sound with virtually no chance of feedback, and offer the additional benefit of being fully compatible with any typical computer network.

CHAPTER NINE

CONCLUSION AND APPENDICES

We live in an increasingly digital world, but the human voice is inevitably analog. The key to clear, consistent communication in any meeting or conference scenario is knowing and using the best practices for the selection and deployment of microphones and loudspeakers, ensuring robust, intelligible sound for all participants.

There's a classic saying in computer science that applies equally well to audio: Garbage In, Garbage Out, often referred to as GIGO. Just as computers require accurate data to produce the correct results, a sound system is only as good as the quality of the audio inputs it receives. Only with proper microphone selection and use can the sound system deliver consistent, highly intelligible audio. This is especially true in any sound reinforcement scenario.

We've tried to provide you with the tools for maximizing

the clarity and intelligibility of the spoken word. By selecting appropriate microphones and deploying them in a manner that maximizes the desired sound while minimizing unwanted noise and reverberation, you can change the meaning of GIGO to a positive one: Great Input, Great Output.

Modern sound systems can convert audio into digital data for monitoring, control, and transport. But even the best digital tools cannot repair intelligibility that is lost at the input stage. Only with high quality inputs can the rest of the sound system, from mixer and signal processors to amplifiers and loudspeakers, do their jobs effectively.

It is our hope that the information in this book has provided a foundation of knowledge you can use to deliver outstanding audio in your organization's meetings and conferences.

Outside Resources

This book is written specifically for organizations that utilize audio in meetings and conferences, but whose technical staff is geared more toward information technology. For more assistance – especially if a system expansion or special need is under consideration, we recommend you reach out to expert resources for counsel.

A/V Consultant

The A/V equivalent of an architect. When new construction or full renovation of a building space is proposed, an A/V consultant is often used to translate customer requirements into a job specification.

A/V Integrator/Installer

These are the people who install A/V systems, either working from a consultant's specifications or working directly with the customer (called a "design/build" project). Integration companies come in all sizes, may be regional or local, and may specialize in a particular type of installation (commercial office, restaurant venue, house of worship, etc.). Many are outstanding resources for both staff training and technical support.

Manufacturers

The makers of audio gear tend to be a pretty fanatical lot, and most of them support their own products directly and expertly, often modeled after high-tech firms, with online knowledge bases, user community forums, training seminars, and phone support. Shure is an audio industry leader in customer support.

Industry Organizations

The audio-video industry offers knowledge, training and certification to its members through several organizations. InfoComm (www.infocomm.com) and the National Systems Contractor Association (www.NSCA.org) are the industry's leading trade organizations. Both are a great source of knowledge for integration professionals and end users alike. Synergetic Audio Concepts (www.prosoundtraining.com) is an independent audio education resource, offering expert audio training via both in-person and online paths.

Shure Resources

Shure considers outstanding customer support to be a key part of our business model. We urge you to explore the Shure Support section of our website. (link: <http://www.shure.com/americas/support>), where you'll find contact info and instructions for service and repairs, along with a wealth of valuable audio resources:

Product Support – Shure is one of the few companies in pro audio that maintains a brand-neutral group of audio experts on staff. Our Applications Engineering Group has one specific purpose: to help our users, whether it involves the use of Shure products or is more general in nature. This is a two-stage resource of amazing depth and accuracy.

- **Shure Knowledge Base** – This is an online resource containing the answers to virtually every audio question asked and answered by Shure over the years. The database is fully searchable, to the point where typing in your question has a very high likelihood of connecting directly to the needed answer. Set your browser to bookmark <http://shure.custhelp.com/app/answers/list>.
- **Shure Systems Support** – Their primary purpose is to help end users, facility managers, AV consultants and installers to properly select and deploy Shure solutions to virtually any audio problem. Contact them at systemssupport@shure.com.

Wireless Tools – Because the RF landscape is constantly changing, Shure maintains a regularly updated web presence with frequency information, selection guides, and a range of related resources for use with Shure wireless systems. (link: <http://www.shure.com/americas/support/tools>)

Shure Educational Publications – Visit our Publications pages to explore a wide range of downloadable books and guides covering a wide range of audio products and applications. (link: <http://www.shure.com/americas/support/downloads/publications>)

Shure Webinars – Shure Systems Support Group offers regularly scheduled webinars providing in-depth training on the Shure product line and other audio-related topics. (link: <http://www.shure.com/americas/support/training>)

Shure YouTube Channel – Our YouTube channel offers a wide range of helpful videos explaining specific products, their features, and how to use them. (link: <https://www.youtube.com/user/shureinc>)

Shure Blog – Our blog presence combines education, news, musical artists, and events. This eclectic and constantly growing library of content includes webinars, event coverage, interviews, and the latest product news. (link: <http://blog.shure.com/>)

Customer Forums – Shure forums allow product users and Shure experts to post questions, share expertise, and find solutions. (link: <http://shure-community.custhelp.com/pages/home>)

Audio Systems Guide for MEETINGS AND CONFERENCES

Product Selection Chart

Model	Description	Comment
WIRED MICROPHONES		
<i>Centraverse™ microphones offer affordable audio for installed applications requiring plug-and-play solutions.</i>		
CVB-B/C	Cardioid, low-profile boundary condenser microphone	
CVB-B/O	Omnidirectional, low-profile boundary condenser microphone	
CVG12-B/C	Cardioid dual-section gooseneck condenser microphone with attached preamplifier (12 inch)	Can be attached to CVD-B Desktop Base if mic will be moved
CVG18-B/C	Cardioid dual-section gooseneck condenser microphone with attached preamplifier (18 inch)	
CVO-B/C	Cardioid overhead condenser microphone (black)	
CVO-W/C	Cardioid overhead condenser microphone (white)	
<i>Microflex® microphones feature interchangeable cardioid, supercardioid, and omnidirectional condenser cartridges that tailor the mics to the needs of the space.</i>		
MX391	Miniature boundary condenser microphone w/inline preamp (black)	Available with cardioid (C), supercardioid (S), omnidirectional (O) pattern
MX391W	Miniature boundary condenser microphone w/inline preamp (white)	
MX392	Boundary condenser microphone w/built-in preamp (black), programmable switch and LED indicator, attached unterminated cable, logic functions	
MX393	Boundary condenser microphone w/built-in preamp (black), programmable switch and LED indicator, removable XLR cable	
MX395	Low-profile boundary 'button' condenser microphone for through-table mounting	
MX396/C-DUAL	Boundary microphone with 2 cardioid condenser elements	Requires 2 inputs on mixer
MX396/C-TRI	Boundary microphone with 3 cardioid condenser elements	Requires 2 inputs on mixer
MX405	5 inch shock-mounted gooseneck condenser microphone with green LED light ring at base	Available with cardioid or supercardioid pattern.
MX405R/N	5 inch shock-mounted gooseneck condenser microphone with red LED light ring at top; cartridge not included	
MX410	10 inch shock-mounted gooseneck condenser microphone	
MX410R/N	10 inch shock-mounted gooseneck condenser microphone with red LED light ring at top; cartridge not included	
MX415	15 inch shock-mounted gooseneck condenser microphone with green LED light ring at base	
MX415R/N	15 inch shock-mounted gooseneck condenser microphone with red LED light ring at top; cartridge not included	Available less preamp (LP) for use with MX400DP desktop base if mic will be moved.
MX412	12 inch gooseneck condenser microphone with attached preamp	Available with cardioid or supercardioid pattern.
MX418	18 inch gooseneck condenser microphone with attached preamp	Available with or without on/off switch and LED indicator.
MX412D	12 inch gooseneck condenser microphone on desktop base with programmable switch and LED	Available with cardioid or supercardioid pattern.
MX418D	18 inch gooseneck condenser microphone on desktop base with programmable switch and LED	
MX202	Mini-condenser microphone for overhead miking	Available in black or white Available with cardioid or supercardioid pattern Available with in-line preamp or wall-plate preamp

Product Selection Chart

Model	Description	Comment
WIRELESS SYSTEMS		
BLX® Series	Affordable UHF wireless system with simple setup and QuickScan frequency selection	Handheld and bodypack systems available with lavalier or headworn microphones. Rack-mount receivers feature removable antennas for remote mounting outside of the room.
QLX-D™ Series	Digital wireless system with networked control, AES-256 encryption, and smart rechargeable battery options	
ULX-D® Series	Digital wireless system with Dante™ digital audio, networked control, AES-256 encryption, smart rechargeable battery options, and High Density mode for reduced spectrum usage.	
MXW Series	Digital wireless microphone solution designed for enterprises. Handheld, bodypack, boundary, and gooseneck transmitters mate with wireless access point and recharge in networked docking station. Dante™ digital audio, AES-256 encryption, network control via browser-based GUI.	
LAVALIER & HEADWORN MICS FOR WIRELESS SYSTEMS		
MX150B/O-TQG	Omnidirectional subminiature lavalier condenser microphone	
MX150B/C-TQG	Cardioid subminiature lavalier condenser microphone	
MX153B/O MX153T/O MX153C/O	Omnidirectional earset headworn microphone (black, tan, cocoa)	Extremely light weight and minimal visibility is ideal for presenters
WL183	Microflex omnidirectional lavalier microphone	
WL184	Microflex supercardioid lavalier microphone	
WL185	Microflex cardioid lavalier microphone	
MIXERS & PROCESSORS		
SCM268	4-channel microphone mixer with 4 XLR inputs and 1 aux input; phantom power for condenser microphones	
SCM410	4-channel automatic mixer with IntelliMix, phantom power, XLR inputs and output	
SCM800	8-channel microphone mixer with screw-terminal block connector inputs, phantom power, headphone jack	RKC800 accessory converts block input connectors to 8 XLR input connectors for easier setup
SCM810	8-channel automatic mixer with IntelliMix, phantom power, headphone jack	
SCM820	8-channel automatic mixer with Digital IntelliMix, phantom power, 2 channels of Digital Feedback Reduction, browser-based GUI, optional Dante digital audio networking	Available with block connectors or DB25 connectors
DFR22	2-input, 2-output digital audio processor with Digital Feedback Reduction, EQ, dynamics processing, matrix mixer and browser-based GUI	
DISCUSSION & CONFERENCE SYSTEMS		
DDS 5900	Digital Discussion System for meetings with up to 250 participants; supports 2 interpretation languages	Available with portable or flush-mount discussion units
DCS 6000	Digital Conference System for meetings with up to 3,800 participants; supports 31 interpretation languages. Optional SW 6000 software enables comprehensive meeting management, including agenda, voting, seat assignments, delegate ID, etc.	Available with portable, flush-mount, or modular conference units to suit room/table requirements

Crispin Tapia

Crispin Tapia is a Systems Support Engineer at Shure Incorporated. He has been active in the Chicago music scene for many years as a performer, and has experience in live sound engineering and studio recording. He has earned both a Bachelor's Degree in Psychology from the University of Illinois at Chicago, and a Bachelor's Degree in Audio Engineering from Columbia College Chicago. His responsibilities at Shure Incorporated include providing technical support via phone, email, web forums, live chats, etc., and conducting product training seminars to Shure dealers, Shure staff, and end users. Since joining Shure in 1996, Crispin has authored several educational booklets, numerous FAQ's, and has presented on technical audio topics for professional trade organizations such as NAMM, WFX, and the GRAMMY® Foundation.

Chris Lyons

Chris Lyons is Senior Manager, Conferencing Market Communications at Shure Incorporated. In his 30 years at Shure, he has served in a variety of positions in marketing, product management, technical support, and public relations. He has written, co-written, or edited a number of educational booklets and feature articles for industry trade publications. He also provides voiceovers for many Shure educational videos.

Additional Shure Publications Available:

Printed and electronic versions of the following guides are available free of charge. To obtain your complimentary copies, call one of the phone numbers listed below or visit www.shure.com.

- Audio Systems for Video Production
- Selection and Operation of Wireless Systems
- Microphone Techniques for Live Sound Reinforcement

Our Dedication to Quality Products

Shure offers a complete line of microphones and wireless microphone systems for everyone from first-time users to professionals in the music industry—for nearly every possible application.

For over nine decades, the Shure name has been synonymous with quality audio.

All Shure products are designed to provide consistent, high-quality performance under the most extreme real-life operating conditions.

SHURE[®]
LEGENDARY
PERFORMANCE™

**United States, Canada,
Latin America, Caribbean:**
Shure Incorporated
5800 West Touhy Avenue
Niles, IL 60714-4608 USA

Phone: +1 847-600-2000
Fax: +1 847-600-1212 (USA)
Fax: +1 847-600-6446
Email: info@shure.com
www.shure.com

©2016 Shure Incorporated

Europe, Middle East, Africa:
Shure Europe GmbH
Jakob-Dieffenbacher-Str. 12,
75031 Eppingen, Germany

Phone: +49-7262-92490
Fax: +49-7262-9249114
Email: info@shure.de
www.shure.eu

AL29172 2.5M 6/16

Asia, Pacific:
Shure Asia Limited
22/F, 625 King's Road
North Point, Island East
Hong Kong

Phone: +852-2893-4290
Fax: +852-2893-4055
Email: info@shure.com.hk
www.shureasia.com