



User Manual

NPS-30W
Gigabit PoE Supply



NEUTRIK®

Imprint

Subject to change due to advances in technology! This user manual corresponds to the level of technology at the time the product was delivered and not the current stage of development at Neutrik.

If any pages or sections of this user manual are missing, please contact the manufacturer at the address listed below.

Copyright

This user manual is protected by copyright. The user manual must not be duplicated, reproduced, microfilmed or translated, nor must it be converted to be saved and processed in IT systems, neither in the form of excerpts nor in full, without the express written authorization of Neutrik.

Copyright by: © Neutrik® AG

Document Identification

Document No: BDA 579

Version: 2020/09 V2

Language: English

Original language: English

Each user manual in a different language is a translation of the operating manual in English.

Manufacturer

Neutrik® AG

Im alten Riet 143

9494 Schaan

Liechtenstein

Phone: +423 2372424

Fax: +423 2325393

E: neutrik@neutrik.com

www.neutrik.com



Table of Contents

1 About this Document	4
1.1 Significance of the user manual	4
1.2 Designations	4
1.3 Explanation of symbols	5
1.3.1 Symbols in illustrations	5
1.4 Target group	5
2 Safety	6
2.1 Warning information and signal words	6
2.2 Warning symbols	6
2.3 Important regulatory notes	6
2.3.1 Declaration of conformity	7
2.4 Important safety instructions.....	7
2.5 Intended use.....	7
2.6 Foreseeable improper use	7
3 Components and Accessories	8
4 Description of the Product	9
4.1 What is the Gigabit PoE Supply?	9
4.2 Device	9
4.3 Connections and displays.....	9
4.3.1 Overview front.....	9
4.3.2 Overview rear	10
5 Operation	11
5.1 Preparations.....	11
5.2 Connecting devices with the Gigabit PoE Supply	11
5.3 Applications.....	13
5.3.1 Power and Data Redundancy	13
5.3.2 Daisy-chaining	13
5.4 Accessories assembly instructions.....	14
5.4.1 Mounting brackets NA-MB-KIT	15
5.4.2 Rack panel NRP1RU-2A.....	16
5.5 Trussmount for Neutrik Network Devices NA-TM-KIT.....	17
6 After Operation	18
6.1 Dismounting devices	18
6.2 Transporting	18
6.3 Storage.....	18
6.4 Cleaning and care	18
6.5 Maintenance and repair	18
6.6 Disposal.....	19
7 Appendix	20
7.1 Technical specifications.....	20
7.2 PoE (Power over Ethernet)	20
7.2.1 Definitions.....	20
7.2.2 PoE Standards	21
7.2.3 Classes and discovery process.....	21



1 About this Document

This user manual provides an overview of the necessary operation steps and settings on the product.

1.1 Significance of the user manual

i This user manual is an integral component of the product and part of the product's safety concept.

- ▶ Make sure that all persons who work with the product have fully read and also understood this user manual.
- ▶ Observe all instructions exactly, especially the safety instructions.

i This user manual contains important information on safely and properly operating the product.

- ▶ Keep this user manual in the immediate vicinity of the product so personnel have access to it at all times.

- ▶ Pass this user manual on to every user, e.g., by lending it, or to the future owner of the product.
- ▶ If this user manual is lost or damaged, a copy of it can be downloaded from the Neutrik's website (www.neutrik.com).

1.2 Designations

Designation	Explanation
Gigabit PoE Supply	Gigabit PoE Supply NPS-30W; to ensure the text is easy-to-read, the device is hereinafter referred to as Gigabit PoE Supply.
Dante™ audio networking	Dante™ audio networking (hereinafter referred to as Dante™) Dante™ stands for D igital A udio N etwork T hrough E thernet and is an audio network protocol developed by the Australian company Audinate. Dante™ delivers uncompressed, multi-channel, low-latency digital audio over a standard Ethernet network using Layer 3 IP packets.
PoE	Power over Ethernet; the device is supplied with power via the network connection.
Peripheral devices	Any device that uses PoE as a power source.
Audio source	Any device that emit an audio signal
Audio sink	Any device that receives audio signals, such as loudspeakers, audio systems (amplifiers, mixing consoles, etc.)

1.3 Explanation of symbols

Uniform safety instructions, symbols, terms and abbreviations were used to make this user manual easier to understand. The following symbols designate instructions that are not relevant to safety, but make the operating manual easier to understand.

- ✔ The preconditions for an action are depicted with this symbol. Complete the items as listed before carrying out the action steps that follow.
- ▶ Action steps are designated by this symbol. Carry out the action steps in the order they are presented.
- ✔ The result of the action or the reaction of the product to the action are depicted with this symbol.
 - Lists without a mandatory sequence are presented as a list with this bullet.
 - 1. Numbered listings are displayed in this manner.
 - (1) Refers to a position in an illustration.



Wherever you see this symbol, you will find useful information for safe, trouble-free operation of the product.

1.3.1 Symbols in illustrations

Symbol	Explanation
	Image position
	Action steps numbered in an illustration. Carry out the action steps in the order they are presented.

1.4 Target group

This user manual is intended for sound engineers, musicians and personnel who have comprehensive experience in sound and event technology.

2 Safety

2.1 Warning information and signal words

Special warning information regarding potential dangers inherent in a particular action are presented before instructions for an action. The warnings are ranked as follows:

⚠ CAUTION

Potential risk of danger!

This type of warning points out a situation that could result in minor or moderate injuries.

- ▶ Minor injuries may result if this warning is ignored.

⚠ NOTE

Potential risk of property damage!

This type of warning points out a situation that could result in damage to the device and its components.

- ▶ Property damage may result if the warning is ignored.

2.2 Warning symbols

Symbol	Warning
	General warning

2.3 Important regulatory notes

This equipment has been tested and found to comply with the limits for a Class B digital device, pursuant to Part 15 of the FCC Rules. These limits are designed to provide reasonable protection against harmful interference in a residential installation. This equipment generates, uses and may radiate radio frequency energy and, if not installed and used in accordance with the instructions, may cause harmful interference to radio communications. However, there is no guarantee that interference will not occur in a particular installation. If this equipment does cause harmful interference to radio or television reception, which can be determined by turning the equipment off and on, the user is encouraged to try to correct the interference by attempting one or more of the following measures:

- Reposition or relocate the receiving antenna.
- Increase the distance between the equipment and receiver.
- Connect the equipment to an outlet on a circuit different from to the one that the receiver is connected to.
- Consult the dealer or an experienced radio/TV technician for help.

⚠ NOTE

Changes or modifications made to this equipment not expressly approved by Neutrik may void the FCC authorization to operate this equipment.

2.3.1 Declaration of conformity

The device meets all the relevant EU directives and therefore has the CE and EAC marking. The Declaration of Conformity may be viewed at <https://www.neutrik.com/en/support/downloads>.

2.4 Important safety instructions

Avoid property damage to the Gigabit PoE Supply due to unsuitable operating and environmental conditions:

- Never immerse in water.
- Protect from strong sunlight.
- Never install the device near heat sources such as radiators, heating units, ovens or stoves.
- To avoid overheating, never cover the device.
- Protect the device from impact and above all, from falling from poles, stages, tables or furniture.

Repair

NOTE

Property damage due to improper repair!

The Gigabit PoE Supply does not contain any parts that you can repair yourself. Opening or repairing the device on your own may result in severe damage to the device.

- ▶ Do not open the housing of the Gigabit PoE Supply under any circumstances.
- ▶ Do not change any parts yourself.
- ▶ Only have the Gigabit PoE Supply repaired by a authorized specialist dealer.

Information for operation

- ▶ Ensure that the ambient conditions specified for the Gigabit PoE Supply is observed during operation.
- ▶ Do not use the Gigabit PoE Supply if it is not functioning properly, has fallen or been damaged, has become wet or if parts of it have been immersed in water.
- ▶ If disruptions occur during operation:
Immediately disconnect the Gigabit PoE Supply from main.
- ▶ Do not operate the Gigabit PoE Supply in environments where flammable or explosive materials, gases or vapors are present or might occur.

2.5 Intended use

The Gigabit PoE Supply is a Gigabit power supply used to supply power and transmit data over Ethernet

2.6 Foreseeable improper use

The Gigabit PoE Supply is not suitable for use outdoors and in potentially explosive atmospheres.

3 Components and Accessories

The device and the accessories can be ordered separately.



Pos.	Description	Item no.
1	Gigabit PoE Supply NPS-30W	NPS-30W
2	Mounting brackets (Kit includes 2 brackets, 2 fixing screws, 2 torx screws and 2 spacers)	NA-MB-KIT
3	Rack panel	NRP1RU-2A
4	Removable rubber protection	NA-RC
5	Trussmount kit (Kit includes 4 cross screws, 4 fixing screws, 2 safety frames, 1 yoke mount)	NA-TM-KIT

4 Description of the Product

4.1 What is the Gigabit PoE Supply?

The Gigabit PoE Supply is a Gigabit power supply intended to provide power to devices over ethernet. It is a passive power supply, meaning that power-negotiation is not supported and power is delivered at all times. More information please find in chapter "7.1 Technical specifications" on page 20.

The Gigabit PoE Supply is designed for harsh stage conditions and offers a reliable solution for powering various devices. With optional accessoires, it offers several mounting options including truss mount, rack mount and table/wallbox mount to fit the needs of system integrators and live entertainment engineers.

4.2 Device



Pos.	Description
1	Sheet metal housing
2	Rubber protection (removable)

4.3 Connections and displays

4.3.1 Overview front

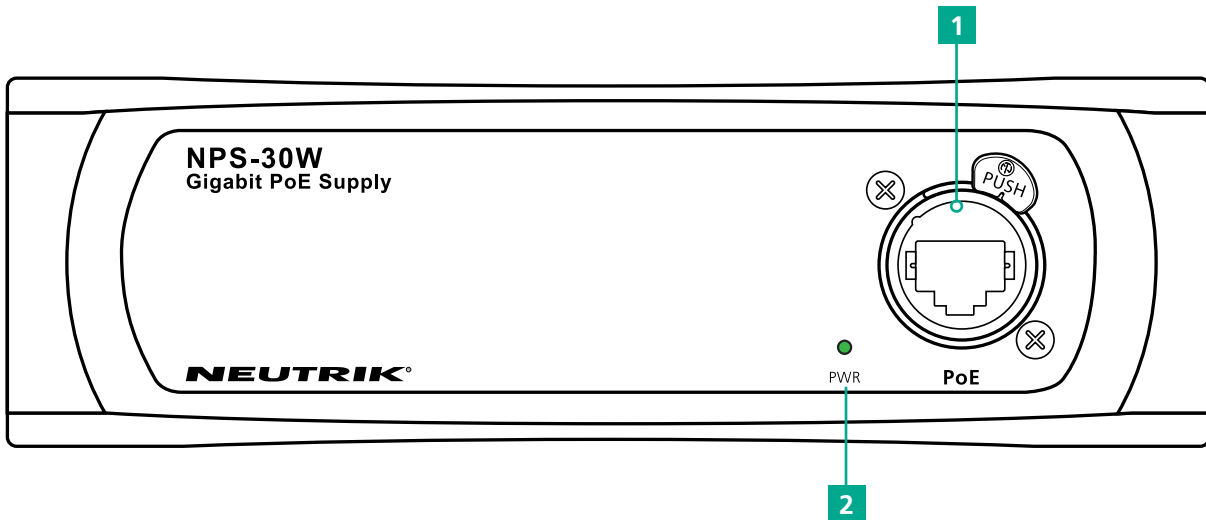

Pos.	Description
1	PoE and Data out connection (RJ45) Delivers power over ethernet (PoE) and data in 1 Gbps speed.
2	Power LED Indicates that the unit is powered <ul style="list-style-type: none">• LED lights up green: Unit is powered.• LED off: Power off.

4.3.2 Overview rear

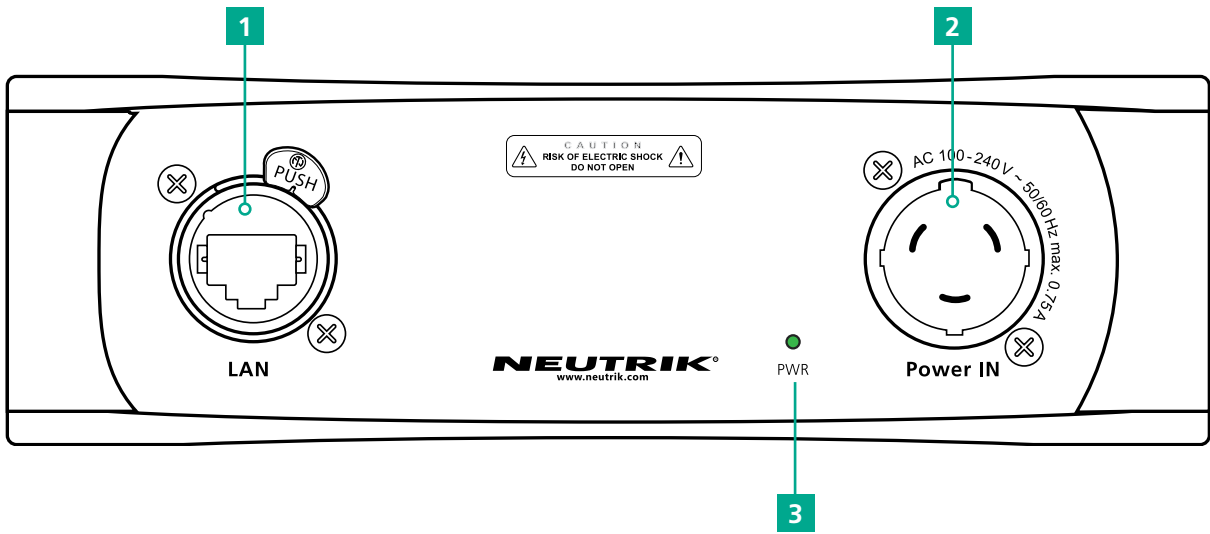

Pos.	Description
1	Data in connection (RJ45) Used for the unpowered data transmission between Gigabit PoE Supply and a network device.
2	Power in connection (PowerCON TRUE1) AC 100-240 V - 50 - 60 Hz, max. 0,75 A power connection.

Pos.	Description
3	Power LED Indicates that the unit is powered <ul style="list-style-type: none"> • LED lights up green: Unit is powered. • LED off: Power off.

5 Operation

5.1 Preparations

- ▶ Unpacking the Gigabit PoE Supply.
- ▶ Save packaging for later transport and storage.
- ▶ Check the packaging and the Gigabit PoE Supply for visible damage.
- ▶ When visible damage to the packaging and/or delivered parts is detected:
Contact the salesperson or Neutrik sales partner.
- ▶ Do not use damaged devices under any circumstances.

5.2 Connecting devices with the Gigabit PoE Supply

The Gigabit PoE Supply is installed as a midspan device between the PoE powered device and a Ethernet device without power output.

- For a load of 20 W or higher, it is mandatory to use AWG24 or higher cross-section cables.
- For cable lengths of 50 m or longer, it is mandatory to use AWG24 or higher cross-section cables.
- F / UTP Kat 6A cables are recommended.
(F / UTP cables can better dissipate heat due to the screen)

NOTE

Risk of device damage!

- ▶ Do not combine NPS-30W Gigabit PoE Supply with other PoE Supplies, as this can cause a damage to the powered device due to different pin assignment.
 - ▶ When using 2 NPS-30W PoE Supplies, do not use cables with different connection standards (TIA568A vs TIA568B). Never use Ethernet Cross-cables within PoE connections.
-
- ▶ Connect the devices depending on the desired application.
 - ▶ Connect the Gigabit PoE Supply with the power supply.
 - ✓ LEDs light up once the Gigabit PoE Supply is supplied with power.
 - ✓ The Gigabit PoE Supply is ready for operation.

Front

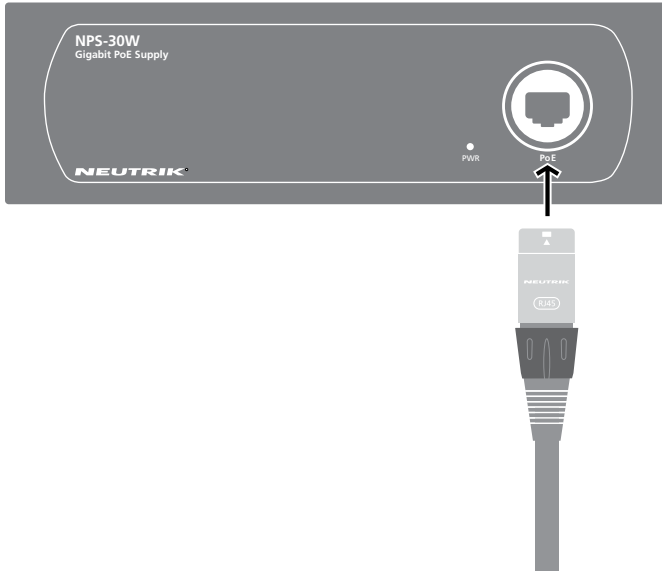

Rear

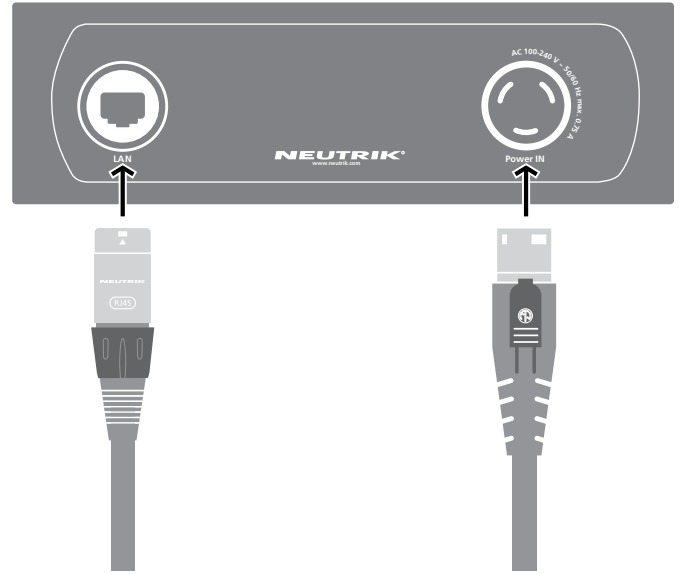

5.3 Applications

NOTE

Risk of device damage!

- ▶ Do not combine NPS-30W Gigabit PoE Supply with other PoE Supplies, as this can cause a damage due to different pin assignment.

5.3.1 Power and Data Redundancy

Example using NA2-IO-DPRO

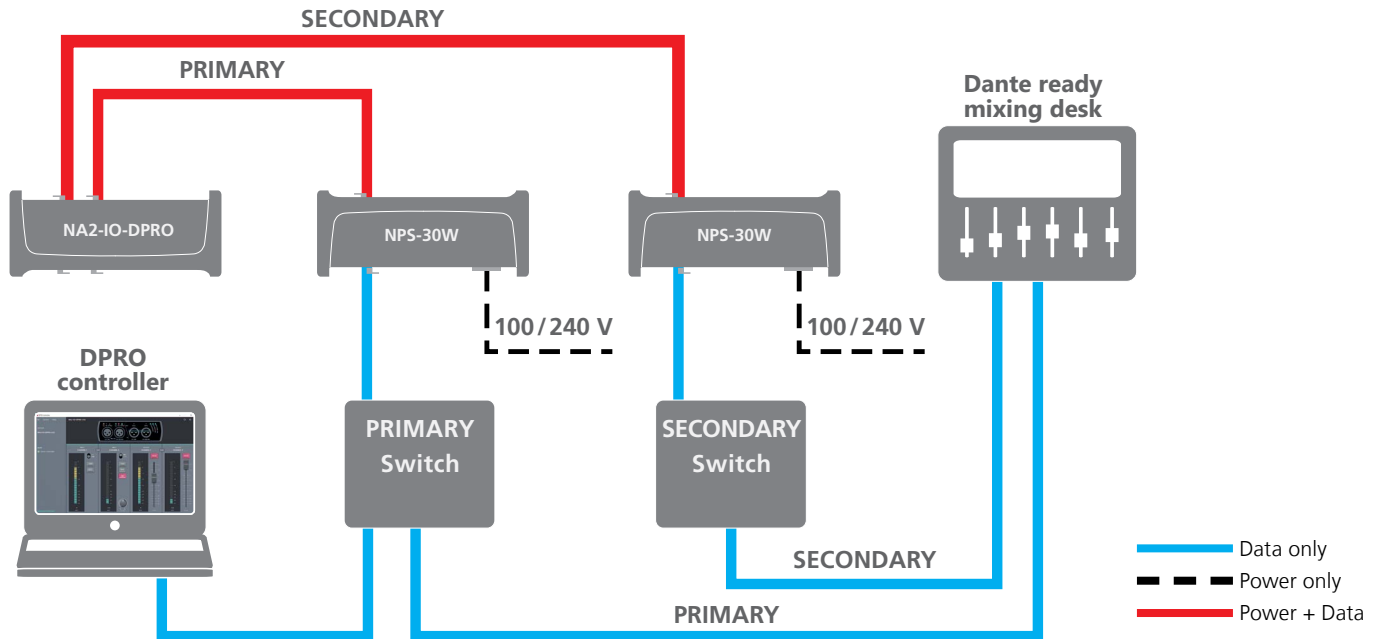

i For Power and Data Redundancy, 2 NPS-30W PoE Supplies are required.

5.3.2 Daisy-chaining

Example using NA2-IO-DPRO and NA2-IO-DLINE

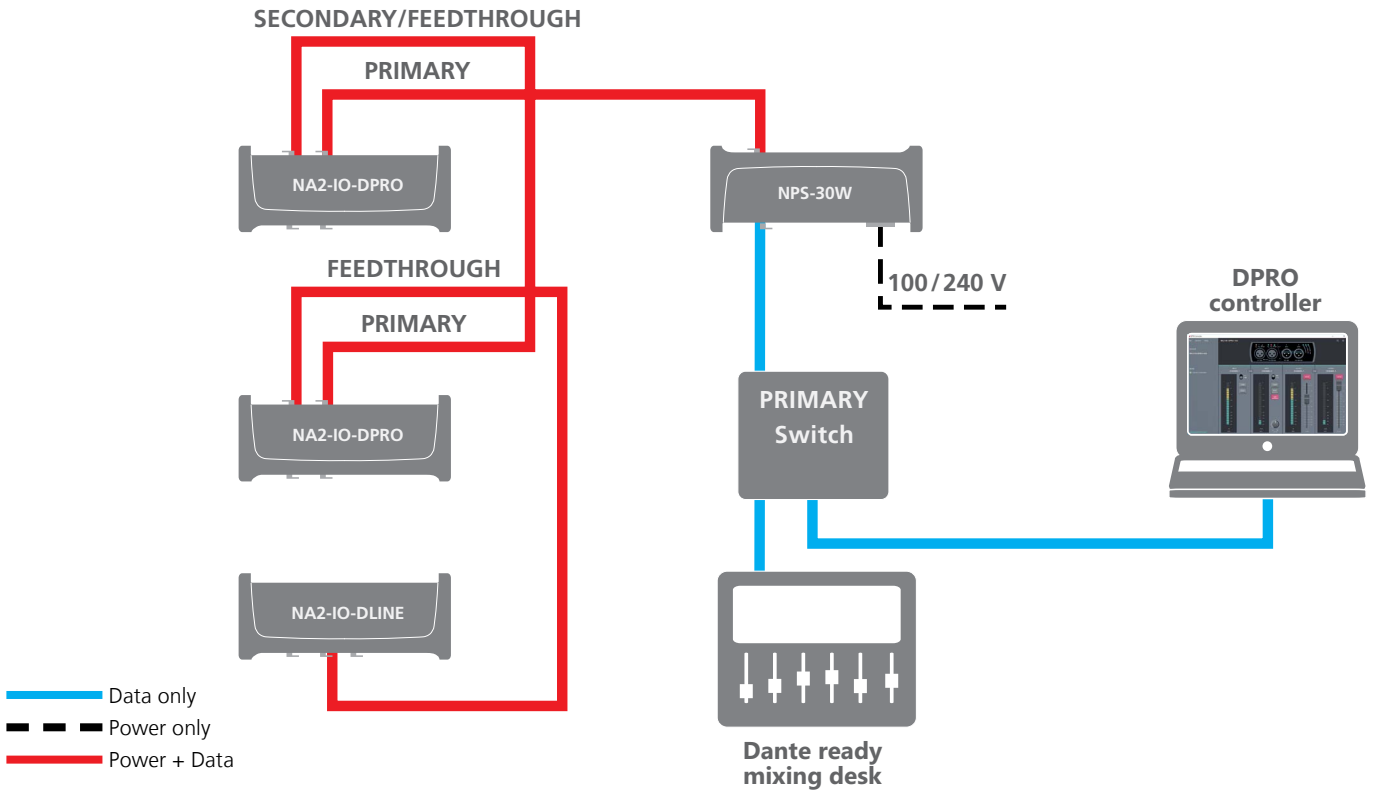

i Up to 4 NA2-IO-DPRO can be daisy chained with one NPS-30W.

5.4 Accessories assembly instructions

NOTE

Use only original Neutrik screws to prevent damage to the device.

5.4.1 Mounting brackets NA-MB-KIT



2 brackets



2 fixing screws



2 torx screws



2 spacers

The mounting brackets make it possible to mount the device in floor boxes, underneath

1



► Remove the rubber protection.

2



► Mount a bracket, a spacer and a screw on the device as shown on the picture.
 ► Tighten the screw with the screwdriver.
 ► Repeat these steps on the opposite side of the device.

3



► Mount the fixing screw as shown on the picture.
 ► Repeat these steps on the opposite side of the device.

4



► Turn the brackets as required for the mounting situation.
 ► Tighten the fixing screw firmly.

tables, etc.

Scope of delivery



1 rack panel

Assembly of the mounting brackets

Prepare the following tools:

- ☑ Torx Screwdriver (T10)

5.4.2 Rack panel NRP1RU-2A

1



- ▶ Remove the rubber protection.

2



- ▶ Remove the 4 screws on the front of the device.

3



- ▶ Place the device in the rack panel.
- ▶ Fix the device with the four screws.



Scope of delivery Assembling the rack panel



4 cross screws



2 fixing screws



2 safety frames



1 yoke mount

Assembling the trussmount

Prepare the following tools:

- ✓ Crosshead screwdriver

1



- ▶ Remove the rubber protection.

2



- ▶ Use the existing screws (M3 x 6 mm) to install the safety frame.

3



- ▶ Place the device in the yoke mount.

4

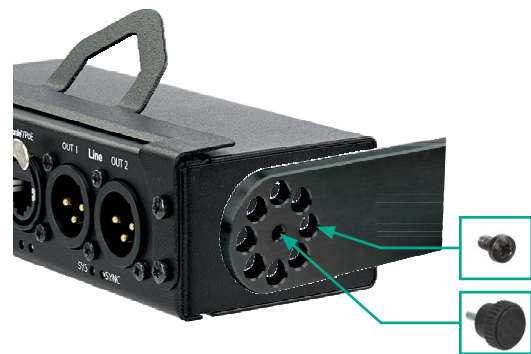

- ▶ Fix the device with the shown screws

5



Example:

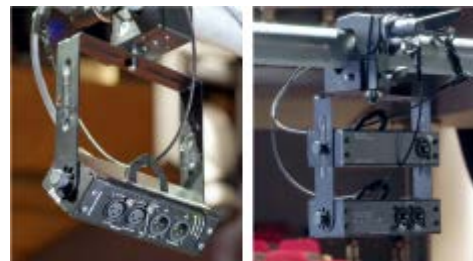

The trussmount kit can be used for up to 2 devices.

5.5 Trussmount for Neutrik Network Devices NA-TM-KIT

Scope of Delivery

6 After Operation

6.1 Dismounting devices

- ▶ Disconnect the devices.

6.2 Transporting

- ▶ Always transport devices and accessories in their original packaging.

6.3 Storage

- ▶ If devices are not used for a longer period:
Disconnect the device from the connected devices.
- ▶ Always store devices in a clean, dry location.
- ▶ Always protect devices from dirt, dust, heat, humidity and moisture.

6.4 Cleaning and care

NOTE

Danger of property damage due to improper cleaning!

- ▶ Disconnect device from all connections before cleaning.
 - ▶ Never immerse device or accessory in water under any circumstances.
 - ▶ Never spray device or accessory with liquids under any circumstances.
-
- ▶ Wipe the surfaces of the device and accessory with a soft cloth slightly moistened with a mild soap solution.
 - ▶ Never use aggressive, solvent-based or abrasive cleaning agents under any circumstances.
 - ▶ Never use rough materials (e.g., cleaning cloths or sponges with a rough coating).

6.5 Maintenance and repair

The Gigabit PoE Supply does not contain any parts that can be maintained or repaired by the user.

- ▶ Only have the Gigabit PoE Supply repaired by a specialist dealer authorized by Neutrik.
- ▶ Check the Gigabit PoE Supply regularly for visible damage to the housings, controls, connections, cables and plugs.
- ▶ If damage is detected, do not use device under any circumstances.

- ▶ Immediately decommission the damaged device.
- ▶ Replace defective cables or accessories immediately.

6.6 Disposal

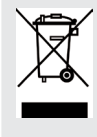

- ▶ Dispose of the Gigabit PoE Supply and accessories in accordance with the applicable local regulations.
- ▶ Never dispose of electrical devices or electrical accessories such as cables, plugs, batteries or components with household wastes under any circumstances.

- ▶ Dispose of packaging and packaging elements in accordance with the applicable local regulations.
- ▶ Take device components made of plastic, metal or other recyclables for reclamation in accordance with the applicable local regulations.

7 Appendix

7.1 Technical specifications

Electrical specifications

Input voltage range	100 – 240 VAC
Input frequency range	50 – 60 Hz
Input max. current	0.75 A
Output voltage	48 VDC
Output max. current	0.63 A
Rated Power	30 W

Mechanical specifications

Weight	0.53 kg / 1.17 lbs
Dimensions (with rubber protection)	L = 164 mm (6.4 inches) B = 82 mm (3.2 inches) H = 51 mm (2.0 inches)
Dimensions (without rubber protection)	L = 151 mm (5.9 inches) B = 66 mm (2.6 inches) H = 41 mm (1.6 inches)
Operating environment	Indoor
Operating temperature	–5°C to +50°C
Storage temperature	–40°C to +150°C

7.2 PoE (Power over Ethernet)

PoE stands for Power over Ethernet and describes a practice for using a single CAT5e (or higher) to incorporate both power and data in the single cable.

Few advantages:

- Easy setup
- Single cable run up to 100 m
- Using PoE doesn't require certified electrician as the power loads are small
- Existing network infrastructure can be used

7.2.1 Definitions

PD (Powered device) – device that is connected to PSE and thus is powered by it.

PSE (Power Sourcing Equipment) – device that provides power to PD, can be a network switch or injector.

PSE Types

In our case, we consider only following two types of PSE devices.

- PoE Switch: a switch that offers possibility to power PD. Switches use PoE classification.
- PoE Injector: typically a single port device for powering 1 PD. These exist with classification (active) or without (passive). Neutrik's NPS-30W is a passive PoE injector.

The term class refers to a maximal power output (see table below).



7.2.2 PoE Standards

These standards are part of IEEE 802.3 general standards.

802.3 af – defines PoE classes 0-3.

802.3 at – uses the same classes, but introduces class 4 as well.

802.3 bt – uses the same classes as 802.3 af and 802.3 at, but introduces class 5 to 8 as well.

7.2.3 Classes and discovery process

Discovery is a process of PSE, determining the power requirements of the PD. Once PD and PSE are connected, PSE sends out a short voltage impulse, reads the returned value and provides power accordingly. This is valid for PSE with class (also called active).

No class (passive) PSE, acts as a classic power supply, hence no discovery is implemented, and PSE supplies deliver current at all times.

Class	Standard	Power required by PoE class at the Powered Device (PD)
1	IEEE 802.3af	0.44 – 3.84 W
2		3.84 – 6.49 W
3		6.49 – 12.95 W
4	IEEE 802.3at	12.95 – 25.5 W
5	IEEE 802.3bt	25.5 – 40 W
6		40 – 51 W
7		51 – 62 W
8		62 – 73 W

Liechtenstein (Headquarters)

NEUTRIK AG, Im alten Riet 143, 9494 Schaan
T +423 237 24 24, F +423 232 53 93, neutrik@neutrik.com

Germany / Netherlands / Denmark / Austria

Neutrik Vertriebs GmbH, Felix-Wankel-Straße 1, 85221 Dachau, Germany
T +49 8131 28 08 90, neutrik@neutrik.de

Great Britain

Neutrik (UK) Ltd., Westridge Business Park, Cothey Way
Ryde, Isle of Wight PO33 1 QT
T +44 1983 811 441, sales@neutrik.co.uk

France

Neutrik France SARL, Rue du Parchamp 13, 92100 Boulogne-Billancourt
T +33 1 41 31 67 50, info@neutrik.fr

USA

Neutrik USA Inc., 4115 Taggart Creek Road, Charlotte, North Carolina,
28208
T +1 704 972 3050, info@neutrikusa.com

Japan

Neutrik Limited, Yusen-Higashinonbashi-Ekimaie Bldg., 3-7-19
Higashinonbashi, Chuo-ku, Tokyo 103
T +81 3 3663 47 33, mail@neutrik.co.jp

Hong Kong

Neutrik Hong Kong LTD., Suite 18, 7th Floor Shatin Galleria
Fotan, Shatin
T +852 2687 6055, sales@neutrik.com.hk

China

Ningbo Neutrik Trading Co., Ltd., Shiqi Street, Yinxian Road West
Fengjia Villiage, Hai Shu District, Ningbo, Zhejiang, 315153
T +86 574 88250833, sales@neutrik.com.cn

India

Neutrik India Pvt. Ltd., Level 3, Neo Vikram, New Link Road,
Above Audi Show Room, Andheri West, Mumbai, 400053
T +91 982 05 43 424, anklesaria@neutrik.com

Associated companies

Contrik AG

Steinackerstrasse 35, 8902 Urdorf, Switzerland
T +41 44 736 50 10, contrik@contrik.ch

H. Adam GmbH

Felix-Wankel-Straße 1, 85221 Dachau, Germany
T +49 08131 28 08-0, anfrage@adam-gmbh.de



www.neutrik.com

NPS-30W