



iRig Micro Amp

15W battery-powered guitar amplifier with iOS/
USB interface.

USER MANUAL

Table of Contents

Contents	2
English	3
Safety information	3
iRig Micro Amp	3
Register your iRig Micro Amp	4
1 Installation and setup	4
1.1 Stand-alone	4
1.2 Device connected	8
2 USB LED	10
2.1 Audio input meter and gain	10
2.2 Low battery	10
3 Specifications	11
Warranty	12
Support and more info	12
Regulatory	13

Safety information

CAUTION: RISK OF EXPLOSION IF BATTERY IS REPLACED BY AN INCORRECT TYPE. DISPOSE OF USED BATTERIES ACCORDING TO THE INSTRUCTIONS.

iRig Micro Amp can ONLY be used with:

- Consumer grade non-rechargeable CARBON-ZINC batteries
- ALKALINE batteries
- Consumer grade Ni-MH rechargeable batteries

iRig Micro Amp

Thank you for purchasing iRig Micro Amp.

Your package contains:

- iRig Micro Amp
- Lightning Cable
- USB cable
- 3/8" to 5/8" screw adapter
- 6xAA batteries
- Quick Start Guide
- Registration Card

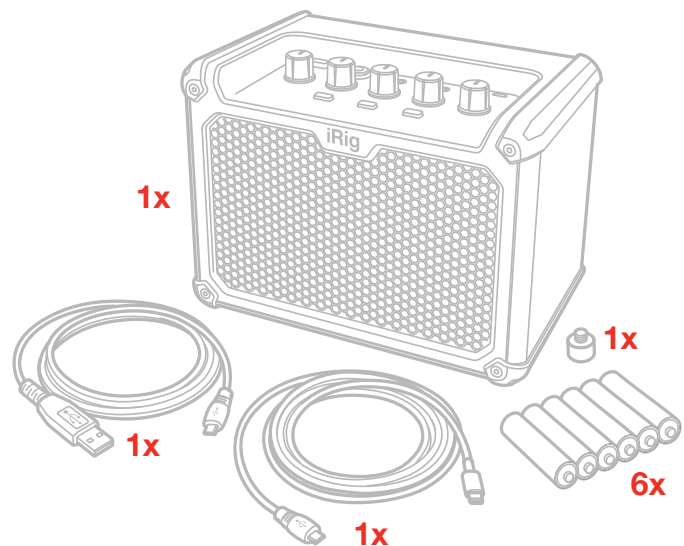

iRig Micro Amp is a compact 15W 1x4" analogue amplifier with built-in MFi audio interface that allows you to record into iOS or Mac/PC devices.

iRig Micro Amp is one of the most compact combo amplifier on the market. This makes of Micro Amp the perfect travel companion.

The compact design is achieved, also, thanks to a quality full-range 4" driver capable of 15W power.

Micro Amp can be powered either via external PSU or via 6AA batteries: this make of Micro Amp the perfect weapon for every on-the-go guitarist. The built-in Mfi audio interface, also, allows you to record your instrument directly on the connect device (iOS or Mac/PC), with a resolution up to 24bit/96kHz. Micro Amp sports 3 channels: Clean, Drive and Lead. Each channel has a set of tune controls: bass, mid and treble. Also, although it's very compact, the 15-watt Micro Amp packs a mighty punch with huge tone.

Register your iRig Micro Amp

By registering, you can access technical support, activate your warranty and receive free JamPoints™ which will be added to your account. JamPoints™ allow you to obtain discounts on future IK purchases! Registering also keeps you informed of all the latest software updates and IK products.

Register at: www.ikmultimedia.com/registration

1 Installation and setup

iRig Micro Amp can work as a stand-alone practice amp, or connected via USB to an iOS device or a MAC/ PC computer. The required power supply is guaranteed by 6xAA batteries or with the (optional) PSU. When the iRig Micro Amp is battery powered, it is capable of 7.5W RMS; when powered with the PSU its capable of 15W RMS.

1.1 Stand-alone

1. Insert the AA batteries in the battery compartment or connect the (optional) PSU.

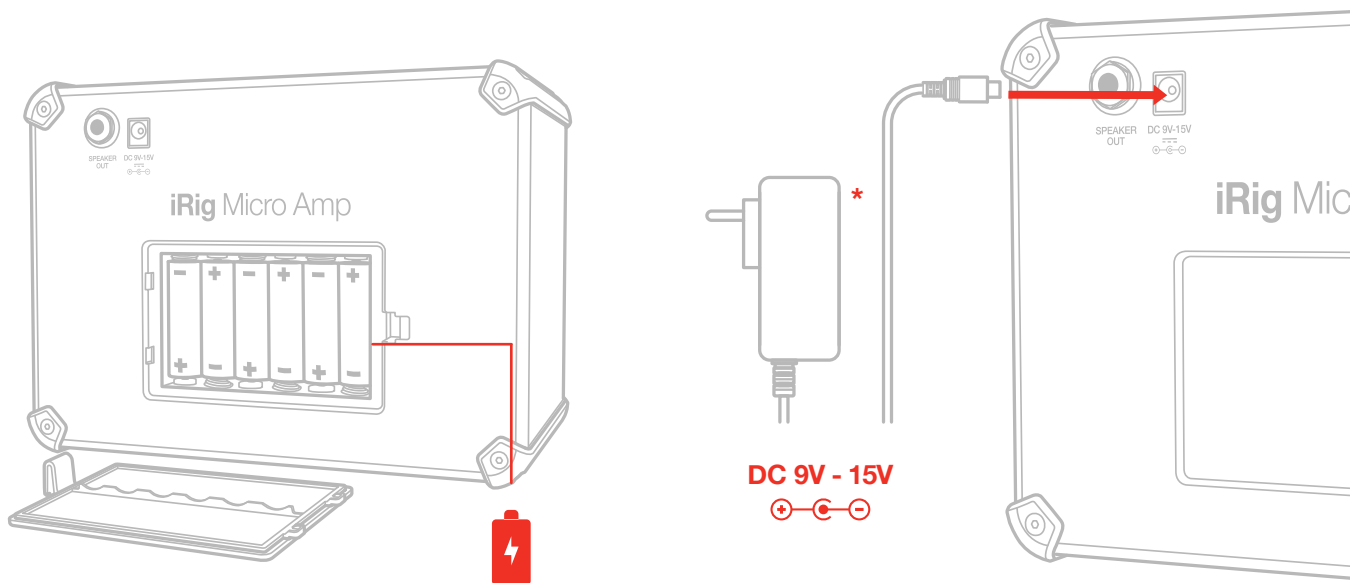

2. Turn ON the unit.

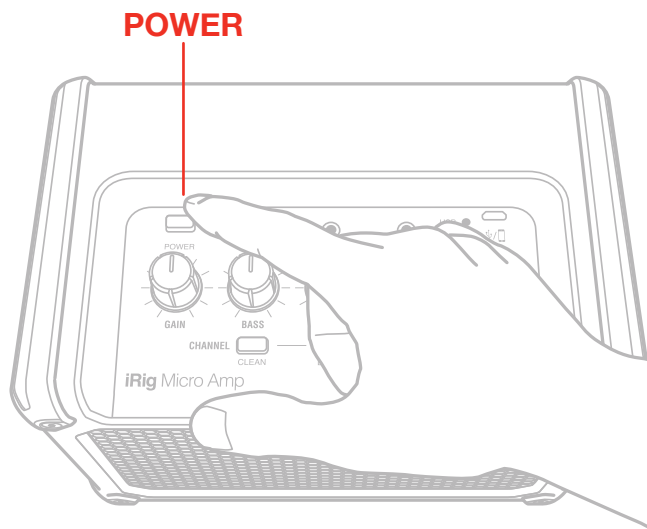

3. Connect your guitar to the instrument input of iRig Micro Amp.

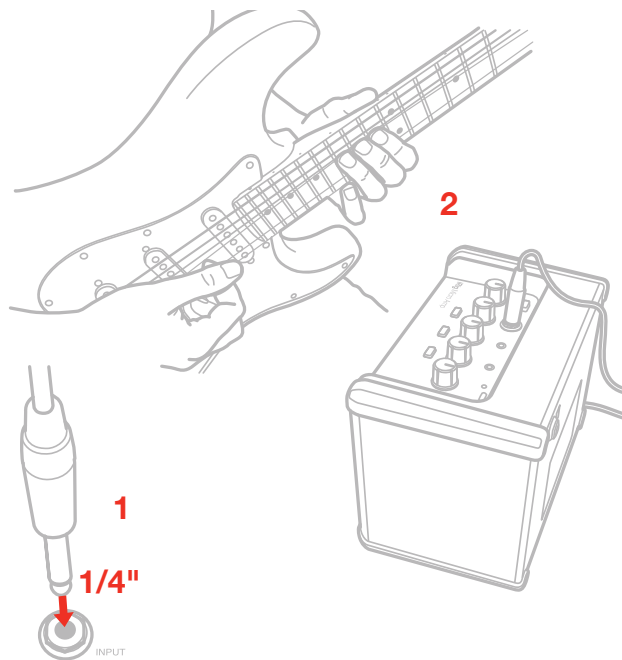

4. It is now possible to adjust your sound with the on-board tune controls for each channel. The volume potentiometer controls the speakers output volume.

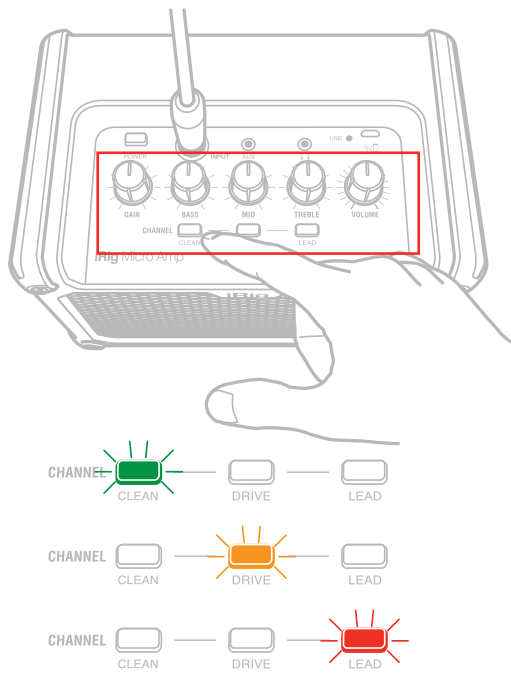

5. It is possible to connect an external sound source thru the 1/8" AUX IN, that allows you to play along your favourite songs.

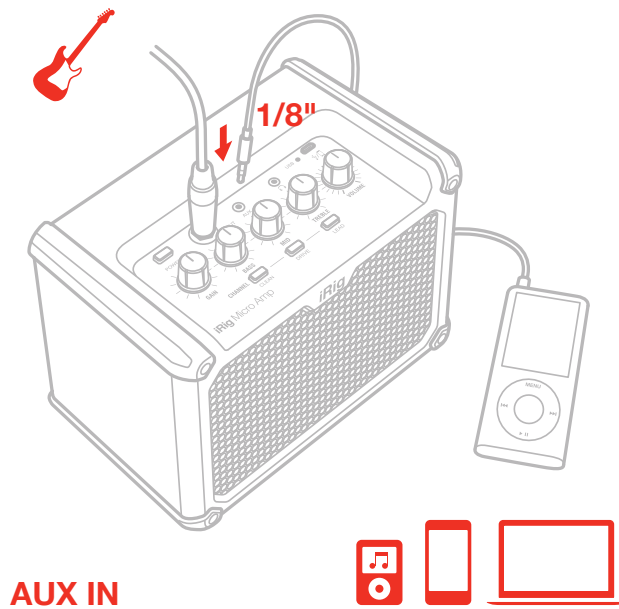

6. Connect your headphones to the headphone output. This will mute the internal speaker of iRig Micro Amp.



7. Connect an external speaker to the speaker output on the back of iRig Micro Amp. This will mute the internal speaker of iRig Micro Amp.

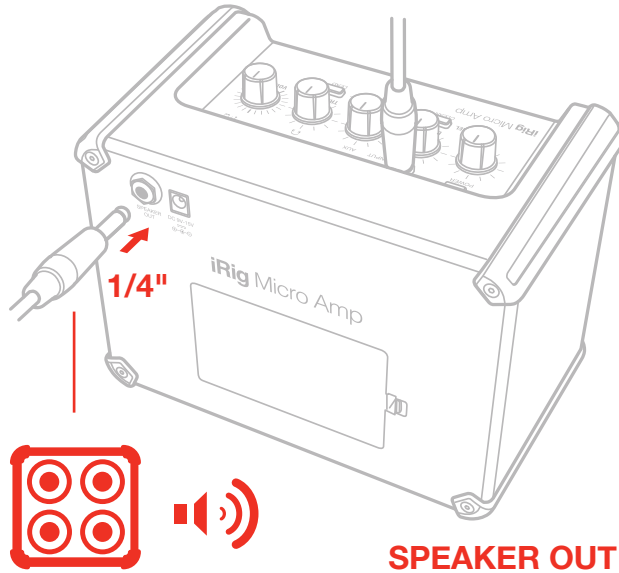

1.2 Device connected

1. Insert the AA batteries in the battery compartment or connect the (optional) PSU and turn on the unit.
2. Connect your guitar to the instrument input of iRig Micro Amp.
3. Connect the iRig Micro Amp to an iOS device or MAC/PC via the micro-USB connector. The USB LED will light up green to indicate that the USB is connected.

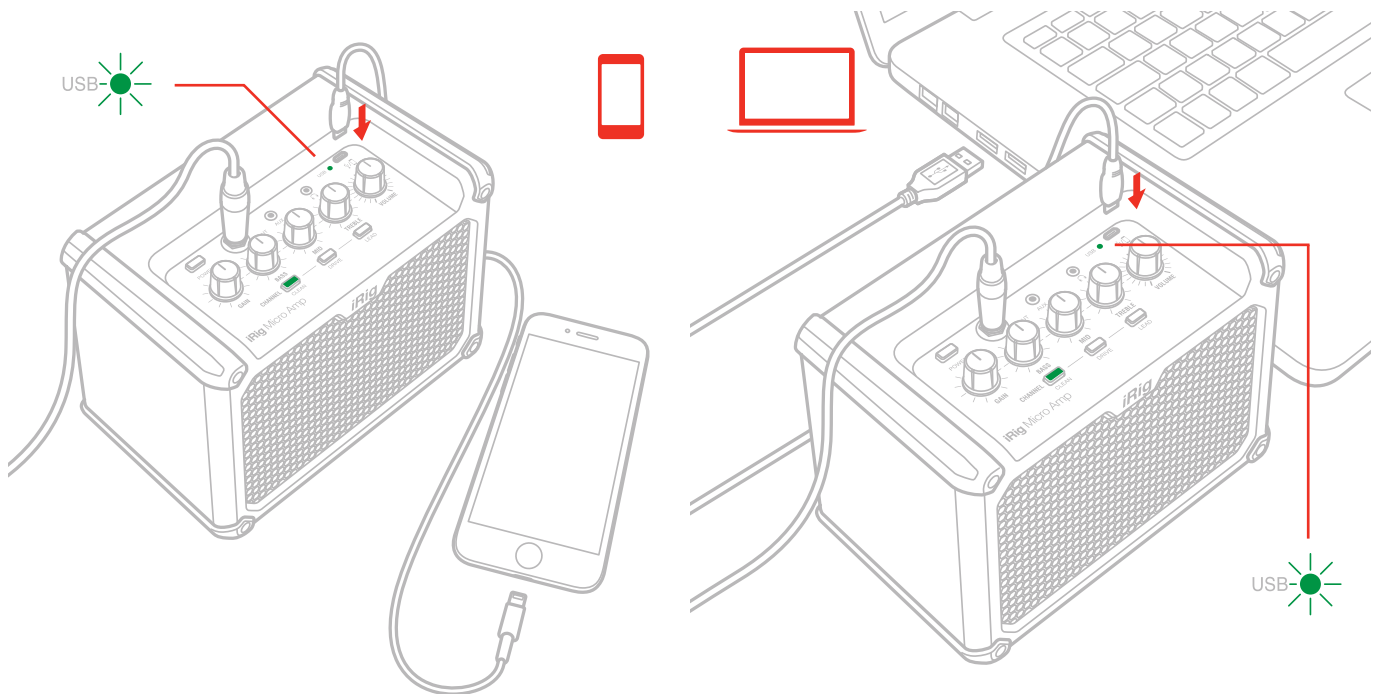

4. Download and launch the App.

**AmpliTube 4 iOS/Mac/PC
FREE DOWNLOAD**



ikdownloads.com/irigmicroamp

5. The input signal is now routed into the app, where the signal is processed, and from the app it will return to the iRig Micro Amp speaker. It is still possible to control the GAIN and VOLUME potentiometers on the control panel of iRig Micro Amp.

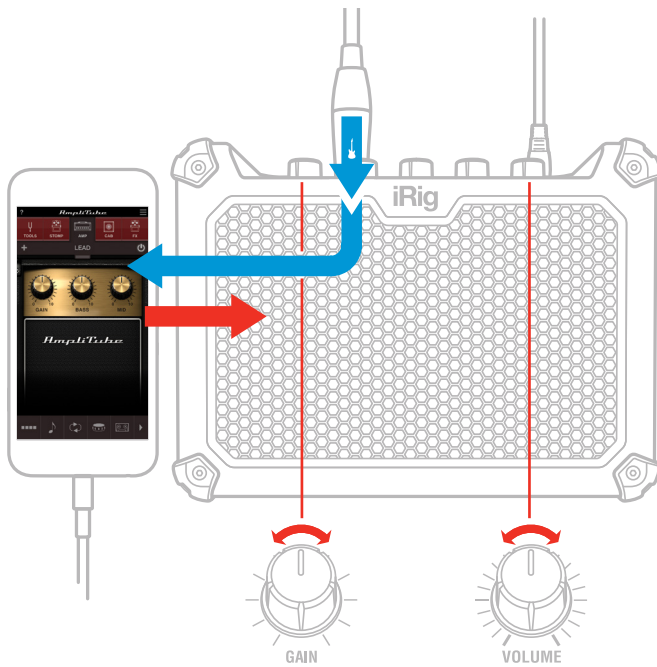

6. It is possible to connect an external sound source thru the 1/8" AUX IN, that allows you to play along your favourite songs.
7. Connect your headphones to the headphone output. This will mute the internal speaker of iRig Micro Amp.
8. Connect an external speaker to the speaker output on the back of iRig Micro Amp. This will mute the internal speaker of iRig Micro Amp.

2 USB LED

2.1 Audio input meter and gain

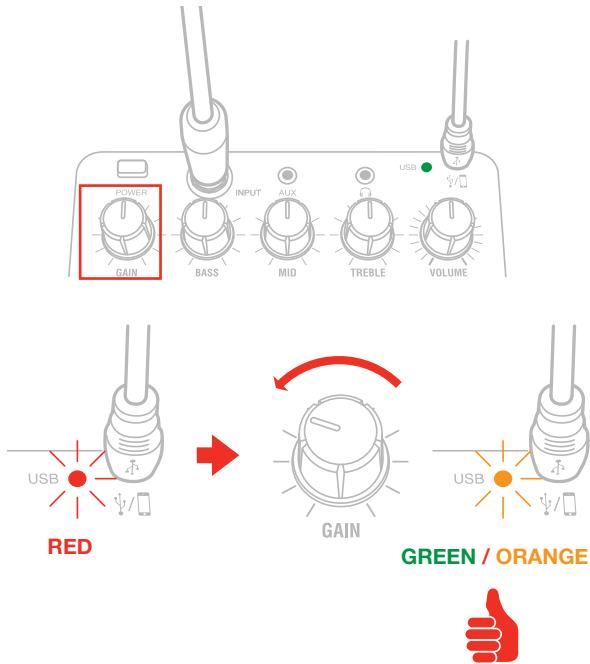

The USB LED will light up (GREEN) to indicate that a device is connected to the micro-USB port of iRig Micro Amp and acts as an audio input meter:

- LED GREEN: USB connected
- LED ORANGE: signal is present
- LED RED: clipping

2.2 Low battery

The USB LED act also as battery indicator: when the batteries level is low, the LED starts blinking orange and batteries need to be replaced as soon as possible. When the battery level is very low the LED starts blinking red.

3 Specifications

Common

Speaker: 1x4" full range (4 Ohms)

Output power: 15W (DC IN powered) or 7.5W (battery powered)

Power supply

Power: AA batteries (included) or DC IN (not included)

Battery duration: approx. 15h with 6xAA alkaline

DC IN: 9V-15V DC negative inside

USB Interface

Conversion: 24-bit A/D, 24-bit D/A

Sampling Rate: 44.1 kHz, 48 kHz, 88.2 kHz and 96 kHz

Device Connection: micro-USB

Instrument Input

Connector: unbalanced, Hi-Z, TS 1/4" Jack. Tip: signal / Shield: ground

Instrument Input Level: from 30mVpp to 6.9Vpp

Instrument Input Impedance: 1M Ω

Frequency response: 20 Hz – 20kHz +/-1.5dB

Stereo Headphone Output

Connector: 1/8" TRS Jack. Tip: right / Ring: left / Shield: ground

Dimensions and weight

Dimensions: 210mm x 125mm x 155mm

Weight: 1.26kg

Warranty

Please visit:

www.ikmultimedia.com/warranty

for the complete warranty policy.

Support and more info

www.ikmultimedia.com/support

www.irigmicroamp.com

Apple is not responsible for the operation of this device or its compliance with safety and regulatory standards.



FCC statement

This device complies with Part 15.107 and 15.109 Class B of the FCC Rules CFR47: October 2010.

Operation is subject to the following two conditions:

1. This device may not cause harmful interference.
2. This device must accept any interference received, including interference that may cause undesired operation.

Changes or modifications not expressly approved by the party responsible for compliance could void the user's authority to operate the equipment.

"Made for iPod," "Made for iPhone," and "Made for iPad" mean that an electronic accessory has been designed to connect specifically to iPod, iPhone, or iPad, respectively, and has been certified by the developer to meet Apple performance standards. Apple is not responsible for the operation of this device or its compliance with safety and regulatory standards. Please note that the use of this accessory with iPod, iPhone, or iPad may affect wireless performance.

iRig® Micro Amp, AmpliTube™ and SampleTank® are trademarks property of IK Multimedia Production Srl. All other product names and images, trademarks and artists names are the property of their respective owners, which are in no way associated or affiliated with IK Multimedia. iPad, iPhone, iPod touch Mac and Mac logo are trademarks of Apple Computer, Inc., registered in the U.S. and other countries. Lightning is a trademark of Apple Inc. App Store is a service mark of Apple Inc.