

MIPRO®

ACT-5801 1/2RU Single-Channel 5.8 GHz Receiver

ACT-5802 1/2RU Dual-Channel 5.8 GHz Receiver

ACT-5812A 1RU Dual-Channel 5.8 GHz Receiver

ACT-5814A 1RU Quad-Channel 5.8 GHz Receiver

User Guide

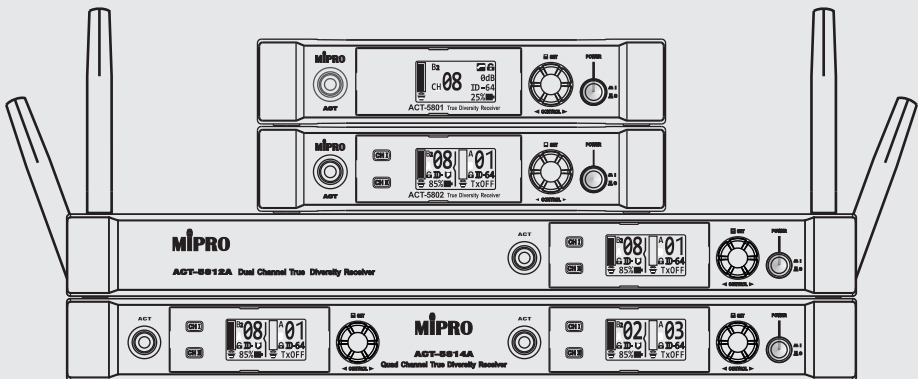

! IMPORTANT SAFETY INSTRUCTIONS !

1. Read these instructions.
2. Keep these instructions.
3. Heed all warnings.
4. Follow all instructions.
5. Do not use this apparatus near water.
6. Clean only with a dry cloth.
7. Do not block any ventilation openings. Install in accordance with the manufacturer's instructions.
8. Do not install near any heat sources such as radiators, heat registers, stoves, or other apparatus (including amplifiers) that produce heat.
9. Do not defeat the safety purpose of the polarised or ground plug: A polarised plug has two blades with one wider than the other. The wide blade is provided for your safety. When the provided plug does not fit into your outlet, consult an electrician for replacement of the obsolete outlet.
10. Protect the power cord from being walked on or pinched particularly at plug, convenience receptacles, and the point where they exit from the apparatus.
11. Only use attachments/accessories specified by the manufacturer.
12. Use only with a cart, stand, tripod, bracket, or table specified by the manufacturer, or sold with the apparatus. When a cart is used, use caution when moving the cart/apparatus combination to avoid injury from tip-over.
13. Unplug this apparatus during lightning storms or when unused for long periods of time.
14. Refer all servicing to qualified service personnel. Servicing is required when the apparatus has been damaged in any way, such as power-supply cord or plug is damaged, liquid has been spilled or objects have fallen into the apparatus, the apparatus has been exposed to rain or moisture, does not operate normally, or has been dropped.
15. To reduce the risk of fire or electric shock, do not expose this apparatus to rain or moisture.
16. Apparatus should not be exposed to dripping or splashing and no objects filled with liquids, should be placed on the apparatus.
17. Use only with the battery which specified by manufacturer.
18. The power supply cord set is to be the main disconnected device.



Federal Communication Commission Interference Statement

This equipment has been tested and found to comply with the limits for a Class B digital device, pursuant to Part 15 of the FCC Rules. These limits are designed to provide reasonable protection against harmful interference in a residential installation. This equipment generates, uses and can radiate radio frequency energy and, if not installed and used in accordance with the instructions, may cause harmful interference to radio communications. However, there is no guarantee that interference will not occur in a particular installation. If this equipment does cause harmful interference to radio or television reception, which can be determined by turning the equipment off and on, the user is encouraged to try to correct the interference by one of the following measures:

- ! Reorient or relocate the receiving antenna.
- ! Increase the separation between the equipment and receiver.
- ! Connect the equipment into an outlet on a circuit different from that to which the receiver is connected.
- ! Consult the dealer or an experienced radio/TV technician for help.

FCC Caution: To assure continued compliance, any changes or modifications not expressly approved by the party responsible for compliance could void the user's authority to operate this equipment. (Example - use only shielded interface cables when connecting to computer or peripheral devices).

FCC Radiation Exposure Statement

This equipment complies with FCC RF radiation exposure limits set forth for an uncontrolled environment. This equipment should be installed and operated with a minimum distance of 0.5 cm between the radiator and your body.

This transmitter must not be co-located or operating in conjunction with any other antenna or transmitter.

The antennas used for this transmitter must be installed to provide a separation distance of at least 0.5 cm from all persons and must not be co-located or operating in conjunction with any other antenna or transmitter.

This device complies with Part 15 of the FCC Rules. Operation is subject to the following two conditions: (1) This device may not cause harmful interference, and (2) This device must accept any interference received, including interference that may cause undesired operation.

WARNING

1. FOR OUTDOOR USE:



To reduce the risk of fire or electric shock, do not expose this apparatus to rain or moisture.

2. UNDER WET LOCATION:

Apparatus should not be exposed to dripping or splashing and no objects filled with liquids, such as vases should be placed on the apparatus.

3. SERVICE INSTRUCTIONS:

CAUTION - These servicing instructions are for use by qualified service personnel only. To reduce the risk of electric shock, do not perform any servicing other than that contained in the operating instructions unless you are qualified to do so.

	
	This symbol indicates that dangerous voltage constituting a risk of electric shock is present within this unit.
	This symbol indicates that there are important operating and maintenance instructions in the literature accompanying this unit.

Disposal

Dispose of any unusable devices or batteries responsibly and in accordance with any applicable regulations.



Disposing of used batteries with domestic waste is to be avoided!

Batteries / NiCad cells often contain heavy metals such as cadmium (Cd), mercury (Hg) and lead (Pb) that makes them unsuitable for disposal with domestic waste. You may return spent batteries/ accumulators free of charge to recycling centres or anywhere else batteries/accumulators are sold.

2005-08-13

By doing so, you contribute to the conservation of our environment!

IC

This device complies with Industry Canada licence-exempt RSS-123 ISSUE 2 / RSS-310 ISSUE 3 standards. Operation is subject to the following two conditions:

- (1) this device may not cause interference, and
- (2) this device must accept any interference, including interference that may cause undesired operation of the device.

Le présent appareil est conforme aux CNR d'Industrie Canada applicables aux appareils radio exempts de licence. L'exploitation est autorisée aux deux conditions suivantes :

- (1) l'appareil ne doit pas produire de brouillage, et
- (2) l'utilisateur de l'appareil doit accepter tout brouillage radioélectrique subi, même si le brouillage est susceptible d'en compromettre le fonctionnement.

I. Part Names. Fig. 1

1. ACT-5801 Single-Channel Receiver

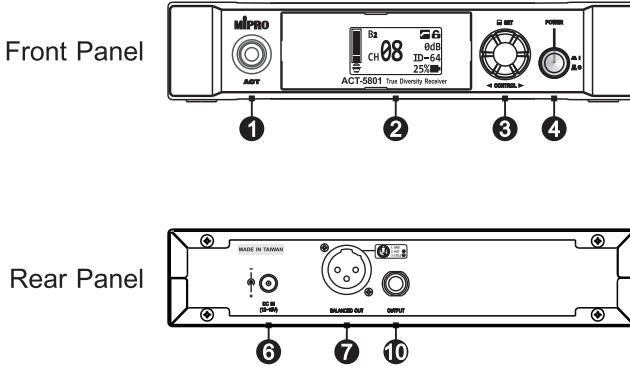

2. ACT-5802 Dual-Channel Receiver

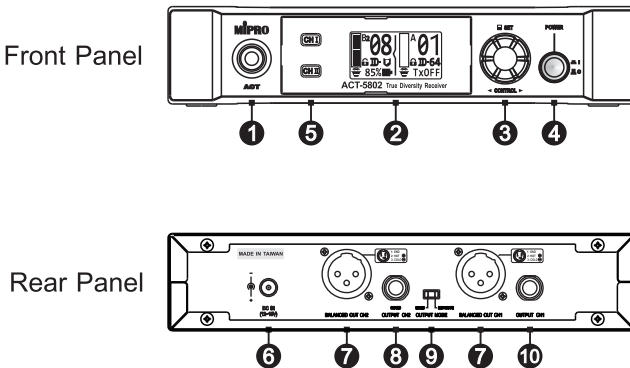
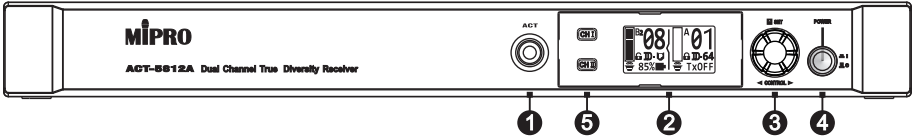

Fig. 1

3. ACT-5812A Dual-Channel Receiver

Front Panel



Rear Panel

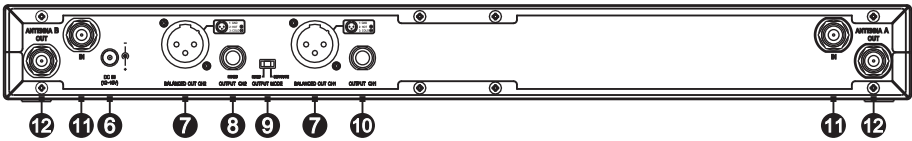

4. ACT-5814A Quad-Channel Receiver

Front Panel



Rear Panel

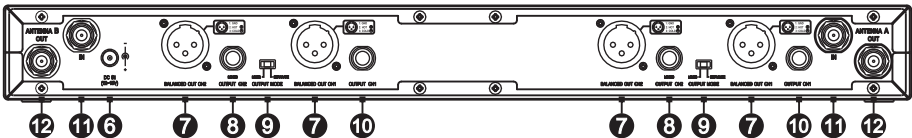
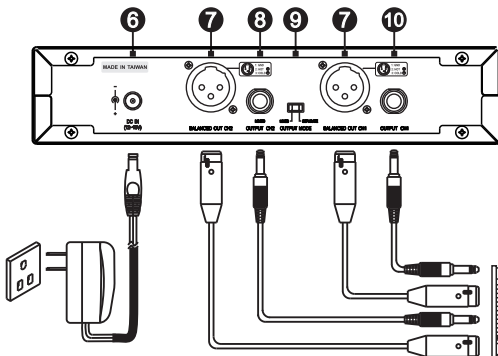

Fig. 1

- ❶ Channel sync ACT button
- ❷ OLED screen
- ❸ Parameter Control Knob
- ❹ POWER button
- ❺ Channel I or II Selector
- ❻ DC Input Jack: center pin is positive and sleeve is ground
- ❼ Balanced Audio Output Socket: 3-pin XLR type connector
- ❽ Mixed Unbalanced Audio Output Jack: 6.3 Ø (1/4") phone-jack type connector
- ❾ Mixed and Separate Output Switch
- ❿ Unbalanced Audio Output Jack: 6.3 Ø (1/4") phone-jack type connector
- ⓫ TNC Antenna Connector
- ⓬ TNC Connector for Daisy Chain Output

II. Receiver Installation

1. Plug DC plug into the DC-input jack **6** and the power cord, into a power outlet. (Various outlets fitting the standards of various countries are available for this unit. Standard Taiwan Voltage: AC 110V) Fig. 2
2. Audio Output Connection. Fig. 2:
 - (A) Use audio output cables with “XLR” or “Canon” type connectors, connect one end to the balanced output jacks **7**, of the receiver, and the other end to the “MIC IN” input jack of the mixer or amplifier. (The configuration of the 3-pin connector is as shown in Fig. 3)
 - (B) Use audio output cable attached with “6.3 Ø Phone Jack” type, connect one end from the unbalanced output jack **8** **10**, of the receiver and the other end to the “LINE-IN” input jack of the mixer/amplifier. Mixed and Separate Output Switch **9** for Mixed or Separate output.



(All Pictures shown are for illustration purpose only)

Fig. 2

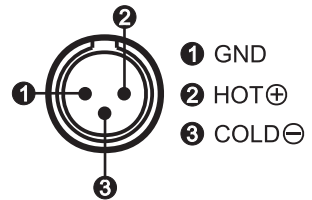

Fig. 3

3. ACT-5812A | ACT-5814A Antenna Installation & Daisy Chain:

(A) Install supplied 5.8 GHz receiver TNC antenna A & B at TNC Antenna Connector ❶ . Fig. 4

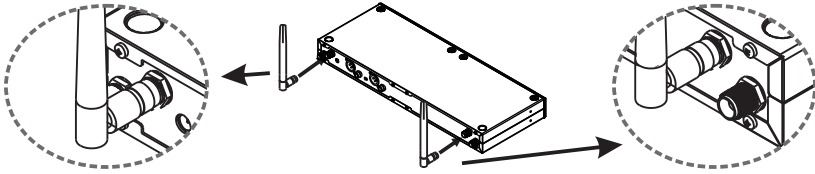

Fig. 4

(B) TNC connector for daisy chain output ❷ can be daisy-chained up to three receivers (one master receiver plus two daisy-chained receivers) one by one for optimal reception quality. Fig. 5

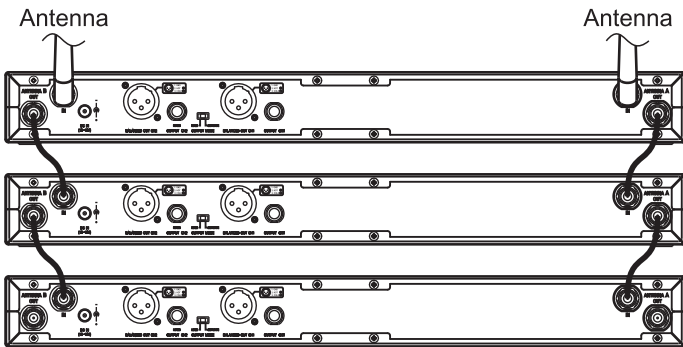

Fig. 5

(C) Install the optional rack mount kit & rear-to-front cables for improved reception quality. Fig. 6

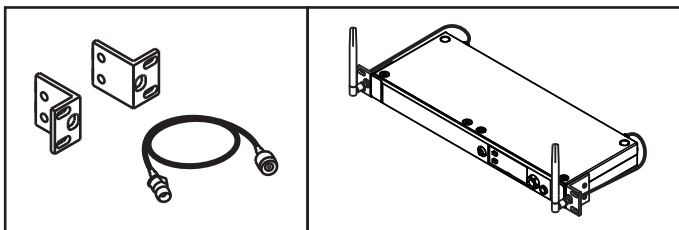

Fig. 6

III. Receiver Operating Instructions

1. Prior to powering on the receiver, ensure all transmitters are turned off and the mixer's volume control is set to a minimized setting. Press Power button ④ to power on. OLED screen ② will be lit. Fig. 7

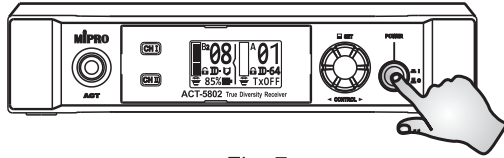

Fig. 7

2. Receiver Home Screen status once powered on. Fig. 8:

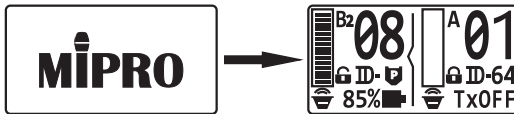

Fig. 8

3. The microphone volume should first be set with correct gain level.
4. Press Channel Selector ⑤ for channel 1 or 2 setting. Applicable channel will be lit once pressed and channel arrow shown ⑱ .
5. Once the transmitter is powered on, the battery indicator ⑮ on the receiver display will be lit.
6. The microphone volume should first be set with correct gain level by the Rotary Knob ③ in the audio output intensity of the function option. Then adjust for ideal volume of mixer or amplifier.

7. Ensure mixer or amplifier's volume control is set to a minimized setting. Once an audio signal is received from the transmitter, the AF (audio) meter level **13** glows based on signal strength.
8. No sound output from the amplifier or transmitter status indicates system operation or is not normal and must be adjusted or inspected.

IV. Receiver Rackmount Installation

1. Install and fasten the rackmount kits on the receiver. Fig. 9

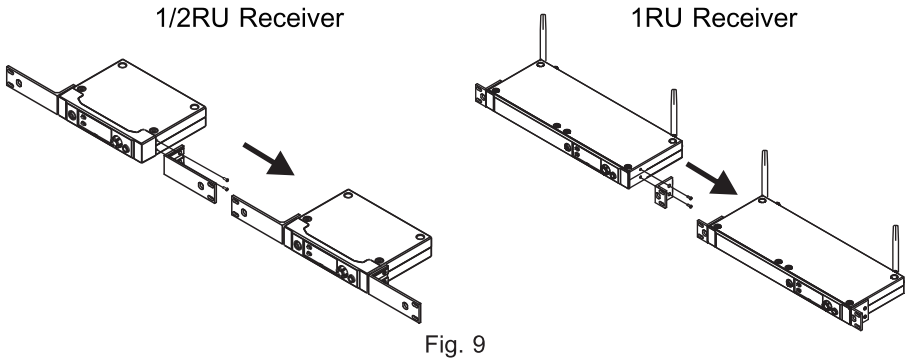

Fig. 9

2. Optional rackmount kits for one 1/2RU receiver or rackmount kits for one 1RU receiver. Fig. 10

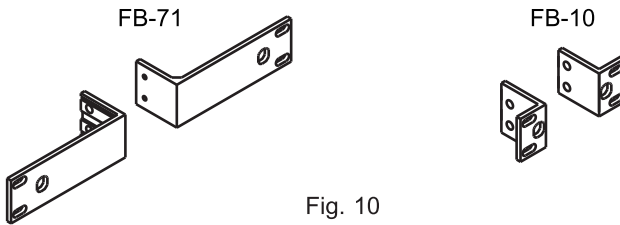

Fig. 10

Rackmount kit for one 1/2RU receiver

Rackmount kit for one 1RU receiver

3. Can be installed into an EIA standard rackmount kits. Fig. 11
4. For ideal reception and performance, install the receiver at least 1 meter (3 feet) above the ground and away from EMI / RFI “noise” sources. Fig. 12

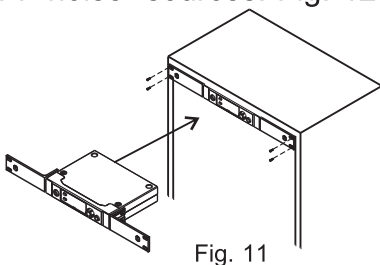

Fig. 11

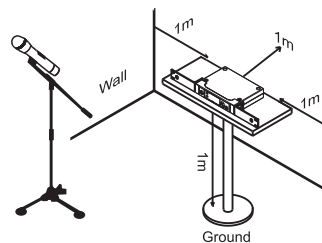

Fig. 12

5. Install and fasten two 1/2RU single-channel or dual-channel receivers side-by-side into a 1RU receiver:

- (A) Remove top & bottom screws. Fig. 13
- (B) Install top & bottom connecting plates to secure both receivers. Fig. 14
- (C) Install and fasten with receiver rackmount kit. Fig. 15
- (D) Optional FB-10 rackmount kit.

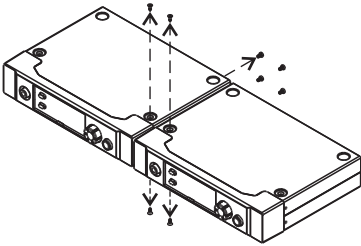

Fig. 13

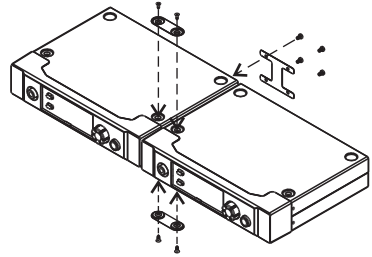

Fig. 14

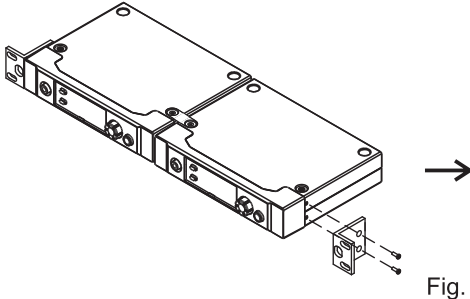

Fig. 15

V. Receiver Home Screen

Displays Receiver and Transmitter Status. Fig. 16:

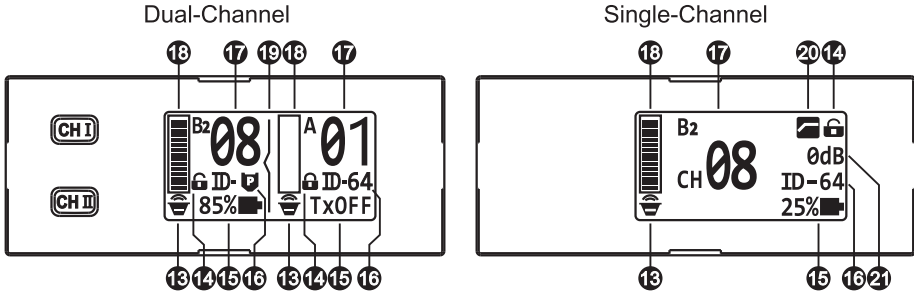

Fig. 16

- 13 Transmitter AutoWakeUp & Mute indicator
- 14 Parameter Locked status
- 15 Displays remaining transmitter battery level in percentage.
TxOFF is shown when transmitter is powered off.
- 16 Displays the selected Transmitter ID Code
- 17 Displays the selected Group and Channel number
- 18 Indicates audio signal level
- 19 Selected Channel arrow (Left Channel I; Right Channel II)
- 20 Low Cut Filter
- 21 Selected Audio Gain in dB

VI. Parameter Control Knob. Fig. 17

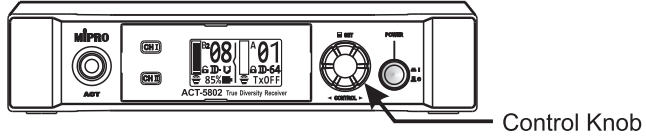
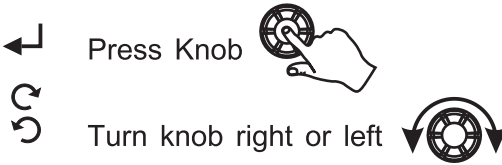

Fig. 17

1. Setting Parameters:



2. Receiver Parameters, see Fig. 18:

GRP&CH	B2 -01
ID-Code	64
AudioGain	20dB
LowCut	ON



AutoWakeUp	ON
ChannelScan	
SetLock	NO
Version?	



ChannelScan	
SetLock	NO
Version?	
Exit&Save	

Fig. 18

- (A) Press once to activate parameter setup.
- (B) Turn and select a status bar. Press once to activate parameter setting.
- (C) Turn right or left to one of the programmed parameter value.
- (D) To save changes, turn and locate Exit & Save status bar, press once to save and return to home screen.

3. Setting GRP & CH, see Fig. 19:

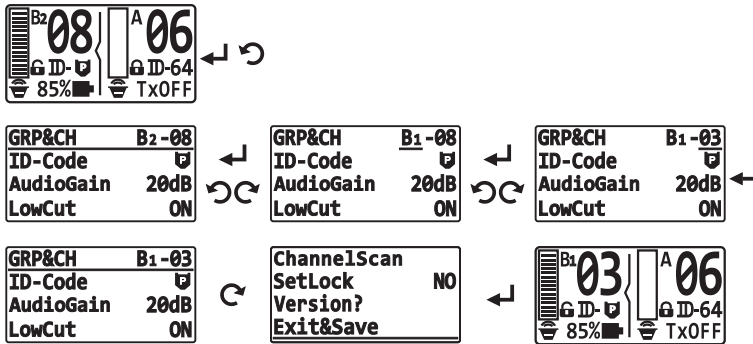

Fig. 19

- (A) Press knob once at Home Screen, turn and locate GRP & CH status bar. Press once to activate parameter setting.
- (B) Turn right or left to one of the programmed parameter value.
- (C) Press once to accept change. To save changes, turn and locate Exit & Save status bar, press once to save and return to home screen.
- (D) Press ACT sync button to synchronize the newly changed with transmitter once GRP & CH setup is done.
- (E) Two programmed groups of channels are available for selection. Group A and Group B (B1+B2) have 12 and 24 channels, respectively. 64 IDs and a specific ID is allowed to be set for each channel to prevent the same channel interfered at the same space. We recommend using channels in Group A for challenging RF & interference environments due to its higher anti-interference ability. We recommend using channels in Group B for more interference-free channels operation or optimal audio latency (cleaner RF, less interference environments). However, do not mix Group A channels and Group B channels.

4. Setting ID-Code, see Fig. 20:

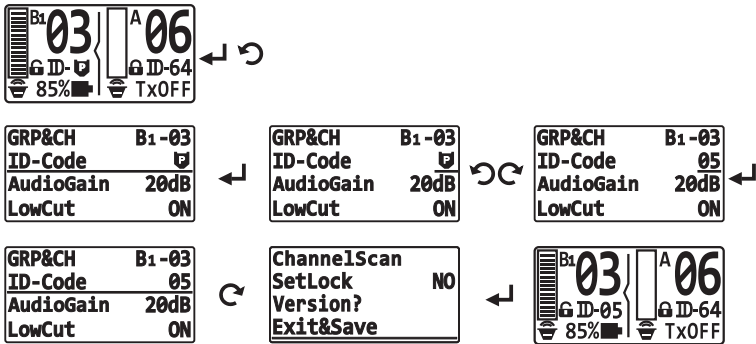

Fig. 20

- Press knob once at Home Screen, turn and locate ID-Code status bar. Press once to activate parameter setting.
- Turn right or left to one of the programmed parameter value.
- Press once to accept change. To save changes, turn and locate Exit & Save status bar, press once to save and return to home screen.
- Press ACT sync button to synchronize the newly changed with transmitter once ID-Code setup is done.
- A total of 64 different IDs (01-64) can be selected for each channel. A proprietary 65th Pairing Mode (**P**) can be selected for 1-to-1 transmitting and preventing audio signals received from other receivers.

5. Setting Audio Gain, see Fig. 21:

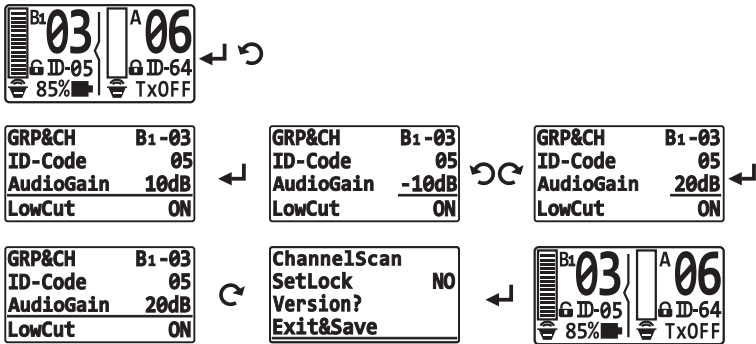

Fig. 21

- Press knob once at Home Screen, turn and locate Audio Gain status bar. Press once to activate parameter setting.
- 10 dB to +20 dB knob adjustment in 1 dB increase or decrease step increment.
- Press once to accept change. To save changes, turn and locate Exit & Save status bar, press once to save and return to home screen.
- Setting recommendation: MIC OUT: 0 dB, LINE OUT: +14~16 dB.
- Note: For unbalanced (6.3 Ø) audio output jacks connection, to set the Audio Gain at +14~16 dB is required.

6. Setting Low Cut Filter, see Fig. 22:

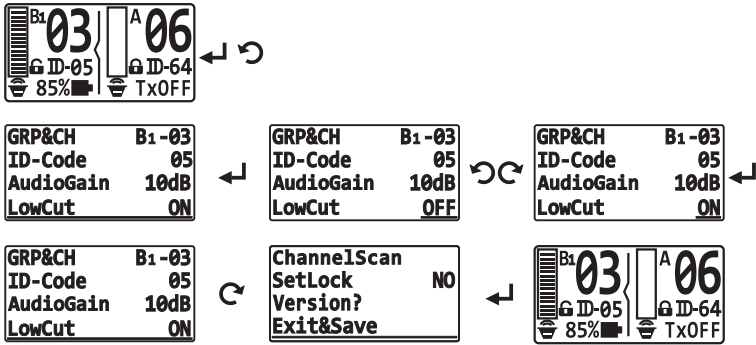

Fig. 22

- (A) Press knob once at Home Screen, turn and locate Low Cut status bar. Press once to activate parameter setting.
- (B) Turn right or left to ON or OFF position.
- (C) Press once to accept change. To save changes, turn and locate Exit & Save status bar, press once to save and return to home screen.

7. Setting Auto Wake Up, see Fig. 23:

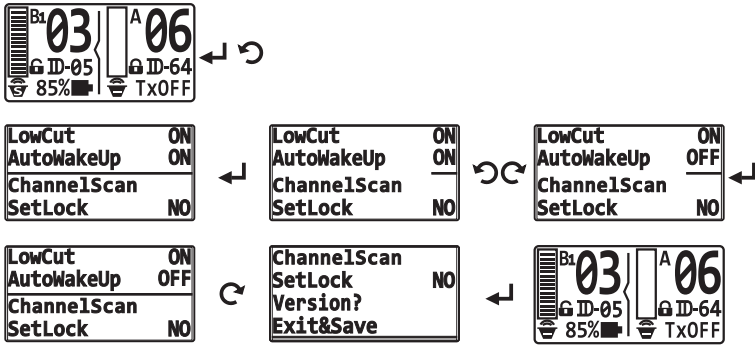



Fig. 23

- (A) Press knob once at Home Screen, turn and locate Auto Wake Up status bar. Press once to activate parameter setting.
- (B) Turn right or left to ON or OFF position.
- (C) Press once to accept change. To save changes, turn and locate Exit & Save status bar, press once to save and return to home screen.
- (D) Press ACT sync button to synchronize the newly changed with transmitter once Auto Wake Up setup is done.
-  denotes Auto Wake Up function OFF.
-  denotes Auto Wake Up function ON S in ON position and \ & no audio bars appear in audio meter in Muted position.
- (E) Note: The transmitter have to provide Auto Wake Up function.

- (F) The transmitter audio is going to be muted automatically if a powered-on transmitter is idled for approximately 10 seconds and the action indicator starts flashing and “TxOFF” will be shown on the screen. Fig. 25; When detects a movement, the transmitter will be activated and the action indicator remains lightened.

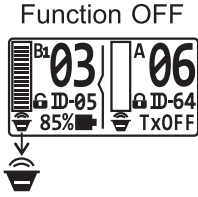

Fig. 24

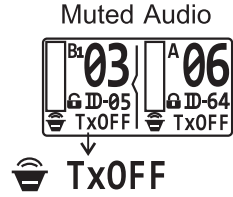
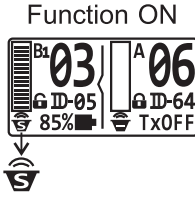

Fig. 25

8. Setting Channel Scan, see Fig. 26:

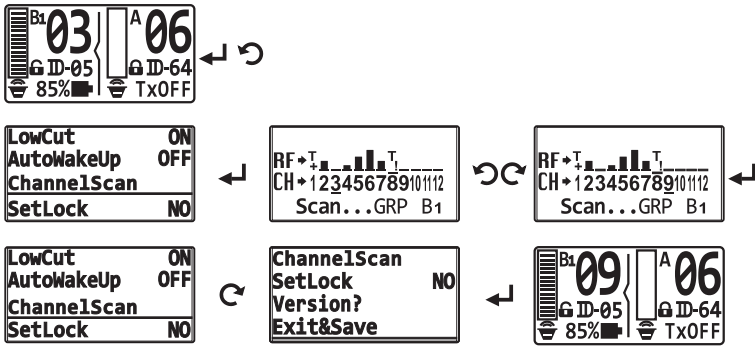

Fig. 26

- (A) Press knob once at Home Screen, turn and locate Channel Scan status bar. Press once to activate scanning for a clear channel.
- (B) After scanning, turn knob right or left to select the least interference channel. This selected XX channel will appear Channel & ID “XX”-ID number here. Press once to accept change. To save changes, turn and locate Exit & Save status bar, press once to save and return to home screen.
- (C) To scan for 12 channels in Group A, Group B (B1/B2), make sure the “XX” Channel & ID “XX”-ID number is already programmed to Group A, Group B (B1/B2).
- (D) Press ACT sync button to synchronize the newly changed with transmitter once Channel Scan setup is done.
- (E) Channel Scan scans the surrounding environment for RF signal strength to enable selection of the least interference channel(s) for performance.

(F) CAUTION:

- " T_+ " denotes current MIPRO transmitter is in operation and synced with this MIPRO receiver.
- " $T_!$ " denotes other MIPRO transmitter is in operation and synced with another MIPRO receiver.
- "■" denotes this channel has a severe environmental interference.
- "—" denotes this channel has a least/minor environmental interference.
- "9" denotes the selected receiver channel.

9. Setting Parameter Lock, see Fig. 27:

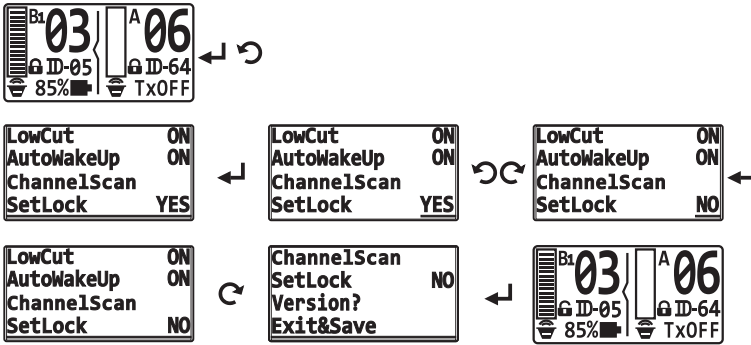

Fig. 27

- (A) Press knob once at Home Screen, turn and locate Set Lock status bar. Press once to activate parameter setting.
- (B) Turn right or left to NO or YES position.
 NO position = parameters are not locked .
 YES position = parameter are locked and cannot be changed .
- (C) Press once to accept change. To save changes, turn and locate Exit & Save status bar, press once to save and return to home screen.
- (D) Once locked icon is displayed, parameter values can no longer be programmed or changed. Change icon from YES to NO if parameter values need to be programmed or changed.



Fig. 28

10. Version? status, see Fig. 29:

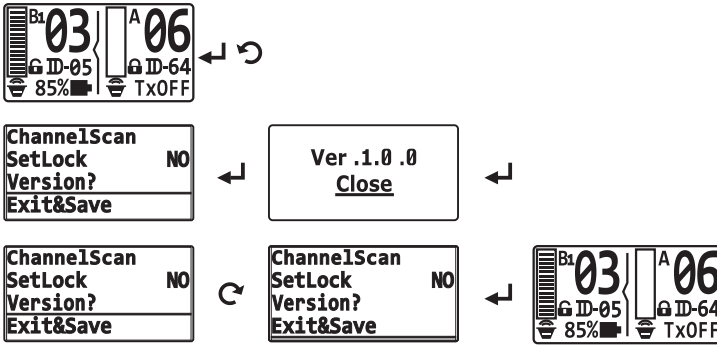

Fig. 29

- (A) Press knob once at Home Screen, turn and locate Version?. Press once to see current version.
- (B) Turn and locate Exit & Save status bar, press once returns to home screen.
- (C) Current version maybe changed.

11. Transmitter Mute Icon, see Fig. 30:

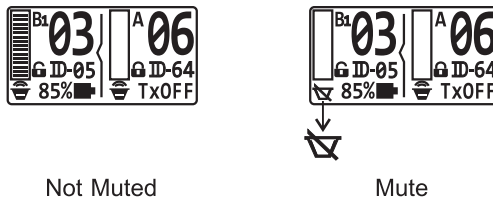

Fig. 30

When ACT-58TC | ACT-58T transmitters setup MUTE, the AF level is 0.

12. Setting Transmitter ACT Synchronization (sync):

- (A) Press the ACT sync button on the receiver, ACT... icon **1** appears.
Within 10 seconds, align the transmitter infrared (IR) port and receiver's ACT button with each other and within 30 cm. Fig. 31
- (B) If receiver display shows FAIL, it indicated the sync was done unsuccessfully. Try again when sync fails.
- (C) Change is saved automatically, even when power is turned off.

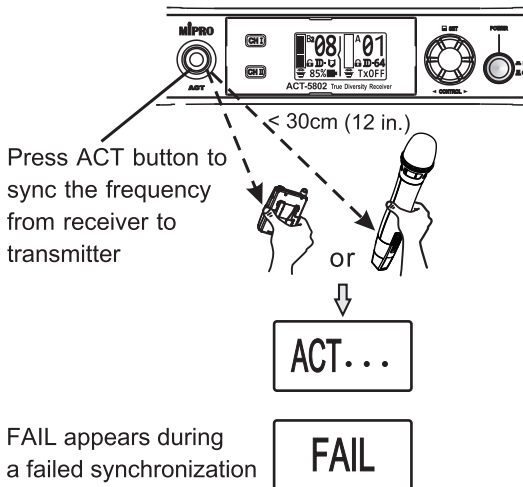

Fig. 31

VII. Transmitter Battery Meter (receiver display)

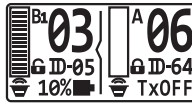

Fig. 32

1. The battery meter displays in percentage in receiver illuminates when transmitter is powered on. Recharge the transmitter battery (or replace with a charged battery pack) immediately when battery indicators fall to 10% showing.
2. TxOFF is shown when transmitter is powered off. Fig. 32

VIII. Caution

1. Position the MIPRO receiver at least 5-meter away from 5.8 GHz Wi-Fi or other 5.8 GHz transmitting devices.
2. User can scan environment for current 5.8 GHz Wi-Fi devices being used and signal strength with smartphone app. Ascertain position the MIPRO receiver away from these 5.8 GHz Wi-Fi transmitting devices.
3. A clear, line-of-sight provides the optimal reception range between the transmitting antenna and receiver.
4. Power supply voltage should not be less than 12V DC and not higher than 15V DC. Deficient current causes operating voltage instability or malfunction and exceeding current causes shorter the product life cycle and possible short or damaging circuits.

IX. Notes

1. Design and specifications are subject to change without prior notice. Refer to actual product in the event of product discrepancy.
2. Frequency range and maximum deviation comply with the regulations of different countries.

MIPRO[®]
MICROPHONE PROFESSIONALS

MIPRO Electronics Co., Ltd

Headquarters: No. 814, Beigang Rd., Chiayi City 600079, Taiwan
Tel : +886.5.238.0809
www.mipro.com.tw

Fax : +886.5.238.0803
mipro@mipro.com.tw



All rights reserved. YM 020/07

Do not copy or forward without prior approvals MIPRO.

Specifications and design subject to change without notice.



2 CE650B