

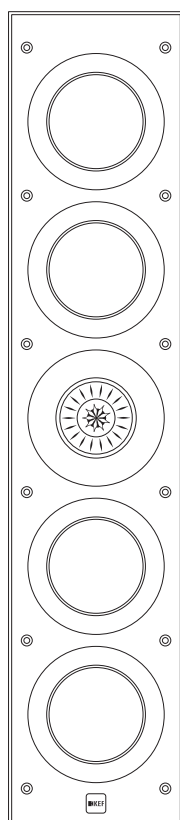

T H E R E F E R E N C E



Owner's Manual



Ci5160REF-THX

Introduction

(FRA) Utilisation (DEU) Einleitung (SPA) Introducción (JPN) はじめに (CHI-S) 引言

- ENG** Thank you for purchasing this KEF Reference series custom installation loudspeaker. These products have been designed for dry-lined, stud partition walls and ceilings and for suspended ceilings and will deliver many years of superb sound quality.
- FRA** Merci d'avoir choisi les enceintes à installation personnalisée de la série Reference de KEF. Ces produits sont conçus pour des cloisons et plafonds lattés et plâtrés ainsi que pour les faux-plafonds, vous garantissant de nombreuses années de qualité sonore d'exception.
- DEU** Vielen Dank, dass Sie sich für diesen Einbaulautsprecher der KEF Reference-Serie entschieden haben. Diese Produkte wurden für Trockenbau-Ständerwände und -decken sowie für Hängedecken entworfen und werden Ihnen über viele Jahre hinweg erstklassige Klangqualität bieten.
- SPA** Gracias por haber adquirido los altavoces de instalación personalizada serie Reference de KEF. Estos productos han sido diseñados para paredes divisorias prefabricadas y para falsos techos, garantizándole años de excelente calidad de sonido.
- JPN** KEF Reference シリーズカスタム・インストレーション・ラウドスピーカーをご購入いただき、ありがとうございます。本シリーズは、乾式スタッド壁と天井および吊り天井への取り付けを目的として設計されており、長年にわたって優れた音質をお届けします。
- CHI-S** 感谢您购买 KEF Reference 系列自定义安装扬声器。该产品专为预制立筋隔断墙和天花板以及吊顶设计，为您带来经久不衰的最佳音质。

Warning

(FRA) Avertissement (DEU) Warnung (SPA) Atención (JPN) 警告 (CHI-S) 警告

- ENG** Installation should be performed by an installer who is skilled in the proper use of hand and power tools, knowledge of local building and fire codes, and who is familiar with the environment behind the wall or ceiling where the speaker is being installed. No attempt should be made to install these loudspeakers unless you are sure you will not be cutting through electric cables, water or gas pipes, or supporting joists. Ensure the loading on the wall or ceiling will support the weight of these assemblies.
- FRA** L'installation doit être réalisée par un installateur ayant des qualifications dans la manipulation d'outils à main et électriques, des connaissances sur les codes locaux du bâtiment et des incendies et au courant de ce qui se trouve derrière la cloison ou le plafond où les enceintes seront installées. N'essayez pas d'installer ces enceintes vous-même sauf si vous êtes sûr qu'aucun câble électrique, canalisation d'eau ou de gaz ou sous-poutre ne risquera d'être sectionné. Vérifiez que la charge sur le mur ou le plafond supportera le poids de ces installations.
- DEU** Der Einbau sollte von einem Installateur vorgenommen werden, der in der fachgerechten Verwendung von Hand- und Elektrowerkzeugen bewandt ist, die örtlichen Bau- und Brandschutzvorschriften kennt und mit der Umgebung hinter der Wand oder der Decke, in die der Lautsprecher eingelassen werden soll, vertraut ist. Unter keinen Umständen sollten Sie versuchen, diese Lautsprecher einzubauen, wenn Sie nicht absolut sicher sind, hierbei keine Stromkabel, Wasser- oder Gasleitungen oder Stützträger zu durchtrennen. Stellen Sie sicher, dass die Wand bzw. Decke ausreichend belastbar ist, um das Gewicht dieser Baugruppen zu tragen.
- SPA** La instalación debe ser realizada por un instalador con experiencia en el correcto uso de herramientas manuales y eléctricas, con conocimiento de las normativas locales de construcción e incendios, y que sepa lo que se encuentra tras la pared o el techo donde se va a instalar el altavoz. No deberá instalar los altavoces salvo que esté seguro de que no corte cables eléctricos, tuberías de agua o gas, ni afecte a vigas maestras. Compruebe que la pared o el techo pueda soportar el peso de estas instalaciones.
- JPN** 本製品の取り付けは、手工具および電動工具を適切に使用でき、地域の建物・消防基準法の知識があり、スピーカーを取り付ける壁および天井の状況をよく知っている設置者が行ってください。電線・水道・ガス管、または梁を破損しないことが確かな場合以外は、取り付けを行わないでください。壁または天井の荷重がスピーカーアセンブリーの重量を支えられることを確かめてください。
- CHI-S** 安装必须由安装人员执行，这些安装人员能够熟练正确地使用手工及电动工具，熟悉当地建筑及消防条例相关知识，并且熟悉扬声器安装外墙后及天花板后的环境情况。在无法保证不切断电线、水管、煤气管或支撑托梁的情况下，请勿尝试安装扬声器。请确保安装所在的墙壁或天花板可承载所有装配的重量。

Important Points

(FRA) Points importants (DEU) Wichtige Punkte (SPA) Puntos importantes (JPN) 重要安全項目 (CHI-S) 重要安全事項

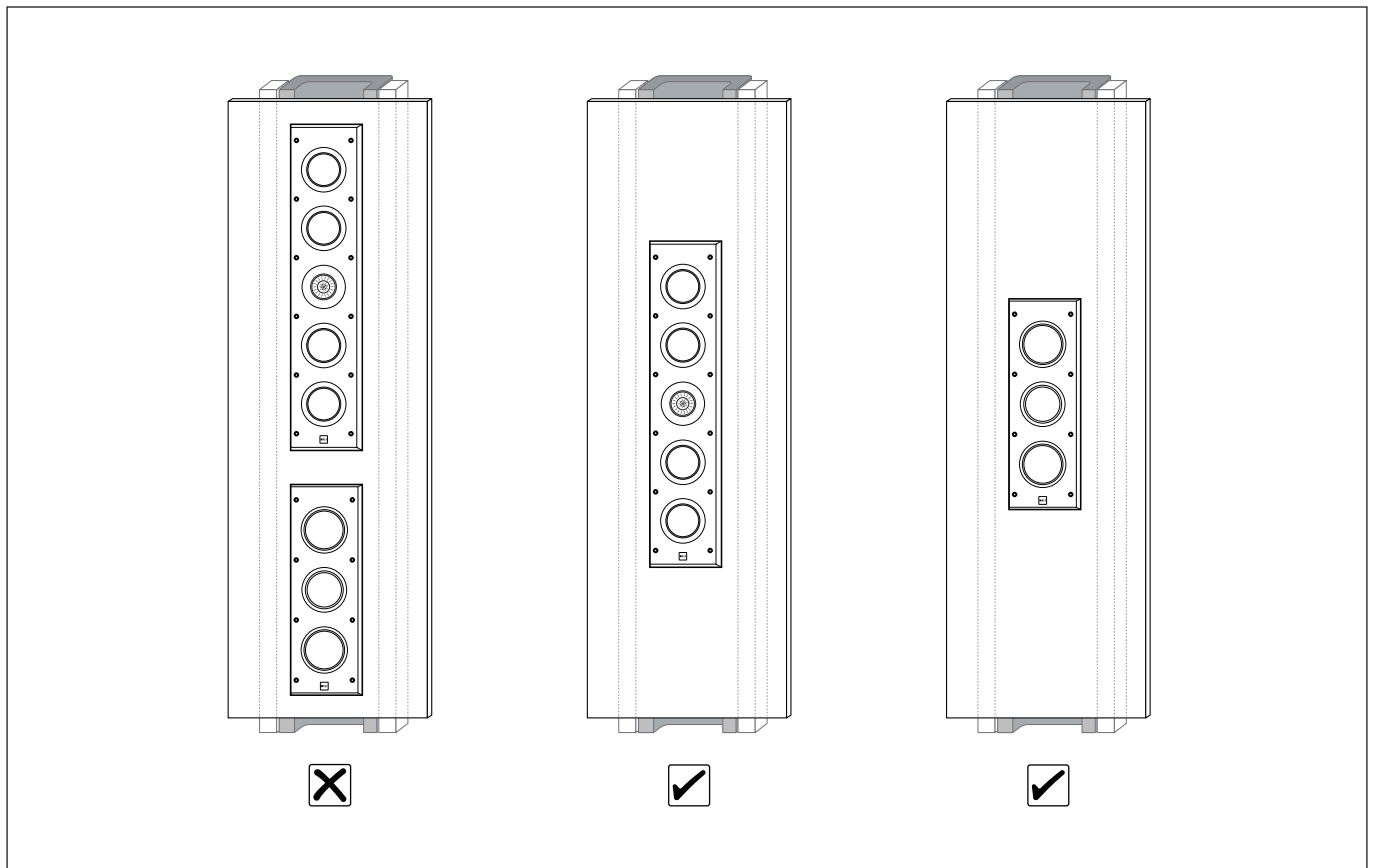
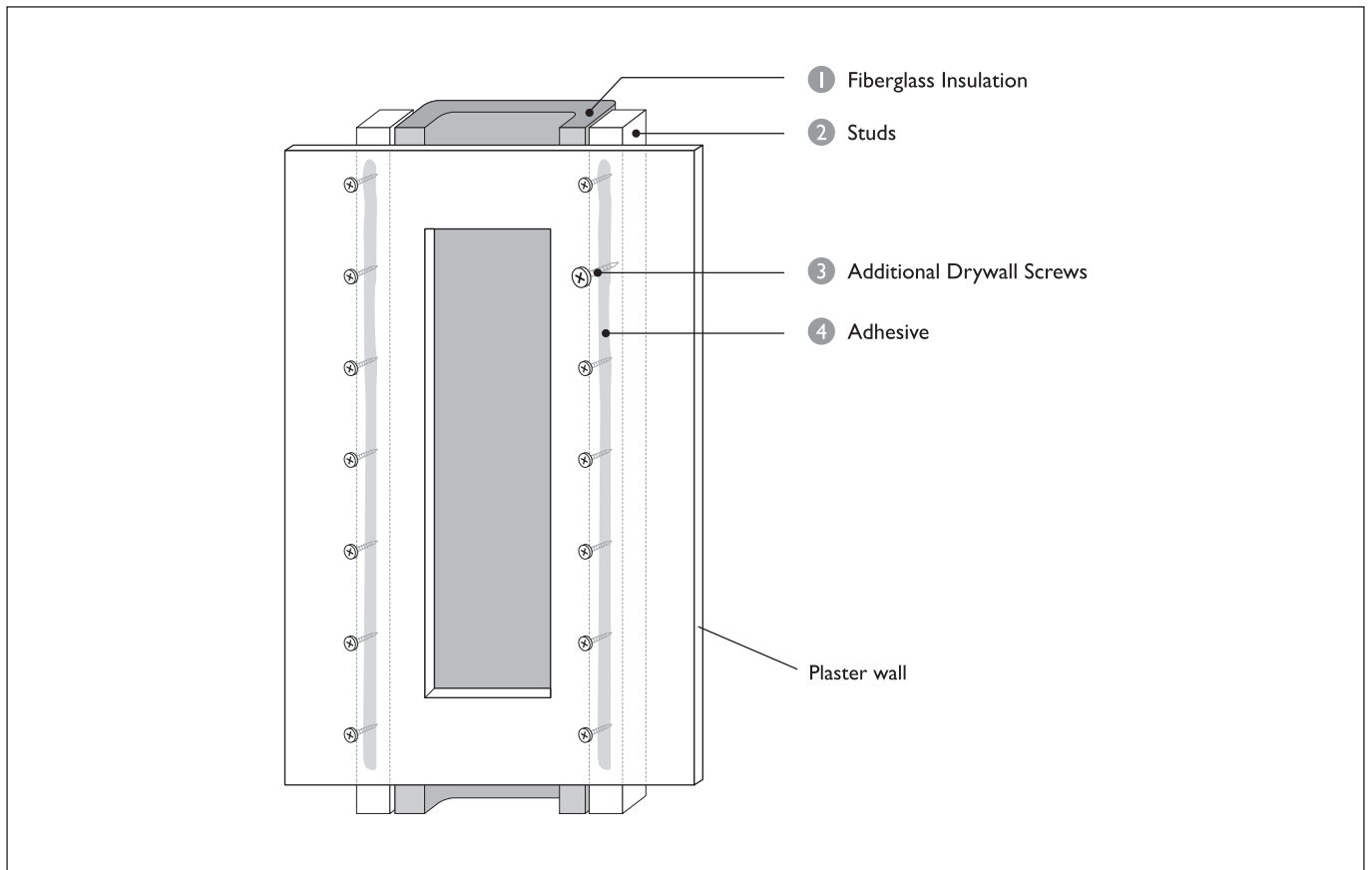

Installation

(FRA) Installation (DEU) Installation (SPA) Instalación (JPN) 取り付け (CHI-S) 安装程序 (CHI-T) 安装程式 (KOR) 설치

1

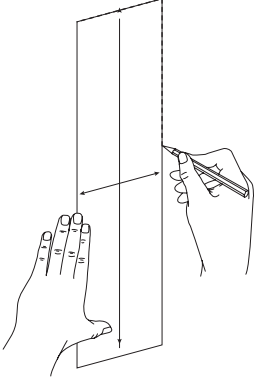

2

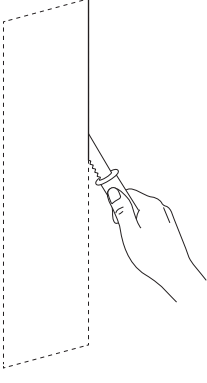

3

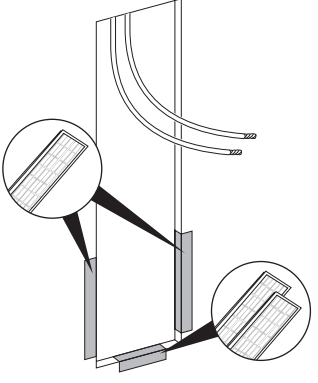

4

Single amp

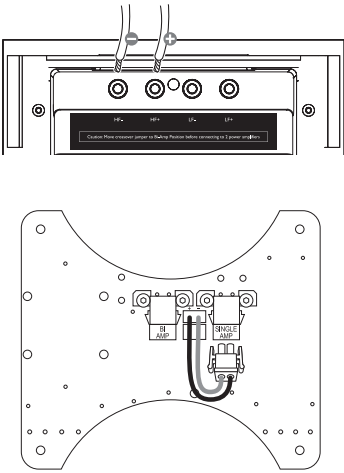

Bi-amp

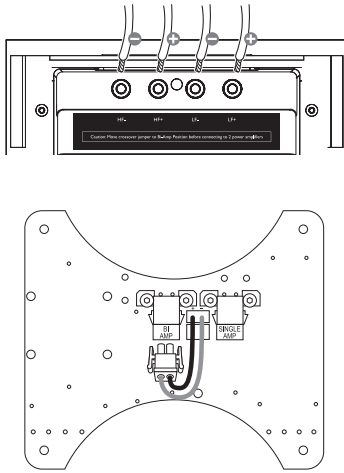

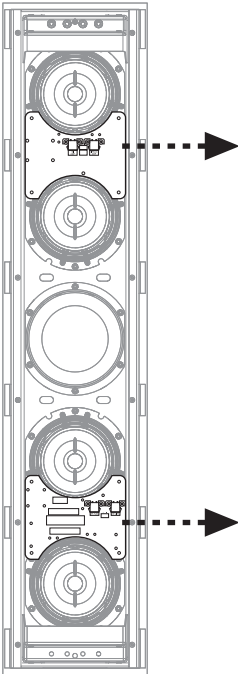

5

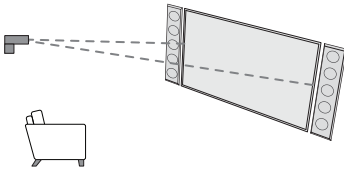

HF Flat

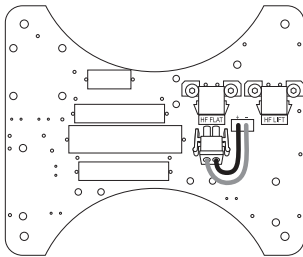

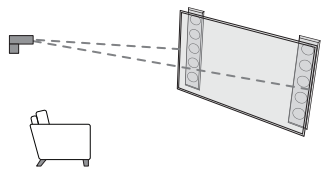

HF Lift

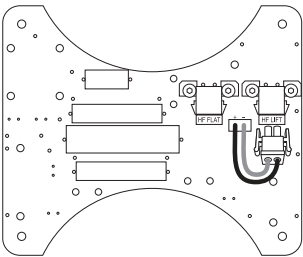

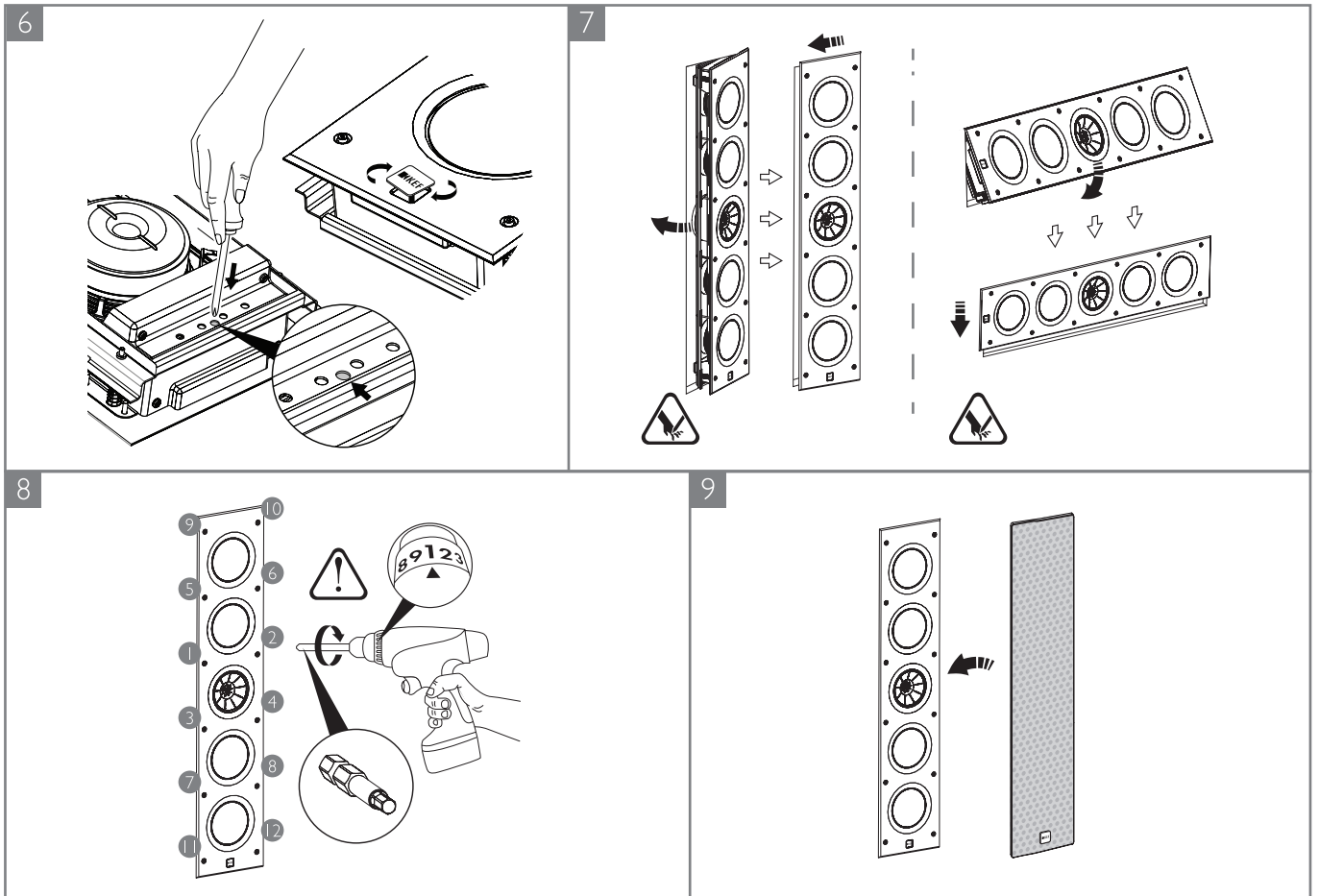

Decoration

(FRA) Finition (DEU) Dekoration (SPA) Ornamantación (JPN) 装飾 (CHI-S) 装饰 (CHI-T) 裝飾 (KOR) 외부 디자인

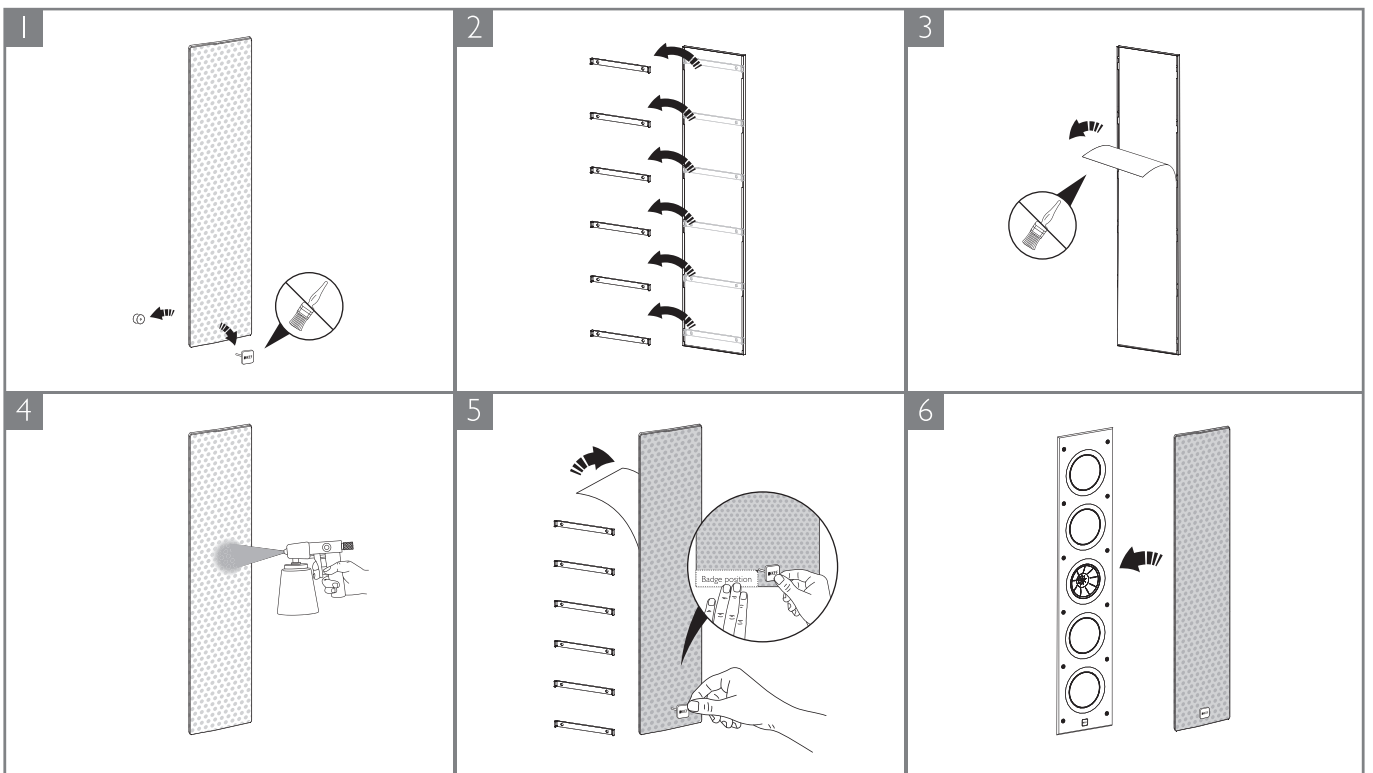

Specifications

(FRA) Spécifications (DEU) Technische daten (SPA) Especificaciones (JPN) スペック(CHI-S) 规格 (KOR) 주요사양

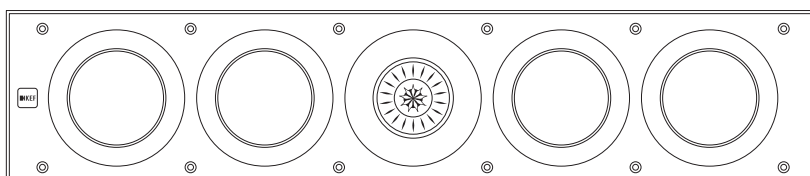

| | | |
|---|---|-----------------------|
| Model | Ci5 I60REF-THX | |
| Series | REFERENCE series | |
| Nominal impedance | 4Ω | |
| Sensitivity (2.83V/ 1m) | 90dB | |
| Frequency response open-backed | 40Hz – 28kHz | |
| Crossover frequency | 400Hz, 2.8kHz | |
| Drive units | LF | 4 × 160mm (6.5in.) |
| | MF | 125mm (5.25in.) Uni-Q |
| | HF | 25mm (1in.) |
| Recommended amplifier power | 40 - 500W | |
| Product external dimensions (H × W × D) | 1070 × 230 × 105.7 mm (42.13 × 9.06 × 4.16 in.) | |
| Cut-out dimensions (H × W) | 1052 × 209 mm (41.42 × 8.23 in.) | |
| Net Weight | 22.0kg (48.5lbs) | |
| Mounting depth from surface | 99mm (3.9in.) | |
| Grille | White Metal Mesh Grille Optional Black Fabric Grille | |
| Optional rough in frame | RIF5 I60L | |
| Optional rear enclosure | None | |

*THX Ultra Certified

KEF reserves the right, in line with continuing research and development, to amend or change specifications. E&OE.

THX and the THX logo are trademarks of THX Ltd., registered in the U.S. and other countries. All rights reserved.

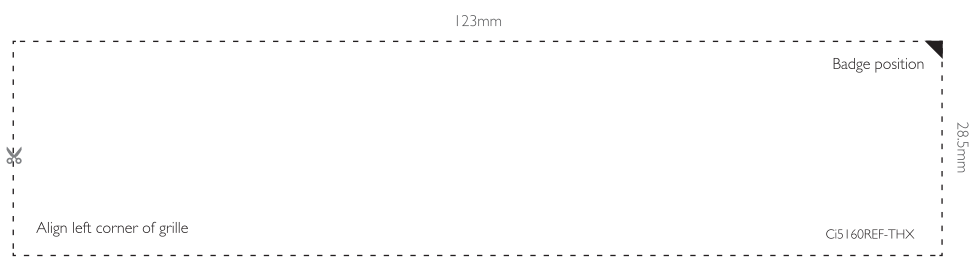



KEF.COM

United Kingdom
GP Acoustics (UK) Limited
Eccleston Road, Tovil, Maidstone,
Kent, ME15 6QP U.K.
Tel: +44 (0) 1622 672261
Fax: +44 (0) 1622 750653
Email: info@kef.com

Europe
GP Acoustics GmbH
Kruppstr. 82-100, D-45145 Essen, Germany
Tel: +49 (0) 201 17039 0
Fax: +49 (0) 201 17039 100
Email: sales@gpaeu.com

China
GP Acoustics (China) Limited
Room 2202, Diwang Commercial Centre,
5002 Shennan Road East, Shenzhen, China 518008.
Tel: +86 (755) 8246 0746
Fax: +86 (755) 8246 0125
Email: info.kefcn@gpacoustics.com

Hong Kong
GP Acoustics (HK) Limited
9/F, Building 12W, 12 Science Park West Avenue,
Hong Kong Science Park, N.T., Hong Kong
Tel: +852 2410 8188
Fax: +852 2401 0754
Email: info.kef.hk@gpacoustics.com

Taiwan
GP Acoustics (Taiwan) Limited
Room 4B, 5F, 415, Xingyi Road Sec 4,
Taipei 110, Taiwan
Tel: +886 (2) 2723 0868
Fax: +886 (2) 2723 0818
Email: info.kef.tw@gpacoustics.com

Japan
KEF Japan, 1-11-17, Honcho, Koganei-city,
Tokyo, Japan. 184-0004
Tel: +81 (0) 42 388 2030
Email: info@kef.jp

USA
GP Acoustics (US) Inc.
10 Timber Lane, Marlboro, New Jersey 07746 U.S.A.
Tel: +1 (732) 683 2356
Fax: +1 (732) 683 2358
Email: sales@kefamerica.com

KEF and Uni-Q are registered trademarks. Uni-Q and other KEF technologies are protected by worldwide patents. All text and image copyrights reserved. KEF reserves the right, in line with continuing research and development, to amend or change specifications. E&OE.

SOUND BY KEF, MAIDSTONE, U.K.
GP Acoustics (UK) Limited
Eccleston Road, Tovil, Maidstone
Kent, ME15 6QP UK





THX ULTRA

THX RECOMMENDED USE

Large Home Theaters or Living Rooms

THX CERTIFICATION FEATURES

Extended Bandwidth and Flat Frequency Response.
High Output, Low Distortion Design at 12 ft Listening Distance.
Conforms to THX Bass Management Requirements.

THX PERFORMANCE NOTES

Capable of THX Reference Level in a room up to 3,000 cubic feet (85 cubic meters).

THX.COM





Issue 2: 02.2018
P/N: