

DENON[®]

DNP-2000NE

NETWORK AUDIO PLAYER

Owner's Manual

[Front panel](#)[Rear panel](#)[Remote control
unit](#)[Index](#)

Accessories	6
Inserting the batteries	7
Operating range of the remote control unit	7
Part names and functions	8
Front panel	8
Rear panel	10
Remote control unit	12

Connections

Connecting an amplifier	18
Connecting a TV	19
Connecting this unit to the HDMI ARC terminal on a TV	19
Connecting this unit to the Optical or Coaxial terminal on a TV	21
Connecting to a device with digital audio input connectors	23
Connecting to a device with digital audio output connectors	24
Connecting a PC or Mac	25
Connecting a USB flash drive to the USB port	26
Connecting to a home network (LAN)	27
Wired LAN	27
Wireless LAN	28
Connecting to the IR control connector	29
Connecting the power cord	30



Playback

Basic operation	32
Turning the power on	32
Switching the power to standby	32
Selecting the input source	33
Listening to Internet Radio	34
Listening to Internet Radio	35
Playing back files stored on PC or NAS	36
Playing back files stored on PC or NAS	37
Playing a USB flash drive	39
Playing files stored on USB flash drives	40
Listening to music on a Bluetooth device	42
Listening to music on a Bluetooth device	43
Pairing with other Bluetooth devices	44
Reconnecting to this unit from a Bluetooth device	45
Playing digital input	46
Connecting and playing back from a TV or digital device (HDMI ARC/Coaxial/Optical 1/Optical 2)	46
Connecting and playing back from a computer (USB-DAC)	48

Getting the HEOS app	58
HEOS Account	59
Playing from streaming music services	60
Listening to the same music in multiple rooms	63
AirPlay function	67
Playing songs from your iPhone, iPod touch or iPad	68
Playing iTunes music with this unit	68
Play a song from your iPhone, iPod touch or iPad on multiple synced devices (AirPlay 2)	69
Spotify Connect function	70
Playing Spotify music with this unit	70
Convenience functions	71
Adding to HEOS Favorites	71
Playing back HEOS Favorites	72
Deleting a HEOS Favorites	72
Switching the display's brightness	73
Using the sleep timer	73



Settings

Menu map	74
Menu operation	79
Inputting characters	80
Using the number buttons	80
Using the cursor buttons	81
Audio	82
Line Out Level	82
Volume Limit	82
H/P Amplifier Gain	83
TV	84
TV Input	84
HDMI Power Off Control	85
General	86
Language	86
Auto-Standby	86
Power On Link	87
Usage Data	87
Firmware	88
Information	91
Reset	91

Network	92
Network Information	92
Network & USB-A	92
Wi-Fi	92
Bluetooth	92
Network Control	93
Friendly Name	93
Connection	94
Settings	97
Diagnostics	98
AirPlay	98
HEOS Account	99
You have not signed in	99
You have already signed in	99
Switching the function of the volume buttons on the remote control	100
Setting the remote control operation mode to network audio player operation mode	101
Setting the remote control operation mode to amplifier operation mode	101



Tips

Tips	103
Troubleshooting	105
Power does not turn on / Power is turned off	106
Operations cannot be performed through the remote control unit	107
Display on this unit shows nothing	107
No sound comes out	108
Sound is interrupted or noise occurs	109
Desired sound does not come out	110
AirPlay cannot be played back	111
USB flash drives cannot be played back	112
Bluetooth cannot be played back	113
The Internet radio cannot be played back	114
Music files on PC or NAS cannot be played back (Music server)	115
Various online services cannot be played	116
Cannot connect to a wireless LAN network	116
Music files on PC or Mac cannot be played back (USB-DAC)	118
Audio from digital devices cannot be played back (HDMI ARC/ Coaxial/Optical)	119
The input source switches to “HDMI ARC”, “Optical 1”, “Optical 2” or “Coaxial”	119
The HDMI control function does not work	119
Update/upgrade error messages	120
Resetting network settings	121
Factory Restore	122

Appendix

Playing back a USB flash drives	123
D/A converter	124
Playing back a Bluetooth device	125
Playing back files stored on a PC and NAS	126
Playing back Internet Radio	127
Last function memory	127
About HDMI	128
Explanation of terms	129
Trademark information	133
Specifications	134
Index	138







Thank you for purchasing this Denon product.

To ensure proper operation, please read this owner's manual carefully before using the product.

After reading this manual, be sure to keep it for future reference.

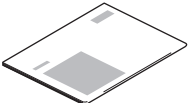
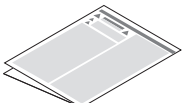
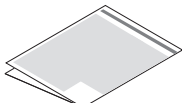
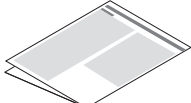
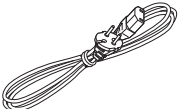
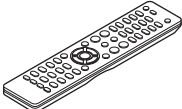
Accessories

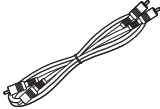
Check that the following parts are included with the product.

 <p>Quick Start Guide</p>	 <p>Safety Instructions</p>	 <p>Cautions on Using Batteries</p>	 <p>Notes on radio</p>
 <p>Power cord</p>	 <p>Remote control unit (RC-1248)</p>	 <p>2x R03/AAA batteries</p>	 <p>Audio cable</p>
 <p>IR control cable</p>	 <p>External antennas for Bluetooth/wireless connectivity</p>		



Inserting the batteries

- 1 Remove the rear lid in the direction of the arrow and remove it.

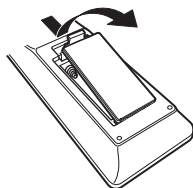

- 2 Insert two batteries correctly into the battery compartment as indicated.

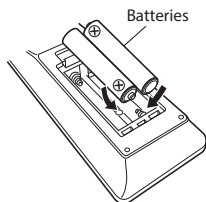

- 3 Put the rear lid back on.

NOTE

- To prevent damage or leakage of battery fluid:
 - Do not use a new battery together with an old one.
 - Do not use two different types of batteries.
- Remove the batteries from the remote control unit if it will not be in use for long periods.
- If the battery fluid should leak, carefully wipe the fluid off the inside of the battery compartment and insert new batteries.

Operating range of the remote control unit

Point the remote control unit at the remote sensor when operating it.

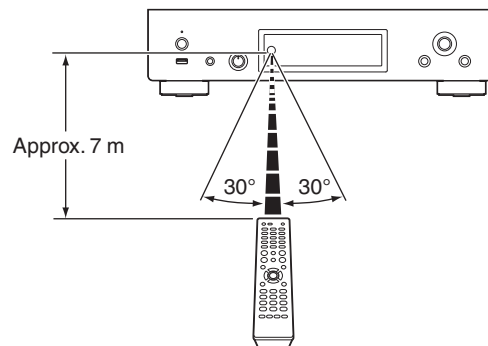

Part names and functions

Front panel

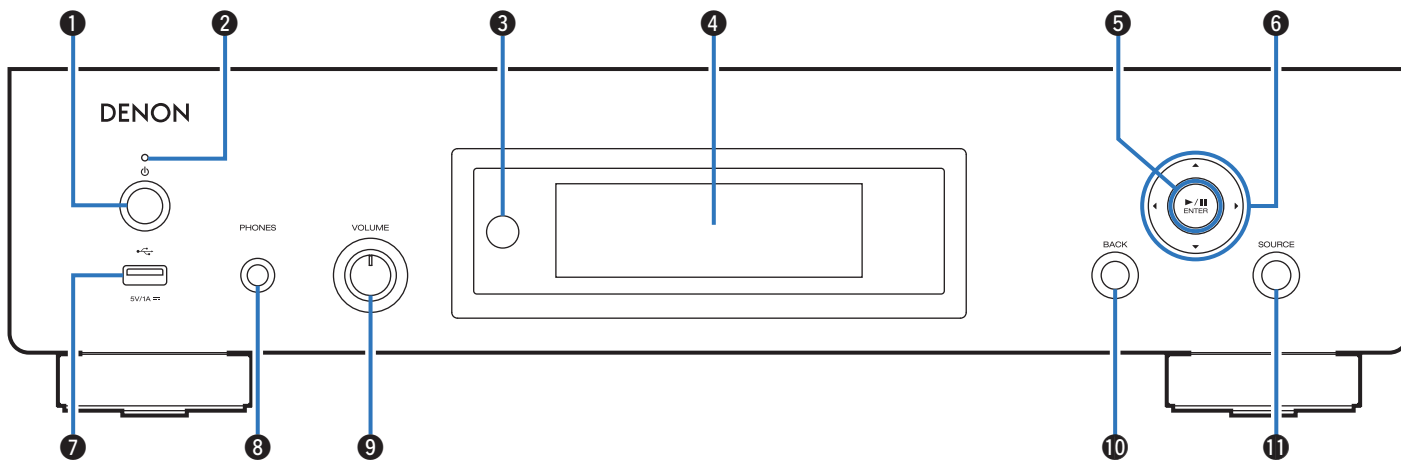

For details, see the next page.



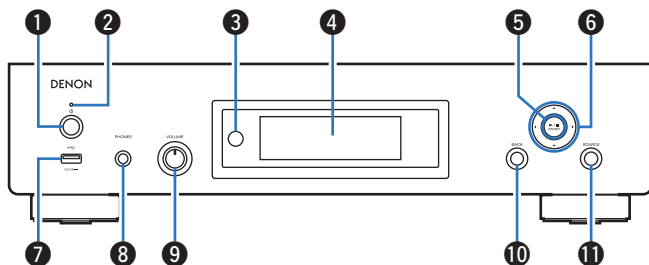

1 Power button

This turns the power on/off (standby). (👉 p. 32)

2 Power indicator

This is lit as follows according to the power status:

- Green: Power on (Product color: Black or Premium Silver)
- White: Power on (Product color: Silver Graphite)
- Off: Normal standby
- Red:
 - When “Network Control” is set to “On” (👉 p. 93)
 - When “Auto-Play” is set to “On” (👉 p. 84)

3 Remote control sensor

This receives signals from the remote control unit. (👉 p. 7)

4 Display

This displays various pieces of information.

5 Playback/Pause/ENTER button (▶/||/ENTER)

Plays back and pauses tracks, and enters the selected content.

6 Cursor buttons (Δ▽◀▶)

These select items.

7 USB port (🔌)

This is used to connect USB storages (such as USB flash drives). (👉 p. 26)

8 Headphones jack (PHONES)

Used to connect headphones.

9 Headphone volume control knob (VOLUME)

Adjusts the headphone volume.

NOTE

- To prevent hearing loss, do not raise the volume level excessively when using headphones.

10 BACK button

Returns to the previous item.

11 SOURCE button

This selects the input source. (👉 p. 33)



Rear panel

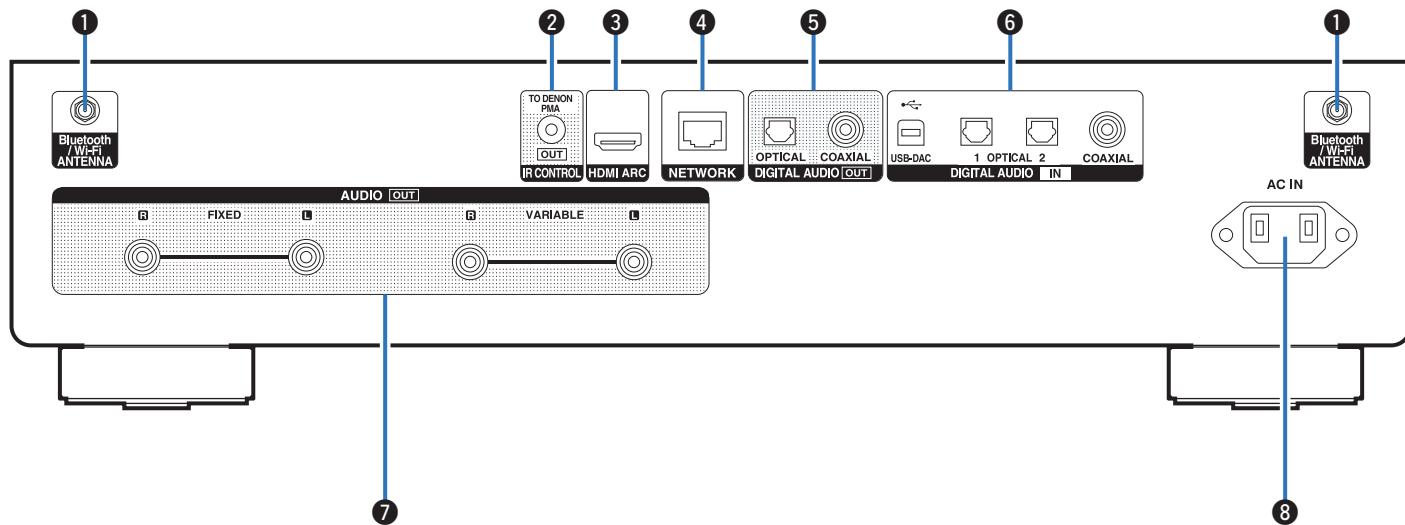

For details, see the next page.



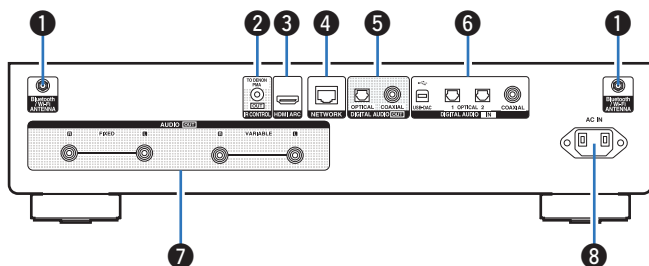

1 Bluetooth/wireless LAN antenna connectors

Used to connect the included external antennas for Bluetooth/wireless connectivity when connecting to a network via wireless LAN, or when connecting to a handheld device via Bluetooth. (☞ p. 28)

- ① Place the external antennas for Bluetooth/wireless connectivity evenly over the screw terminal of rear.
- ② Turn clockwise until the antennas is fully connected.
- ③ Rotate the antenna upwards for best reception.

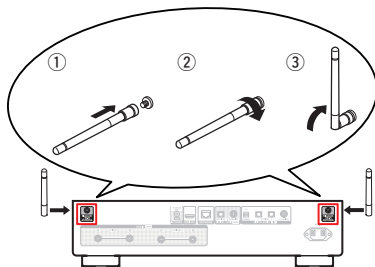

2 IR CONTROL connector

Connects to a Denon amplifier that is equipped with a IR CONTROL connector. (☞ p. 29)

3 HDMI connector (HDMI ARC)

Used to connect an ARC function-compatible TV. (☞ p. 19)

4 NETWORK connector

Used to connect to a LAN cable when connecting to a wired LAN network. (☞ p. 27)

5 DIGITAL AUDIO OUT connectors

Used to connect an amplifier or D/A converter that has a digital input connectors. (☞ p. 23)

6 DIGITAL AUDIO IN connectors

- Used to connect a TV with an optical or coaxial digital terminal. (☞ p. 21)
- Used to connect devices equipped with digital audio output connectors. (☞ p. 24)

7 AUDIO OUT connectors

Used to connect devices equipped with analog audio inputs connectors or an external power amplifier. (☞ p. 18)

8 AC inlet (AC IN)

Used to connect the power cord. (☞ p. 30)



Remote control unit

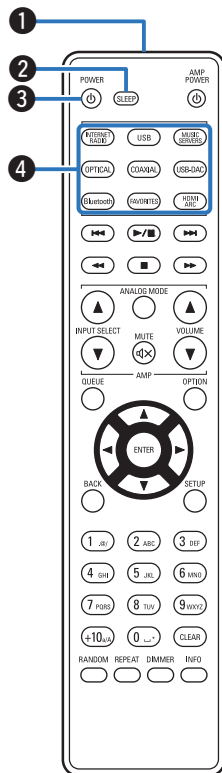

The remote control provided with this unit can control a Denon integrated amplifier.

- “Amplifier operations” (👉 p. 16)

■ Operating this unit

1 Remote control signal transmitter

This transmits signals from the remote control unit. (👉 p. 7)

2 SLEEP button

This sets the sleep timer. (👉 p. 73)

3 Power (POWER) button

This turns the power on/off (standby). (👉 p. 32)

4 Input source select buttons

These select the input source. (👉 p. 33)



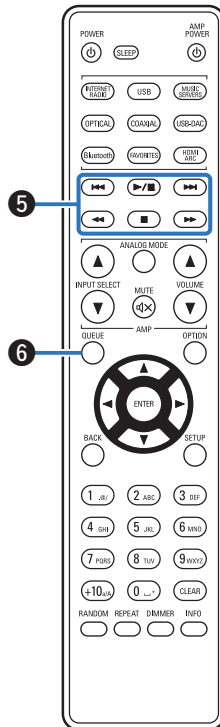

5 System buttons

These perform playback related operations.

- Play/Pause button (▶/⏸)
Press this button to pause during playback. If pressed while paused or stopped, resumes playback from the last track played.
- Forward-skip button (▶▶)
Press this button during playback to play the next track.
- Reverse-skip button (◀◀)
Press this button during playback to restart the current track or play the previous track.
- Fast-forward button (▶▶▶)
Press and hold this button to fast-forward the track.
- Fast-reverse button (◀◀◀)
Press and hold this button to fast-reverse the track.
- Stop button (■)
Press this button to stop during playback.



- Depending on the input source and online service, the operation cannot be performed.

6 QUEUE button

This displays the queue.

- “Listening to Internet Radio” (🔗 p. 34)
- “Playing back files stored on PC or NAS” (🔗 p. 36)
- “Playing a USB flash drive” (🔗 p. 39)



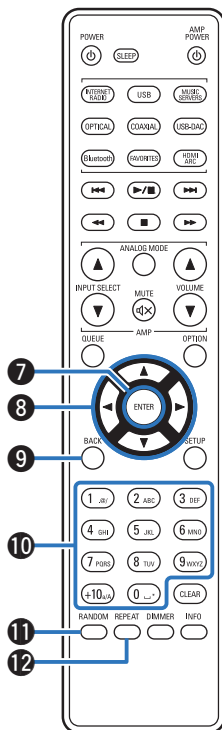

7 ENTER button

This determines the selection.

8 Cursor buttons (Δ ∇ \triangleleft \triangleright)

These select items.

9 BACK button

Returns to the previous item.

10 Number/letter buttons (0 – 9, +10)

These enter letters or numbers into the unit. (👉 p. 80)

11 RANDOM button

Switches the random playback.

12 REPEAT button

Switches the repeat playback.



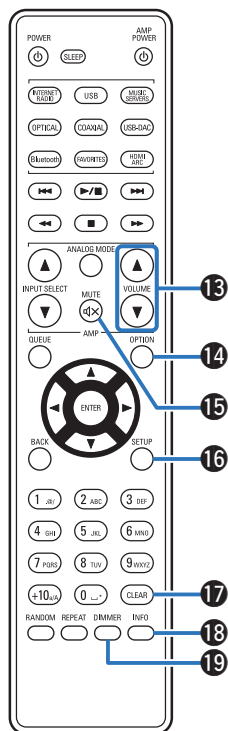

13 VOLUME buttons (▲▼)

These adjust the volume of the audio signal output from the analog audio output terminals (VARIABLE) of this unit. This function is enabled when the volume control mode of the remote control is network audio player control mode. (☞ p. 100)

14 OPTION button

This displays the option menu on the display.



- An option menu is not displayed for some input sources.

15 MUTE button (M)

This mutes the audio signal output from the analog audio output terminals (VARIABLE) of this unit. This function is enabled when the volume control mode of the remote control is network audio player control mode. (☞ p. 100)

16 SETUP button

The setting menu is displayed on the display. (☞ p. 79)

17 CLEAR button

This cancels the settings.

18 Information button (INFO)

This switches the track information shown in the display during playback.

19 DIMMER button

Adjust the display brightness of this unit. (☞ p. 73)



■ Amplifier operations

A Denon amplifier can be operated.

- ① INPUT SELECT buttons (▲▼)
- ② MUTE button (M)
- ③ Power (AMP POWER ⏻) button
- ④ ANALOG MODE button
- ⑤ VOLUME buttons (▲▼)



- The remote control may not operate some products.
- ② and ⑤ can be operated when the remote control operation mode is set to amplifier operation mode (factory default setting). (👉 p. 100)

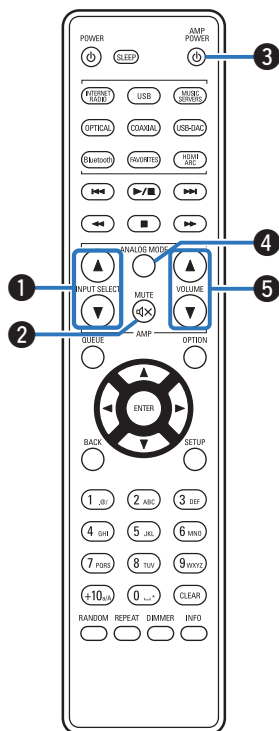

■ Contents







Connecting an amplifier	18
Connecting a TV	19
Connecting to a device with digital audio input connectors	23
Connecting to a device with digital audio output connectors	24
Connecting a PC or Mac	25
Connecting a USB flash drive to the USB port	26
Connecting to a home network (LAN)	27
Connecting to the IR control connector	29
Connecting the power cord	30

NOTE

- Do not plug in the power cord until all connections have been completed.
- Do not bundle power cords with connection cables. Doing so can result in humming or noise.

■ Cables used for connections

Provide necessary cables according to the devices you want to connect.

Audio cable (supplied)	
IR control cable (supplied)	
HDMI cable (not supplied)	
Optical cable (not supplied)	
Coaxial digital cable (not supplied)	
USB cable (not supplied)	
LAN cable (not supplied)	



Connecting an amplifier

In addition to the normal analog audio output connectors (FIXED) this unit has analog audio output connectors (VARIABLE) that allow you to adjust the volume of the audio signal output from this unit. Connect the power amplifier to the analog audio output connectors (VARIABLE) and press the VOLUME ▲▼ buttons on the remote control to adjust the volume of the audio signal output from this unit.

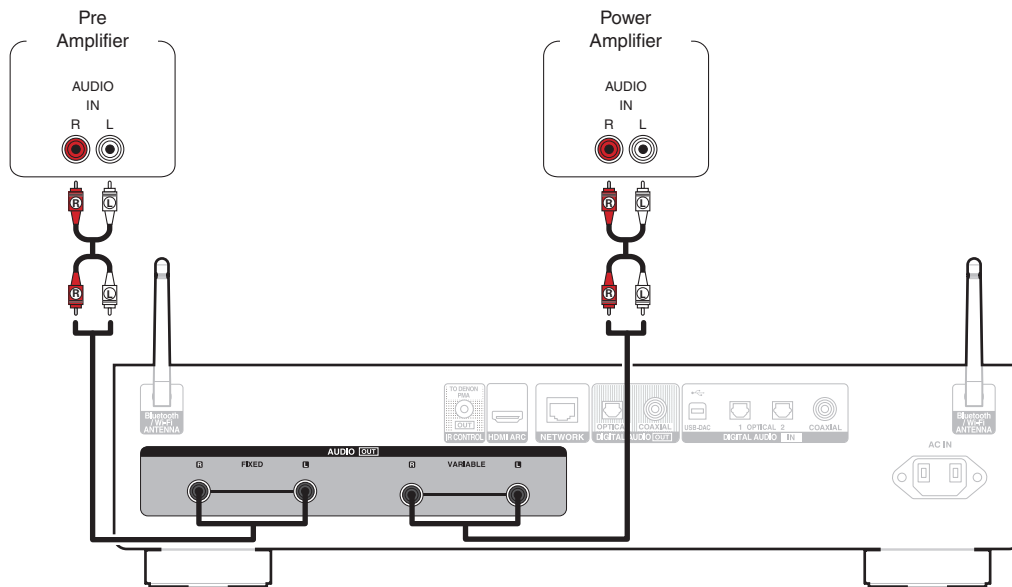

NOTE

- Do not connect a power amplifier to the analog audio output connectors (FIXED). Connecting a power amplifier may cause damage to the speakers.
- In the settings menu, set the audio output terminal for "Line Out Level" to "Variable" or "Fixed". (☞ p. 82)
- To adjust the volume of the audio signal output from the analog audio output connectors (VARIABLE) of this unit using the remote control, set the remote control operation mode of the volume buttons to network audio player operation mode. (☞ p. 100)
- While using HDMI ARC for TV connection it is highly recommended for the best volume control experience to use the variable output from this unit to connect to the amplifier.



Connecting a TV

This unit can be connected to a TV for high-quality playback of the TV audio.

Connecting this unit to the HDMI ARC terminal on a TV

If the HDMI terminal on your TV supports ARC, connect with HDMI.

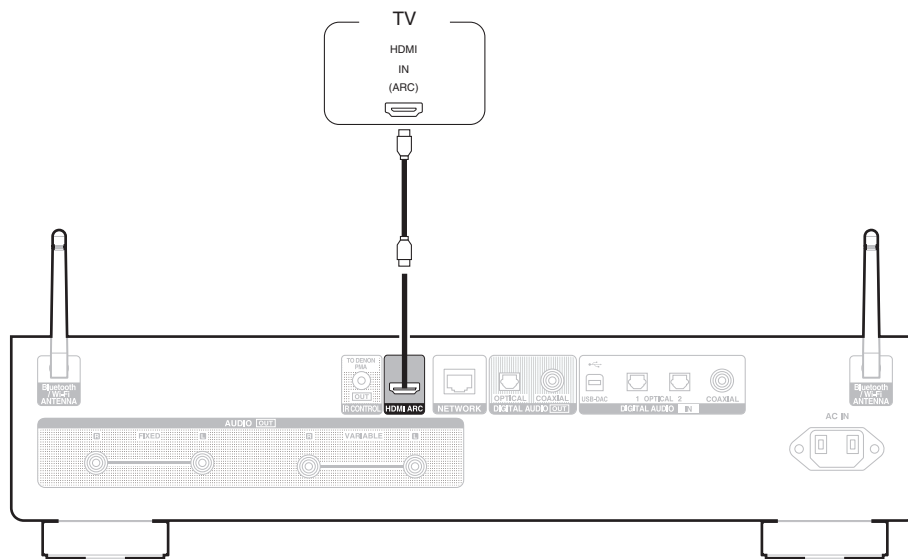



- When connecting a TV to this unit, turn off the audio output of the TV's internal speakers. See the owner's manual of your TV for details.
- When connecting the HDMI ARC terminal of this device to your TV, connect it to the HDMI input terminal of your TV that supports the ARC function.
- When connecting to a TV that does not support the ARC function, use an Optical connection or a Coaxial connection to play the TV audio. (👉 p. 21)
- While using HDMI ARC for TV connection it is highly recommended for the best volume control experience to use the variable output from this unit to connect to the amplifier. (👉 p. 18)

NOTE

- Only the PCM 2-channel setting can be used to play sound from a TV via the HDMI ARC function. Set "PCM 2ch" as the audio format in the TV settings.
- Linear PCM signals with a sampling frequency of 32 kHz, 44.1 kHz, 48 kHz, 88.2 kHz, 96 kHz, 176.4 kHz, or 192 kHz can be input into this unit.
- Do not input non-PCM signals, such as Dolby Digital, DTS and AAC. This causes noise and could damage the speakers.

■ Specifications of supported audio formats

See "D/A converter" (👉 p. 124).



Connecting this unit to the Optical or Coaxial terminal on a TV

If the HDMI terminal on your TV does not support ARC or your TV does not have any HDMI terminals, connect with an optical cable or a coaxial digital cable.

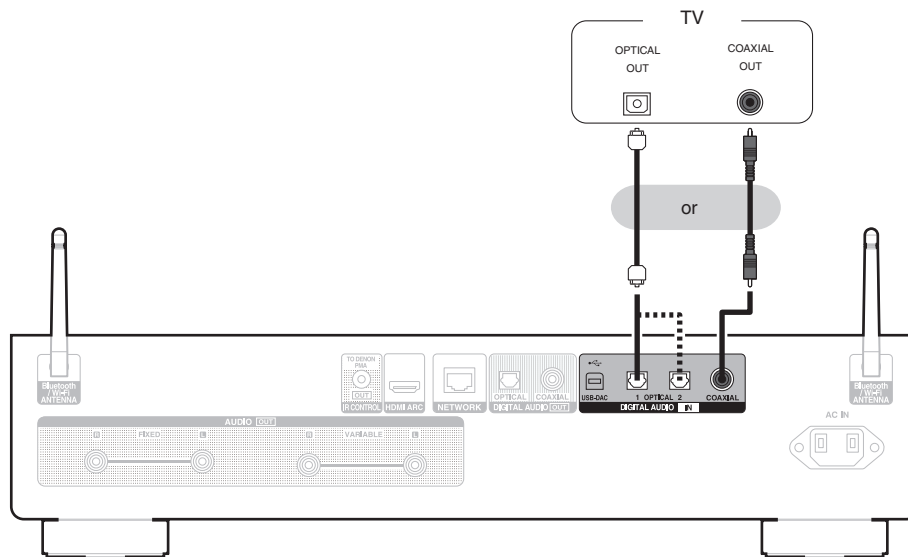



- When connecting a TV to this unit, turn off the audio output of the TV's internal speakers. See the owner's manual of your TV for details.

NOTE

- Linear PCM signals with a sampling frequency of 32 kHz, 44.1 kHz, 48 kHz, 88.2 kHz, 96 kHz, 176.4 kHz, or 192 kHz can be input into this unit.
- Do not input non-PCM signals, such as Dolby Digital, DTS and AAC. This causes noise and could damage the speakers.

■ Specifications of supported audio formats

See "D/A converter" (👉 p. 124).



Connecting to a device with digital audio input connectors

You can enjoy digital audio playback by connecting an amplifier or D/A converter that has a digital audio connector to this unit.

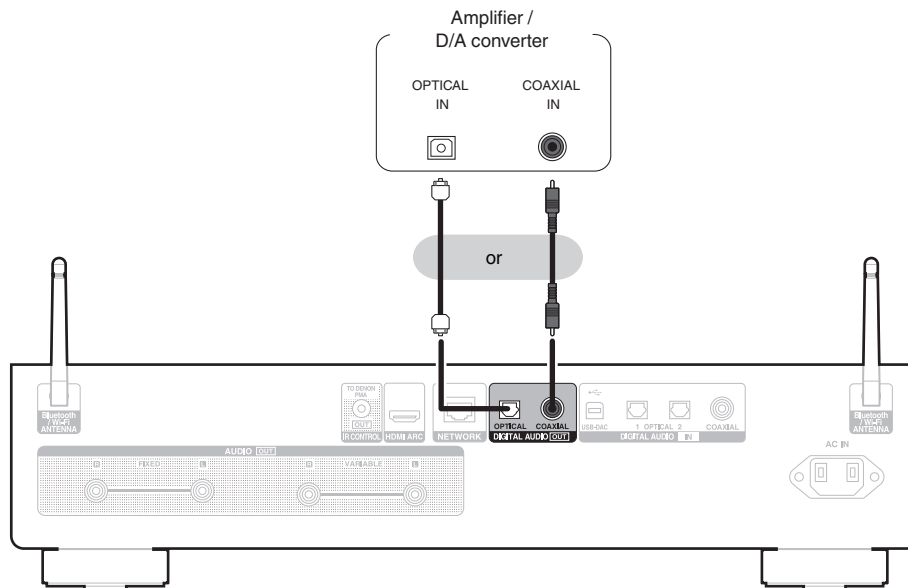

NOTE

- Digital audio output stops during playback of the DSD signals and linear PCM signals with a sampling frequency of 352.8/384 kHz using this unit's USB-DAC.
- Digital audio output stops during playback of the DSD files via USB and networks.



Connecting to a device with digital audio output connectors

Use this connection to input digital audio signals to this unit, and convert the signals for playback using the D/A converter of this unit. (🔗 p. 46)

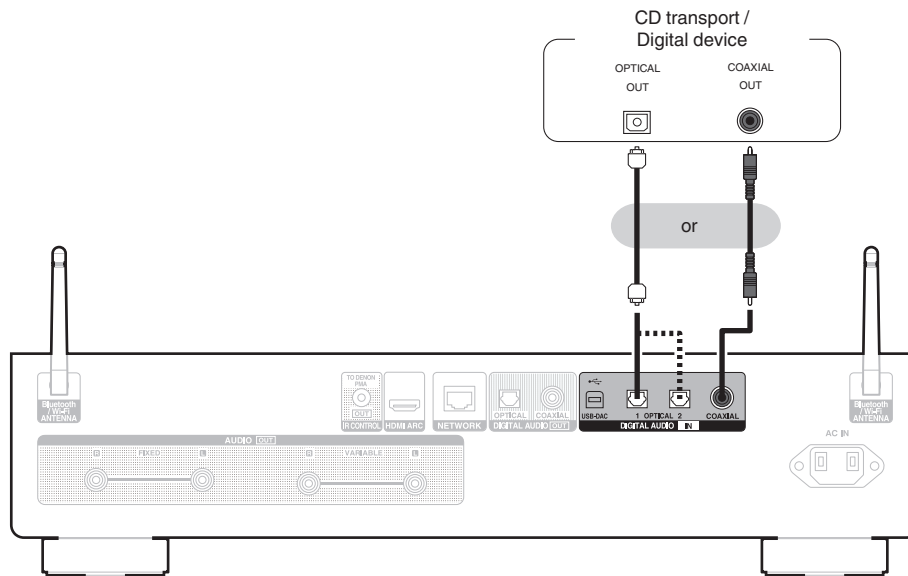

■ Specifications of supported audio formats

See “D/A converter” (🔗 p. 124).



Connecting a PC or Mac

By connecting a computer to the USB-DAC port on the rear panel of this unit using a commercially available USB connecting cable, this unit can be used as a D/A converter. (👉 p. 48)

NOTE

- Before USB connecting this unit to your computer, install the driver software in your computer. (👉 p. 48)
- Download the driver software from the DNP-200NE page of the Denon website.
- Use a cable that is 3 m or less to connect to the computer.

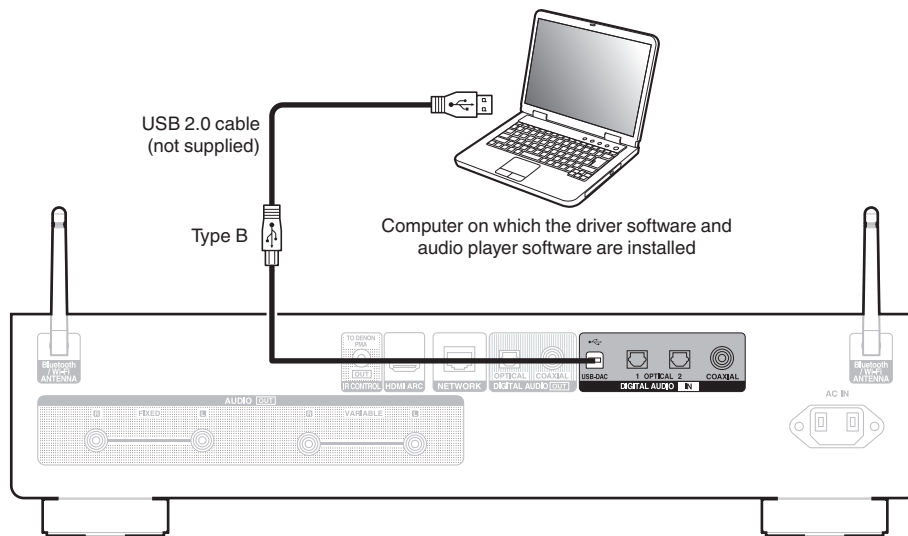

Connecting a USB flash drive to the USB port

For operating instructions see “Playing a USB flash drive” (🔗 p. 39).

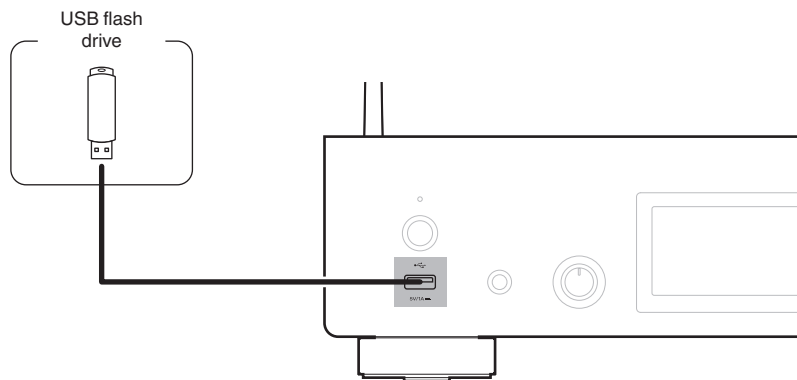

- Denon does not guarantee that all USB flash drives will operate or receive power. When using a portable USB hard disk drive (HDD) which came with an AC adapter, use that device's supplied AC adapter.

NOTE

- USB flash drives will not work via a USB hub.
- It is not possible to use this unit by connecting the unit's USB port to a PC via a USB cable. Connection to a computer is possible via the digital input USB-DAC port (Type B) on the rear panel.
- Do not use an extension cable when connecting a USB flash drive. This may cause radio interference with other devices.



Connecting to a home network (LAN)

This unit can connect to a network using a wired LAN or wireless LAN.

You can connect this unit to your home network (LAN) to enable various types of playback and operations as described below.

- Playback of network audio such as Internet Radio and from your media server(s)
- Playback of streaming music services
- Using the Apple AirPlay function
- Operation on this unit via the network
- Operation with the HEOS wireless multi-room sound system
- Firmware Update

For connections to the Internet, contact an ISP (Internet Service Provider) or a computer shop.

Wired LAN

To make connections via wired LAN, use a LAN cable to connect the router to this unit as shown in the figure below.

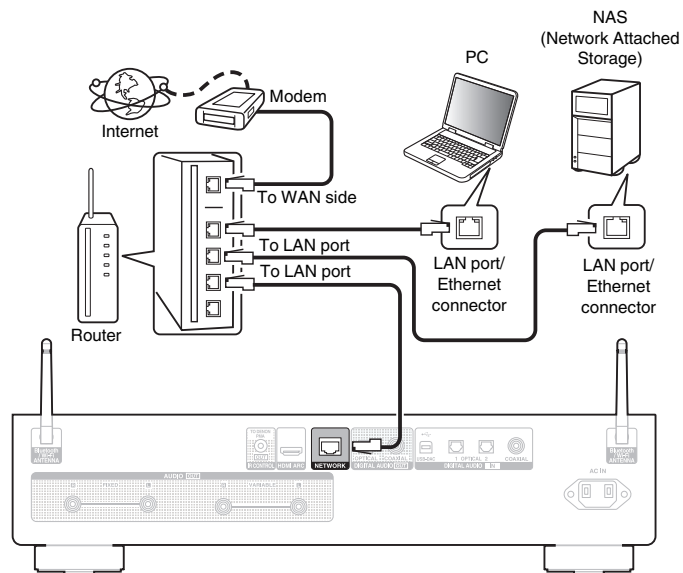

Wireless LAN

When connecting to the network via wireless LAN, connect the external antennas for Bluetooth/wireless connectivity connection to the rear panel and stand them upright.

See “Wi-Fi Setup” on how to connect to a wireless LAN router.

(☞ p. 94)

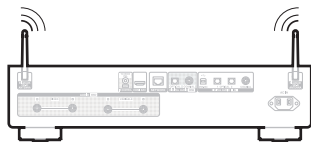
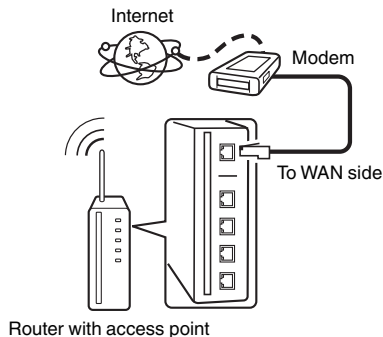

- When using this unit, we recommend you use a router equipped with the following functions:
 - Built-in DHCP server
This function automatically assigns IP addresses on the LAN.
 - Built-in 100BASE-TX switch
When connecting multiple devices, we recommend a switching hub with a speed of 100 Mbps or greater.
- Only use a shielded STP or ScTP LAN cable (readily available at electronics stores). (CAT-5 or greater recommended)
- The normal shielded-type LAN cable is recommended. If a flat-type cable or unshielded-type cable is used, other devices could be affected by noise.
- When using this unit connected to a network with no DHCP function, configure the IP address, etc. in “Network”. (☞ p. 92)

NOTE

- The types of routers that can be used depend on the ISP. Contact your ISP or a computer shop for details.
- This unit is not compatible with PPPoE. A PPPoE compatible router is required if your contracted line is not set using PPPoE.
- Do not connect a NETWORK connector directly to the LAN port/ Ethernet connector on your computer.
- Various online services may be discontinued without prior notice.
- Do not carry this unit by the antenna.



Connecting to the IR control connector

The following functions can be used when this unit is connected to a Denon amplifier.

- Controlling the amplifier through this unit using the HEOS app.
- Controlling the amplifier through this unit, using the TV remote control (HDMI control function).
- When this unit is turned on using the HEOS app or TV remote control (HDMI control function), the amplifier turns on and the input source of the amplifier switches to "EXT.PRE" or "NETWORK."



- When "Line Out Level" is set to "Variable" in the setting menu, the amplifier input source will switch to "EXT.PRE". When "Fixed" is set, the amplifier input source will switch to "NETWORK" (NETWORK/AUX). (👉 p. 82)
- When "Power On Link" is set to "Off" in the setting menu, the amplifier power will not turn on automatically even when this unit is turned on. (👉 p. 87)

■ Connection

Use the supplied IR control cable to connect the IR CONTROL OUT connector of this unit to IR CONTROL IN connector of the amplifier.



- Only the Denon amplifier which are equipped rear panel with IR CONTROL or REMOTE CONTROL connector can be connected.
- It may not be possible to control the volume with the TV remote control (HDMI control function) depending on the Denon amplifier and TV connected to this unit.

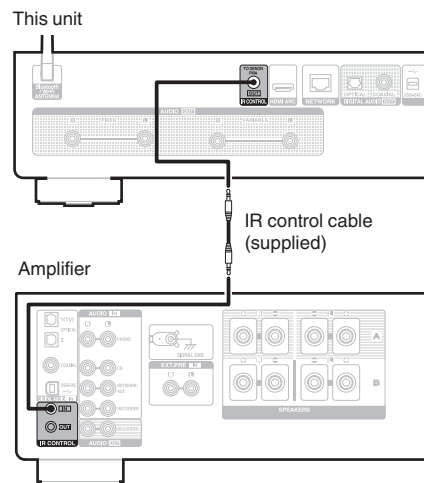

Connecting the power cord

After completing all the connections, insert the power plug into the power outlet.

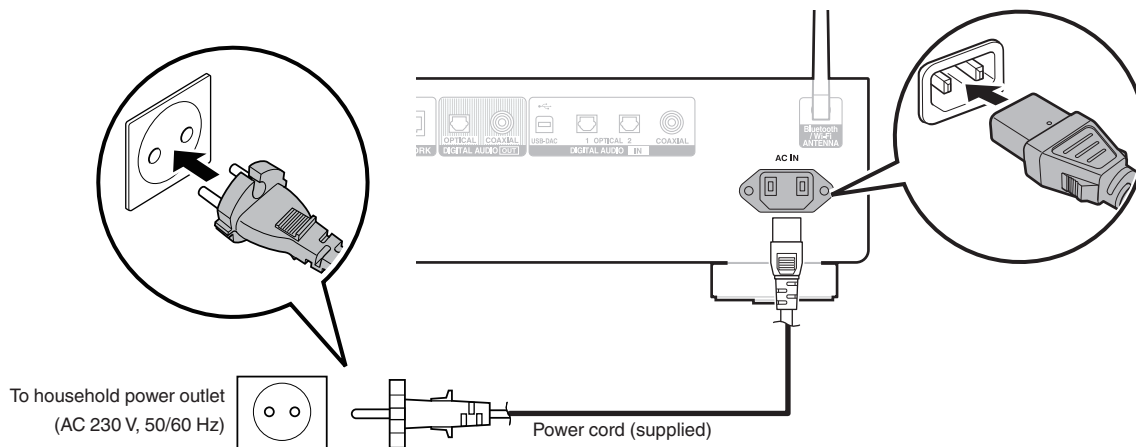

■ Contents

Basic operation

Turning the power on	32
Switching the power to standby	32
Selecting the input source	33

Playback network audio/service

Listening to Internet Radio	34
Playing back files stored on PC or NAS	36
Getting the HEOS app	58
AirPlay function	67
Spotify Connect function	70

Playback a device

Playing a USB flash drive	39
Listening to music on a Bluetooth device	42
Playing digital input	46

Convenience functions

Adding to HEOS Favorites	71
Playing back HEOS Favorites	72
Deleting a HEOS Favorites	72
Switching the display's brightness	73
Using the sleep timer	73



Basic operation

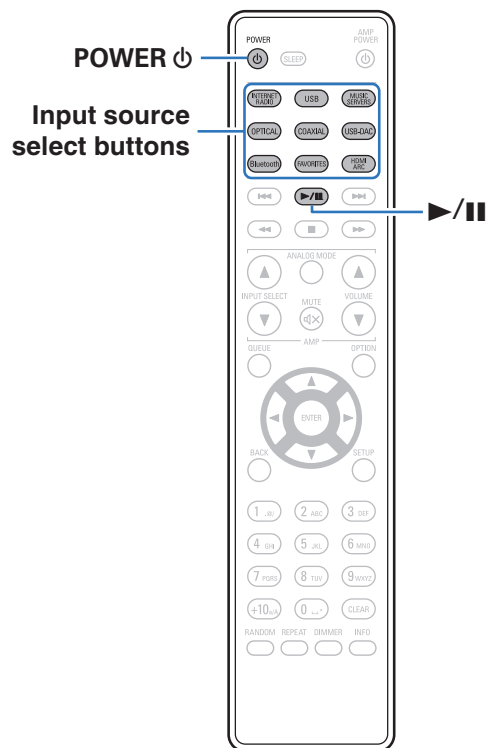

Turning the power on

1 Press **POWER** to turn on.



- You can also press on the main unit to turn on power from standby mode.
- You can also press to turn on power from standby mode.

Switching the power to standby

1 Press **POWER** .

The unit switches to standby mode.



- You can also switch the power to standby by pressing on the main unit.

NOTE

- Power continues to be supplied to some of the circuitry even when the power is in the standby mode. When leaving home for long periods of time or when going on vacation, unplug the power cord from the power outlet.



Selecting the input source

1 Press the input source select button to be played back.

The selected input source appears on the display.



- You can also select the input source by pressing SOURCE on the main unit.



Listening to Internet Radio

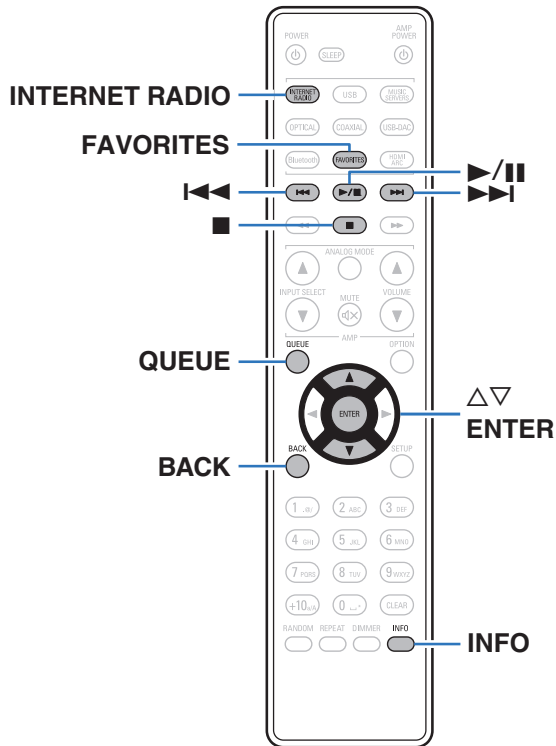





- Internet Radio refers to radio broadcasts distributed over the Internet. Internet Radio stations from around the world can be received.
- The Internet Radio station list on this unit the database service provided by TuneIn Radio service.
- The audio format types and specifications supported by this unit for playback are as follows.
See “Playing back Internet Radio” (📖 p. 127) for details.

- WMA
- MP3
- MPEG-4 AAC



Listening to Internet Radio

- 1 Press **INTERNET RADIO**.
- 2 Select the station you want to play.

Operation buttons	Function
 *	Playback / Pause
	Stop
 *	Skip to previous track / Skip to next track
	Select the item
ENTER	Enter the selected item / Playback
BACK	Moving up a level in the hierarchy
FAVORITES	The HEOS favorites list is displayed. ( p. 72)
INFO	Switching the radio station name and file format
QUEUE	This displays the queue

* Enabled when playing Podcasts.



- Any characters that cannot be displayed are replaced with "." (period).

NOTE

- The radio station database service may be suspended or be otherwise unavailable without notice.



Playing back files stored on PC or NAS

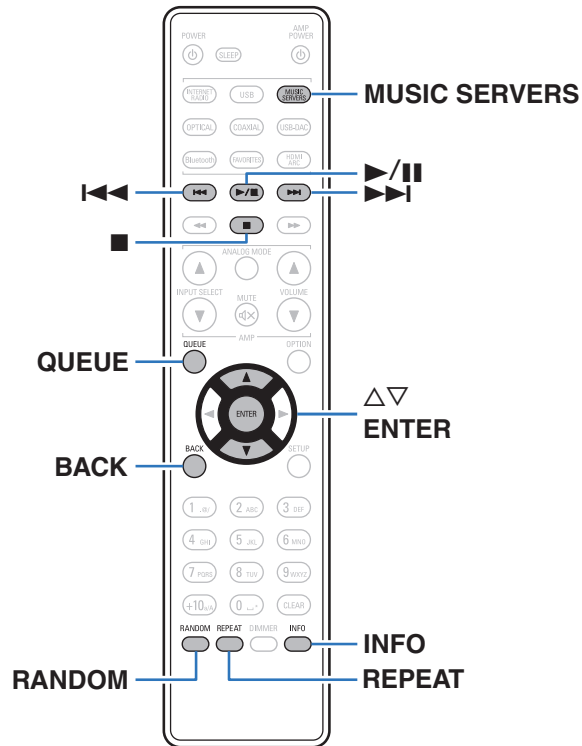

- This unit can playback music files and playlists (m3u, wpl) from DLNA compatible servers including PCs and NAS devices on your network.
- The audio format types and specifications supported by this unit for playback are as follows.
See “Playing back files stored on a PC and NAS” (📖 p. 126) for details.

- WMA
- MP3
- WAV
- MPEG-4 AAC
- FLAC
- Apple Lossless
- DSD



Playing back files stored on PC or NAS

Use this procedure to play music files or playlists stored on DLNA files servers on your local network.

- 1 Press MUSIC SERVERS to switch the input source to “Music Servers”.**
- 2 Select the name of your networked PC or NAS (Network Attached Storage) server.**

3 Browse the music on your PC/NAS and select something to play.



- When you select something to play you will be asked how you want to queue up your music.

Play Now:	Inserts the item into the queue after the currently playing track and plays the selected item immediately.
Play Now & Replace Queue:	Clears the queue and plays the selected item immediately.
Play Next:	Inserts the item into the queue after the current song and plays it when the current song ends.
Add to End of Queue:	Adds the item to the end of the queue.



4 Use Δ / ∇ to select the “Play Now” or “Play Now & Replace Queue”, then press ENTER.

Playback starts.

Operation buttons	Function
\blacktriangleright /	Playback / Pause
■	Stop
\blacktriangleleft \blacktriangleleft \blacktriangleright \blacktriangleright	Skip to previous track / Skip to next track
Δ ∇	Select the item
ENTER	Enter the selected item
BACK	Moving up a level in the hierarchy
REPEAT	Repeat playback <ul style="list-style-type: none"> Switching between Single-track repeat and All-track repeat
RANDOM	Random playback
INFO	Switching the album name and file format
QUEUE	This displays the queue

NOTE

- When playing back music files with your PC or NAS connected through wireless LAN, audio may be interrupted depending on your wireless LAN environment. In this case, connect using a wired LAN.
- The order in which the tracks/files are displayed depends on the server specifications. If the tracks/files are not displayed in alphabetical order due to the server specifications, searching by the first letter may not work properly.



Playing files stored on USB flash drives

- 1 Insert a USB flash drive into the front panel's USB port.
- 2 Press **USB** to switch the input source to "USB Music".
- 3 Select the name of this unit.

- 4 Browse the music on your USB flash drive and select something to play.



- When you select something to play you will be asked how you want to queue up your music.

Play Now:	Inserts the item into the queue after the currently playing track and plays the selected item immediately.
Play Now & Replace Queue:	Clears the queue and plays the selected item immediately.
Play Next:	Inserts the item into the queue after the current song and plays it when the current song ends.
Add to End of Queue:	Adds the item to the end of the queue.

- 5 Use Δ / ∇ to select the "Play Now" or "Play Now & Replace Queue", then press **ENTER**.

Playback starts.



Operation buttons	Function
▶/	Playback / Pause
■	Stop
◀◀▶▶	Skip to previous track / Skip to next track
△ ▽	Select the item
ENTER	Enter the selected item / Playback
BACK	Moving up a level in the hierarchy
REPEAT	Repeat playback <ul style="list-style-type: none"> Switching between Single-track repeat and All-track repeat
RANDOM	Random playback
INFO	Switching the album name and file format
QUEUE	This displays the queue

NOTE

- Note that Denon will accept no responsibility whatsoever for any problems arising with the data on a USB flash drive when using this unit in conjunction with the USB flash drive.
- When a USB flash drive is connected to this unit, the unit loads all of the files on the USB flash drive. Loading may take a while if the USB flash drive contains a large number of folders and/or files.



Listening to music on a Bluetooth device

In order to enjoy music from a Bluetooth device on this unit, the Bluetooth device must first be paired with this unit.

Once the Bluetooth device has been paired, it does not need to be paired again.

1 Prepare for playback.

- ① Connect the supplied external antennas for Bluetooth/wireless connectivity to the Bluetooth/wireless LAN antenna connectors on the rear panel. (☞ p. 11)
- ② Press POWER  to turn on power to the unit.

2 Press Bluetooth.

When playing content via Bluetooth on this unit for the first time, the unit will go into the pairing mode automatically and “Bluetooth Pairing Mode” will appear on the display of the unit.

3 Activate the Bluetooth settings on your Bluetooth device.



4 Select this unit when its name appears in the list of devices displayed on the screen of the Bluetooth device.

Connect to the Bluetooth device while “Bluetooth Pairing Mode” is being displayed on the display of the unit.

Perform the connection with the Bluetooth device close to the unit (about 1 m).

5 Play music using any app on your Bluetooth device.

- The Bluetooth device can also be operated with the remote control of this unit.
- The next time the Bluetooth button is pressed on the remote control unit, this unit automatically connects to the last Bluetooth device that was connected.

Operation buttons	Function
	Playback / Pause
	Skip to previous track / Skip to next track
INFO	Switching the Bluetooth device name and Album name.



Pairing with other Bluetooth devices

Pair a Bluetooth device with this unit.

- 1 Activate the Bluetooth settings on your Bluetooth device.**
- 2 Press and hold Bluetooth on the remote control unit for at least 3 seconds.**

This unit will go into the pairing mode.
- 3 Select this unit when its name appears in the list of devices displayed on the screen of the Bluetooth device.**



- This unit can be paired with a maximum of 8 Bluetooth devices. When a 9th Bluetooth device is paired, it will be registered in place of the oldest registered device.
- You can also enter pairing mode by pressing the OPTION button when the Bluetooth playback screen is displayed and selecting "Pairing Mode" from the displayed option menu.

NOTE

- To operate the Bluetooth device with the remote control of this unit, the Bluetooth device needs to support the AVRCP profile.
- The remote control of this unit is not guaranteed to work with all Bluetooth devices.
- For some Bluetooth devices, the volume set on the Bluetooth device is linked with that of the audio signal output from the analog audio output terminals (VARIABLE) of this unit.



Reconnecting to this unit from a Bluetooth device

After pairing is completed, the Bluetooth device can be connected without performing any operations on this unit.

This operation also needs to be performed when switching the Bluetooth device for playback.

- 1 If a Bluetooth device is currently connected, deactivate the Bluetooth setting of that device to disconnect it.**
- 2 Activate the Bluetooth setting of the Bluetooth device to be connected.**
- 3 Select this unit from the Bluetooth device list on your Bluetooth device.**
- 4 Play music using any app on your Bluetooth device.**



- When the power of this unit and the Bluetooth function of this unit are turned on, the input source will be automatically switched to “Bluetooth” if a Bluetooth device is connected.
- When the “Network Control” setting of this unit is set to “On” and a Bluetooth device is connected and is played with the unit in the standby state, the power of the unit will be turned on automatically. (🔗 p. 93)



Playing digital input

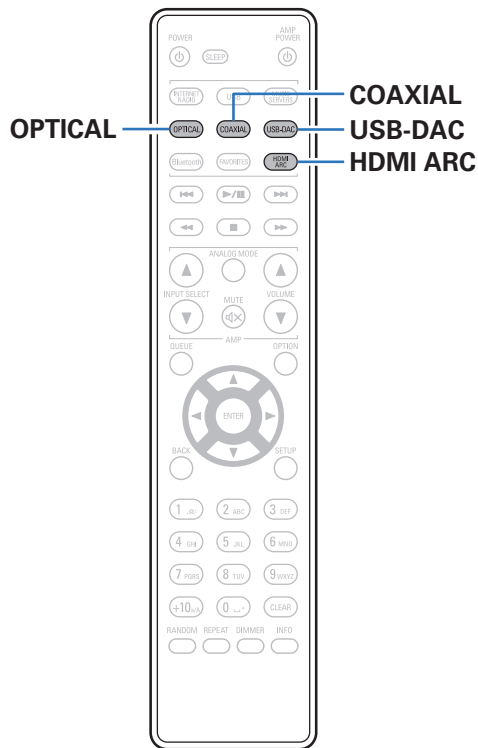

Connecting and playing back from a TV or digital device (HDMI ARC/Coaxial/Optical 1/Optical 2)

1 Prepare for playback.

Check the connection, then turn on this units. (“Connecting a TV” (👉 p. 19), “Connecting to a device with digital audio output connectors” (👉 p. 24))

2 Press HDMI ARC, COAXIAL or OPTICAL to switch the input source to “HDMI ARC”, “Coaxial”, “Optical 1” or “Optical 2”.

3 Play the component connected to this unit.

- If the sampling frequency cannot be detected, “Signal Unlock” will be displayed.
- “Unsupported” is displayed when audio signals that are not supported by this unit are input.





- When “TV Input” is set in the menu, this unit automatically turns on when the TV connected to the unit is turned on, and the input source switches to “HDMI ARC”, “Coaxial”, “Optical 1” or “Optical 2”. (🔍 p. 84)
- If you connect your TV via the Optical or Coaxial connection, this unit cannot be put to standby when you turn off your TV. If you want to automatically put this device on standby, set “Auto-Standby” in the settings menu. (🔍 p. 86)

NOTE

- Do not input non-PCM signals, such as Dolby Digital, DTS and AAC. This causes noise and could damage the speakers.
- Only the PCM 2-channel setting can be used to play sound from a TV via the ARC function. Set “PCM 2ch” as the audio format in the TV settings.

■ Specifications of supported audio formats

See “D/A converter” (🔍 p. 124).

■ HDMI control function

Connect this unit to a TV that supports the HDMI control function with an HDMI cable and enable the HDMI control setting on the TV to perform basic operations on this unit (changing the input source, turning the power on and off, adjusting the volume) with the remote control of the TV.

Refer to “About HDMI” (🔍 p. 128) for more information about the HDMI control function.



Connecting and playing back from a computer (USB-DAC)

You can enjoy high-quality audio playback from the D/A converter built in to this unit by inputting music files into this unit from a computer via USB connection.

- Before USB connecting this unit to your computer, install the driver software in your computer.
- Drivers do not need to be installed for macOS.
- Also, you can use whichever commercially available or downloadable player software you like to playback files on your computer.

■ Computer (system requirements)

OS

- Windows 10 or Windows 11
- macOS 12 or 13

USB

- USB 2.0: USB High speed/USB Audio Class Ver. 2.0

NOTE

- This unit was checked the operation using the system requirements by us, but it does not guarantee the operation of all systems.

- DSD is a registered trademark.
- Microsoft, Windows 10 and Windows 11 are either registered trademarks or trademarks of Microsoft Corporation in the United States and/or other countries.
- ASIO is a trademark of Steinberg Media Technologies GmbH.
- Apple, Macintosh and macOS are trademarks of Apple Inc., registered in the U.S. and other countries.

Windows OS Installing the dedicated driver (👉 p. 49)

macOS Audio Device Settings (👉 p. 55)



■ Installing the dedicated driver (Windows OS only)

□ Installing the driver software

- 1 Disconnect the USB cable between your PC and the unit.**
 - The driver software cannot be installed correctly if your PC is connected to the unit by a USB cable.
 - If the unit and your computer are connected by a USB cable and the computer is switched on before installation, disconnect the USB and restart the computer.
- 2 Download the dedicated driver from the “Download” section of the DNP-2000NE page of the Denon website onto your PC.**
- 3 Unzip the downloaded file, and double-click the exe file.**

4 Install the driver.

- ① Select the language to use for the installation.
- ② Click “OK”.

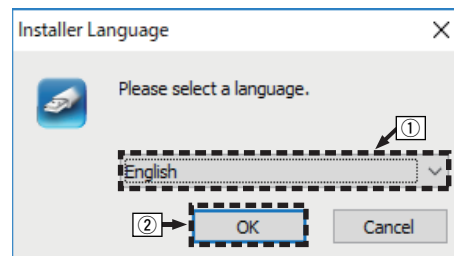

- ③ The wizard menu is displayed. Click “Next”.

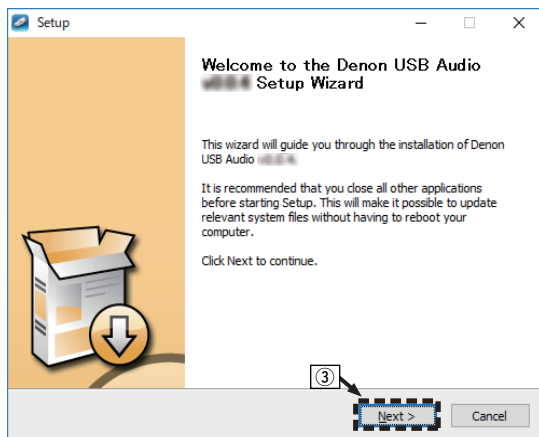

- ④ Read the Software Licensing Agreement, and click “I accept the terms of the License Agreement”.
- ⑤ Click “Next”.

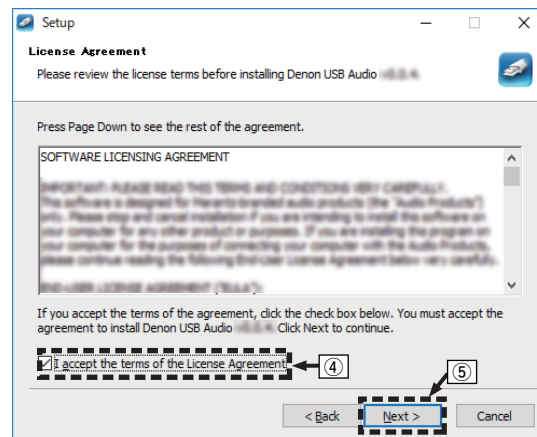

- ⑥ Click “Install” on the installation start dialog.
- The installation starts. Do not perform any operation on the PC until the installation is completed.

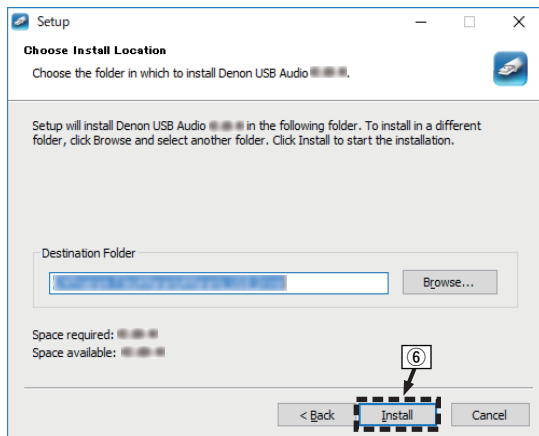

- ⑦ Click “Next”.

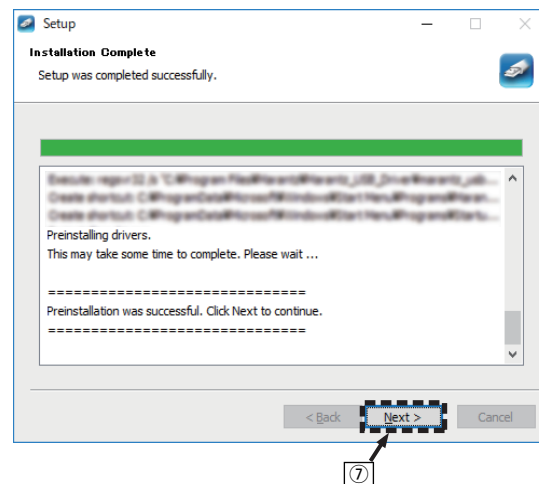

⑧ When the installation is completed, click “Finish”.

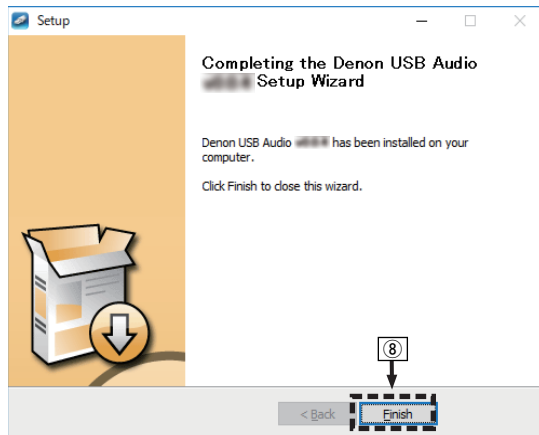

⑨ Click “Yes”.

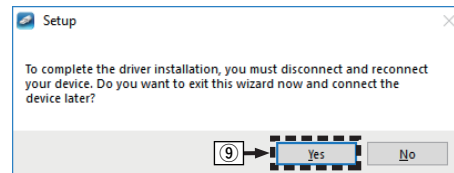

5 With the unit power off, connect the unit and PC using a USB cable (sold separately).

- For details on connections, see “Connecting a PC or Mac” (p. 25).



6 Press POWER .

- When the unit power is turned on, the PC automatically finds and connects to the unit.

7 Press USB-DAC to switch the input source to “USB-DAC”.

8 Checking the installed driver.

- ① Open the “Control Panel” on the PC.
 - The control panel setting list is displayed.
- ② Click “Sound”.
 - The sound menu window is displayed.
- ③ Check that there is a checkmark next to “Default Device” under in “DNP-2000NE” of the “Playback” tab.
 - When there is a checkmark for a different device, click “DNP-2000NE” and “Set Default”.

9 Checking audio output.

Outputs a TEST signal from the PC and checks the audio output from the USB-DAC function.

- ① Select “DNP-2000NE” and click “Properties”.
 - The Properties window is displayed.

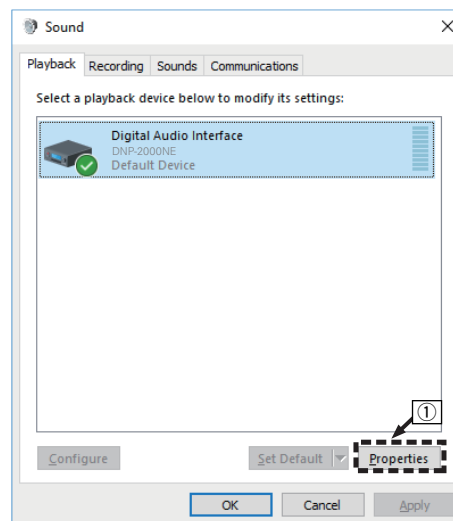

- ② Click the “Advanced” tab.
 - ③ Select the sampling rate and bit rate to be applied to the D/A converter.
 - It is recommended that “2 channel, 32 bit, 192000 Hz (Studio Quality)” is selected.
 - ④ Click “Apply”.
 - ⑤ Click “Test”.
- Check that audio from this unit is output from the PC.

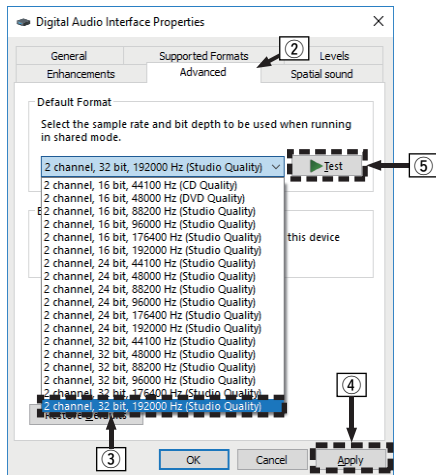

- The dedicated driver must be installed in the PC before this unit is connected to a PC. Operation will not occur correctly if connected to the PC before the dedicated driver has been installed.
- Operation may fail in some PC hardware and software configurations.
- Player software supporting the Audio Stream Input Output (ASIO) driver is required to play files with a sampling frequency of 352.8 kHz/384 kHz without downsampling. Check your player software before playing files with the ASIO driver.
- Please see the FAQ at www.denon.com if you experience any issues getting audio to play from your computer through this unit. You may also want to check the support pages for your audio player application.



■ Audio Device Settings (macOS only)

- ① With the unit power off, connect the unit and Mac using a USB cable (sold separately).
 - For the connection procedure, refer to the “Connecting a PC or Mac” section. (👉 p. 25)
- ② Press POWER \mathcal{P} .
- ③ Press USB-DAC to switch the input source to “USB-DAC”.
- ④ Move the cursor to “Go” on the computer screen, and then click “Utilities”.
 - The utility list is displayed.
- ⑤ Double-click “Audio MIDI Setup”.
 - The “Audio Devices” window is displayed.
- ⑥ Secondary click on “DNP-2000NE”, and then check that “Use This Device For Sound Output” is checked.
 - If a different device is checked, select and secondary click on “DNP-2000NE”, and then select “Use This Device For Sound Output”.

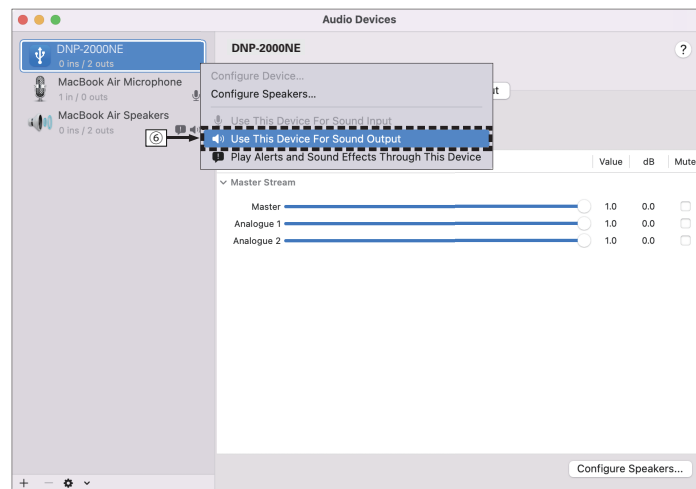

- ⑦ Select the “DNP-2000NE” format.
- It is normally recommended to set the format to “2 ch 32-bit Integer 384.0 kHz”.

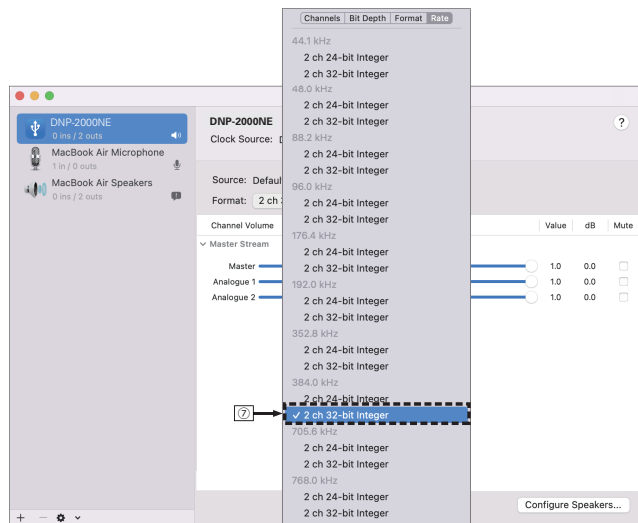

- ⑧ Quit Audio MIDI Setup.

■ Playback

Install the desired player software on your computer beforehand.
Use the rear panel USB-DAC port to connect this unit to a computer.
(☞ p. 25)

1 Press USB-DAC to switch the input source to “USB-DAC”.

Start playback on the computer’s player software.

- If the sampling frequency cannot be detected, “Signal Unlock” will be displayed.
- “Unsupported” is displayed when audio signals that are not supported by this unit are input.



■ Specifications of supported audio formats

See “D/A converter” (🔍 p. 124).



- Perform operations such as playback and pause on the computer. At this time, you cannot perform operations with buttons on this unit or the remote control.
- When this unit is functioning as a D/A converter, sound is not output from the computer's speakers.
- If the computer is disconnected from this unit while the computer music playback software is running, the playback software may freeze. Always exit the playback software before disconnecting the computer.
- When an error occurs on the computer, disconnect the USB cable and restart the computer.
- The sampling frequency of the music playback software and sampling frequency displayed on this unit may differ.
- Use a cable that is 3 m or less to connect to the computer.



Getting the HEOS app

You can use many online music streaming services from the HEOS app. Depending upon your geographical location, there are several options to choose from.

Download the HEOS app for iOS or Android by searching App Store, Google Play store or Amazon Appstore for “HEOS”.



- Specifications of the HEOS app may be changed without prior notice for improvement purposes.



HEOS Account

HEOS Accounts can be registered in “HEOS Account” (👉 p. 99) in the menu of this unit or by tapping “Music” tab - “Settings” icon ⚙️ in the HEOS app.

■ What is a HEOS Account?

A HEOS Account is master account or “keychain” for managing all of your HEOS music services with one single username and password.

■ Why do I need a HEOS Account?

With the HEOS Account you just have to enter your music services login names and passwords one time. This allows you to easily and quickly use multiple controller apps on different devices.

You just log into your HEOS Account on any device and you will have access to all of your associated music services, play history and custom playlists, even if you are at a friend’s house listening to music on their HEOS system.

■ Signing up for a HEOS Account

You will be instructed to signup for a HEOS Account the first time you try to access any music service from the main “Music” menu of the HEOS app. Follow the instructions in the HEOS app to complete the operation.

■ Changing your HEOS Account

- 1 Tap the “Music” tab.
- 2 Select the Settings icon ⚙️ in the upper left corner of the screen.
- 3 Select “HEOS Account”.
- 4 Change your location, change your password, delete your account or sign out of your account.



Playing from streaming music services

A music service is an online music company that provides access to vast music collections via free and/or paid subscriptions. Depending upon your geographical location, there are several options to choose from.

NOTE

- The HEOS app and brand is not affiliated with any manufacturer of any mobile device. Availability of music services may vary by region. Not all services may be available at time of purchase. Some services may be added or discontinued from time to time based on decisions of the music service providers or others.

■ Selecting a room/device

- 1 Tap the “Rooms” tab. Select “Denon DNP-2000NE” if there are multiple products with HEOS Built-in.



- Tap the Pencil icon  at the top right to switch edit mode. You can change the displayed name.

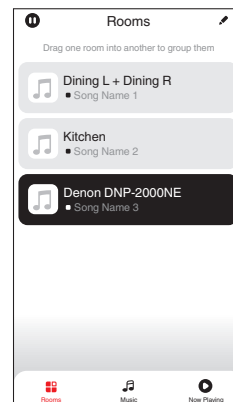

■ Selecting the music track or station from music sources

1 Tap the “Music” tab and select a music source.



- All music services displayed may not be available in your location.

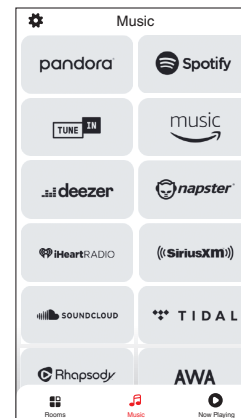

2 Browse the music to play.

After selecting a music track or radio station the app will automatically change to the “Now Playing” screen.



- When you select a music track to play you will be asked how you want to queue up your music.

Play Now:	Inserts the item into the queue after the currently playing track and plays the selected item immediately.
Play Now & Replace Queue:	Clears the queue and plays the selected item immediately.
Play Next:	Inserts the item into the queue after the current song and plays it when the current song ends.
Add to End of Queue:	Adds the item to the end of the queue.



- When you select a radio station the following items are displayed.

Play Now:	Plays the selected item immediately.
Add to HEOS Favorites:	Adds to HEOS Favorites.



- Set “Network Control” of the settings menu to “On” so that when you are playing back from the HEOS app while this device is in standby, this device turns on automatically. (“Network Control” (🔧 p. 93))

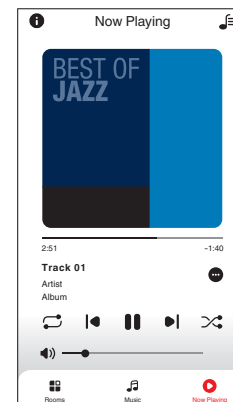
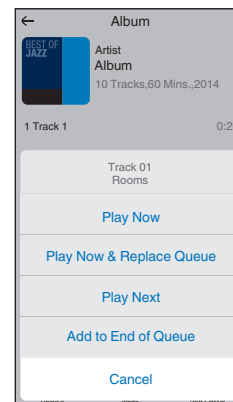

Listening to the same music in multiple rooms

This system is a true multi-room audio system. You can create one or more HEOS groups to automatically synchronize audio playback between multiple products with HEOS Built-in so that the music playing different rooms is perfectly in sync and always sounds amazing! You can easily add up to 32 products to your system in total. You can group up to 16 individual products to have them play the same song fully synchronized.

■ Grouping rooms

- 1** Press and hold your finger on room that is not playing music.
- 2** Drag it into the room that is playing music and lift your finger.
- 3** The two rooms will be grouped together into a single device group and both rooms will be playing the same music in perfect sync.

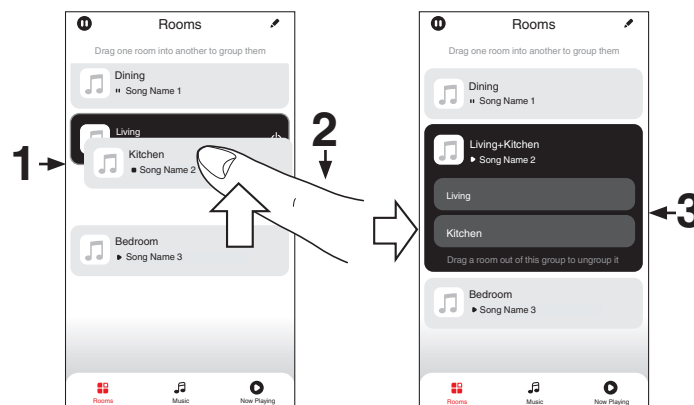

■ Ungrouping rooms

- 1** Press and hold your finger on room that you want to remove from the group.
- 2** Drag it out of the group and lift your finger.

NOTE

- You can not remove the first room that started playing the music before grouping.

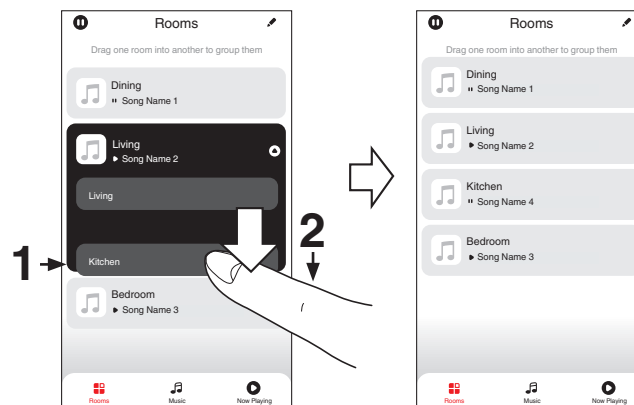

■ Grouping all rooms (party mode)

You can easily group 16 rooms together into Party Mode by using a “pinch” gesture.

- 1** Place two fingers on the screen over the list of rooms.
- 2** Quickly pinch your two fingers together and release.
- 3** All of your rooms will be joined together and begin playing the same music in perfect sync.

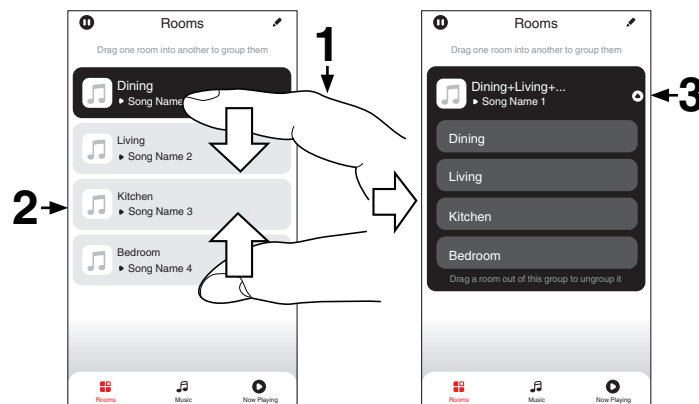

■ Ungrouping all rooms

You can easily ungroup all of your rooms and exit Party Mode by using a “spread” gesture.

- 1 Place two fingers close together on the screen over list of rooms.**
- 2 Quickly spread your two fingers apart from each other and release.**
- 3 All of your rooms will be ungrouped.**

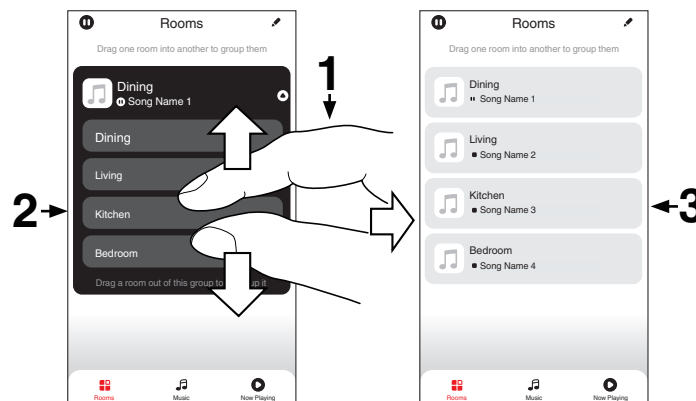

AirPlay function

Music files stored on your iPhone, iPod touch, iPad or iTunes can be played on this unit via the network.



- Input source will be switched to “AirPlay” when AirPlay playback is started.
- You can stop AirPlay playback by choosing other input source.
- For information about how to use iTunes, also see the Help for iTunes.
- The screen may differ depending on the OS and software versions.

NOTE

- In playback using the AirPlay function, the sound is output at the iPhone, iPod touch, iPad or iTunes volume setting level.
You should turn down the iPhone, iPod touch, iPad or iTunes volume prior to playback and then adjust it to a suitable level.

This unit supports AirPlay 2.

Sync multiple AirPlay 2 compatible devices/speakers for simultaneous playback.



- This unit supports AirPlay 2 and requires iOS 11.4 or later.

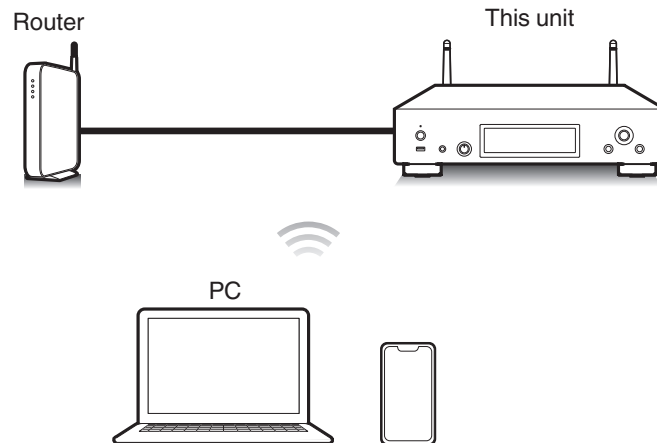

Playing songs from your iPhone, iPod touch or iPad

If you update your “iPhone/iPod touch/iPad” to iOS 10.0.2 or later, you can stream music stored in your “iPhone/iPod touch/iPad” directly to this unit.

1 Connect your iPhone, iPod touch or iPad Wi-Fi to the same network as this unit.

- For details, see your device’s manual.

2 Play the song on your iPhone, iPod touch or iPad.

AirPlay icon is displayed on the iPhone, iPod touch or iPad screen.

3 Tap the AirPlay icon and select this unit.

[Example] iOS 15

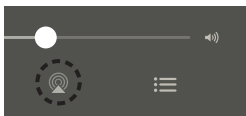

[Example] iOS 10



Playing iTunes music with this unit

1 Install iTunes 10, or later, on a Mac or Windows PC that is connected to the same network as this unit.

2 Start iTunes and click the AirPlay icon to select this unit.

[Example] iTunes



3 Choose a song and click play in iTunes.

The music will stream to this unit.



- When “Network Control” is set to “On”, you can turn on this unit by operating iTunes. (🔧 p. 93)



Play a song from your iPhone, iPod touch or iPad on multiple synced devices (AirPlay 2)

Songs from an iPhone, iPod touch or iPad operating iOS 11.4 or later can be synced with multiple AirPlay 2 supported devices for simultaneous playback.

1 Play the song on your iPhone, iPod touch or iPad.

AirPlay icon is displayed on the iPhone, iPod touch or iPad screen.

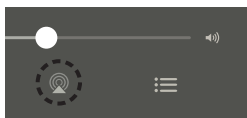

2 Tap the AirPlay icon and select this unit.

Displays a list of devices/speakers that can be played back on the same network.

- A circle is displayed to the right of AirPlay 2 compatible devices.

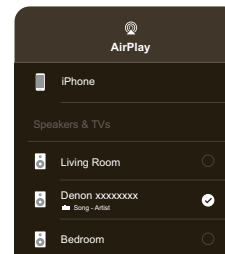

3 Tap the devices/speakers you want to use.

- Multiple AirPlay 2 compatible devices can be selected.

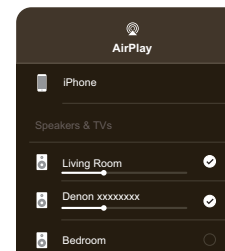

Spotify Connect function

Spotify is all the music you'll ever need. Millions of songs available instantly. Just search for the music you love, or let Spotify play you something great. Spotify works on your phone, tablet, computer and home speakers. So you'll always have the perfect soundtrack for whatever you're doing. Now you can enjoy Spotify with your free account as well as Premium account.

Use your phone, tablet or computer as a remote control for Spotify.

Go to www.spotify.com/connect to learn how.

The Spotify software is subject to third party licenses found here:

www.spotify.com/connect/third-party-licenses

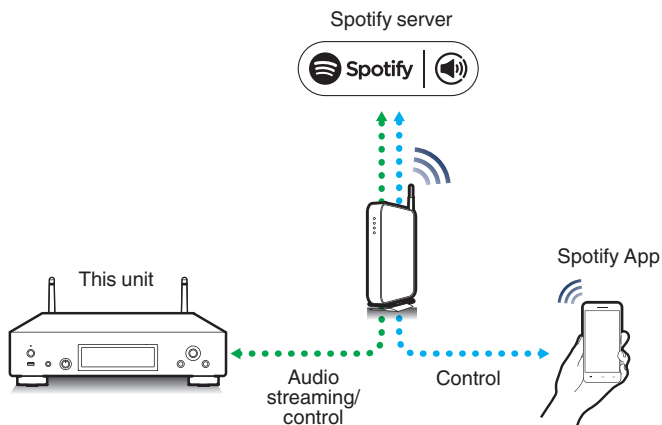

Playing Spotify music with this unit

Download the "Spotify App" onto your iOS or Android device beforehand.

- 1 Connect the Wi-Fi settings of the iOS or Android device in the same network as this unit.**
- 2 Launch the Spotify App.**
- 3 Play back the Spotify track.**
- 4 Tap the Spotify icon  to select the unit.**
The music will stream to this unit.



Convenience functions

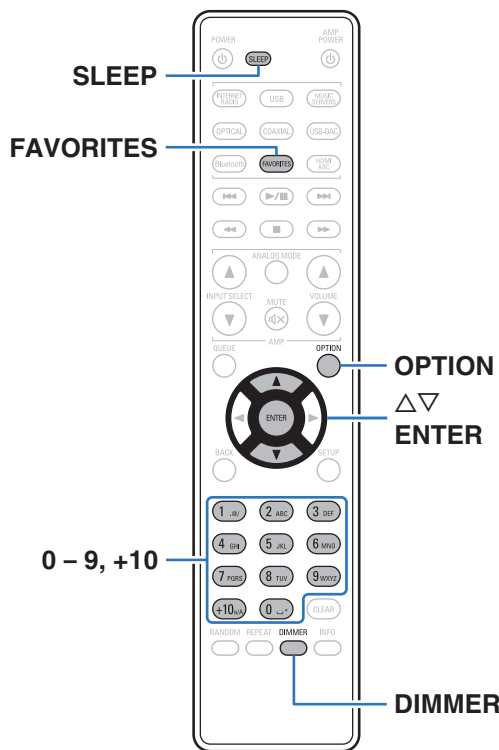

- This section explains how to use convenient functions that can be used for each input source.
- Control of “HEOS Favorites” operations is optimized for the app. For more information on acquiring the app, see “Getting the HEOS app” (📖 p. 58).

Adding to HEOS Favorites

This function only works for streamed content.

- 1 While content is playing, press OPTION.**
The option menu is displayed.
- 2 Use $\Delta \nabla$ to select “Add to HEOS Favorites”, then press ENTER.**
- 3 Use $\Delta \nabla$ to select the “HEOS Favorites” number you would like to save your contents to, then press ENTER.**



Playing back HEOS Favorites

- 1 Press FAVORITES.**
The “HEOS Favorites” is displayed.
- 2 Use $\Delta\nabla$ to select the content you would like to playback, then press ENTER.**
- 3 Use $\Delta\nabla$ to select “Play Now”, then press ENTER.**



- You can select content you would like to playback from your HEOS Favorites by pressing 0-9 and +10.

Deleting a HEOS Favorites

- 1 Press FAVORITES.**
The “HEOS Favorites” is displayed.
- 2 While the HEOS Favorites content list is displayed, use $\Delta\nabla$ to select the item you want to remove from HEOS Favorites, then press ENTER.**
- 3 Use $\Delta\nabla$ to select “Remove from HEOS Favorites”, then press ENTER.**



Switching the display's brightness

The display brightness can be adjusted between four levels. Switching the display off reduces a source of noise that affects sound quality, enabling higher sound quality playback.

1 Press DIMMER.

- The brightness of the display switches each time the button is pressed.



- If the buttons are operated when the display is turned off, information is displayed temporarily.
- The display brightness is set to most brightly by default.

Using the sleep timer

You can have the power automatically switched to standby once a set time has elapsed. This is convenient for listening while going to sleep.

1 Press SLEEP during playback and select the setting time.

- The sleep timer can be set to up to 90 minutes, in steps of 10 minutes.
- After about 5 seconds, the setting is entered and the display returns to as it was before.

■ To cancel the sleep timer

1 Press SLEEP to set "Sleep ► Off".



- The sleep timer setting is canceled when the unit switches to standby mode.
- To check the time remaining until the sleep timer is activated, press SLEEP.



Menu map

For menu operations, see the following page.

By default, this unit has recommended settings defined. You can customize this unit based on your existing system and your preferences.

Setting items	Detailed items	Description	Page
Audio	Line Out Level	Set according to the terminal (VARIABLE or FIXED) where the amplifier is connected.	82
	Volume Limit	Make a setting for the maximum volume of the audio signal output from the analog audio output terminals (VARIABLE).	82
	H/P Amplifier Gain	Set the gain of the headphone amplifier. By setting according to the impedance of your headphone, you can enjoy playing headphones at an appropriate volume.	83
TV	TV Input	Set this when playing audio from a TV on this unit.	84
	HDMI Power Off Control	Set the "HDMI Power Off Control" function that is keyed to the power off operation of your TV to turn the device's power to standby.	85



Setting items	Detailed items	Description/Detailed items	Page
General	Language	Sets the language for display the menu.	86
	Auto-Standby	Sets the unit power to standby when the unit is not in use.	86
	Power On Link	Sets the “Power On Link” function, which links the powering on of Denon amplifiers connected to this unit to the powering on of this unit, turning them on when power on operations are performed on this unit.	87
	Usage Data	Selects whether or not to send anonymous usage data to Denon.	87
	Firmware	Set whether or not to check for firmware update, update the firmware, and display update and upgrade notifications.	88
		Check for Update	88
		Auto-Update	88
		Allow Update	89
		Upgrade Notification	89
		Add New Feature	90
	Information	Displays notifications. Also, sets whether or not to display the notification when the power is turned on.	91
		Notification Alerts	91
		Check for Notifications	91
	Reset	Various settings are reset to the factory default values.	91



Setting items	Detailed items	Description/Detailed items	Page	
Network	Network Information	Displays various information about the network.	92	
	Network & USB-A	The network and USB memory playback (USB-A) functions can be stopped to prevent noise that affects the sound quality.	92	
	Wi-Fi	The Wi-Fi function can be stopped to prevent noise that affects the sound quality.	92	
	Bluetooth	Stopping Bluetooth function reduces a source of noise that affects sound quality, enabling higher sound quality playback.	92	
	Network Control	Performs the on/off settings for the network function when in standby mode.	93	
	Friendly Name	Edits a name displayed on the Internet.	93	
	Connection	Choose whether to connect the home network to a wireless LAN or a wired LAN.	94	
		Wi-Fi	Use the wireless LAN (Wi-Fi) function to connect to a network.	94
		Auto-Scan		94
		Share Wi-Fi setting from an iOS device		95
		WPS Router		95
	Manual		96	
	Wired	Use a LAN cable to connect to a network.	94	



Setting items	Detailed items	Description/Detailed items	Page
Network	Settings	Used for manually setting the IP address.	97
		DHCP	97
		IP Address * 1	97
		Subnet Mask * 1	97
		Gateway * 1	97
		DNS * 1	97
		Save	97
	Diagnostics	Used to check the network connection.	98
		Physical Connection * 2	98
		Router Access	98
		Internet Access	98
	AirPlay	Settings for Apple AirPlay.	98
		AirPlay Name	98
		AirPlay	98

*1 Displayed when the "DHCP" setting is "Off".

*2 When connected using a wireless LAN, "Connection Wireless (Wi-Fi)" will be displayed.



Setting items	Detailed items	Description	Page
HEOS Account	[When the user is signed out the HEOS Account]		
	I have a HEOS Account	Selects to sign in.	99
	Create Account	Creates new HEOS Account.	99
	Forgot Password	If you have forgotten the password, an email explaining how to reset the password will be sent.	99
	[When the user is signed in the HEOS Account]		
	Signed in as	Displays your HEOS Account.	99
	Change Location	Selects your location.	99
	Change Password	Changes your HEOS Account Password.	99
	Delete Account	Deletes your HEOS Account.	99
	Sign Out	Sign out of your HEOS Account.	99
Quick Setup	-	Performs the network settings using a Wizard style window. For details on the operations, see the separate "Quick start guide".	-



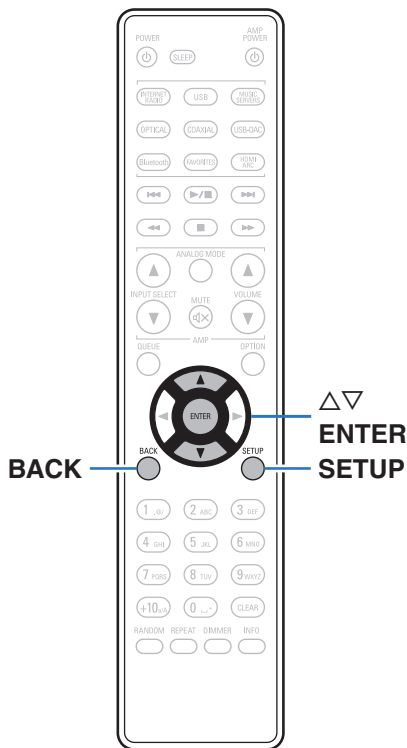

Menu operation

- 1 Press SETUP.**
The menu is displayed on the display.
- 2 Use Δ / ∇ to select the menu to be set or operated, then press ENTER.**
- 3 Use Δ / ∇ to change to desired setting.**
- 4 Press ENTER to enter the setting.**
 - To return to the previous item, press BACK.
 - Exiting the Menu, press SETUP while the menu is displayed. The display returns to the normal display.



Inputting characters

On this unit, you can change the name displayed on the following screens to the names that you prefer.

- Friendly Name (p. 93)
- Character input for the network functions

Using the number buttons

- 1 **Display the screen for inputting characters.**
 - To change a character, use \triangleleft \triangleright to align the cursor with the character that you want to change.
- 2 **Press +10 to select the character type (upper case, lower case, characters with diacritical marks or numeric characters).**

3 Use 0 – 9, +10 until the desired character is displayed.

- The types of characters that can be input are as shown in the following table.

1 .@/	1 . @ - _ / :
2 ABC	a b c A B C 2 ä à á â ã ä å æ ç ç Ä Å Á Â Ã Ä Æ Ç Ç Ć
3 DEF	d e f D E F 3 ð ë è é ê Ë È É Ê Ë
4 GHI	g h i G H I 4 ï ï ï ï ï ï ï
5 JKL	j k l J K L 5
6 MNO	m n o M N O 6 ñ ò ó ô õ ö ø Ñ Ò Ó Ô Õ Ö Ø
7 PQRS	p q r s P Q R S 7 B ř ŕ ś š š ß Ŕ Ŗ Ś Š Š
8 TUV	t u v T U V 8 ü ú ú ü Û Ü Ú Û
9 WXYZ	w x y z W X Y Z 9 ý ž ž þ Ý Ž Ž Þ
0 .-	0 (Space) ! " # \$ % & ' () * + , ; < = > ? [\] ^ ` { } ¡ ¢ £ ¤ § © « ¬ ° ± » ¿

- 4 **Repeat steps 2 and 3 to input characters then press ENTER to register it.**



Audio

Make audio-related settings.

Line Out Level

Set according to the terminal (VARIABLE or FIXED) where the amplifier is connected. Use this setting when connecting a Denon amplifier to this unit using IR control. (🔗 p. 29)

Variable (Default):

When the “Power On Link” function is used, the input source of the Denon amplifier switches to “EXT.PRE.” Control the volume of the audio signal output from this unit’s analog audio output terminals (VARIABLE) with the HEOS app or TV remote control unit (HDMI control function).

Fixed:

When the “Power On Link” function is used, the input source of the Denon amplifier switches to “NETWORK.” Control the volume of the Denon amplifier connected to this unit with the HEOS app or TV remote control unit (HDMI control function).

Volume Limit

Make a setting for the maximum volume of the audio signal output from the analog audio output terminals (VARIABLE).

Off Do not set a maximum volume. (100
(Default): (+6dB))

95 (+1dB) / 90 (-4dB) / 85 (-9dB) / 80 (-14dB)



H/P Amplifier Gain

Set the gain of the headphone amplifier. Set this according to the impedance of the connected headphones. It is recommended that this is set on the “Low” side if the headphones have low impedance and on the “High” side if they have high impedance.

High:	Set the gain of the headphone amplifier to “High”. Set when there is insufficient volume, even when the gain setting is “Mid”.
Mid (Default):	Set the gain of the headphone amplifier to “Mid”.
Low:	Set the gain of the headphone amplifier to “Low”. Set this if the volume is too high at the factory default setting.

NOTE

- The headphone volume varies depending on the H/P Amplifier Gain setting. Decrease the volume or mute the audio first if changing this setting while listening to audio.



TV

TV Input

Set this when playing audio from a TV on this unit. When the TV is turned on, this unit turns on and the input source is automatically switched to "HDMI ARC", "Optical 1", "Optical 2" or "Coaxial" so that the audio from the TV can be played through this unit.

■ Default Input

Set the input source to be used when playing audio from the TV through this unit. Set this according to the jack on this unit being used to connect to the TV (HDMI ARC, OPTICAL 1, OPTICAL 2 or COAXIAL).

None / HDMI Out (ARC) / Optical In 1 / Optical In 2 / Coaxial In
(Default: HDMI Out (ARC))

■ Auto-Play

When a TV audio source is input to this unit, the unit automatically switches to the input source set in "Default Input" and the Auto-Play function for playing TV audio on this unit is set.

On
(Default): Enables the Auto-Play function.

Off: Disables the Auto-Play function.



- The Auto-Play function does not work when "Default Input" is set to "None". Set "Default Input" in advance.
- The Auto-Play function will not work if the sampling frequency of the audio signal input from this unit's OPTICAL 1 and 2 input terminals and COAXIAL input terminal is 88.2 kHz or more. TVs normally output 48 kHz audio signals and the Auto-Play function will work, but if you connect a device that outputs an audio signal of 88.2 kHz or more and try to use it, the Auto-Play function may not work.



HDMI Power Off Control

Set the “HDMI Power Off Control” function that is keyed to the power off operation of your HDMI connected TV to turn the device's power to standby.

All (Default) :	Regardless of the input source of this device, if the power of the TV is turned off, the power of this device automatically becomes standby.
HDMI ARC:	If the input source is HDMI ARC and you power off the TV, the power of this device automatically becomes standby.
Off:	This unit is not linked to the power of the TV.



General

Language

Sets the language for display the menu.

English / Deutsch / Français / Italiano / Nederlands / Español / Svenska / Русский / Polski (Default : English)

Auto-Standby

Sets the amount of time that must elapse without unit operation or an input signal before the unit goes into standby automatically.

Off:	The unit does not go into standby automatically.
1min:	The unit goes into standby after 1 minutes.
5min:	The unit goes into standby after 5 minutes.
15min (Default):	The unit goes into standby after 15 minutes.
Other:	Sets the minutes (between 1 and 99) before the unit automatically goes into standby. After setting the amount of time with 0 – 9, +10 buttons, press ENTER to confirm the setting.



Power On Link

Sets the “Power On Link” function, which links the powering on of Denon amplifiers connected to this unit to the powering on of this unit, turning them on when power on operations are performed on this unit.

On (Default):	Power on is linked.
Off:	Power on is not linked.

Usage Data

For product improvement purposes, please send information on the device settings and operating conditions of the functions to Denon. Information provided by customers will be used as reference material for product development purposes in the future.

Denon will never provide any information we collect to third parties.

Yes:	Provide information on the operating status of this unit.
No:	Do not provide information on the operating status of this unit.



Firmware

Checks for and installs the latest firmware information updates and upgrades. Also sets the upgrade notification message display.

■ Check for Update

Check for firmware updates.

The firmware can be updated if a firmware update has been released.

Update Now:	Execute the update process. During the update, the progress is shown on the display.
Update Later:	Update later.



- This unit automatically retries updating if updating fails. If an update still cannot be performed, an “Update Error” message appears in the display. See “Troubleshooting” – “Update/upgrade error messages” for information on update error messages. (🔍 p. 120)
Check the conditions according to the message and try the update again.
- This menu cannot be selected when “Allow Update” is set to “Off”.

■ Auto-Update

This unit will automatically update to the newest firmware when in standby mode.

☐ Auto-Update

This unit will automatically update to the newest firmware when in standby mode.

On: Turns on Automatic Updates.

Off
(Default): Turns off Automatic Updates.

☐ Time Zone

Change the time zone.

Set the time zone that matches the area where you live.



- This menu cannot be selected when “Allow Update” is set to “Off”.



■ Allow Update

Enable or disable updates and upgrades for this unit.

On
(Default): Enables this unit to receive updates and upgrades.

Off: Prevents this unit from receiving update and upgrade.



- This unit and HEOS app may become incompatible when this setting is set to “Off”.

■ Upgrade Notification

When the latest Upgrade firmware is available, a notification message is displayed on the display of this unit at power on.

The notification message is displayed for about 40 seconds when the power is turned on.

On
(Default): Display upgrade message.

Off: Do not display upgrade message.



- This menu cannot be selected when “Allow Update” is set to “Off”.



■ Add New Feature

Display new features that can be downloaded to this unit and perform an upgrade.

Upgrade Package:	Display the items to be upgraded.
Upgrade ID:	The ID number shown on the display is needed when carrying out the procedure.
Upgrade Status:	Display a list of the additional functions provided by the upgrade.
Start Upgrade:	Execute the upgrade process. During the upgrade, the amount of upgrade time which has elapsed is displayed.



- Information regarding the “Update” function and “Add New Feature” will be announced on the Denon website each time related plans are defined. See the Denon website for details about upgrades.
- When the procedure is complete, “Registered” is displayed in this menu and upgrades can be carried out. If the procedure has not been carried out, “Not Registered” is displayed.
- If the upgrade is not successful, “Upgrade Error” message appears in the display. See “Troubleshooting” – “Update/upgrade error messages” for information on upgrade error messages. (🔗 p. 120)
Check the settings and network environment and then perform the upgrade again.
- This menu cannot be selected when “Allow Update” is set to “Off”.

Notes concerning use of “Update” and “Add New Feature”

- In order to use these functions, you must have the correct system requirements and settings for an Internet connection. (🔗 p. 27)
- Do not turn off the power until updating or upgrading is completed.
- Even with a broadband connection to the Internet, approximately 20 minutes is required for the updating/upgrading procedure to be completed.
- Once updating/upgrade starts, normal operations on this unit cannot be performed until updating/upgrading is completed. Furthermore, there may be cases where backup data is reset for the parameters, etc., set on this unit.
- If the update or upgrade fails, press and hold the ⏻ on the main unit for more than 5 seconds, or remove and re-insert the power cord. After about 1 minute, “Please wait” appears on the display and update restarts. If the error continues, check the network environment.



Information

■ Notification Alerts

Sets whether or not to display the notification when the power is turned on.

On (Default):	Notification messages are displayed.
Off:	Notification messages are not displayed.

■ Check for Notifications

Displays notifications.

Reset

Perform this procedure if the display is abnormal or if operations cannot be performed. Restores the contents of each setting to the factory settings. Make settings again.

Reset factory defaults:	Unit is initialized.
Cancel:	Unit is not initialized.



Network

To use this unit by connecting it to a home network (LAN), you must configure network settings.

If you set up your home network (LAN) via DHCP, set “DHCP” to “On”. (Use the default setting.) This allows this unit to use your home network (LAN).

When assigning an IP address to each device manually, you need to assign an IP address to this unit using the “IP Address” settings, and enter information about your home network (LAN) such as the gateway address and subnet mask, etc.

Network Information

Displays network information.

Friendly Name / Connection / SSID (Wi-Fi Signal Strength) / DHCP / IP Address / MAC Address (Ethernet) / MAC Address (Wi-Fi)

Network & USB-A

The network and USB flash drive playback (USB-A) functions can be stopped to prevent noise that affects the sound quality. This enables playback with a high sound quality when using the D/A converter functions.

Enabled (Default) :	Enables the network and USB flash drive playback (USB-A) function.
Disabled :	Disables the network and USB flash drive playback (USB-A) function.

Wi-Fi

The Wi-Fi function can be stopped to prevent noise that affects the sound quality. Using a wired LAN to connect this unit to the network enables playback with a high sound quality.

Enabled (Default):	Enables the Wi-Fi function.
Disabled:	Disables the Wi-Fi function.

Bluetooth

Stopping Bluetooth function reduces a source of noise that affects sound quality, enabling higher sound quality playback.

Enabled (Default):	Enables the Bluetooth function.
Disabled:	Disables the Bluetooth function.



Network Control

Enables network communication in standby power mode.

On:	Network is on during standby. Main unit operable with a network compatible controller.
Off (Default):	Suspend network function during standby.



- When using the HEOS app, use with the “Network Control” setting set to “On”.

NOTE

- When “Network Control” is set to “On”, the unit consumes more standby power.

Friendly Name

The Friendly Name is the name of this unit displayed on the network. You can change the Friendly Name according to your preferences.

■ Friendly Name

Selects Friendly Name from the list.

When you select “Other”, you can change the Friendly Name according to your preferences.

Current Friendly Name / Home Theater / Living Room / Family Room / Guest Room / Kitchen / Dining Room / Master Bedroom / Bedroom / Den / Office / Denon DNP-2000NE / Other



- Up to 30 characters can be input.
- For character input, see “Inputting characters” (👉 p. 80).
- The default Friendly Name on first use is “Denon DNP-2000NE”.



Connection

Choose whether to connect the home network to a wireless LAN or a wired LAN.

When connecting to the network using wired LAN, select “Wired” after connecting a LAN cable.

When connecting to the network using wireless LAN, select “Wi-Fi” and configure the “Wi-Fi Setup”. (🖱️ p. 94)

Wi-Fi:	Use the wireless LAN (Wi-Fi) function to connect to a network.
Wired:	Use a LAN cable to connect to a network.

■ Wi-Fi Setup

Connect to a wireless LAN (Wi-Fi) router.

The router can be connected in the following ways. Select the connection method to suit your home environment.



- “Wi-Fi Setup” is not displayed in the setting menu when “Connection” in the setting menu is set to “Wired”.

□ Auto-Scan

Select the network you wish to connect to from the list of possible networks shown on the display.

1. Select the network you wish to connect to from the list of wireless networks.
Select “Rescan” if the network cannot be found.
2. Enter your password and press ENTER.



❑ Share Wi-Fi setting from an iOS device

Use your iOS device (iPhone/iPod/iPad) to connect to the network. By connecting your iOS device to this unit using Wi-Fi, the unit can be automatically connected to the same network as your device.

1. Select “Share Wi-Fi setting from an iOS device” on the display.
2. Check that your iOS device is connected to the wireless LAN (Wi-Fi) router and select “Denon DNP-2000NE” from “SET UP NEW AIRPLAY SPEAKER...” at the bottom of the Wi-Fi configuration screen of your iOS device.
3. Tap “Next” on the screen of the iOS device.



- The iOS device firmware version needs to support iOS 7 or later.

❑ WPS Router

Use a WPS-compatible router to connect using the push button method.

1. Select “WPS Router” on the display.
2. Switch to the WPS mode by pressing the WPS button of the router you wish to connect to.
 - The time for pressing the button varies depending on the router.
3. Press ENTER within 2 minutes.



Manual

Enter the name (SSID) and password of the network you wish to connect to.

1. Set the following items.

SSID:	Input the name of the wireless network (SSID).
Security:	Select the encryption method according to the encryption setting of the access point you are using.
Password:	Input the password.

2. Select "Test Connection" at the end of the setting.



- The wireless LAN (Wi-Fi) settings of this unit can also be configured from a PC or tablet that supports wireless LAN connection.
 1. Press and hold the SOURCE and BACK buttons on the main unit for at least 3 seconds when the power of the unit is on.
 2. Connect the wireless LAN of the PC or tablet used to "Denon DNP-2000NE" when the message "Connect your Wi-Fi device to Wi-Fi network called "Denon DNP-2000NE"" appears in the display.
 3. Start up the browser and enter "192.168.1.16/settings/" in the URL.
 4. Use the browser to enter the settings, select "Save Settings" and then exit the settings.
- Set "1" as the default key setting of the router when connecting to a WEP encrypted network. (The default key of this unit is fixed as "1".)



Settings

Configure the IP address.

- If you are using a broadband router (DHCP function), the information required for network connection such as the IP address will be automatically configured since the DHCP function is set to “On” in the default settings of this unit.
- Set up the IP Address, Subnet Mask, Gateway and DNS server information only when assigning a fixed IP address or when connecting to a network without DHCP function.

■ DHCP

Selects how to connect to the network.

On (Default):	Configure the network settings automatically from your router.
Off:	Configure the network settings manually.

■ IP Address

Set the IP address within the ranges shown below.

- The Network Audio function cannot be used if other IP addresses are set.
 CLASS A: 10.0.0.1 - 10.255.255.254
 CLASS B: 172.16.0.1 - 172.31.255.254
 CLASS C: 192.168.0.1 - 192.168.255.254

■ Subnet Mask

When connecting an xDSL modem or connector adapter directly to this unit, input the subnet mask indicated in the documentation supplied by your provider. Normally input 255.255.255.0.

■ Gateway

When connected to a gateway (router), input its IP address.

■ DNS

Enter the DNS address indicated in the documentation supplied by your provider.

■ Save

Save settings



- If you cannot connect to the Internet, recheck the connections and settings. (☞ p. 27)
- If you do not understand about Internet connection, contact your ISP (Internet Service Provider) or the store from which you purchased your computer.



Diagnostics

Used to check the network connection.

■ Physical Connection

Checks the physical LAN port connection.

OK

Error:

The LAN cable is not connected. Check the connection.



- When connected using a wireless LAN, “Connection Wireless (Wi-Fi)” will be displayed.

■ Router Access

Checks the connection from this unit to the router.

OK

Error:

Failed to communicate with the router. Check the router settings.

■ Internet Access

Checks whether this unit has access to the Internet (WAN).

OK

Error:

Failed to connect to the Internet. Check the Internet connection environment or router settings.

AirPlay

Settings for Apple AirPlay.

■ AirPlay Name

Displays the name which identifies this unit on Apple devices.



- If you registered this unit to the Apple Home app, use the app to change the name.

■ AirPlay

Enables/disables the Apple AirPlay.

On

(Default):

Enables Apple AirPlay.

Off:

Disables Apple AirPlay.



HEOS Account

Make HEOS Account-related settings.

HEOS Account is needed in order to use HEOS Favorites.

The menu displayed differs depending on the status of the HEOS Account.

You have not signed in

■ I have a HEOS Account

If you already have a HEOS Account, enter the current account name and password to sign in.

■ Create Account

If you do not have a HEOS Account, create a new HEOS Account.

■ Forgot Password

If you have forgotten the password, an email explaining how to reset the password will be sent.

You have already signed in

■ Signed in as

The currently signed in HEOS Account is displayed.

■ Change Location

Change the regional settings for the signed in HEOS Account.

■ Change Password

Change the password for the signed in HEOS Account.

■ Delete Account

Delete the signed in HEOS Account.

■ Sign Out

Sign out from the HEOS Account.



Switching the function of the volume buttons on the remote control

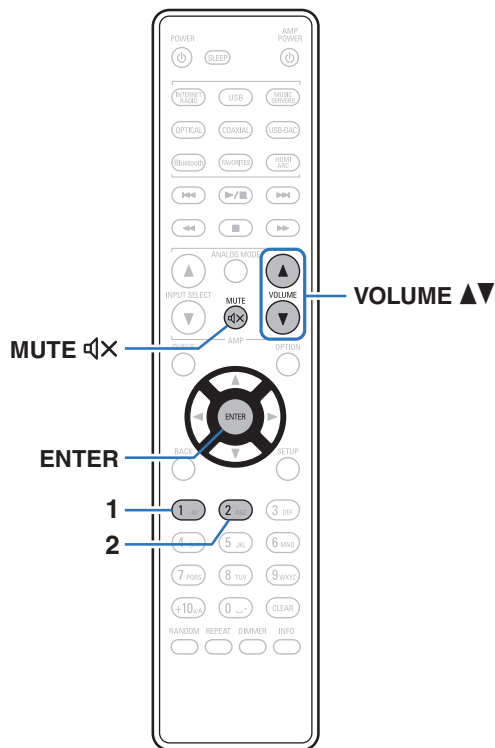

If connecting a power amplifier to the analog audio output terminals (VARIABLE) of this unit, you can change the operation mode of the included remote control so that the volume of the power amplifier can be adjusted from this unit. There are two remote control operation modes: amplifier operation mode and network audio player operation mode. Amplifier operation mode adjusts the volume of a Denon amplifier and network audio player operation mode adjusts the volume of the audio signal output from the analog audio output terminals (VARIABLE) of this unit. The factory default setting for the remote control operation mode is the amplifier operation mode.



- Be sure to check the operation of each unit after setting the remote control operation modes.
- Switch between the remote control operation mode settings by pressing the VOLUME $\blacktriangle \blacktriangledown$ and MUTE M buttons.
- The remote control operation modes returns to the default settings when the batteries are removed. Set the remote control operation modes again after replacing the batteries.



Setting the remote control operation mode to network audio player operation mode

- 1 Press and hold the ENTER and number 2 button on the remote control unit down together for more than 5 seconds.

Setting the remote control operation mode to amplifier operation mode

- 1 Press and hold the ENTER and number 1 button on the remote control unit down together for more than 5 seconds.



■ Contents

Tips

I want to listen to high sound performance playback	103
I want to play TV audio at higher quality	103
I want to turn the display off	103
Simple operations in the power off state	103
I want to connect a power amplifier to this unit	104
I want the volume not to become too loud by mistake	104
I want to prevent this unit from going into standby by linking to the power off operation of an HDMI connected TV	104

Troubleshooting

Power does not turn on/Power is turned off	106
Operations cannot be performed through the remote control unit	107
Display on this unit shows nothing	107
No sound comes out	108
Sound is interrupted or noise occurs	109
Desired sound does not come out	110
AirPlay cannot be played back	111
USB flash drives cannot be played back	112
Bluetooth cannot be played back	113
The Internet radio cannot be played back	114
Music files on PC or NAS cannot be played back (Music server)	115
Various online services cannot be played	116
Cannot connect to a wireless LAN network	116
Music files on PC or Mac cannot be played back (USB-DAC)	118
Audio from digital devices cannot be played back (HDMI ARC/Coaxial/Optical)	119
The input source switches to "HDMI ARC", "Optical 1", "Optical 2" or "Coaxial"	119
The HDMI control function does not work	119
Update/upgrade error messages	120



Tips

I want to listen to high sound performance playback

- The network and USB memory playback (USB-A) functions can be stopped to prevent noise that affects the sound quality. Set “Network & USB-A” to “Disabled” in the menu. (👉 p. 92)
- The Wi-Fi function can be stopped to prevent noise that affects the sound quality. Set “Disabled” to the “Wi-Fi”. (👉 p. 92)
- Stopping Bluetooth function reduces a source of noise that affects sound quality, enabling higher sound quality playback. Set “Disabled” to the “Bluetooth”. (👉 p. 92)

I want to play TV audio at higher quality

- Connect the HDMI terminal of your TV that supports the ARC function to the HDMI ARC terminal of this device and switch the input source to HDMI ARC. (👉 p. 19)
- If you are using a TV that does not support the ARC function or a TV that does not have an HDMI terminal, the TV audio can be played by this device using an Optical or Coaxial connection. (👉 p. 21)
- Only 2-channel linear PCM can be input as the digital audio signal to this unit.

I want to turn the display off

- Press the DIMMER button to turn the display off. (👉 p. 73)

Simple operations in the power off state

- Press the ▶/|| button to automatically turn the unit’s power supply on and start playback of the last selected input source.
- When the “Network Control” function is set to “On”, you can perform playback, or other operations through AirPlay or HEOS app. (👉 p. 93)



I want to connect a power amplifier to this unit

- A power amplifier can be connected to the analog audio output connectors (VARIABLE) on the rear panel. Set “Line Out Level” to “Variable” in the menu and set the remote control operation mode of the volume buttons on the remote control to network audio player operation mode to adjust the volume of the audio signal output from the analog audio output connectors (VARIABLE) using the remote control, TV remote control (HDMI control function) and HEOS app. (“Line Out Level” (👉 p. 82), “Switching the function of the volume buttons on the remote control” (👉 p. 100))

I want the volume not to become too loud by mistake

- Set the volume upper limit for “Volume Limit” in the menu beforehand. This prevents children or others from increasing the volume too much by mistake. (👉 p. 82)

I want to prevent this unit from going into standby by linking to the power off operation of an HDMI connected TV

- Change the “HDMI Power Off Control” setting to “Off”. (👉 p. 85)



Troubleshooting

If a problem should arise, first check the following:

1. Are the connections correct?
2. Is the set being operated as described in the owner's manual?
3. Are the other devices operating properly?



- If steps 1 to 3 above do not improve the problem, restarting the device may improve the problem.
Continue pressing the  button on the unit until "Restart" appears in the display, or remove and re-insert the power cord of the unit.



If this unit does not operate properly, check the corresponding symptoms in this section.

If the symptoms do not match any of those described here, consult your dealer as it could be due to a fault in this unit. In this case, disconnect the power immediately and contact the store where you purchased this unit.



Power does not turn on / Power is turned off

Power is not turned on.

- Check whether the power plug is correctly inserted into the power outlet. (👉 p. 30)
- This unit is in standby mode. Press the  button on the unit or the POWER  button on the remote control. (👉 p. 32)

Power automatically turns off.

- The sleep timer is set. Turn on the power again. (👉 p. 73)
- “Auto-Standby” is set. “Auto-Standby” is triggered when there is no operation for a set amount of time. To disable “Auto-Standby”, set “Auto-Standby” on the menu to “Off”. (👉 p. 86)
- “HDMI Power Off Control” is set. The power of this unit turns off (standby) by linking to the power off operation of an HDMI connected TV. To disable “HDMI Power Off Control”, set “HDMI Power Off Control” on the menu to “Off”. (👉 p. 85)



Operations cannot be performed through the remote control unit

Operations cannot be performed through the remote control unit.

- Batteries are worn out. Replace with new batteries. (🔧 p. 7)
- Operate the remote control unit within a distance of about 7 m from this unit and at an angle of within 30°. (👉 p. 7)
- Remove any obstacle between this unit and the remote control unit.
- Insert the batteries in the proper direction, checking the ⊕ and ⊖ marks. (🔧 p. 7)
- The unit's remote control sensor is exposed to strong light (direct sunlight, inverter type fluorescent bulb light, etc.). Move the set to a place in which the remote control sensor will not be exposed to strong light.
- When using a 3D video device, the remote control unit of this unit may not function due to effects of infrared communications between units (such as TV and glasses for 3D viewing). In this case, adjust the direction of units with the 3D communications function and their distance to ensure they do not affect operations from the remote control unit of this unit.

Display on this unit shows nothing

Display is off.

- Press the DIMMER button, and change the setting to anything other than off. (🔧 p. 73)



No sound comes out

No sound is produced. Or sound is distorted.

- Check the connections for all devices. (👉 p. 17)
- Insert connection cables all the way in.
- Check that input connectors and output connectors are not reversely connected.
- Check cables for damage.
- Check the amplifier's functions and controls and adjust as necessary.
- Digital audio output stops when playing a file with a DSD signal or a linear PCM signal with a sampling frequency of 352.8 kHz or higher.



Sound is interrupted or noise occurs

During playback from the Internet radio or USB flash drive, sound is occasionally interrupted.

- When the transfer speed of the USB flash drive is slow, sound may occasionally be interrupted.
- The network communication speed is slow or the radio station is busy.

Sound is interrupted during playback of tracks saved on a computer.

- Do not start applications other than the player software while playing music on your computer.
- The sound may be interrupted depending on the hardware or software configuration of the computer being used.

When making a call on mobile phone, noise occurs in audio output on this unit.

- When making a call, keep a distance of 20 cm or longer between mobile phone and this unit.

Sound cuts out when using Wi-Fi connection.

- The frequency band used by the wireless LAN is also used by microwave ovens, cordless telephones, wireless game controllers and other wireless LAN devices. Using such devices at the same time as this unit may cause sound to cut out due to electronic interference. Sound cut out can be improved using the following methods. (🔍 p. 27)
 - Install devices that cause interference away from this unit.
 - Turn off the power supply to devices that cause interference.
 - Change the settings of the router channel to which this unit is connected to. (See the instruction manual of the wireless router for details on how to change the channel.)
 - Switch to a wired LAN connection.
- Particularly when you play back large music files, depending on your wireless LAN environment, the playback sound may be interrupted. In this case, make the wired LAN connection. (🔍 p. 94)



Desired sound does not come out

The volume does not increase.

- The maximum volume of the audio signal output from the analog audio output terminals (VARIABLE) is set too low. Set the maximum volume using "Volume Limit" on the menu. (👉 p. 82)

Headphone volume is low.

- Switch "H/P Amplifier Gain" to "High" if using headphones with high impedance or low sensitivity. (👉 p. 83)



AirPlay cannot be played back

The AirPlay icon is not displayed on iTunes / iPhone / iPod touch / iPad.

- This unit and PC / iPhone / iPod touch / iPad are not connected to the same network (LAN). Connect it to the same LAN as this unit. (👉 p. 27)
- The firmware on iTunes / iPhone / iPod touch / iPad is not compatible with AirPlay. Update the firmware to the latest version.
- Set “Network & USB-A” in the menu to “Enabled”. The AirPlay function does not work when “Network & USB-A” is “Disabled”. (👉 p. 92)

Audio is not output.

- The volume on iTunes / iPhone / iPod touch / iPad is set to the minimum level. The volume of the audio output from the analog audio output connectors (VARIABLE) is linked to the volume of your iTunes / iPhone / iPod touch / iPad. Set a proper volume level.
- The AirPlay playback is not performed, or this unit is not selected. Click the AirPlay icon on the iTunes / iPhone / iPod touch / iPad screen and select this unit. (👉 p. 68)

Audio is interrupted during the AirPlay playback on iPhone / iPod touch / iPad.

- Quit the application running in the background of the iPhone/iPod touch/iPad, and then play using AirPlay.
- Some external factors may be affecting the wireless connection. Modify the network environment by taking measures such as shortening the distance from the wireless LAN access point.

iTunes cannot be played back through the remote control unit.

- Enable the “Allow iTunes audio control from remote speakers” setting on iTunes. Then, you can perform playback, pause, and skip operations through the remote control unit.



USB flash drives cannot be played back

USB flash drive is not recognized.

- Disconnect and reconnect the USB flash drive. (👉 p. 26)
- Mass storage class compatible USB flash drives are supported.
- This unit does not support a connection through a USB hub. Connect the USB flash drive directly to the USB port.
- The USB flash drive must be formatted to FAT32 or NTFS.
- Not all USB flash drives are guaranteed to work. Some USB flash drives are not recognized. When using a type of portable hard disc drive compatible with the USB connection that requires power from an AC adapter, use the AC adapter that came with the drive.
- Set “Network & USB-A” in the menu to “Enabled”. The USB flash drive playback function does not work when “Network & USB-A” is “Disabled”. (👉 p. 92)

Files on the USB flash drive are not displayed.

- Files of a type not supported by this unit are not displayed. (👉 p. 123)
- This unit is able to display files in a maximum of eight folder layers. A maximum of 5000 files (folders) can also be displayed for each layer. Modify the folder structure of the USB flash drive.
- When multiple partitions exist on the USB flash drive, only files on the first partition are displayed.

iOS and Android devices are not recognized.

- The USB port of this unit does not support playback from iOS and Android devices.



Files on a USB flash drive cannot be played.

- Files are created in a format that is not supported by this unit. Check the formats supported by this unit. (👉 p. 123)
- You are attempting to play a file that is copyright protected. Files that are copyright protected cannot be played on this unit.
- Playback may not be possible if the album art file size exceeds 2 MB.



Bluetooth cannot be played back

Bluetooth devices cannot be connected to this unit.

- The Bluetooth function in the Bluetooth device has not been enabled. See the Owner's Manual of the Bluetooth device to enable the Bluetooth function.
- Bring the Bluetooth device near to this unit.
- The Bluetooth device cannot connect with this unit if it is not compatible with the A2DP profile.
- Turn the power of the Bluetooth device off and on again, and then try again.
- Set "Bluetooth" in the menu to "Enabled". The Bluetooth function does not work when "Bluetooth" is "Disabled".
( p. 92)
- Set "Network & USB-A" in the menu to "Enabled". The Bluetooth function does not work when "Network & USB-A" is "Disabled". ( p. 92)

The sound is cut off.

- Bring the Bluetooth device near to this unit.
- Remove obstructions between the Bluetooth device and this unit.
- To prevent electromagnetic interference, locate this unit away from microwave ovens, wireless LAN devices and other Bluetooth devices.
- Reconnect the Bluetooth device.



The Internet radio cannot be played back

A list of broadcasting stations is not displayed.

- The LAN cable is not properly connected, or the network is disconnected. Check the connection status. (👉 p. 27)
- Perform the network diagnostic mode.

Internet Radio cannot be played.

- The selected radio station is broadcasting in a format that is not supported by this unit. Formats that can be played back in this unit are WMA, MP3 and MPEG-4 AAC. (👉 p. 127)
- The firewall function is enabled on the router. Check the firewall setting.
- The IP address is not properly set. (👉 p. 97)
- Check the power of the router is on.
- To obtain the IP address automatically, enable the DHCP server function on the router. Also, set the DHCP setting to “On” on this unit. (👉 p. 97)
- To obtain the IP address manually, set the IP address on this unit. (👉 p. 97)
- Some radio stations broadcast silently during some time period. In this case, no audio is output. Wait for a while and select the same radio station, or select another radio station. (👉 p. 35)
- The selected radio station is not in service. Select a radio station in service.

Cannot connect to favorite radio stations.

- Radio station is not currently in service. Register radio stations in service.



Music files on PC or NAS cannot be played back (Music server)

Files stored on a computer cannot be played.

- Files are stored in a non-compatible format. Record in a compatible format. (👉 p. 126)
- Files that are copyright protected cannot be played on this unit.
- Media sharing settings on the server or NAS do not allow this unit. Change the settings to allow this unit. For details, see the owner's manual of the server or NAS.

Server is not found, or it is not possible to connect to the server.

- The computer's or router's firewall is activated. Check the computer's or router's firewall settings.
- Computer's power is not turned on. Turn on the power.
- Server is not running. Launch the server.
- IP address of this unit is wrong. Check the IP address of this unit. (👉 p. 92)

Files on PC or NAS are not displayed.

- Files of a type not supported by this unit are not displayed. (👉 p. 126)

Music stored on a NAS cannot be played.

- If you use a NAS in conformity with the DLNA standard, enable the DLNA server function in the NAS setting.
- If you use a NAS that does not conform with the DLNA standard, play the music via a PC. Set Windows Media Player's media sharing function and add NAS to the selected play folder.
- If connection is restricted, set audio equipment as the connection target.



Various online services cannot be played

Various online services cannot be played.

- The online service may have been discontinued.

Cannot connect to a wireless LAN network

Cannot connect to the network.

- The network name (SSID), password and encryption setting have not been set up correctly. Configure the network settings according to the setting details of this unit. (☞ p. 96)
- Shorten the distance from the wireless LAN access point and remove any obstructions to improve access first before re-connecting again. Place the unit away from microwave ovens and other network access points.
- Configure the access point channel settings away from channels that are being used by other networks.
- This unit is not compatible with WEP (TSN).



Cannot connect to a WPS Router.

- Check that the WPS mode of the router is operating.
- Press the WPS button on the router and then press the ENTER button within 2 minutes.
- A router/settings that are compatible with WPS 2.0 standards are required. Set the encryption time to “None”, WPA-PSK (AES) or WPA2-PSK (AES). (🔍 p. 95)
- If the router encryption method is WEP/WPA-TKIP/WPA2-TKIP, you cannot connect by using the WPS button on the router. In this case, use the “Auto-Scan” or “Manual” method to connect.

Cannot connect to the network using iPhone/iPod touch/iPad.

- Update the iPhone/iPod touch/iPad firmware to the latest version.
- When configuring the settings via a wireless connection, iOS 10.0.2 or later needs to be supported.

Cannot connect to the network during standby.

- Set “Network Control” of the settings menu to “On”. If “Network Control” is set to “Off”, the network function is suspended during standby. (🔍 p. 93)



Music files on PC or Mac cannot be played back (USB-DAC)

This unit is not recognized on the computer.

- Reconnect the USB cable to the USB port on your computer. When this unit is still not recognized after reconnection, connect to a different USB port. (👉 p. 25)
- Restart your computer.
- Check the OS of your computer. (👉 p. 48)
- When your computer is running on Windows, a dedicated driver software should be installed. (👉 p. 49)

This unit is not selected as the playback device.

- Select this unit as the playback device in the sound settings on the computer. (👉 p. 48)

“Signal Unlock” is displayed.

- When digital audio signals cannot be detected properly, “Signal Unlock” is displayed. (👉 p. 56)

“Unsupported” is displayed.

- “Unsupported” is displayed when audio signals that are not supported by this unit are input. Check the settings on your computer or player software. (👉 p. 56)
- If the computer you use is macOS, please check if the DNP-2000NE format is set below 384.0 kHz using the Audio MIDI Setup. (👉 p. 55)



Audio from digital devices cannot be played back (HDMI ARC/Coaxial/Optical)

“Signal Unlock” is displayed.

- When digital audio signals cannot be detected properly, “Signal Unlock” is displayed. (🔍 p. 46)

“Unsupported” is displayed.

- “Unsupported” is displayed when audio signals that are not supported by this unit are input. Check the audio output signal format from your digital device. (🔍 p. 46)
- Only the PCM 2-channel setting can be used to play sound from a TV via the HDMI ARC function. Set “PCM 2ch” as the audio format in the TV settings.

The input source switches to “HDMI ARC”, “Optical 1”, “Optical 2” or “Coaxial”

The input source automatically switches to “HDMI ARC”, “Optical 1”, “Optical 2” or “Coaxial” when the TV connected to this unit is turned on.

- Set “Off” to “Auto-Play”. (🔍 p. 84)

The HDMI control function does not work

The HDMI control function does not work.

- You cannot operate devices that are not compatible with the HDMI control function. In addition, depending on the connected device or the settings, the HDMI control function may not work. In this case, operate the external device directly.
- Check that the HDMI control function setting is enabled on TV connected to this unit.



Update/upgrade error messages

If an update/upgrade is interrupted or fails, an error message appears.

Display	Description
Connection failed. Please check your network, then try again.	The network connection is unstable. Connection to the server failed. Check your network environment and try the update again.
Update failed. Please check your network, then try again.	The download of the firmware failed. Check your network environment and try the update again.
Upgrade failed. Please check your network, then try again.	The download of the firmware failed. Check your network environment and try the upgrade again.
Please check your network, unplug and reconnect the power cord, and try again.	The update failed. Press and hold the  on the main unit for more than 5 seconds, or remove and re-insert the power cord. The update restarts automatically.
Please contact customer service in your area.	This unit may be broken. Contact our Customer Service Center in your area.



Resetting network settings

If network contents cannot be played or the unit cannot connect to the network, restarting the unit may improve the problem. We recommend restarting the unit before returning the settings to the default settings. (☞ p. 105)

If the operations are not improved by restarting the unit, follow the steps below.

Network settings are reset to the factory default values. Make settings again.

However, the menu “Audio” settings are not reset.

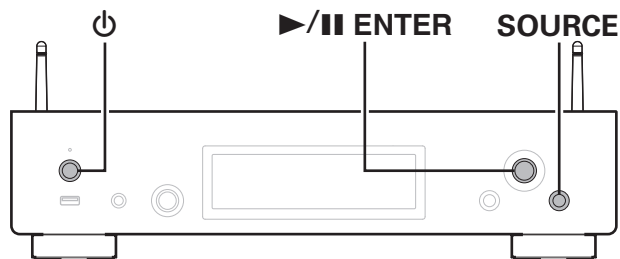

- 1 Press **⏻** to turn on power to the unit.
- 2 Press **SOURCE** to select “Internet Radio”, “Music Servers” or “USB Music”.
- 3 When the power to this unit is on, press and hold **⏻** for 3 seconds or more while pressing **▶/|| ENTER** on the main unit.
- 4 Remove your fingers from the two buttons when “Please wait” appears on the display.
- 5 “Completed” is shown in the display when reset is complete.

NOTE

- Do not turn the power off until reset is complete.



Factory Restore

When the unit or the network functions do not work properly, operation may be improved by performing the Factory Restore.

Perform this operation if it does not work after attempting “General” - “Reset” of the settings menu. (☞ p. 91)

After performing the Factory Restore, various settings are reset to the default settings. Configure the network settings and update the firmware again.

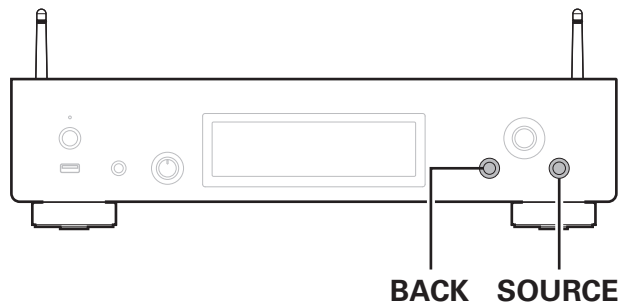

- 1 Unplug the power cord from the power outlet.**
- 2 Plug in the power cord while holding down BACK and SOURCE.**
- 3 When “Factory Restore” appears on the display, release the buttons.**

When the Factory Restore is complete, “Factory Restore Completed” appears on the display for about 5 seconds, and the unit automatically restarts.



- This operation takes time because it requires reconnecting to the network, restoring and updating the firmware.
- If this operation does not improve the problem, contact our customer service center.

NOTE

- Do not turn off the power until the Factory Restore is complete.

WARNING

By initiating Factory Restore mode, you will be installing limited recovery firmware on this unit. Functionality will remain limited until a firmware update is performed over the Internet. Do not perform a Factory Restore if you do not have this unit connected to your home network.



Playing back a USB flash drives

- This unit is compatible with MP3 ID3-Tag (Ver. 2) standard.
- This unit is compatible with WMA META tags.
- If the image size (pixels) of an album artwork exceeds 500 × 500 (WMA/MP3/Apple Lossless/DSD) or 349 × 349 (MPEG-4 AAC), then music may not be played back properly.

■ Specifications of supported files

	Sampling frequency	Bit rate	Extension
WMA*1	32/44.1/48 kHz	48 – 192 kbps	.wma
MP3	32/44.1/48 kHz	32 – 320 kbps	.mp3
WAV	32/44.1/48/88.2/ 96/176.4/192 kHz	–	.wav
MPEG-4 AAC*1	32/44.1/48 kHz	48 – 320 kbps	.aac/.m4a
FLAC	44.1/48/88.2/ 96/176.4/192 kHz	–	.flac
Apple Lossless*2	44.1/48/88.2/ 96/176.4/192 kHz	–	.m4a
DSD	2.8/5.6 MHz	–	.dsf/.dff

*1 Only files that are not protected by copyright can be played on this unit.
Content downloaded from pay sites on the Internet are copyright protected. Also, files encoded in WMA format when ripped from a CD, etc. on a computer may be copyright protected, depending on the computer's settings.

*2 The Apple Lossless Audio Codec (ALAC) decoder is distributed under the Apache License, Version 2.0 (<http://www.apache.org/licenses/LICENSE-2.0>).



■ Maximum number of playable files and folder

The limits on the number of folders and files that can be displayed by this unit are as follows.

Item	Media	USB flash drive
Number of folder directory levels *1		8 levels
Number of folders		500
Number of files*2		5000

*1 The limited number includes the root folder.

*2 The allowable number of files may differ according to the USB flash drive capacity and the file size.

NOTE

- Digital audio output stops during playback of the DSD files.

D/A converter

■ Specifications of supported audio formats

□ USB-DAC

	Sampling frequency	Bit length
DSD (2-channel)	2.8/5.6/ 11.2 MHz	1 bit
Linear PCM (2-channel)	44.1/48/88.2/96/ 176.4/192/352.8/ 384 kHz	16/24/32 bits



- Digital audio output stops during playback of the DSD files and linear PCM signals with a sampling frequency of 352.8/384 kHz.

□ HDMI ARC/Coaxial/Optical

	Sampling frequency	Bit length
Linear PCM (2-channel)	32/44.1/48/88.2/96/ 176.4/192 kHz	16/24 bits



Playing back a Bluetooth device

This unit supports the following Bluetooth profile.

- A2DP (Advanced Audio Distribution Profile):
When a Bluetooth device that supports this standard is connected, monaural and stereo sound data can be streamed at a high quality.
- AVRCP (Audio/Video Remote Control Profile):
When a Bluetooth device that supports this standard is connected, the Bluetooth device can be operated from this unit.

■ About Bluetooth communications

Radio waves broadcast from this unit may interfere with the operation of medical devices. Make sure you turn off the power of this unit and Bluetooth device in the following locations as radio wave interference may cause malfunctions.

- Hospitals, trains, aircraft, petrol kiosks and places where flammable gases are generated
- Near automatic doors and fire alarms



Playing back files stored on a PC and NAS

- This unit is compatible with MP3 ID3-Tag (Ver. 2) standard.
- This unit is compatible with WMA META tags.
- If the image size (pixels) of an album artwork exceeds 500 × 500 (WMA/MP3/WAV/FLAC) or 349 × 349 (MPEG-4 AAC), then music may not be played back properly.
- A server or server software compatible with distribution in the corresponding formats is required to play music files via a network.

For playing mentioned audio formats via a network a server software, for example Twonky Media Server or jRiver Media Server, needs to be installed on your computer or NAS for full support. There are other server software available too. Please check supported formats.

■ Specifications of supported files

	Sampling frequency	Bit rate	Extension
WMA*1	32/44.1/48 kHz	48 – 192 kbps	.wma
MP3	32/44.1/48 kHz	32 – 320 kbps	.mp3
WAV	32/44.1/48/88.2/96/ 176.4/192 kHz	–	.wav
MPEG-4 AAC*1	32/44.1/48 kHz	48 – 320 kbps	.aac/.m4a
FLAC	44.1/48/88.2/ 96/176.4/192 kHz	–	.flac
Apple Lossless*2	44.1/48/88.2/ 96/176.4/192 kHz	–	.m4a
DSD	2.8/5.6 MHz	–	.dsf/.dff

*1 Only files that are not protected by copyright can be played on this unit.

Content downloaded from pay sites on the Internet are copyright protected. Also, files encoded in WMA format when ripped from a CD, etc., on a computer may be copyright protected, depending on the computer's settings.

*2 The Apple Lossless Audio Codec (ALAC) decoder is distributed under the Apache License, Version 2.0 (<http://www.apache.org/licenses/LICENSE-2.0>).

NOTE

- Digital audio output stops during playback of the DSD files.



Playing back Internet Radio

■ Playable broadcast station specifications

	Sampling frequency	Bit rate	Extension
WMA	32/44.1/48 kHz	48 – 192 kbps	.wma
MP3	32/44.1/48 kHz	32 – 320 kbps	.mp3
MPEG-4 AAC	32/44.1/48 kHz	48 – 320 kbps	.aac/ .m4a

Last function memory

This function stores the settings which were made before going into the standby mode.



About HDMI

This unit supports the following HDMI functions.

- **ARC (Audio Return Channel) function**

Enjoy movies, music, etc., on your TV simply by connecting an ARC function-compatible TV to this unit via HDMI.

- **HDMI control function**

Connect an HDMI control-compatible TV and this unit via HDMI and enable the HDMI control to enable linked control from either device.

- Input source switching

If the TV is turned on, this unit automatically powers on and switches the input source.

- Power off link

The TV power off operation is linked so this unit also turns off.

- Volume adjustment

Use the remote control unit to adjust the volume for the audio signal output from the analog audio output terminals (VARIABLE) of this unit.

- Audio output destination switching

If this unit is turned on, TV audio is output from this unit. If this unit is turned off, TV audio is output from the speakers of the TV.



- Some functions may not operate depending on the connected TV.



Explanation of terms

■ Audio

Apple Lossless Audio Codec

This is a codec for lossless audio compression method developed by Apple Inc. This codec can be played back on iTunes, iPod or iPhone. Data compressed to approximately 60 – 70 % can be decompressed to exactly the same original data.

DSD (Direct-Stream Digital)

One of the audio data recording methods, it is the signal aspect used to store audio signals on a super audio CD, and is Δ - Σ modulated digital audio.

FLAC (Free Lossless Audio Codec)

FLAC stands for Free lossless Audio Codec, and is a lossless free audio file format. Lossless means that the audio is compressed without any loss in quality.

The FLAC license is as shown below.

Copyright (C) 2000,2001,2002,2003,2004,2005,2006,2007,2008,2009
Josh Coalson

Redistribution and use in source and binary forms, with or without modification, are permitted provided that the following conditions are met:

- Redistributions of source code must retain the above copyright notice, this list of conditions and the following disclaimer.
- Redistributions in binary form must reproduce the above copyright notice, this list of conditions and the following disclaimer in the documentation and/or other materials provided with the distribution.
- Neither the name of the Xiph.org Foundation nor the names of its contributors may be used to endorse or promote products derived from this software without specific prior written permission.



THIS SOFTWARE IS PROVIDED BY THE COPYRIGHT HOLDERS AND CONTRIBUTORS "AS IS" AND ANY EXPRESS OR IMPLIED WARRANTIES, INCLUDING, BUT NOT LIMITED TO, THE IMPLIED WARRANTIES OF MERCHANTABILITY AND FITNESS FOR A PARTICULAR PURPOSE ARE DISCLAIMED. IN NO EVENT SHALL THE FOUNDATION OR CONTRIBUTORS BE LIABLE FOR ANY DIRECT, INDIRECT, INCIDENTAL, SPECIAL, EXEMPLARY, OR CONSEQUENTIAL DAMAGES (INCLUDING, BUT NOT LIMITED TO, PROCUREMENT OF SUBSTITUTE GOODS OR SERVICES; LOSS OF USE, DATA, OR PROFITS; OR BUSINESS INTERRUPTION) HOWEVER CAUSED AND ON ANY THEORY OF LIABILITY, WHETHER IN CONTRACT, STRICT LIABILITY, OR TORT (INCLUDING NEGLIGENCE OR OTHERWISE) ARISING IN ANY WAY OUT OF THE USE OF THIS SOFTWARE, EVEN IF ADVISED OF THE POSSIBILITY OF SUCH DAMAGE.

Linear PCM

This is an uncompressed PCM (Pulse Code Modulation) signal. Unlike lossy compression audio sources such as MP3, no audio quality or dynamic range deteriorates.

MP3 (MPEG Audio Layer-3)

This is an internationally standardized audio data compression scheme, using the "MPEG-1" video compression standard. It compresses the data volume to about one eleventh its original size while maintaining sound quality equivalent to a music CD.

MPEG (Moving Picture Experts Group), MPEG-2, MPEG-4

These are the names for digital compression format standards used for the encoding of video and audio. Video standards include "MPEG-1 Video", "MPEG-2 Video", "MPEG-4 Visual", "MPEG-4 AVC". Audio standards include "MPEG-1 Audio", "MPEG-2 Audio", "MPEG-4 AAC".

WMA (Windows Media Audio)

This is the audio compression technology developed by Microsoft Corporation.

WMA data can be encoded using Windows Media® Player.

To encode WMA files, only use applications authorized by Microsoft Corporation. If you use an unauthorized application, the file may not work properly.



Sampling frequency

Sampling involves taking a reading of a sound wave (analog signal) at regular intervals and expressing the height of the wave at each reading in digitized format (producing a digital signal).

The number of readings taken in one second is called the “sampling frequency”. The larger the value, the closer the reproduced sound is to the original.

Greater power can be obtained when this value is smaller.

Bit rate

This expresses the read amount per 1 second of video/audio data recorded in a disc. A larger number means higher sound quality, but also means a larger file size.

■ Network

AirPlay

AirPlay sends (plays) contents recorded in iTunes or on an iPhone/iPod touch to a compatible device via the network.

WEP Key (network key)

This is key information used for encrypting data when conducting data transfer. On this unit, the same WEP key is used for data encryption and decryption, so the same WEP key must be set on both devices in order for communications to be established between them.

Wi-Fi®

Wi-Fi Certification assures tested and proven interoperability by the Wi-Fi Alliance, a group certifying interoperability among wireless LAN devices.

WPA (Wi-Fi Protected Access)

This is a security standard established by the Wi-Fi Alliance. In addition to the conventional SSID (network name) and WEP key (network key), it also uses a user identification function and encrypting protocol for stronger security.

WPA2 (Wi-Fi Protected Access 2)

This is a new version of the WPA established by the Wi-Fi Alliance, compatible with more secure AES encryption.



WPA-PSK/WPA2-PSK (Pre-shared Key)

This is a simple authentication system for mutual authentication when a preset character string matches on the wireless LAN access point and client.

Network Names (SSID: Service Set Identifier)

When forming wireless LAN networks, groups are formed to prevent interference, data theft, etc. These groups are based on "SSID (network names)". For enhanced security, a WEP key is set so that communication is unavailable unless both the "SSID" and the WEP key match. This is suitable for constructing a simplified network.

■ Other

Pairing

Pairing (registration) is an operation that is required in order to connect a Bluetooth device to this unit using Bluetooth. When paired, the devices authenticate each other and can connect without mistaken connections occurring.

When using Bluetooth connection for the first time, you need to pair this unit and the Bluetooth device to be connected.



Trademark information



Apple, AirPlay, iPad, iPad Air, iPad Pro and iPhone are trademarks of Apple Inc., registered in the U.S. and other countries.

The trademark "iPhone" is used in Japan with a license from Aiphone K.K.

Use of the Works with Apple badge means that an accessory has been designed to work specifically with the technology identified in the badge and has been certified by the developer to meet Apple performance standards.



The Bluetooth® word mark and logos are registered trademarks owned by the Bluetooth SIG, Inc. and any use of such marks by D&M Holdings Inc. is under license. Other trademarks and trade names are those of their respective owners.



The Wi-Fi CERTIFIED logo is a registered trademark of the Wi-Fi Alliance.

Wi-Fi Certification provides assurance that the device has passed the interoperability test conducted by the Wi-Fi Alliance, a group that certifies interoperability among wireless LAN devices.



The terms HDMI and HDMI High-Definition Multimedia Interface, and the HDMI Logo are trademarks or registered trademarks of HDMI Licensing, LLC in the United States and other countries.



Specifications

■ Audio section

- Analog output

Channels:

Playable frequency range:

Playable frequency response:

S/N:

Dynamic range:

Harmonic distortion:

- Output level

Unbalanced output (FIXED):

Unbalanced output (VARIABLE):

Headphone output:

- Digital output

Coaxial:

Optical :

[DSD]

2-channel

2 Hz – 100 kHz

2 Hz – 50 kHz (-3 dB)

120 dB (Audible range)

112 dB (Audible range)

0.0006 % (1 kHz, Audible range)

2.2 V (10 k Ω /kohms)

4.5 V (10 k Ω /kohms, variable maximum)

150 mW / 32 Ω /ohms (Gain high)

–

–

[PCM]

2-channel

2 Hz – 20 kHz

2 Hz – 20 kHz (\pm 1 dB)

118 dB (Audible range)

118 dB (Audible range)

0.0008 % (1 kHz, Audible range)

2.2 V (10 k Ω /kohms)

4.5 V (10 k Ω /kohms, variable maximum)

150 mW / 32 Ω /ohms (Gain high)

0.5 Vp-p / 75 Ω /ohms

-19 dBm



■ Wireless LAN section

Network type (wireless LAN standard):	Conforming to IEEE 802.11a/b/g/n/ac (Wi-Fi® compliant) *1
Security:	WEP 64 bit, WEP 128 bit WPA/WPA2-PSK (AES) WPA/WPA2-PSK (TKIP)
Used frequency range:	2.4 GHz, 5 GHz

*1 The Wi-Fi® CERTIFIED Logo and the Wi-Fi CERTIFIED On-Product Logo are registered trademarks of the Wi-Fi Alliance.

■ Bluetooth section





Communications system:	Bluetooth Specification Version 5.0
Transmission power:	Bluetooth Specification Power Class 1
Maximum communication range:	Approx. 30 m in line of sight *2
Used frequency range:	2.4 GHz
Modulation scheme:	FHSS (Frequency-Hopping Spread Spectrum)
Supported profiles:	A2DP (Advanced Audio Distribution Profile) 1.2 AVRCP (Audio Video Remote Control Profile) 1.5
Corresponding codec:	SBC
Transmission range (A2DP):	20 Hz – 20,000 Hz

*2 The actual communication range varies depending on the influence of such factors as obstructions between devices, electromagnetic waves from microwave ovens, static electricity, cordless phones, reception sensitivity, antenna performance, operating system, application software etc.



■ General

Operating temperature:	+5 °C - +35 °C
Power supply:	AC 230 V, 50/60 Hz
Power consumption:	38 W
Power consumption in standby modes :	

Standby modes	Setting items in the menu					Power consumption
	Default Input ( p. 84)	Auto-Play ( p. 84)	Wi-Fi ( p. 92)	Bluetooth ( p. 92)	Network Control ( p. 93)	
Normal standby	None	Off	Disabled	Disabled	Off	0.2 W
Optical standby	Optical In 1 / Optical In 2	On	Disabled	Disabled	Off	0.3 W
CEC standby *3	HDMI Out (ARC)	On	Disabled	Disabled	Off	0.4 W
Wi-Fi connect (5GHz) *3	None	Off	Enabled	Disabled	On	2.0 W
Ethernet connect *3	None	Off	Disabled	Disabled	On	1.5 W
Bluetooth connect *3	None	Off	Disabled	Enabled	On	1.5 W
All standby	HDMI Out (ARC)	On	Enabled	Enabled	On	2.1 W

*3 When this unit enters standby after audio playback using the function in parentheses.

For the purpose of improvement, the specifications and design are subject to change without notice.



■ Dimensions (Unit : mm)

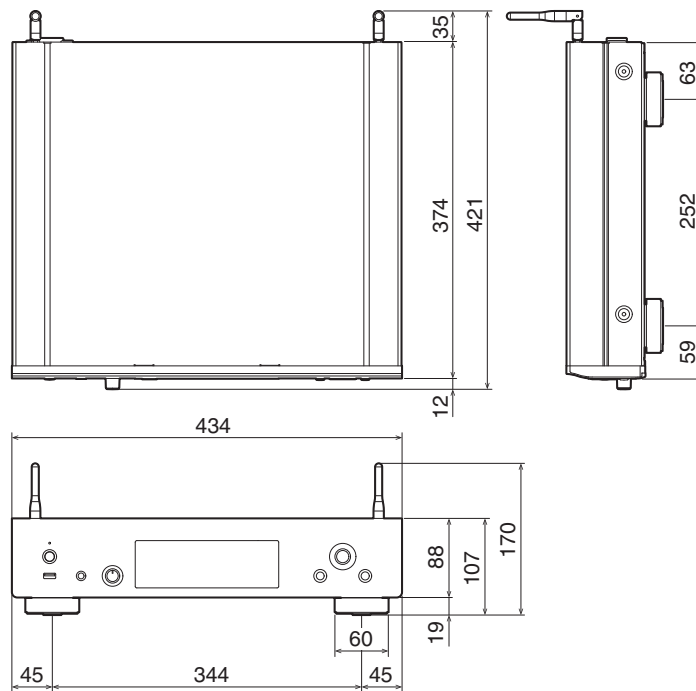

■ Weight : 9.7 kg



Index

A		I		R	
AirPlay	67	Input source	33	Rear panel	10
Amplifier	18	Inputting characters	80	Remote control unit	12
Auto Standby	86	Internet Radio	34		
		M		S	
B		Menu map	74	Sleep timer	73
Bluetooth device	42			Spotify	70
		N			
D		NAS	36, 126	T	
D/A converter function	46, 124	Network settings	92	Tips	103
Display's brightness	73			Troubleshooting	105
		P			
F		Pairing	42	U	
Firmware update	88	PC	27, 36, 126	USB flash drive	26, 39
Front panel	8			USB-DAC	25, 48, 124
		Q			
H		Queue	62	W	
HEOS Account	59, 99			Wi-Fi settings	92
HEOS Favorites	62			Wired LAN	27, 92
				Wireless LAN	28, 92



DENON®

3520 10905 00AD
©2023 Sound United. All Rights Reserved.