



M66

Streaming DAC Preamp

ENGLISH



Owner's Manual

IMPORTANT SAFETY INSTRUCTIONS

- **Read instructions** - All the safety and operating instructions should be read before the product is operated.
- **Retain instructions** - The safety and operating instructions should be retained for future reference.
- **Heed Warnings** - All warnings on the product and in the operating instructions should be adhered to.
- **Follow Instructions** - All operating and use instructions should be followed.
- **Cleaning** - Unplug this product from the wall outlet before cleaning. Do not use liquid cleaners or aerosol cleaners. Use a damp cloth for cleaning.
- **Attachments** - Do not use attachments not recommended by the product manufacturer as they may cause hazards.
- **Water and Moisture** - Do not use this product near water-for example, near a bath tub, wash bowl, kitchen sink, or laundry tub; in a wet basement; or near a swimming pool; and the like.
- **Accessories** - Do not place this product on an unstable cart, stand, tripod, bracket, or table. The product may fall, causing serious injury to a child or adult and serious damage to the product. Use only with a cart, stand, tripod, bracket, or table recommended by the manufacturer, or sold with the product. Any mounting of the product should follow the manufacturer's instructions, and should use a mounting accessory recommended by the manufacturer.
-  **Cart** - A product and cart combination should be moved with care. Quick stops, excessive force, and uneven surfaces may cause the product and cart combination to overturn.
- **Ventilation** - Slots and openings in the cabinet are provided for ventilation to ensure reliable operation of the product and to protect it from overheating. These openings must not be blocked or covered. The openings should never be blocked by placing the product on a bed, sofa, rug, or other similar surface. This product should not be placed in a built-in installation such as a bookcase or rack unless proper ventilation is provided or the manufacturer's instructions have been adhered to.
- **Power Sources** - This product should be operated only from the type of power source indicated on the marking label and connected to a MAINS socket outlet with a protective earthing connection. If you are not sure of the type of power supply to your home, consult your product dealer or local power company.
- **Power-Cord Protection** - Power-supply cords should be routed so that they are not likely to be walked on or pinched by items placed upon or against them, paying particular attention to cords at plugs, convenience receptacles, and the point where they exit from the product.
- **Mains Plug** - Where the mains plug or an appliance coupler is used as the disconnect device, the disconnect device shall remain readily operable.
- **Outdoor Antenna Grounding** - If an outside antenna or cable system is connected to the product, be sure the antenna or cable system is grounded so as to provide some protection against voltage surges and built-up static charges. Article 810 of the National Electrical Code, ANSI/NFPA 70, provides information with regard to proper grounding of the mast and supporting structure, grounding of the lead-in wire to an antenna discharge unit, size of grounding conductors, location of antenna discharge unit, connection to grounding electrodes, and requirements for the grounding electrode.
- **Lightning** - For added protection for this product during a lightning storm, or when it is left unattended and unused for long periods of time, unplug it from the wall outlet and disconnect the antenna or cable system. This will prevent damage to the product due to lightning and power-line surges.
- **Power Lines** - An outside antenna system should not be located in the vicinity of overhead power lines or other electric light or power circuits, or where it can fall into such power lines or circuits. When installing an outside antenna system, extreme care should be taken to keep from touching such power lines or circuits as contact with them might be fatal.
- **Overloading** - Do not overload wall outlets, extension cords, or integral convenience receptacles as this can result in a risk of fire or electric shock.
- **Flame Sources** - No naked flame sources, such as lighted candles, should be placed on the product.
- **Object and Liquid Entry** - Never push objects of any kind into this product through openings as they may touch dangerous voltage points or short-out parts that could result in a fire or electric shock. Never spill liquid of any kind on the product.
- **Headphones** - Excessive sound pressure from earphones and headphones can cause hearing loss.
- **Damage Requiring Service** - Unplug this product from the wall outlet and refer servicing to qualified service personnel under the following conditions:
 - When the power-supply cord or plug is damaged.
 - If liquid has been spilled, or objects have fallen into the product.
 - If the product has been exposed to rain or water.
 - If the product does not operate normally by following the operating instructions. Adjust only those controls that are covered by the operating instructions as an improper adjustment of other controls may result in damage and will often require extensive work by a qualified technician to restore the product to its normal operation.
 - If the product has been dropped or damaged in any way.
 - When the product exhibits a distinct change in performance-this indicates a need for service.
- **Replacement Parts** - When replacement parts are required, be sure the service technician has used replacement parts specified by the manufacturer or have the same characteristics as the original part. Unauthorized substitutions may result in fire, electric shock, or other hazards.
- **Battery Disposal** - When disposing of used batteries, please comply with governmental regulations or environmental public instruction's rules that apply in your country or area.
- **Safety Check** - Upon completion of any service or repairs to this product, ask the service technician to perform safety checks to determine that the product is in proper operating condition.
- **Wall or Ceiling Mounting** - The product should be mounted to a wall or ceiling only as recommended by the manufacturer.

WARNING



THE LIGHTNING FLASH WITH ARROWHEAD SYMBOL, WITHIN AN EQUILATERAL TRIANGLE, IS INTENDED TO ALERT THE USER TO THE PRESENCE OF UNINSULATED "DANGEROUS VOLTAGE" WITHIN THE PRODUCT'S ENCLOSURE THAT MAY BE OF SUFFICIENT MAGNITUDE TO CONSTITUTE A RISK OF ELECTRIC SHOCK TO PERSONS



THE EXCLAMATION POINT WITHIN AN EQUILATERAL TRIANGLE IS INTENDED TO ALERT THE USER TO THE PRESENCE OF IMPORTANT OPERATING AND MAINTENANCE (SERVICING) INSTRUCTIONS IN THE LITERATURE ACCOMPANYING THE APPLIANCE.



WARNING : SHOCK HAZARD - DO NOT OPEN
ATTENTION : RISQUE DE CHOC ELECTRIQUE-NE PAS OUVRI

CAUTION REGARDING PLACEMENT

To maintain proper ventilation, be sure to leave a space around the unit (from the largest outer dimensions including projections) than is equal to, or greater than shown below.

Left and Right Panels: 10 cm

Rear Panel: 10 cm

Top Panel: 10 cm

IMPORTANT SAFETY INSTRUCTIONS

FCC STATEMENT

This equipment has been tested and found to comply with the limits for Class B digital device, pursuant to Part 15 of the FCC Rules. These limits are designed to provide reasonable protection against harmful interference in a residential installation. This equipment generates, uses, and can radiate radio frequency energy and, if not installed and used in accordance with the instructions, may cause harmful interference to radio communications. However, there is no guarantee that interference will not occur in a particular installation. If this equipment does cause harmful interference to radio or television reception, which can be determined by turning the equipment off and on, the user is encouraged to try to correct the interference by one or more of the following measures:

- Reorient or relocate the receiving antenna.
- Increase the separation between the equipment and receiver.
- Connect the equipment into an outlet on a circuit different from that to which the receiver is connected.
- Consult the dealer or an experienced radio TV technician for help.

CAUTION

- Changes or modifications to this equipment not expressly approved by NAD Electronics for compliance could void the user's authority to operate this equipment.
- This device complies with Part 15 of the FCC Rules / Industry Canada licence-exempt RSS standard(s). Operation is subject to the following two conditions:
 - 1 This device may not cause harmful interference, and
 - 2 This device must accept any interference received, including interference that may cause undesired operation.
- Under Industry Canada regulations, this radio transmitter may only operate using an antenna of a type and maximum (or lesser) gain approved for the transmitter by Industry Canada. To reduce potential radio interference to other users, the antenna type and its gain should be so chosen that the equivalent isotropically radiated power (e.i.r.p.) is not more than that necessary for successful communication.
- To prevent electric shock, match wide blade of plug to wide slot, fully insert.
- Marking and rating plate can be found at the rear panel of the apparatus.
- To reduce the risk of fire or electric shock, do not expose this apparatus to rain or moisture. The apparatus shall not be exposed to dripping or splashing and that no objects filled with liquids, such as vases, shall be placed on apparatus.
- Mains plug is used as disconnect device and it should remain readily operable during intended use. In order to disconnect the apparatus from the mains completely, the mains plug should be disconnected from the mains socket outlet completely.
- Battery shall not be exposed to excessive heat such as sunshine, fire or the like.
- Danger of explosion if battery is incorrectly replaced. Replace only with the same or equivalent type.
- An appliance with a protective earth terminal should be connected to a mains outlet with a protective earth connection.

MPE REMINDER

To satisfy FCC/IC RF exposure requirements, a separation distance of 20 cm or more should be maintained between the antenna of this device and persons during device operation. To ensure compliance, operations at closer than this distance is not recommended.

IF IN DOUBT CONSULT A COMPETENT ELECTRICIAN.



This product is manufactured to comply with the radio interference requirements of EEC DIRECTIVE 2004/108/EC.

NOTES ON ENVIRONMENTAL PROTECTION



At the end of its useful life, this product must not be disposed of with regular household waste but must be returned to a collection point for the recycling of electrical and electronic equipment. The symbol on the product, user's manual and packaging point this out.



The materials can be reused in accordance with their markings.

Through re-use, recycling of raw materials, or other forms of recycling of old products, you are making an important contribution to the protection of our environment.

Your local administrative office can advise you of the responsible waste disposal point.

INFORMATION ABOUT COLLECTION AND DISPOSAL OF WASTE BATTERIES (DIRECTIVE 2006/66/EC OF THE EUROPEAN PARLIAMENT AND THE COUNCIL OF EUROPEAN UNION) (FOR EUROPEAN CUSTOMERS ONLY)

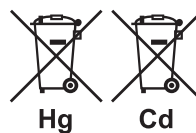

Batteries bearing any of these symbols indicate that they should be treated as "separate collection" and not as municipal waste. It is encouraged that necessary measures are implemented to maximize the separate collection of waste batteries and to minimize the disposal of batteries as mixed municipal waste.

End-users are exhorted not to dispose waste batteries as unsorted municipal waste. In order to achieve a high level of recycling waste batteries, discard waste batteries separately and properly through an accessible collection

point in your vicinity. For more information about collection and recycling of waste batteries, please contact your local municipality, your waste disposal service or the point of sale where you purchased the items.

By ensuring compliance and conformance to proper disposal of waste batteries, potential hazardous effects on human health is prevented and the negative impact of batteries and waste batteries on the environment is minimized, thus contributing to the protection, preservation and quality improvement of the environment.

<p>For indoor use only in the following countries:</p>	BE	SK	PT	NL	LU
	DE	BG	FI	RO	AT
	ES	EE	CZ	SE	SI
	CY	FR	IE	DK	UK
	LV	HR	EL	PL	MT
	LT	IT	HU		

FREQUENCY BAND AND TRANSMISSION POWER

The following frequency band and transmission power are used in this product:

Radio Network	Frequency Band in MHz	Maximum Transmission Power in mW/dBm
Bluetooth	2400 – 2483.5	5.69/7.55
WLAN 2.4 GHz	2412 – 2472	32/15.05
WLAN 5 GHz	5180 – 5320; 5500 – 5700; 5745 – 5825	22/9.65

INTRODUCTION

TABLE OF CONTENTS

IMPORTANT SAFETY INSTRUCTIONS

INTRODUCTION

WHAT'S IN THE BOX	4
FACTORY RESET	4
GETTING STARTED	5
QUICK SETUP GUIDE	5

IDENTIFICATION OF CONTROLS

FRONT PANEL	7
REAR PANEL	8
SRM 1 REMOTE CONTROL	10
USING SRM 1 REMOTE CONTROL	10

OPERATION

USING THE FRONT PANEL DISPLAY	11
SAMPLE DISPLAY SCREEN	11
OTHER FUNCTIONS AND FEATURES	14
BLUETOOTH HEADPHONE/SPEAKER PAIRING	14
MASTER QUALITY AUTHENTICATED	15
DIRAC LIVE	15
MAKING THE MOST OF YOUR M66	15

REFERENCE

SPECIFICATIONS	16
-----------------------------	-----------

WHAT'S IN THE BOX

Packed with your M66 you will find:

- Two detachable mains power cord
- SRM1 remote control with 2 AA batteries
- Mic Assembly with Ferrite Base
- USB MIC Sound Adaptor
- USB flash drive
- Cleaning cloth
- Quick Setup Guide

NOTE

Follow supplied Quick Setup Guide to help you get started with your M66.

SAVE THE PACKAGING

Please save the box and the packaging that came with the M66. Should you move or need to transport your M66, this is the safest container to use. We've seen too many otherwise perfect components damaged in transit for lack of a proper shipping carton. So please, save that box!

FACTORY RESET

Factory Reset is recommended if your M66 is not functioning or internet firmware upgrade has failed. All customizations including Wi-Fi network configuration, file shares and saved playlists will be lost. They have to be re-created once factory reset is completed. M66 can be factory reset or restored to factory default settings using any of the following methods.

1 Via Front Panel Display

Go to **Settings - Other** menu option and select **Factory Reset** to initiate restoring of the M66 to factory default settings. Follow the prompt commands.

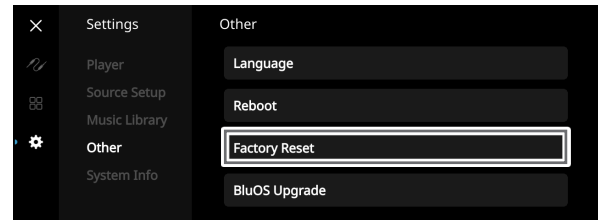

2 Force Factory Reset

- Switch OFF rear panel POWER switch.
- Press and hold rear panel RESET tact switch and while doing so, switch ON the rear panel POWER switch. Do not release hold of the RESET tact switch.
- Hold down the RESET tact switch - STATUS INDICATOR (NAD logo) blinks Red, White and then Red. "BluOS Service Mode" is shown the front panel display. Wait for the front panel display to show "Factory Reset..." and then release hold of the RESET tact switch. Successful Factory Reset is indicated by the unit rebooting.
 - For wireless connection, M66 returns to Hotspot mode and STATUS INDICATOR (NAD logo) indicator turns into solid white.
 - For wired connection, M66 will simply connect as if it was a new player and NAD logo indicator turns into solid white.

IMPORTANT

Releasing the ⏻ (Standby) button switch at any time before the STATUS INDICATOR (NAD logo) begins flashing red will cancel the factory reset and leave the M66 at Upgrade Mode. Just start again the procedure for Factory Reset.

QUICK SETUP GUIDE

This simple guide will help you get started with your M66.

Your M66 can be connected to your home network via **Wired** or **Wireless** connection.

IMPORTANT!

- For wired and wireless connection to be established, ensure that a broadband router that supports Ethernet and/or Wi-Fi standards is setup and available.
- Tablets, smartphones and other applicable devices that support iOS (Apple) or Android operating system can be used as mobile device controller. These devices are not supplied with your M66.
- Download and install the corresponding "BluOS Controller" App for your device.
- The BluOS App is available as a Mobile App for Android, iOS, Kindle and Desktop App for Windows and macOS Computers.
- Mobile Apps are handled by the respective Application Store of the Mobile devices.
- Desktop Apps are available to download directly from the Bluesound homepage - <https://www.bluesound.com>

WIRED CONNECTION

Using an Ethernet cable (not supplied), connect one end to M66's LAN port and the other end directly to your Wired network or router.

WIRELESS CONNECTION

Configure wireless network connection using the smartphone, tablet or computer that applies to you. Connect M66 to your wireless network using any of the following four methods.

- A Wireless Accessory Configuration (WAC) using iOS device
- B Using iOS device
- C Using Android device
- D Wireless Manual Setup

NOTES

- Ensure that there is no established wired connection.
- M66 must be at hot spot mode. M66 default setting is at hot spot mode.
- When BluOS App is opened after wireless setup, the configured M66 network ID or custom name may indicate a "NEEDS SETUP" prompt. Select your M66 network ID or custom name and follow the prompt instructions to complete the setup.

IMPORTANT!

- Always ensure that your M66 is updated with the latest firmware. Go to the M66 product page at nadelectronics.com for firmware update information.
- The following procedures and details may change over time without notice. Always check the NAD M66 product page for the latest updates.

A WIRELESS ACCESSORY CONFIGURATION (WAC) USING iOS DEVICE

Wireless Accessory Configuration (WAC) setup mode is supported by iOS application. At WAC setup mode, network name and password are not required for the M66 to be connected to your network.

- 1 Select "Settings" menu of your iOS device.
- 2 Go to "WiFi" and select the network you would like to use with your M66.
- 3 Scroll down and under "SETUP NEW AIRPLAY SPEAKER", select your M66 speaker indicated by M66-xxxx where xxxx corresponds to the last 4 digits of the Machine Access Control (MAC) address* of your M66. The complete MAC address is printed on a sticker on the M66 rear panel.

- 4 When "AirPlay Setup" screen comes up, select "Next". Note that you can also customize the name of your M66 by entering desired name in the line item "Speaker Name".
- 5 Airplay Setup will proceed automatically. Follow or monitor screen prompts until "Setup Complete" is shown. Select "Done" to complete and exit setup mode.

B USING iOS DEVICE

- 1 Open BluOS App. Select "Players" tab at the bottom section of the BluOS App.
- 2 With available Players shown, select + (Add a Player) at the top right corner of the BluOS App. This will launch the player setup wizard to add a new player to the existing BluOS system.
- 3 From "My Players" screen prompt, select your M66's unique network ID* under "Needs Setup".
- 4 When "AirPlay Setup" screen comes up, select "Next". Note that you can also customize the name of your M66 by entering desired name in the line item "Speaker Name".
- 5 Airplay Setup will proceed automatically. Follow or monitor screen prompts until "Setup Complete" is shown. Select "Done" and then "Finish" to complete and exit setup mode.

C USING ANDROID DEVICE

- 1 Open BluOS App. Select "Players" tab at the bottom section of the BluOS App.
- 2 With available Players shown, select + (Add a Player) at the top right corner of the BluOS App. This will launch the player setup wizard to add a new player to the existing BluOS system.
- 3 Select your M66's unique network ID* from the "My Players" window.
 - a Under "Choose WiFi Network" prompt, select your Home WiFi Network from the "Choose WiFi Network" drop down menu.
 - b If your Home WiFi Network does not appear or is hidden, select "Custom SSID".
 - c Enter "SSID" name.
 - d Select the Network Security your network uses under "Choose Security Method".
- 4 Enter your home network's WiFi Password in the field provided and select "Continue".
- 5 Select or enter preferred "Name" to customize your M66 for easier identification in the Player Drawer. Select "Continue".
- 6 Network setup process proceeds automatically. Follow and complete the prompt messages or instructions.
- 7 Network setup connection is completed when "All done!" is shown in the App. Select "Finish" to complete and exit the wireless setup process.

* The M66's unique network ID is listed as the product name (i.e. M66) immediately followed by the last four digits in the MAC (Machine Access Control) address (example: M66-001A). The complete MAC address is printed on a sticker on the M66 rear panel.

If the above methods do not work or if you are a Windows or Mac user, **Wireless Manual Setup** can be undertaken.

INTRODUCTION

GETTING STARTED

D WIRELESS MANUAL SETUP

- 1** Select your M66's unique network ID* from the WiFi Setup connection settings menu of your tablet, smart phone or computer and connect or join it.
- 2** "...Control Panel" menu window should automatically open. If not, open the web browser of your device and visit **http://10.1.2.3**.
- 3** Select "Configure WiFi" from the "...Control Panel" menu. Select your network or applicable wireless network name (SSID) from the "Configure Wireless" drop down menu.
- 4** Enter your network's Wireless Password (Passphrase, WEP/WAP key as applicable) in the field "Enter password or key (if protected)".
- 5** Select a "Player name" from the drop down list or use the on-screen keyboard to create a customized room name in the field "Custom name".
- 6** Select "Update" to save all your settings. A "Congratulations..." screen prompt will appear to indicate that the setup process of your M66 is completed.
- 7** Do not forget to go back to the WiFi Settings section of your device to confirm that it is reconnected to the correct WiFi network.
- 8** Your M66 is now connected to your WiFi network and ready to be used with the BluOS controller App.

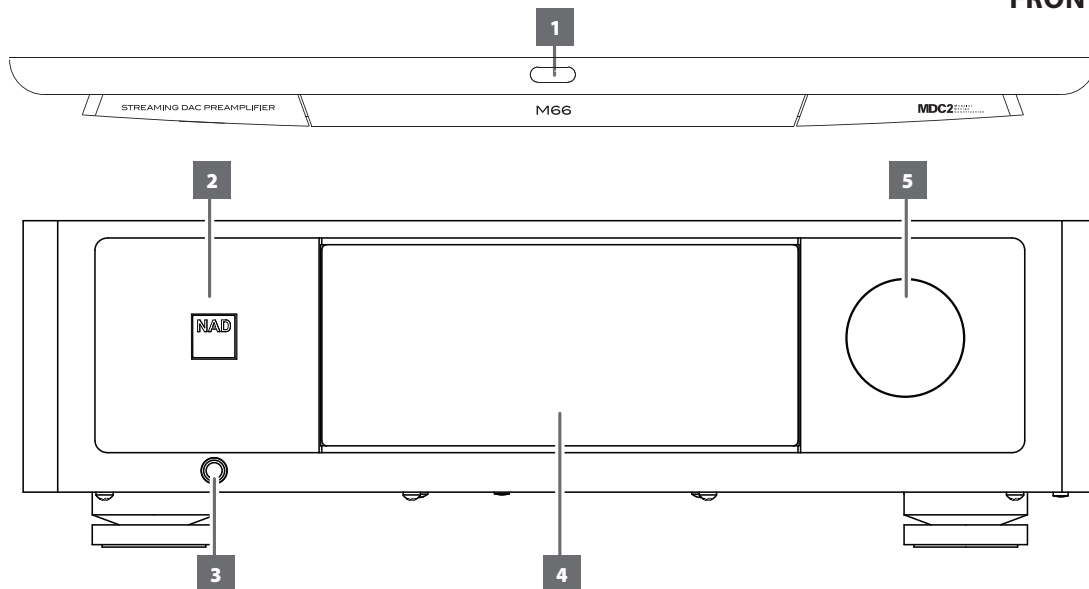

1 ⏻ (STANDBY)

- Press and hold ⏻ (Standby) button to switch M66 from operating mode to standby mode. The STATUS INDICATOR (NAD logo) will illuminate amber at standby mode.
- Press ⏻ (Standby) button to switch ON the M66 from standby mode to operating mode. The STATUS INDICATOR (NAD logo) will turn from amber to white color.
- The ⏻ (Standby) button cannot activate the M66 with the rear panel POWER switched off.

- Network and Bluetooth connections are not maintained at Deep Standby mode.
- At Deep Standby mode, the M66 can be switched back to operating mode using any of the following methods.
 - Touch ⏻ (Standby) button
 - Rotate Volume knob

2 STATUS INDICATOR (NAD LOGO)

- This indicator will be amber when M66 is in standby mode.
- When M66 is powered up from standby mode, this indicator will change from amber to solid white.

IMPORTANT NOTES

- For the ⏻ (Standby) button to activate, two conditions must be completed.
 - Plug-in the supplied mains power cord to mains power source. Connect corresponding end of the mains power cord to the AC mains input of M66 and the plug connected to mains power source.
 - The rear panel POWER switch must be set to ON position.
- When the rear panel POWER switch is switched ON, the unit will automatically turn ON (operating mode) - Status Indicator (NAD logo) will turn red, touch panel display will activate and then Status Indicator (NAD logo) will turn white. It is not necessary to press the ⏻ (Standby) button.

Table of the color blink codes of the NAD logo indicator and their corresponding descriptions.

BLINK CODES	DESCRIPTION
Alternately flashing red and white	Upgrade mode
Solid red	Powering up, rebooting, booting up
Solid amber	Standby mode
Solid white	Indexing
Solid white	Connected to network – ready to use with BluOS App Operating mode

AUTO STANDBY MODES

There are two types of auto standby mode with Amplifier Standby enabled – Network Standby mode and Deep Standby mode.

Network Standby Mode

- If there is no playback or user interface at the current Source within 15 minutes, the unit switches to Network Standby mode at reduced system performance level (less than 8W).
- Network and Bluetooth connections are maintained at Network Standby mode.
- At Network Standby mode, the M66 can be switched back to operating mode using any of the following methods.
 - Touch ⏻ (Standby) button
 - Touch front panel display
 - Rotate Volume knob
 - Activate or play network connected App
 - Play paired Bluetooth source
 - Press ⏻ button from SRM1 remote control

Deep Standby Mode

Activate Deep Standby mode: Press and hold ⏻ (Standby) button for more than 5 seconds until the display turns off and unit goes to deep standby mode.

- At Deep Standby mode, the M66 goes to standby mode at lowest power consumption level (less than 0.5W).

3 HEADPHONE

- A 1/4" stereo jack socket is supplied for headphone listening and will work with conventional headphones of any impedance.
- The volume and tone controls are operative for headphone listening. Use a suitable adapter to connect headphones with other types of sockets, such as 3.5mm "personal stereo" jack plugs.
- Inserting a headphone jack into this socket automatically switches off output at ANALOG AUDIO OUTPUT and SUBWOOFER OUTPUT.

4 DISPLAY (TOUCH PANEL DISPLAY)

- Display visual information about current music or media source, settings or menu options.
- Touch control functions are also displayed depending upon menu option selected.
- Touch the display panel to switch the unit from low power standby mode (no display, NAD logo lit) to operating mode.

5 VOLUME

- The VOLUME control knob adjusts the overall loudness of the signal driving the speakers or headphones.
- Turn clockwise to increase the volume level; counterclockwise to lower it.
- Rotate Volume knob to switch the unit from low power standby mode (no display, NAD logo lit) to operating mode.

IDENTIFICATION OF CONTROLS

REAR PANEL

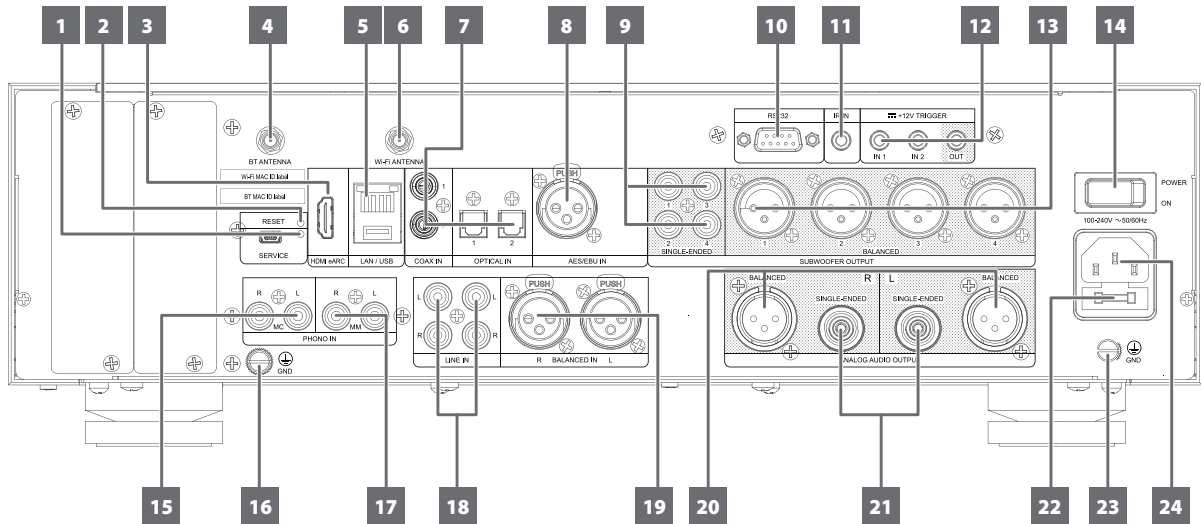

1 SERVICE

- These USB port and tact switch are for servicing purposes only. Not for consumer use.

2 RESET

- Use this tact switch in forcing the factory reset of the unit. Refer to item about FORCE FACTORY RESET under FACTORY RESET section.

3 HDMI eARC

- Connect to TV that supports HDMI Control (CEC) and Audio Return Channel (ARC) or Enhanced Audio Return Channel (eARC) functions. HDMI CEC, ARC and eARC functions are possible if external devices that also support these features are interconnected with M66 via HDMI connection.
- Use HDMI cable to connect HDMI ARC/eARC to corresponding HDMI ARC/eARC port of TV. Use HDMI cable that has Ultra High Speed HDMI Certification Label to enjoy support for larger bandwidth and high bitrate format.
- With ARC/eARC connection established, M66 will output audio signal from TV.

IMPORTANT

- Ensure that the audio setting/format of ARC/eARC-connected devices to M66 is set to PCM only.
- Only audio output signal from TV is supported by HDMI eARC port.

4 BLUETOOTH (BT) ANTENNA TERMINAL

- Install supplied antenna to corresponding BT antenna terminal.

5 LAN/USB LAN

- LAN connection must be setup for wired connection to be established. Set up a Wired Ethernet broadband router with broadband internet connection. Your router or home network should have a built-in DHCP server to consummate the connection.
- Using a standard straight-through Ethernet cable (not supplied), connect one end of the Ethernet cable to the LAN port of your wired Ethernet broadband router and the other end to M66's LAN port.

NOTES

- NAD is not responsible for any malfunction of the M66 and/or the internet connection due to communication errors or malfunctions associated with your broadband internet connection or other connected equipment. Contact your Internet Service Provider (ISP) for assistance or the service bureau of your other equipment.
- Contact your ISP for policies, charges, content restrictions, service limitations, bandwidth, repair and other related issues pertinent to internet connectivity.

USB

- Connect to this USB port a USB drive formatted as FAT32, NTFS or Linux ext4.
- Upon detection of the connected USB drive, an onscreen prompt appears in the BluOS App and also in the front panel display.

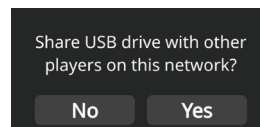

Yes: USB drive is shared with other players on the network from the local Library. Select "Library" from the BluOS App to access the shared USB drive files.

No: USB drive access is restricted only to M66. The connected USB drive appears as a Local Source (USB) in the BluOS App. Access and playback music stored in the connected USB drive by selecting "USB" from the BluOS App.

6 WI-FI ANTENNA TERMINAL

- Install supplied antenna to corresponding Wi-Fi antenna terminal.

7 OPTICAL 1-2/COAXIAL 1-2

- Connect to corresponding optical and coaxial digital output of sources such as CD players, streamers digital cable box, digital tuners and other applicable components.
- The sources will appear as "Optical 1", "Optical 2", "Coaxial 1" and "Coaxial 2" in the navigation drawer of the BluOS App.

8 AES/EBU IN

- Digital audio stream from professional audio sources can be connected to this XLR connector. For high-end sources with higher sampling rates like 176kHz and 192kHz, it is highly recommended that such sources be interfaced with the AES/EBU IN connector. The AES/EBU IN is well suited to handle such sources with high sampling rate.
- The source will appear as "AES/EBU" in the navigation drawer of the BluOS App.

9 SUBWOOFER OUTPUT – SINGLE-ENDED 1-4

- Connect SUBWOOFER OUTPUT SINGLE-ENDED 1, SINGLE-ENDED 2, SINGLE-ENDED 3 and SINGLE-ENDED 4 to the low level input of corresponding powered subwoofers.
- Low frequency information below the selected crossover setting is sent to the connected subwoofer.

10 RS 232

- NAD is an integration partner with several smart control and automation systems like Control4, Crestron, LUTRON among others. Check out NAD website for a list of NAD's integration partners. See your NAD audio specialist for more information.
- Connect this interface using RS-232 serial cable (not supplied) to any Windows compatible PC to allow remote control of M66 via compatible external controllers.
- Refer to NAD website for information about RS232 Protocol documents and PC interface program.

11 IR IN

- This input is connected to the output of an IR (infrared) repeater (Xantech or similar) or IR output of another compatible device to allow control of the M66 from a remote location.

12 +12V TRIGGER IN 1, IN 2, OUT



+12V TRIGGER OUT

- The +12V TRIGGER OUT is used for controlling external equipment equipped with a +12V trigger input.
- Connect this +12V TRIGGER OUT to the other equipment's corresponding +12V DC input jack using a cable with 3.5mm male plug.
- This output will be 12V when the M66 is ON and 0V when it is either OFF or in standby mode.

13 SUBWOOFER OUTPUT – BALANCED 1-4

- Connect SUBWOOFER OUT BALANCED 1, BALANCED 2, BALANCED 3 and/or BALANCED 4 to the low level input of corresponding powered subwoofers.
- Low frequency information below the selected crossover setting is sent to the connected subwoofer.

14 POWER

- Supplies the AC mains power to the M66.
- When the rear panel POWER switch is switched ON, the unit will automatically turn ON (operating mode) - Status Indicator (NAD logo) will turn red, touch panel display will activate and then Status Indicator (NAD logo) will turn white. It is not necessary to press the front panel  (Standby) button.
- If you do not intend to use the M66 for long periods of time (such as when on vacation), switch off the POWER switch.
- With rear panel POWER switched off, neither the front panel  (Standby) button nor SRM1 remote control's [ON] button can activate the M66.

15 PHONO MC

- Input for a Moving Coil phono cartridge. Connect the twin RCA lead from your turntable to this input if you are using a Moving Coil cartridge.

16 PHONO GROUND CONNECTOR

- Turntables normally includes a single wire earth lead. Use the M66 phono ground connector to connect this lead.
- Unscrew the terminal to expose the hole, which will accept the lead. After insertion, tighten the terminal to secure the lead.

17 PHONO MM

- Input for a Moving Magnet phono cartridge. Connect the twin RCA lead from your turntable to this input if you are using a Moving Magnet cartridge.

18 LINE IN 1, IN 2

- Input for line level sources such as CD player, tuner or any compatible devices. Use dual RCA-to-RCA cable to connect the source device's left and right "Audio Output" to these line input ports.
- The sources will appear as "Line 1" and "Line 2" in the navigation drawer of the BluOS App.

19 BALANCED IN

- Connect XLR audio source to these connectors. Ensure that proper pin configurations are followed – Pin 1: Ground, Pin 2: Positive (signal live) and Pin 3: Negative (signal return).
- Digital audio stream from professional audio sources can be connected to this XLR connector. For high-end sources with higher sampling rates like 176kHz and 192kHz, it is highly recommended that such sources be interfaced with the AES/EBU IN connector. The AES/EBU IN is well suited to handle such sources with high sampling rate.
- The source will appear as "Balanced In" in the navigation drawer of the BluOS App.

20 ANALOG AUDIO OUTPUT (BALANCED)

- Use the ANALOG AUDIO OUTPUT (BALANCED) if the external source to be connected has BALANCED audio input.
- Superior audio quality is ensured with the distinctive noise reduction capability of BALANCED connection with XLR jacks.

21 ANALOG AUDIO OUTPUT (SINGLE-ENDED)

- Use single-ended ANALOG AUDIO OUTPUT (SINGLE-ENDED) for sources that are not equipped with BALANCED analog audio input.
- Use a twin RCA-to-RCA lead to connect ANALOG AUDIO OUTPUT (SINGLE-ENDED) to the corresponding analog audio input of compatible devices such as amplifiers, receivers or other applicable devices.

IMPORTANT

There is no audio output at ANALOG AUDIO OUTPUT (BALANCED and SINGLE-ENDED) if

- *Headphone is connected to HEADPHONES jack in the front panel.*
- *M66 is at Bluetooth Headphones mode.*

22 FUSE HOLDER

- Only qualified NAD service technicians can have access to this fuse holder. Opening this fuse holder may cause damage thus voiding the warranty of your M66.

IDENTIFICATION OF CONTROLS

SRM 1 REMOTE CONTROL

23 GROUND

- If a separate earth ground is necessary, use this terminal to ground your M66. The M66 can be connected to ground by connecting a ground lead wire or similar to this terminal. After insertion, tighten the terminal to secure the lead.

24 AC MAINS INPUT

- The M66 comes supplied with two separate mains power cords. Select the mains power cord appropriate for your region.
- Before connecting the power cord's plug to the mains power outlet, ensure that the other end of the power cord is firmly connected to M66's AC Mains input socket.
- Always unplug the power cord from the mains power outlet before disconnecting the other end of the power cord from M66's AC Mains input socket.

USING SRM 1 REMOTE CONTROL

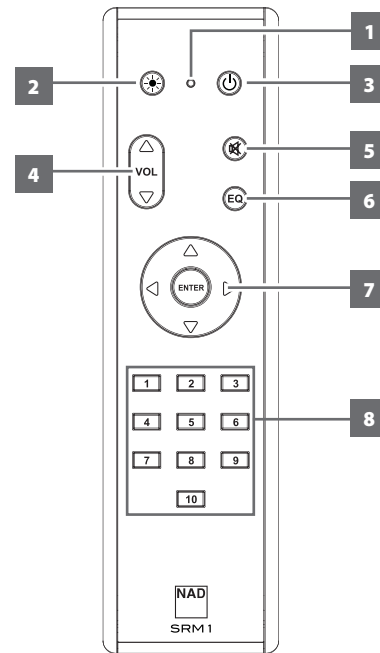

- LED indicator:** Blinks whenever a command is sent.
- ☀️:** Set indicator brightness level of Status Indicator (NAD logo)
- ⏻:** Switch from low power standby mode (no display, NAD logo lit) to operating mode and vice-versa.
- ▲VOL▼:** Increase or decrease volume level
- 🔇:** Temporarily switch off or restore audio. Press again or adjust Volume level to restore audio.
- EQ:** Not applicable for M66
- ▲/+, -/▼:** User defined. Function can be assigned via IR Learning.
 - ▶ Go to the next song/file
 - ◀ Go to the beginning or previous song/file
 - ENTER:** Start or pause playback
- 1 to 10 numbered buttons:** Select Preset number

The intuitive front panel display allows the user to perform and navigate through several functions, features and Sources of M66. Touch anywhere in the front panel display and below menu options will become available.

NAVIGATING THE FRONT PANEL DISPLAY ITEMS AND MAKING CHANGES

Use your finger to touch, swipe and navigate through the front panel display items. Touch or swipe (left, right, upwards or downwards) to select or configure an item.

SAMPLE DISPLAY SCREEN

NOW PLAYING

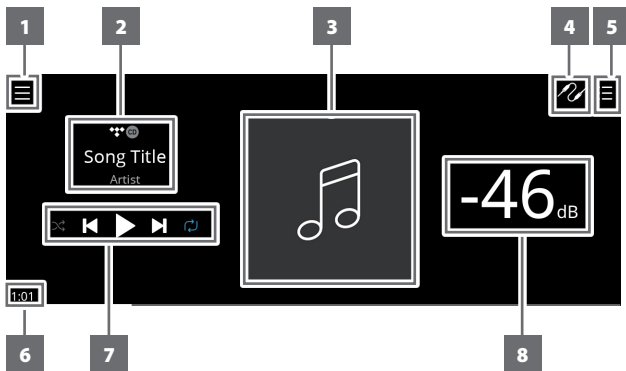

- 1 New screen is opened showing configurable Sources and Players menu options.
- 2 Information about album, artist and music name
Logo or icon for music service provider or media source input (analog, optical, coaxial, Bluetooth, HDMI eARC, etc.)
- 3 Album art cover
- 4 Source list is displayed where one can select desired Source to access or playback contents.

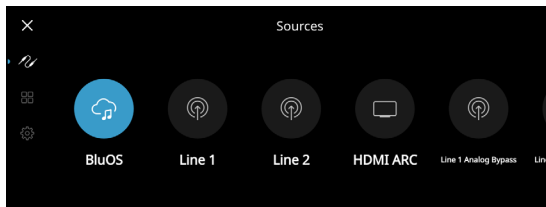

- 5 Display "Play Queue" that was setup via the BluOS App. "Play Queue" is a list of songs or tracks that are populated and put on queue via the BluOS App.

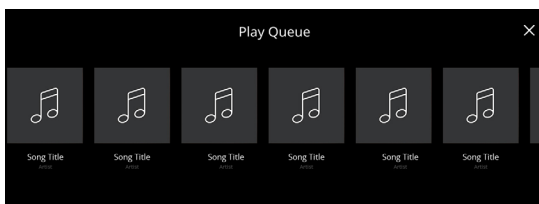

- 6 Elapsed playback time of current media
- 7 Playback controls for applicable media (song, title, file, music station and others)
 - ▶▶ Skip to next media
 - ▶|| Play or pause current media
 - ◀◀ Skip back to previous media
 - ◁/× Repeat and random mode controls are also available for selection
- 8 Volume level

FRONT VIEW

Now Playing display will switch to selected Front View default screen if there is no user interaction within 10 seconds. Front View display will remain until a user interface is made. Front View display can be configured via Settings-Source Setup-Sources menu.

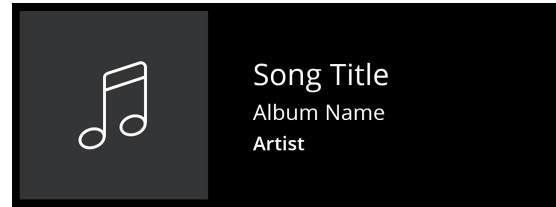

MENU OPTIONS

SOURCES

Select preferred Source to access or playback contents

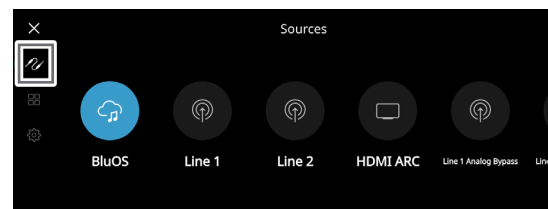

PRESETS

Use BluOS App to program into Presets your favourite radio stations, music streams, playlists or Sources

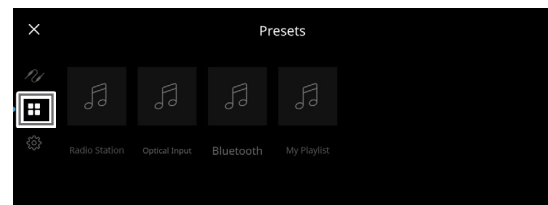
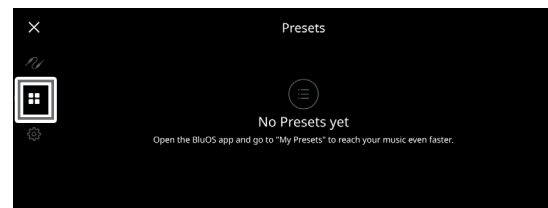

SETTINGS

Configure or display M66 settings

Player

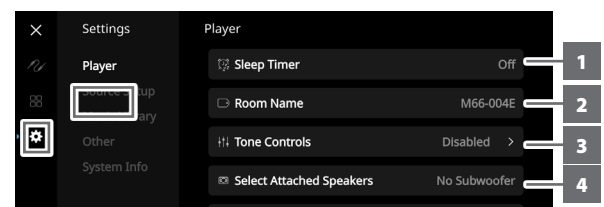

- 1 **Sleep Timer:** Stop playback after a set amount of time via gentle volume decline

OPERATION

USING THE FRONT PANEL DISPLAY

- Room Name:** Create a customized room name for the M66 using the pop up keyboard
- Tone Controls:** Swipe to boost or reduce Bass and Treble response. Tone Control levels, Bass and Treble, can be turned ON/OFF or

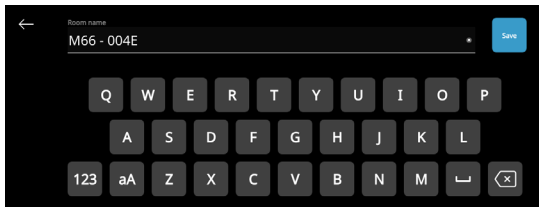

Reset.

- Select Attached Speakers:** Select corresponding option depending upon the number of subwoofers connected.

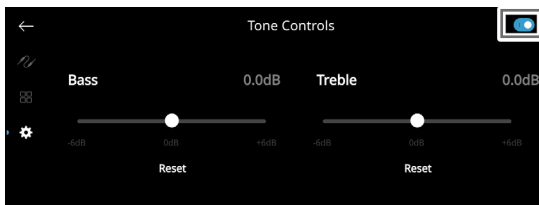
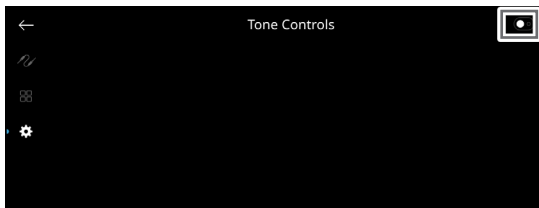

- Subwoofer** – A subwoofer is connected to rear panel Subwoofer Output port 1.
- Subwoofers** – A subwoofer is connected to each of the rear panel Subwoofer Output ports 1 and 2.
- Subwoofers** – A subwoofer is connected to each of the rear panel Subwoofer Output ports 1, 2 and 3.
- Subwoofers** – A subwoofer is connected to each of the rear panel Subwoofer Output ports 1, 2, 3 and 4.
- Crossover:** The subwoofer will reproduce only low frequency information below the selected crossover setting.
- Digital Dynamic Headroom:** With Digital Dynamic Headroom (DDH) enabled, digital inter-sample peak clipping distortion

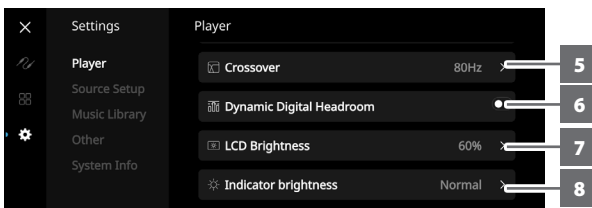

that can occur during digital-to-analog conversion with sudden high-frequency transients is eliminated. The benefits are especially noticeable with percussion instruments: rim shots are more impactful but less strident; cymbals are more realistic and less splashy.

- LCD Brightness:** Adjust the brightness level of the front panel display.
- Indicator Brightness:** Set indicator brightness level of Status Indicator (NAD logo). There are 3 brightness level options – Normal, Dim or Off.
Normal - Status Indicator (NAD logo) is at its brightest level.
Dim - Status Indicator (NAD logo) brightness level is less than normal level.
Off - Status Indicator (NAD logo) has no light.

- Dark Mode:** Background of Front View display for particular source is either dark (enabled) or bright (disabled).
- Amplifier Standby:** At enabled mode, unit will go into a low power standby mode (no display, NAD logo lit) after 15 minutes of no

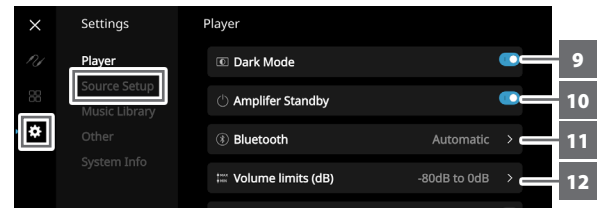

playback or user interface at the current Source. Touch the display panel, resume playback or rotate the Volume knob to switch the unit from low power standby mode to operating mode. At disabled mode, unit will not go to standby mode even if there is no playback or user interface at the current Source.

- Bluetooth:** Set Bluetooth connection to Manual, Automatic, Guest or Disabled.
- Volume Limits (dB):** Set volume range from lowest to highest level in dB units.
- LCD Temporary Display:** Enabled mode will turn off display temporarily after 1 minute of non-user interface. Touch front panel display to resume display. Disabled mode will keep display shown.
- Volume In Percent:** Volume level is displayed in percent when enabled. At disabled mode, volume level is displayed in dB.

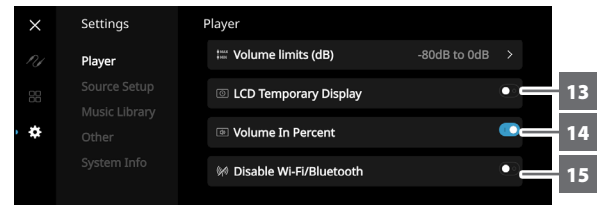

- Disable Wi-Fi/Bluetooth:** Enable to cutoff WiFi and Bluetooth connections. Disable for WiFi and Bluetooth connections to be reconnected or retain connections.

SOURCE SETUP

Select and configure Source

- Sources:** Select Source to configure
- Name:** Customize the Source's Name using the pop-up keyboard

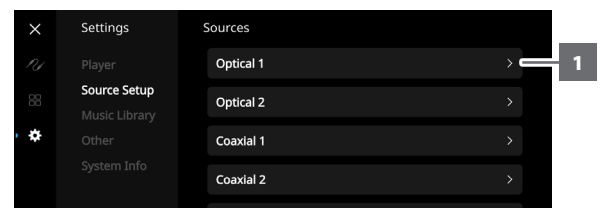

- Icon:** Select and assign icon for the selected Source

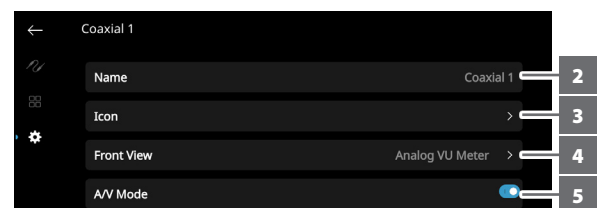

4 Front View: Front display layout and contents can be configured by

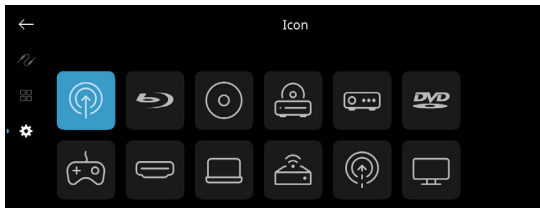

selecting the following options.

- Source (Simple), Source (Detailed)
- Analog VU meter, Digital VU.
- Album, Text and VU, Album and Text, Album Only and Text Only (applicable only to BluOS Source)

A combination of above options is available depending upon the Source selected.

Text Only

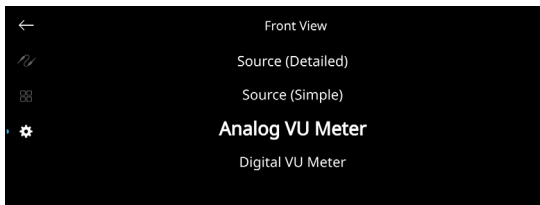

- Display album name, song title, artist name, broadcast/radio station, name, title of the show, etc.

Album Only

- Display album/title art, station ID symbol or icon only

Album and Text

- Display album/title art, station ID symbol, icon and other information like album name, song title, artist name, broadcast/radio station name, title of the show, etc.

Album, Text and VU

- Display all the information indicated above for Cover Art and Meta Data plus VU meter

Source (Simple)

- Display Source name only which is "BluOS" or name of Cloud or Radio Service

Source (Detailed)

- Display Source name or name of Cloud or Radio Service plus other information like volume level

Analog VU Meter

Digital VU Meter

- VU Meter monitors or reflects audio input level of current BluOS source. If "Mute" is enabled, the VU meter will not turn off or go to minimum level as it is the audio output that is muted.

5 MQA Pass-through (applies only to Coaxial and Optical Sources):

Enable MQA Pass-through for the M66 to act as MQA decoder or renderer when MQA certified CD player or other MQA certified devices are connected to coaxial or optical input ports. Disable AV Mode for MQA Pass-through to be enabled.

6 A/V Mode: By connecting your TV or other video sources to your M66 through analog, coaxial, optical or HDMI input ports, you can listen to your favorite shows or movies through your BluOS system. Grouping multiple BluOS devices from one of these inputs can require an abundance of network traffic. A/V mode creates a short and unobtrusive buffer to your audio to ensure your BluOS system stays in sync with your video even with slower or cluttered networks. When using coaxial and optical sources, MQA Pass-through must be disabled for A/V Mode to be enabled.

Enabled: With A/V Mode enabled on your input source, audio delay will be automatically adjusted to keep your grouped BluOS devices in sync with the video source connected. Use the Lip-sync delay slider to manually adjust the lower end of this delay to better suit the speed of your network.

Disabled: When your M66 is connected to an audio source without video, such as a turntable or CD player, the A/V Mode setting should be disabled.

7 Lip-sync delay: With A/V Mode enabled, "Lip-sync delay" can be adjusted to ensure your audio is staying in sync over your network with the original video source. By varying "Lip-sync delay" from 50ms to 150ms, one can delay the audio output to synchronize it with the video image of the corresponding source.

8 Hide Source: Activate or deactivate selected Source

9 Analog Direct (applies only to Phono MM, Phono MC, Line 1, Line 2 and Balanced Sources): With "Analog Direct" enabled, analog input signal will bypass all digital signal processing (Tone Controls, Dirac, Bass Management, etc.). The Balanced input will remain balanced all the way through to the Balanced output. The unbalanced inputs (phono MM/MC, Line 1,2) are converted to balanced right at the input.

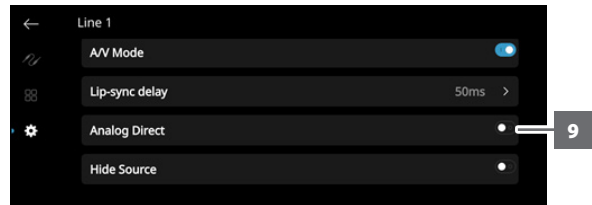

MUSIC LIBRARY

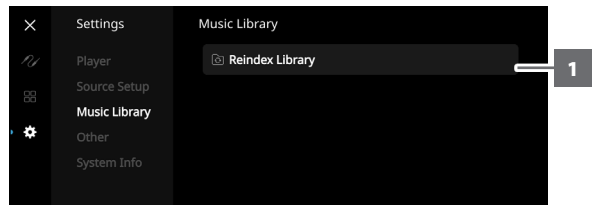

1 Reindex Library: Music library will be scanned for any newly added, deleted, or updated files, ensuring that these changes are incorporated into the BluOS Controller app.

OTHER

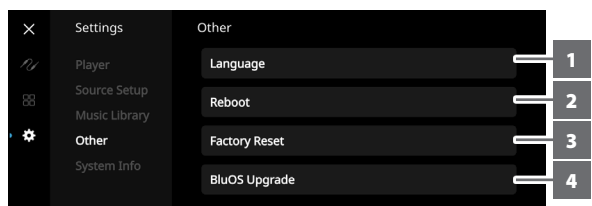

1 Language: Select available language. The screen display will be shown in the language selected.

2 Reboot: Cycle power by powering off and powering back the unit.

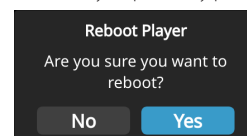

3 Factory Reset: Restore to factory default settings

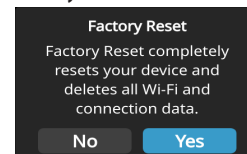

OPERATION

OTHER FUNCTIONS AND FEATURES

- BluOS Upgrade:** Select "BluOS Upgrade" to initiate BluOS upgrade mode. When "BluOS Upgrade" prompt appears, select "Yes" to start BluOS upgrade process. Follow the display screen prompt to complete the upgrade procedure.



SYSTEM INFO

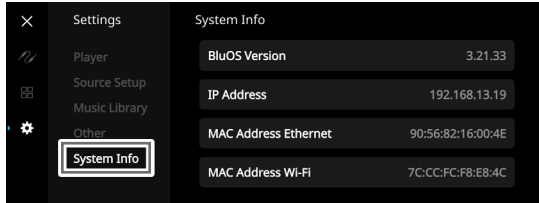

Display information about the following parameters

- Show current or detected information about **BluOS firmware version**, **IP Address**, **MAC Address Ethernet** and **MAC Address Wi-Fi**.

BLUETOOTH HEADPHONE/SPEAKER PAIRING

Bluetooth headphones/speakers can be paired to your M66 using the BluOS Controller App.

CONNECT

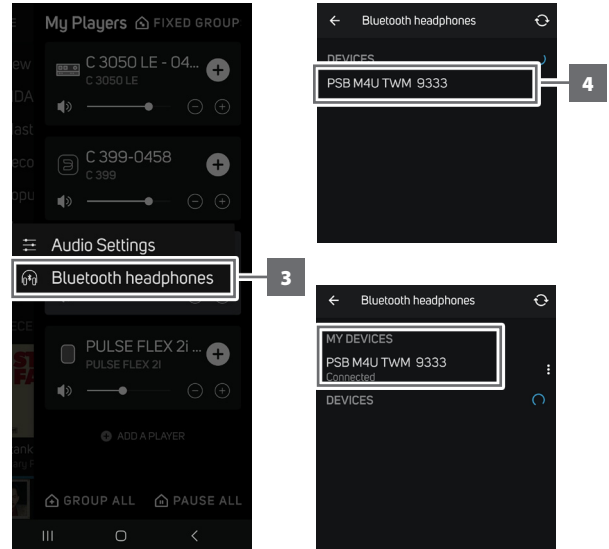
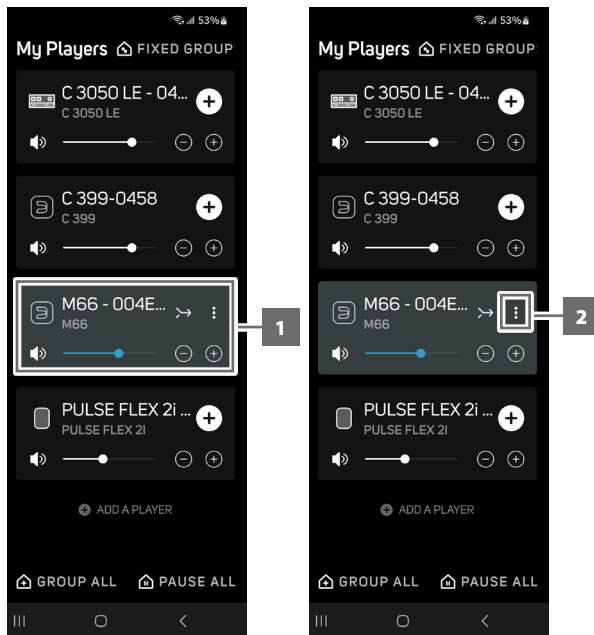

DISCONNECT/FORGET DEVICE

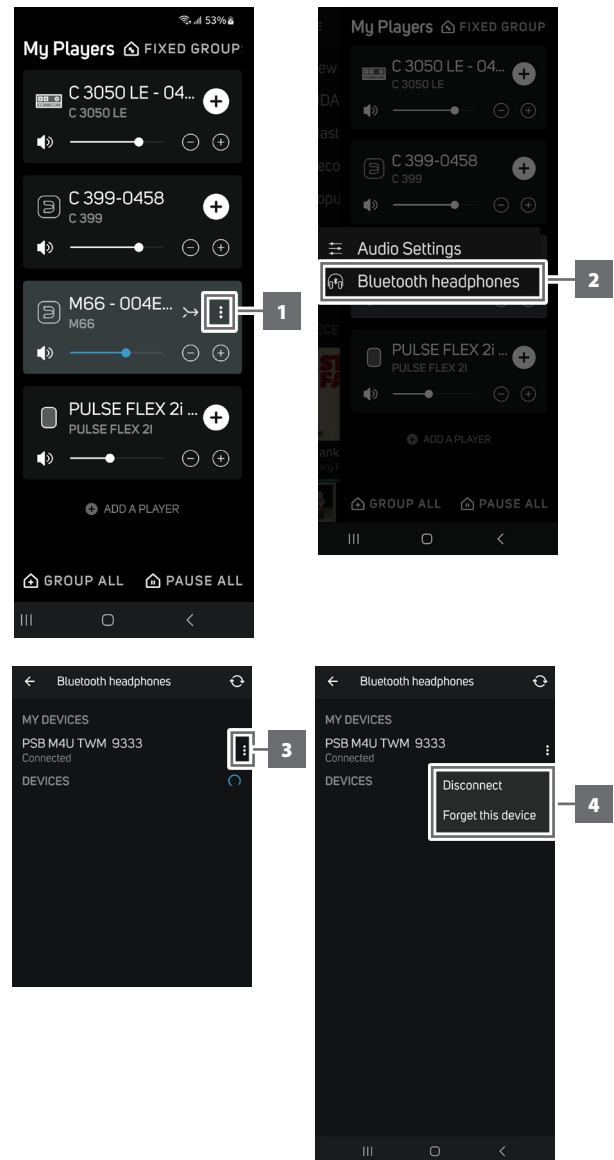

MASTER QUALITY AUTHENTICATED

M66 includes powerful decoder and audio renderer for the MQA system. This ensures that MQA-encoded audio files

sound exactly like the source. M66 playback and decodes MQA content from BluOS sources. MQA indicators are both shown in the front panel display and in the BluOS app.

DIRAC LIVE FULL FREQUENCY AND DIRAC LIVE BASS CONTROL

The M66 integrates Dirac Live Full Frequency and Dirac Live Bass Control. Connect the supplied calibrated microphone to the M66's USB port and then launch the Dirac Live app on a smart device or personal computer. The app will walk you through the calibration process, and then generate correction filters that compensate for acoustic problems like standing waves and unwanted reflections. You'll enjoy more textured bass, improved tonal accuracy, vastly improved clarity, and more focused imaging.

In a first for a stereo component, the M66 features four balanced and four single-ended subwoofer outputs and integrates Dirac Live Bass Control, which allows independent calibration of multiple subwoofers. Dirac Live Bass Control optimizes subwoofer output in both the frequency and time domains, achieving a seamless blend between the subwoofer(s) and main speakers, and delivering smooth, consistent bass response through the entire listening area, not just in the sweet spot.

MAKING THE MOST OF YOUR M66

Download the BluOS Controller App from the respective App stores of Apple iOS devices (iPad, iPhone and iPod), Android devices, Kindle Fire and Windows or Mac desktops.

Launch the BluOS Controller App and explore everything from your streaming music services, internet radio stations, networked music collections and favorites with quick and easy single-search discovery.

Visit support.bluos.net for more information about setup and operation guidelines of your M66.

REFERENCE

SPECIFICATIONS

All specs are measured according to IHF 202 CEA 490-AR-2008 standard. THD is measured using AP AUX 0025 passive filter and AES 17 active filter.

PREAMPLIFIER SECTION

LINE IN, SINGLE-ENDED ANALOG AUDIO OUTPUT

THD (20 Hz – 20 kHz)	<0.001 % at 2V out
Signal-to-Noise Ratio	>105 dB (IHF; A-weighted, ref. 500 mV out, unity gain)
Channel separation	>120 dB (1 kHz) >108 dB (10 kHz)
Input impedance (R and C)	56 kohms + 100 pF
Maximum input signal	>5.6 Vrms (ref. 1% THD) >8 Vrms (bypass, ref. 1% THD)
Output impedance	Source Z + 22 ohms
Input sensitivity	185 mV (ref. 500 mV out, Volume maximum)
Frequency response	±0.2 dB (20 Hz - 20 kHz) ±0.2 dB (bypass, 20 Hz - 80 kHz)
Maximum voltage output -IHF load	>5 V (ref. 0.1 % THD) >10 V (bypass, ref. 0.1 % THD)

BALANCED IN, BALANCED ANALOG AUDIO OUTPUT

THD (20 Hz – 20 kHz)	<0.001 % at 2V out
Signal-to-Noise Ratio	>105 dB (IHF; A-weighted, ref. 500 mV out, unity gain)
Channel separation	>120 dB (1 kHz) >120 dB (10 kHz)
Input impedance (R and C)	56 kohms + 100 pF
Maximum input signal	>5.6 Vrms (ref. 1% THD) >8 Vrms (bypass, ref. 1% THD)
Output impedance	Source Z + 22 ohms
Input sensitivity	92.5 mV (ref. 500 mV out, Volume maximum)
Frequency response	±0.2 dB (20 Hz - 20 kHz) ±0.2 dB (bypass, 20 Hz - 80 kHz)
Maximum voltage output -IHF load	>10 V (ref. 0.1 % THD) >20 V (bypass, ref. 0.1 % THD)

DIGITAL SOURCE IN, SINGLE-ENDED ANALOG AUDIO OUTPUT

THD (20 Hz – 20 kHz)	<0.0005 % at 2V out
Signal-to-Noise Ratio	>108 dB (IHF; A-weighted, ref. 500 mV out, unity gain)
Channel separation	>126 dB (1 kHz) >115 dB (10 kHz)
Input sensitivity	-20.25 dBFS ref. 500 mV out (-6 dBV), Volume maximum
Frequency response	±0.2 dB (20 Hz - 20 kHz)
Maximum voltage output -IHF load	>5 V (ref. 0.1 % THD)

DIGITAL SOURCE IN, BALANCED/ANALOG AUDIO OUTPUT

THD (20 Hz – 20 kHz)	<0.0005 % at 2V out
Signal-to-Noise Ratio	>108 dB (IHF; A-weighted, ref. 500 mV out, unity gain)
Channel separation	>126 dB (1 kHz) >115 dB (10 kHz)
Input sensitivity	-26.25 dBFS ref. 500 mV out (-6 dBV), Volume maximum
Frequency response	±0.2 dB (20 Hz - 20 kHz)
Maximum voltage output -IHF load	>10 V (ref. 0.1 % THD)

LINE IN, SINGLE-ENDED SUBWOOFER OUTPUT/2SUBWOOFERS

THD (20 Hz – 20 kHz)	<0.005 % at 2V out
Signal-to-Noise Ratio	>80 dB (IHF; A-weighted, ref. 500 mV out, unity gain)
Output impedance	480 ohms
Maximum voltage output -IHF load	>5 V (ref. 0.1 % THD)

BALANCED IN, BALANCED SUBWOOFER OUTPUT/2SUBWOOFERS

THD (20 Hz – 20 kHz)	<0.005 % at 2V out
Signal-to-Noise Ratio	>80 dB (IHF; A-weighted, ref. 500 mV out, unity gain)
Output impedance	480 ohms
Maximum voltage output -IHF load	>10 V (ref. 0.1 % THD)

PHONO INPUT, SINGLE-ENDED ANALOG AUDIO OUTPUT (Analog bypass)	
THD (20 Hz – 20 kHz) at 2 V out	MM<0.008% MC<0.02%
Signal-to-Noise Ratio (A-weighted, ref. 500 mV out)	MM>82dB MC>75dB
Input Impedance (R and C)	MM: 56 kohms/100 pF MC: 100 ohms/280 pF
Input sensitivity (ref. 500 mV out, Volume maximum)	MM: 1.7 mV MC: 123 µV
Frequency response	±0.2 dB (20 Hz - 20 kHz)
Maximum input signal at 1kHz (ref. 0.1 % THD)	MM>80 mVrms MC>7 mVrms

PHONO INPUT, SINGLE-ENDED ANALOG AUDIO OUTPUT (Analog bypass)	
THD (20 Hz – 20 kHz)	<0.002% at 1V out
Signal-to-Noise Ratio	>98 dB (32 ohms loads; A-WTD, ref. 0.5V out, unity gain)
Frequency response	±0.3 dB (20 Hz - 20 kHz)
Channel separation	>62 dB at 1kHz
Output impedance	Source Z + 4.7ohms
Power consumption	
- Amplifier Standby ON, Network Standby mode	8W
- Amplifier Standby ON, Deep Standby mode	0.5

BLUOS SECTION

AUDIO	
Supported Audio File Formats	MP3, AAC, WMA, WMA-L, OGG, ALAC, OPUS
Supported Hi-Res Audio File Formats	FLAC, MQA, WAV, AIFF, MPEG-4 SLS
Sampling Rates	up to 192kHz
Bit depths	16 – 24

CONNECTIVITY	
Network connectivity	Ethernet RJ45, Gigabit 1000 Mbps Wi-Fi 5 (802.11ac), dual-band
Bluetooth codec	Bluetooth 5.0 aptX HD
Bluetooth connectivity	Two-Way (Receive and Headphone modes)
USB	Type A (FAT 32 formatted)

USER INTERFACE	
Supported operating system	Music playback from network shares on the following desktop operating systems: Microsoft Windows XP, 2000, Vista, 7, 8 to current Windows Operating Systems and macOS versions **
Mobile Application	Free BluOS Controller App available for download from the respective App stores of Apple iOS devices (iPad, iPhone and iPod), Android devices, Kindle Fire and Windows or macOS desktops
Front panel	7-inch full colour touch screen
Remote control	SRM1 remote control

SUPPORTED SERVICES***	
Music services	Amazon Music, Bugs, CustomChannels, Deezer, IDAGIO, KKBOX, Napster, Neil Young Archives, nugs.net, Qobuz, QPlay, Qsic, SOUNDMACHINE, Spotify, TIDAL, Tunisty
Free internet radio	Calm Radio, SiriusXM, iHeartRadio, LiveXLive, RADIO.COM, Radio Paradise, Tuneln
Integration services	Control 4, Crestron, ELAN, Lutron, Push, Roon, RTI, URC
Digital Assistant	Amazon Alexa, Siri

DIMENSION AND WEIGHT	
Box size (H x W x D) ****	569 x 519 x 258 mm
Gross weight	16.3 kg (35.8 bs)

* - After 15 minutes of no user interface interaction and no active source input
 ** - With established wired or wireless network connection, wireless Bluetooth connectivity and no user interface interaction and no active source input for 15 minutes
 *** - Some supported services are not available in all geographic regions due to copyright laws and licensing agreements. Check supported services availability in your area or region.
 **** - Gross dimension includes feet, volume knob and extended rear panel terminals.

Specifications are subject to change without notice. For updated documentation and features, please check out www.NADelectronics.com for the latest information about M66.



www.NADelectronics.com

**©2024 NAD ELECTRONICS INTERNATIONAL
A DIVISION OF LENBROOK INDUSTRIES LIMITED**

All rights reserved. NAD and the NAD logo are trademarks of NAD Electronics International, a division of Lenbrook Industries Limited.
No part of this publication may be reproduced, stored or transmitted in any form without the written permission of NAD Electronics International.
While every effort has been made to ensure the contents are accurate at the time of publication, features and specifications may be subject to change without prior notice.

M66 OM V14 - MAR 2024