

T+A

USER MANUAL

K2 Blu

Welcome.

We are delighted that you have decided to purchase a **T+A** product. With your new **K2 Blu** you have acquired a top-quality piece of equipment which has been designed and developed with the wishes of the audiophile music lover as absolute top priority.

This system represents our very best efforts at designing practical electronic equipment incorporating solid quality, user-friendly operation and a specification and performance which leaves nothing to be desired.

All these factors contribute to a piece of equipment which will satisfy your highest demands and your most searching requirements for a period of many years. All the components we use meet the German and European safety norms and standards which are currently valid. All the materials we use are subject to painstaking quality monitoring.

Our robust all-metal cases exclude any possibility of external sources of interference affecting the quality of reproduction. From the opposite point of view our products' electro-magnetic radiation (electro-smog) is reduced to an absolute minimum by the outstandingly effective screening provided by the metal case.

All sub-assemblies and mains sections are designed to be extremely efficient. A European EUP directive will come into force in future, relating to energy efficiency and the avoidance of greenhouse gases which are harmful to the climate; the directive's requirements will be very stringent, but our equipment satisfies them in full even today.

Our range of accessories includes high-quality cables and connectors.

We would like to take this opportunity to thank you for the faith you have shown in our company by purchasing this product, and wish you many hours of enjoyment and sheer listening pleasure with your **K2 Blu**.

T+A elektroakustik GmbH & Co KG



Manufactured under license from Dolby Laboratories.

"Dolby" and the double-D Symbol are trademarks of Dolby Laboratories.



"DTS" and "DTS Digital Surround" are trademarks of Digital Theater Systems, Inc.

Manufactured under license from one or more of the following DTS, Inc. U.S. Pat. No's: 5,451,942; 5,956,674; 5,974,380; 5,978,762; 6,487,535 and other U.S. and world-wide patents issued and pending. "DTS" is a registered trademark of DTS, Inc. and "DTS 2.0 + Digital Out" is a trademark of DTS, Inc. Copyright 1996, 2002-2006 DTS, Inc. All rights Reserved.



"iPod is a trademark of Apple Inc., registered in the U.S. and other countries."

"Made for iPod" means that an electronic accessory has been designed to connect specifically to iPod and has been certified by the developer to meet Apple performance standards.

Apple is not responsible for the operation of this device or its compliance with safety and regulatory standards.

About these instructions

The **K2 Blu** is available in two versions: the **K2 Blu** with Streaming Client module, and the **K2 Blu** without network capability; these instructions apply to both versions. The 'Streaming Client' chapter and the network settings are irrelevant to the **K2 Blu** model.

The **K2 Blu** amplifier, with its five output stages, can be used in various ways: it can provide sound to two associated zones in a single room, or to two separate rooms.

It is also possible to use the **K2 Blu**'s integral output stages for audiophile bi-amping. For more details on these possible modes of operation please refer to the appropriate chapters.

All the controls and functions of the **K2 Blu** which are frequently used are described in the first section of these operating instructions.

The second part - '**Basic settings, Installation, Using the system for the first time**' covers connections and settings which are very seldom required; they are generally required only when the machine is set up and used for the first time. Here you will also find a detailed description of the network settings required for connecting the **K2 Blu** to your home network.

For newcomers to networks we have prepared explanations of some of the important terms used in this technology and other background information in the Chapter '**Network Terminology**'.



All the components we use meet the European safety norms and standards which are currently valid. The operation instructions, the connection guidance and the safety notes are for your own good - please read them carefully and observe them at all times.

This product complies with the Low Voltage Directive (73/23/EEC), EMV Directives (89/336/EEC, 92/31/EEC) and CE Marking Directive (93/68/EEC).

Contents

	Page
Operation	
Controls	4
Remote control	8
Basic functions of the K2 Blu	11
Switching sources	11
Volume adjustment	11
Mode of operation	12
Tone settings (Tone menu)	13
System settings (System configuration menu)	14
Alarm timer	19
Alarm timer menu	19
Operating the source devices in detail	21
Operating the radio	21
Operating the disc player (media player)	23
Disc Player setup menu (Blu-ray player configuration)	38
Operating the Streaming Client	48
Access to media content via the main menu (Home menu)	49
Access to media content via the Favourites list	50
Operating an iPod	51
Operating the Bluetooth source	53
Connections, using the system for the first time	
Connections	56
Listening zones and bi-amping	58
Set-up and wiring	59
Safety notes	61
FCC Information to the user	62
Network configuration	63
The vTuner Premium service	68
FD 100 Radio Remote Control	70
T+A TV Connect	72
Activating optional functions	72
Miscellaneous	
Trouble-shooting	73
Network terminology	80
Notes on Energy Saving	82
Appendix	
Wiring diagram	84
Specification	86

Symbols used in these instructions



Caution!

Text passages marked with this symbol contain important information which must be observed if the machine is to operate safely and without problems.



This symbol marks text passages which provide supplementary notes and background information; they are intended to help the user understand how to get the best out of the machine.

K2 Blu Multi Source System

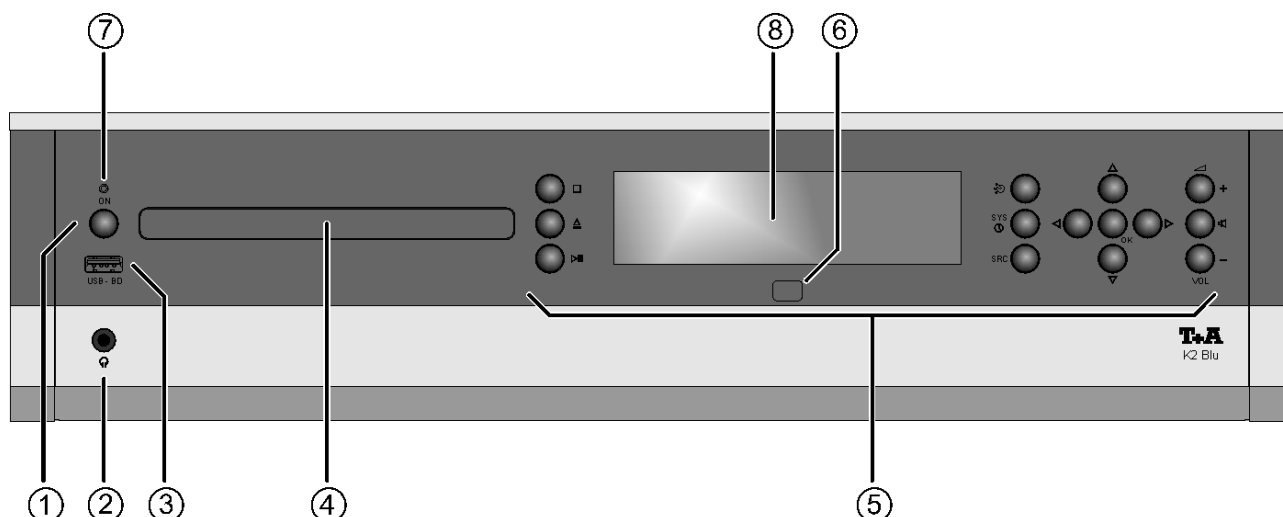

Controls

All the **K2 Blu**'s important functions can be operated using the buttons on the machine's front panel. Direct operating buttons are provided for basic functions such as selecting sources and tracks, whereas more rarely required functions are controlled by means of menus which are called up using the **SRC** and **SYS / Ⓞ** buttons.

The integral screen constantly displays all the information relating to the machine's current state, the track currently playing and the radio station currently tuned. The main item of information is emphasised on the screen in a context-sensitive manner, so that you can see it clearly from a distance. The following section describes the functions of the front panel buttons and the screen information in greater detail.

On / Off switch



(On and Off switch)

A brief press on the **ON** button switches the machine on and off.



Caution!

The mains button is not an isolation switch. Certain parts of the machine remain connected to mains voltage even when the screen is switched off and dark. If you know you will not be using the machine for a long period, we recommend that you disconnect it from the mains by withdrawing the mains plug from the wall socket.

Please see the chapter entitled 'Notes on Energy Saving' for details of power consumption.

Front panel connections



Socket for stereo headphones with a minimum impedance of 50 Ω.

When headphones are plugged in, the loudspeakers connected to the K2 Blu for the primary room (listening zone 1) are automatically switched off.



Note regarding the use of headphones



Continuous listening to programme material at very high volume using headphones or earphones can result in permanent loss of hearing. You can avoid subsequent health problems by avoiding continuous listening at high volume through headphones or earphones.



Socket for a USB memory stick.

This USB port can be used to reproduce **audio and video files**. The method of operation is described in the chapter entitled 'Operating the disc player (Media Player)'.

The storage medium must be formatted using the FAT16 or FAT32 file system. The USB memory can be powered via the USB port provided that its current drain is in accordance with the USB norm (< 500 mA).

- ④ Disc drawer The drawer is opened and closed by pressing the  button. Alternatively the drawer can be opened with a long press on the  button on the remote control handset, and closed again by pressing the  button on the handset.

Operating buttons ⑤



Source select

Pressing this button selects the desired listening source. Press the button repeatedly until the desired listening source appears on the screen.

The signal generated by the selected source can now be reproduced via the loudspeakers. The signal is also present at the **TAPE-OUT** output sockets for recording.

Disc mechanism functions



STOP / OPEN

Button for opening and closing the disc drawer.



STOP

Ends playback



PLAY / PAUSE

Starts playback

Halts current playback (pause)

Resumes playback after a pause

Menu functions



Source menu

Brief press: opens the menu for the selected source (DVD/Blu-ray track menu, Tuner menu, etc.)

A long press opens the Setup menu for the following sources:

Source	Setup menu
Streaming Client:	network setup (see chapter 'Network configuration')



System menu/
Alarm Timer

Brief press: opens the '**System Configuration**' menu (for further details see the chapter entitled '**System settings**')

Long press: opens the alarm timer menu (see chapter entitled '**Alarm Timer**')



Returns to the previous point / change button



Confirms the input / change button



Selects the next point within a list / select button



Selects the previous point within a list / select button



Confirm / select button in menus and lists

A brief press selects the highlighted menu point / list point

Loudspeaker / Volume



Switches the loudspeaker output on and off:

If speakers are connected to loudspeaker output B, you can cycle through the following modes of operation by repeatedly pressing this button:

Brief press: loudspeaker group A → B* → A+B*
* only if loudspeakers B are connected

Long press: Switches the loudspeakers off

A brief press on the  button terminates muting.



Increases / reduces volume

Display elements / Remote control receiver

- ⑥ **Remote control receiver** (below the screen)

i When using the remote control system please point the **FM100** handset in the direction of the receiver.
The line of sight between the FM100 and the remote control receiver in the **K2 Blu** must not be interrupted by any obstacles. Installing the K2 Blu behind the glass doors of a cabinet will also adversely affect the remote control system. It is essential to prevent potentially interfering light (from fluorescent lamps and energy-saving bulbs) falling directly on the receiver, as this may markedly reduce the effective range of the remote control system.

- ⑦ **Status LED** The Status LED glows in different colours to indicate various operating states. These are as follows:

LED colour	State	Note
off	Stand-by	Alarm timer operation possible
red	Energy saver off (Comfort stand-by)	Clock display and on / off switching possible using the FD 100
blue	Energy saver off (Comfort stand-by)	Alarm timer is programmed
white	Switched on	Flashes when the machine has been switched on by the alarm timer
green	Switched off	Only in two-room operation when loudspeakers B are switched on

- ⑧ **Display** The graphic screen of the **K2 Blu** displays all information regarding the status of the machine, the music track currently being played and the radio station currently tuned. The display is context-sensitive and varies according to the capabilities and facilities of the service or medium to which you are currently listening.

The most important information is highlighted on the screen in a context-sensitive manner. Supplementary information is displayed above and below the main text, or by means of symbols. The symbols used are listed and explained in the table below.

The screen can display the time of day in standby, if the energy saver is switched off, and is dimmable (variable brightness); it can therefore be adjusted to suit your personal preference and requirements. (see chapter '**System settings (System configuration menu)**')

e.g.

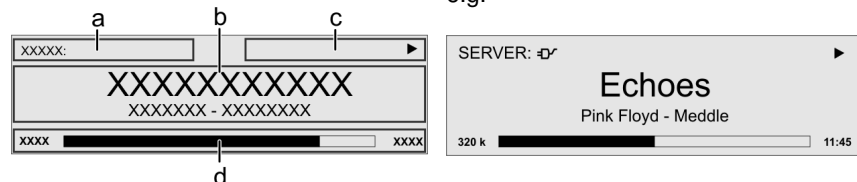

The displays and symbols which appear on the screen vary according to the currently active function (SCL, Disc, etc.) and the type of music currently being played.

The basic areas of the screen:















- Display field (a) shows the currently active source.
- Display field (b) shows information relating to the piece of music being played. The essential information is displayed enlarged in the main line.
- Display field (c) shows information relating to the device and playback.
- The bottom line (d) displays supplementary context-sensitive information (e.g. bitrate, elapsed time, state of reception)

i The **K2 Blu** provides different screen displays for the Streaming Client and the radio.

- **Large-format display:**
Enlarged display of the most important information, clearly legible even from a distance
- **Detail display:**
Small-text display showing a large number of additional information points, e.g. bit-rate etc.

A long press on the  button on the remote control handset is used to switch between the display modes.

Screen symbols and their meaning

	Making connection (Wait / Busy) The rotating symbol indicates that the K2 Blu is currently processing a command, or is attempting to connect to a service. These processes may take some time to complete depending on the speed of your network and the load upon it. During such periods the K2 Blu may be muted, and may not respond to the controls. Please wait until the symbol disappears, then try again.
	Indicates a music track which can be played , or a playlist .
	Indicates a folder which conceals further folders or lists.
	Indicates that a source is being reproduced via a cable connection .
	Indicates that a source is being reproduced via a radio connection .
	Indicates that the K2 Blu is reproducing a station or playing back a music track.
	Pause indicator
	Indicates that the speakers A and B are switched off. (in 2-zone mode only if speakers A are switched off)
128 k  	Buffer display (fullness indicator, memory display) and data rate indicator (if available): The higher the data rate, the better the quality of reproduction.
 1:20	Display of the elapsed playback time. This information is not available for all services.
	Indicates that the  button can be used to switch to a higher menu or select level.
0 / 0	Position indicator in select lists. The first number shows the current position in the list, the second number the total number of list entries (length of list).
	Indicates that the selected menu point or list point can be activated by pressing the  button.
ABC or 123 or abc	Display of the symbol input modes

Remote control

Introduction





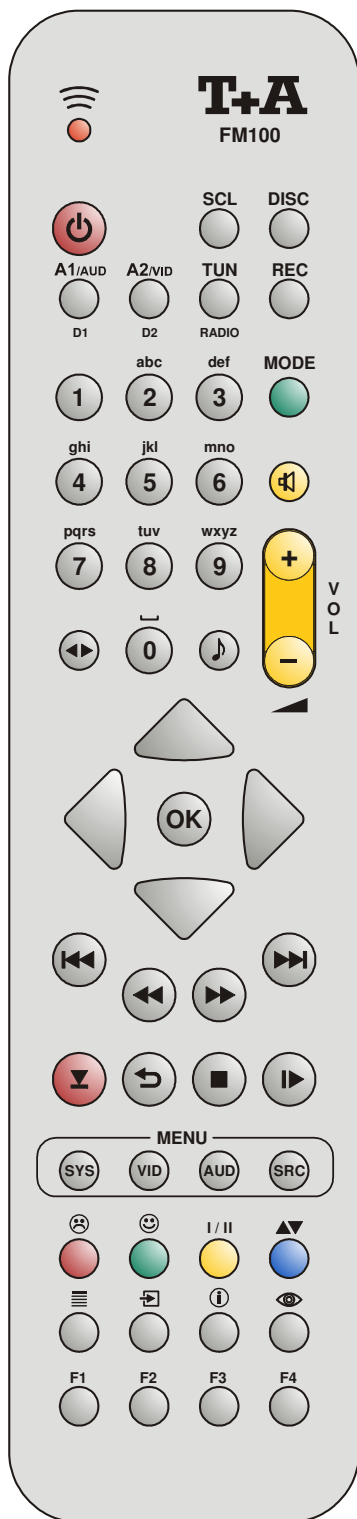

In general terms the function of the buttons on the remote control handset is the same as the corresponding buttons on the machine's front panel.









The Infra-Red sensor for the remote control system is located within the screen area of the **K2 Blu**. There must be unobstructed line of sight between the **FM100** and the machine's integral screen.













The following tables show the remote control buttons and their function when operating the machine.



	Switches the device on and off
	Direct source select buttons
	Brief press: selects the K2 Blu 's Streaming Client function (Internet radio, access to music server) Long press: selects the iPod as source device
	Selects the K2 Blu 's disc player as source device
	Repeatedly pressing the button selects the following sources on the K2 Blu : <i>AUX IN, DIG IN 1, DIG IN 2, Bluetooth.</i>
	Brief press: TV input of the K2 Blu
	Brief press: Radio function of the K2 Blu
	Brief press: Recorder input (TAPE) of the K2 Blu
	Direct alpha-numeric input, e.g. track number, quick station select, radio station
	Special characters are also assigned to the and buttons.
	During the text input process it is possible to switch between numerical and alpha-numeric input, and between capital and lower-case letters, using the button.
	Switching between the following modes of operation: STEREO, 3-channel MUSIC, 3-channel MOVIE, VIRTUAL SURROUND.
	Brief press: Switches the loudspeakers on in turn: $A \rightarrow B^* \rightarrow A+B^*$ * only if loudspeakers B are connected Long press: Mute A brief press on the button terminates muting.
	Reduces / increases volume (volume control rocker)
	Tone settings A brief press opens the menu for altering the tone settings: Treble / Bass / Loudness / Balance / Fader / Center / Sub-woofer / Sound (sound fields) The menu points are called up using the / buttons, and can then be altered using the / buttons. For a more detailed explanation please refer to the chapter entitled 'Tone settings' (TONE menu).

	Radio	Streaming Client	Disc-Player	iPod
Navigation buttons				
	Back to the previous point	Back to the previous point During alpha-numeric character input the  button can be used to erase a character.	Cursor movement left	Back to the previous point
	Confirms the input	- Opens a folder - Starts a piece of music - Selects an Internet station	Cursor movement right	Confirms the input
	Selects the previous point within a list	Selects the previous point within a list	Cursor movement up	Selects the previous point within a list
	Selects the next point within a list	Selects the next point within a list	Cursor movement down	Selects the next point within a list
	Confirmation button during input procedures	Confirmation button during input procedures Opens a folder, starts a piece of music, selects an Internet station.	Confirmation button during input procedures	Confirmation button during input procedures

Disc mechanism control				
		Selects the previous piece in the playlist	Rewind / fast forward to search for a particular passage	Selects the previous piece in the playlist
 	Brief press: manual fine-tuning Long press: Search	Rewind / fast forward to search for a particular passage	Rewind / fast forward to search for a particular passage Repeatedly pressing this button varies the search speed. The search is terminated by pressing the  button.	Rewind / fast forward to search for a particular passage
		Selects the next piece in the playlist	Selects the next track during playback	Selects the next piece in the playlist
 (REPEAT)		Repeat function (see the chapter <i>'Operating the Streaming Client'</i>)	Repeat function (see the chapter <i>'Operating the Blu-ray disc player'</i>)	Repeat function (see the chapter <i>'Operating the iPod'</i>)
 (STOP)		Terminates playback	Brief press: halts playback Long press: opens and closes the CD drawer in STOP mode	Terminates playback and unloads the playlist
 (PLAY/ PAUSE)	Selects station from the Favourites list	<ul style="list-style-type: none"> Starts playback of titles / folders (Play function) During playback: halts playback (Pause) or resumes playback 	<ul style="list-style-type: none"> Starts playback (Play function) During playback: halts playback (Pause) or resumes playback 	<ul style="list-style-type: none"> Starts playback (Play function) During playback: halts playback (Pause) or resumes playback

	Radio	Streaming Client	Disc-Player	iPod
Menu functions				
	Opens the System configuration menu (e.g. for adjusting screen brightness)			
	Opens the Favourites menu if the Favourites list is currently displayed	Brief press: switches to the main (Home) menu Long press: opens the Network Configuration menu	Brief press: opens the Disc menu	
Special functions				
	Long press: Removes a favourite from a station list	Long press: Removes a favourite from the Favourites list created on the K2 Blu	Red button in menus	
	Adds a favourite to the Station list	Adds a favourite to the Favourites list created on the K2 Blu	Green button in menus	
	Button for switching between Stereo reception (display ) and Mono reception (display )		Yellow button in menus	
		During character input: Repeated presses switch between numerical and alpha-numeric input, and between capital and lower-case letters In lists: Search function (alpha search)	Blue button in menus	
	Displays the Favourites list	Displays the Favourites list created on the K2 Blu	BD / DVD only During playback: selects the sub-title language and / or switches sub-titles on and off.	
	Memory button for quick station select	Memory button for quick station select	BD / DVD only: Switches between soundtracks present on the disc	
	Long press: Switches between different screen displays	Toggle switch between display of current music track and list navigation Long press: Switches between different screen displays	Superimposed information	
	Switches the radiotext function on and off.		DVD only: if the angle symbol is displayed: switches between different camera angles	
			Selects the audio track	Shuffle function (see chapter ' Operating the iPod ')

Basic functions of the K2 Blu





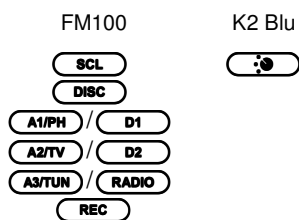











This chapter describes the basic functions of the **K2 Blu**, which are always available, regardless of the currently selected source.

Source switching



The desired source is selected by pressing the source button  on the front panel, repeatedly if necessary.

The source buttons on the FM100 remote control handset can be used to select the desired listening source as follows:



Streaming Client	brief press on the  button
iPod	long press on the  button
Disc Player	brief press on the  button
TAPE input	brief press on the  button
Radio input	brief press on the  /  button
TV IN input	brief press on the  /  button
AUX IN input	press the  /  button repeatedly if necessary
DIG IN 1 input	press the  /  button repeatedly if necessary
DIG IN 2 input	press the  /  button repeatedly if necessary
Bluetooth input	press the  /  button repeatedly if necessary

Once you have switched the **K2 Blu** to the desired source, you can listen to that source and also record the signal using the recorder outputs (TAPE OUT).

Internal sources, iPods connected to the **K2 Blu** and source devices connected via the **T+A E LINK** system, can be controlled using the FM100 remote control handset or the front panel buttons, provided that they are selected as the current listening source. For details on operating the **K2 Blu**'s integral source devices please refer to the following chapters.

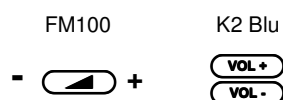
Volume control



The volume of the **K2 Blu** can be adjusted in fine increments using the  /  buttons on the machine's front panel, or -  + rocker on the remote control handset. A brief press of one of the volume buttons increases or reduces the volume level by one increment. Holding one of the volume buttons pressed in changes the volume level continuously.

Mode of operation

FM100

K2 Blu

MODE
(green)

The mode of operation for loudspeaker group A can be selected using this button. The available modes are **STEREO** and **VIRTUAL SURROUND**. If your system includes a Centre loudspeaker, the three-channel modes **3-channel MUSIC** and **3-channel MOVIE** are also available.

The first press on the **MODE** button displays the mode of operation just selected on the integral screen. Further button-presses cycle through the available modes of operation.



The loudspeaker operating mode is stored separately for each source. The 'Disc' source also differentiates between Audio CD / Media Audio (from USB) and Video Disc (Bluray).

Stereo

Reproduction only through the two primary loudspeakers (left / right) of loudspeaker group A.

Virtual surround

Virtual Surround reproduction via the loudspeakers of group A. In this mode of operation it is possible to achieve surround effects even without the presence of physical rear loudspeakers.

3-channel MUSIC (can only be selected if a Centre loudspeaker is present)

This setting is for music reproduction through all three loudspeakers of group A (left / right / centre).

3-channel MOVIE (can only be selected if a Centre loudspeaker is present)

Three-channel sound reproduction (left / right / centre), ideal for use with cinema films.



The **K2 Blu** features a digital room sound (sound field) processor, which can be used with two or three loudspeakers in the primary listening room. With three speakers (left / centre / right) it is possible to achieve more natural and spacious reproduction overall, without the familiar "acoustic hole" in the middle. For film playback an additional advantage is an improvement in localisation of speech and sound events on the screen.

If the **K2 Blu** is operated with just two loudspeakers (left / right), then only the operating modes STEREO and Virtual Surround are available.

FM100



K2 Blu



Tone settings

Tone settings (Tone menu)

The **K2 Blu** features a range of facilities designed to enable you to adjust the sound to suit your personal preferences, the physical arrangement of your system components, and the acoustics of your listening room. All these settings are adjusted in the tone control menu (TONE menu). The tone control menu can be called up using either the button on the remote control handset, or via the Tone menu point (tone settings) within the menu.

The **K2 Blu** features automatic loudspeaker detection, which it invokes every time it is switched on to indicate which loudspeakers are connected to it.

Some points in the Tone menu only appear if the associated loudspeakers are actually connected to the system, and are switched on in the System menu. If the relevant loudspeakers are not present in the system, then the set-up points relating to them are not displayed. This restricts the task of operating the system to the facilities actually present, and considerably simplifies the procedure.

If some menu points do not appear, even though the associated loudspeakers are correctly connected, please refer to the notes in the chapter entitled 'Trouble-shooting'.

Menu point	Adjustment range options:	Explanation:
Treble Bass	-12 ... 0 ... +12	These two menu points are used to adjust the treble and bass settings.
Tone Control	off / on	This menu point can be used to disable (bypass) the K2 Blu 's tone controls. To switch off the tone controls, select the "OFF" setting. When the tone controls are switched off, any adjustments you make to the following menu points "BASS" and "TREBLE" have no effect.
Loudness	off / on	The K2 Blu features a volume-dependent tone correction system (LOUDNESS) which compensates for the frequency-dependent variation in the sensitivity of the ear at very low volume levels due to the physiology of the human auditory system. This set-up option is used to switch loudness on or off.
Balance Balance A L/R balance for loudspeaker group A	70L ... 0 ... 70R	This menu point is used for altering the level balance between the left and right loudspeakers, in order to compensate for an imperfect listening position. The level balance can be adjusted in increments of 1 dB; the current value is displayed on-screen.
Balance B L/R balance for loudspeaker group B (The menu point only appears if loudspeaker group B is connected)	70L ... 0 ... 70R	Setting as in the previous menu point, but for loudspeaker group B.

Menu point	Adjustment range options:	Explanation:
<p>Fader Balance between loudspeaker groups A and B (The menu point only appears if loudspeaker group B is connected, and if two-room mode is switched off in the System menu.)</p>	-15 ... 0 ... +15	<p>The Fader function is used to adjust the balance between loudspeaker groups A and B, if these are located in the same room.</p> <p>If two-room mode is selected, this point is not displayed, since in this mode the volume of loudspeaker group B is controlled separately using the external remote control receiver.</p>
<p>Center (This menu point only appears if a Centre loudspeaker is connected to the system)</p>	-15 ... 0 ... +15	<p>Menu point for adjusting Centre volume. We recommend a setting at which the Centre speaker fills the acoustic gap in the middle between the main loudspeakers, but is not quite detectable as a separate sound source.</p>
<p>Subwoofer (This menu point only appears if an external sub-woofer is connected to the system, and is switched on in the System Configuration menu / Loudspeaker menu.)</p>	-15 ... 0 ... +15	<p>This Menu point is used to adjust the volume level of the sub-woofer.</p> <p>Adjust the volume of the sub-woofer to suit the acoustic conditions in the listening room, and the volume of the other channels.</p>
<p>Sound (sound fields)</p>	<p>The following-setup options are intended for adjusting the reproduction of the K2 Blu to suit the room acoustics.</p>	
	<p> This setting is stored separately for each source. The 'Disc' source also differentiates between Audio CD / Media Audio (from USB) and Video Disc.</p>	
	Normal	<p>Linear, musical tone setting with no enhancements; recommended for normally damped listening rooms.</p>
	Dynamic	<p>Linear sound image with good dynamics and precision Particularly recommended for rooms with severe damping, and loudspeakers which tend to emphasise bass.</p>
	Warm	<p>If you prefer a relaxed sound image with slightly subdued treble, select the sound field option Warm.</p>
	Speech	<p>This option improves speech clarity in spoken word programmes, documentaries and sports transmissions.</p>
	Cinema	<p>Setting for use with cinema films, offering good dialogue comprehensibility.</p>

System settings (System Configuration menu)

The System Configuration menu is used for adjusting the general settings of the machine. This menu is described in detail in the following chapter.

Calling up and operating the menu

- The menu is called up by briefly pressing the **(SYS / Ⓞ)** button on the front panel or the remote control handset.
- Once the menu is open, the following select points appear on the screen:

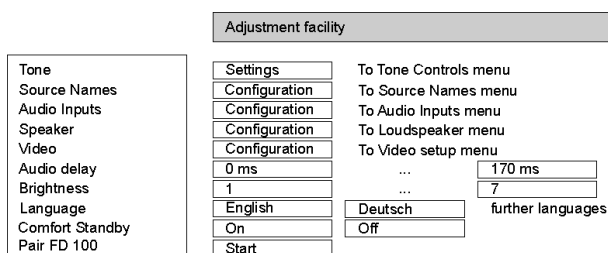

- Use the **(▲)** / **(▼)** buttons to select a menu point.
- If you wish to change a selected menu point, first press the **(OK)** button, then change the value using the **(◀)** / **(▶)** buttons.
- To accept the change, press the **(OK)** button again after altering the setting.
- To quit **without** accepting a changed value, you can interrupt the procedure at any time by pressing the **(■)** button.
- Press the **(SYS / Ⓞ)** button again to leave the menu.

Menu point Tone

Using this menu point you can access the Tone menu by pressing the buttons on the **K2 Blu**.

- (i)** This menu can also be called up directly by pressing the **(🎵)** button on the FM100 remote control handset.

Menu point Source name

At this menu point you can activate and disable external sources, and assign a plain text name to each source; this name then appears in the screen displays. For example, you might wish to assign the display name *"Media Centre PC"* to the DIG IN 2 input.

When you call up this menu point using the **(OK)** button, a list of all the external sources of the **K2 Blu** appears. Each source is followed by the assigned name, or if you have disabled the source concerned the note 'disabled'.

If you want to activate / disable a source, or change the plain text name, navigate to the appropriate line.

To activate a source, press the green **(☺)** button; pressing the red **(☹)** button disables the source.

To change the plain text name, press the **(OK)** button once more. Change the name as you wish, then press **(OK)** to confirm your choice. This action stores the settings for the source. If necessary, the display name can be changed as often as you wish. When the name input process is complete, press the **(OK)** button to store it.

A name can only be entered for external source devices, i.e. those connected to the following inputs of the **K2 Blu**:

TAPE IN, iPod, TV IN, AUX IN, DIG IN1, DIG IN 2 und Bluetooth Audio.

- (i)** When you call up Source Select using **(A1 / AUD)** / **(A2 / VID)** on the remote control handset or the source button **(🎵)** on the front panel, any disabled sources are suppressed. This makes it easier to select sources, and we recommend that you disable any sources not in use.

Menu point
Audio - inputs

This menu point opens a sub-menu in which the settings for the audio inputs can be altered.

Sub-Point
TV

Some TV sets are fitted with digital electrical (co-ax) or optical (TOSLINK) outputs. It is possible to use the **K2 Blu** with such equipment by assigning an optical (DIG IN 1) or electrical (DIG IN 2) digital input to the **K2 Blu's** TV input instead of the analogue sound input (TV IN). In this case the **K2 Blu** accepts and processes the digital stereo signal (PCM signal) from the source device instead of the analogue signal.

Here you can select the input to match your TV set.

i If a digital input (e.g. DIG IN 1) is assigned to the TV source, then that input is no longer available as a separate source.

Sub-point
TV auto power-on

This menu point enables you to switch on the automatic power-on function for the TV input of the **K2 Blu**.

If this function is switched on, the **K2 Blu** automatically switches itself on from stand-by mode, and switches to the TV source (if necessary), when a music signal is present at the TV IN, DIG IN 1 or DIG IN 2 input - depending on the input to which the TV source is assigned (see above).

If the **K2 Blu** is switched on, but no signal is detected at the TV input within about twenty minutes, then the **K2 Blu** automatically switches itself off again; however this only occurs if the TV source is selected.

In this mode of operation the volume control for the TV source is separate, i.e. the volume level for this source is stored separately, and only changes when the TV source is selected.

This makes it possible to pre-set a fixed volume at the **K2 Blu**, and to control the volume using the TV set connected to the system.

Of course, the volume can also be controlled using the **K2 Blu**, and the TV set left at a fixed level.

i The automatic TV power-on function is only supported if 'Energy saver' is switched off in the System menu.

Menu point
Speaker
(Loudspeaker menu)

This menu point opens a sub-menu in which the settings for the loudspeakers can be altered.

Adjustment facility					
L / R	Full range	Bass extd.	40 Hz	...	150 Hz
Center	Full range	Bass extd.	40 Hz	...	150 Hz
Subwoofer	Off	40 Hz	60 Hz	100 Hz	150 Hz
SPK A stand	Free	Near to wall	In a corner		
SPK B stand	Free	Near to wall	In a corner		
2nd-Room	On	Off			

Sub-point
L/R

In this menu point you can set the loudspeaker type and, if appropriate, the cross-over frequency between the main loudspeakers (loudspeaker group A - left / right) and the sub-woofer.

If you are using full-range loudspeakers, please choose the "FULL RANGE" setting. For relatively small satellite speakers we suggest that you choose a cross-over frequency of 40Hz, 60Hz, 100Hz or 150Hz, depending on the size and bass performance of your loudspeakers.

This is the basic rule: the smaller the speaker cabinet, the higher the cross-over frequency should be. If no sub-woofer is present in the system, you should always select the "FULL RANGE" setting in any case.

The "Bass extd." setting is recommended for small loudspeakers such as small bookshelf units, if they are operated without a sub-woofer. At this setting the bass range of the speaker is extended to low frequencies.

Sub-point
Center
 (This menu point only appears if a Centre loudspeaker is connected to the system)

Setting of loudspeaker type and cross-over frequency between the Centre loudspeaker and the sub-woofer.

The procedure is as described under the menu point 'L/R'.

i If this menu point does not appear, even though a Centre loudspeaker is connected to your system, please read the notes in the chapter entitled 'Trouble-shooting'.

Sub-point
Subwoofer

In this menu point you can set the cross-over frequency for your sub-woofer. If your system does not include a sub-woofer, you should choose the "OFF" setting.

If a sub-woofer is present and you are using satellite loudspeakers, the same cross-over frequency should be set here as in the previous menu point.

If you are using full-range loudspeakers which are supplied by a supplementary sub-woofer in the deep bass range, we recommend the 40 Hz setting.

Sub-point
SPK A stand

Please select one of the LS A set-up options free / near to wall / in a corner,

according to the location of your primary loudspeakers.

If loudspeakers are set up close to a wall or a corner, the result may be a disproportionate boost to the low frequencies. To compensate for this effect the **K2 Blu** features a corrective circuit which you can set in this menu point for the main loudspeakers.

Sub-point
SPK B stand
 (This menu point only appears if loudspeakers are connected to loudspeaker output B)

Settings as in the preceding menu point, but applicable to loudspeaker group B

Sub-point
2nd-room
 (This menu point only appears if loudspeakers are connected to loudspeaker output B)

At this point you can determine whether loudspeaker group B is to form its own listening zone with separate volume control.

If you choose the OFF setting, the volume of the 'B' loudspeakers is controlled in tandem with the loudspeakers of group A (e.g. for two listening zones in one room).

If you select the ON setting, the volume of the 'B' loudspeakers can be controlled separately. This is only possible if you connect the E2000 external remote control receiver (supplied in the accessory pack) to the machine, and set it up in the second room.

The FD 100 can be used to switch between control of the two zones using the **F3** button (see chapter entitled 'F 100 radio remote control').

i For more information relating to modes of loudspeaker operation please refer to the chapter entitled 'Listening zones and bi-amping'.

Menu point
Video
 (this menu point only appears in conjunction with **T+A** TV Connect)

Adjustment facility

Disc	HDMI-1 ..2 ..3	YUV	RGB	...	further settings
TV IN	HDMI-1 ..2 ..3	YUV	RGB	...	further settings
iPod	HDMI-1 ..2 ..3	YUV	RGB	...	further settings
TAPE IN	HDMI-1 ..2 ..3	YUV	RGB	...	further settings
AUX IN	HDMI-1 ..2 ..3	YUV	RGB	...	further settings
DIG IN 1 (opt.)	HDMI-1 ..2 ..3	YUV	RGB	...	further settings
DIG IN 2 (coax.)	HDMI-1 ..2 ..3	YUV	RGB	...	further settings
Bluetooth	HDMI-1 ..2 ..3	YUV	RGB	...	further settings

This menu point opens a sub-menu where you can assign the audio inputs of the **K2 Blu** to the video inputs of a video monitor. The **K2 Blu** then switches the monitor on automatically when you select an AV source whose operation requires it. When you switch sources, the monitor's correct picture input is selected automatically.

If your system includes a **Loewe-** or **Metz** video monitor, use this sub-menu to select the appropriate picture input of the monitor for each AV source which is connected to the monitor (picture) and the **K2 Blu** (sound).

i This menu is only relevant if the **K2 Blu** forms part of a system which includes a compatible **Loewe** or **Metz** monitor (television). This sub-menu is irrelevant if no video monitor is connected to the **K2 Blu**. In this case the menu is not displayed!

If your system includes a Loewe or Metz monitor, you will also need the TV control lead with RS 232 connectors (TV Connect), available as an accessory from **T+A**. (see '**T+A** TV Connect')

Menu point Sound delay	<p>Every video monitor requires a certain amount of time to display the video signals (latency); this period may vary from monitor to monitor. If your monitor has a long latency, the result may be a perceptible time-lag between the picture and the sound. This is usually apparent when lip movements are not properly synchronised with the soundtrack.</p> <p>To compensate for this effect the K2 Blu features a digital sound delay module (Lipsync) which can be used to synchronise picture and sound reproduction.</p> <p>If necessary, set a delay time in this menu point which corresponds to your video monitor. If the latency of your monitor is not stated in its Specification, you will need to determine the appropriate value experimentally, e.g. by playing a DVD in the original speech version (non-synchronised version). During playback simply adjust the value for sound delay until the speaker's lip movements coincide with the sound.</p>
Menu point Brightness (Screen Brightness)	<p>At this point you can adjust the brightness of the K2 Blu's integral screen to suit your personal preference in normal use. Seven levels are available.</p>
Menu point Language	<p>In this menu point it is possible to determine the language which is to be used for the displays on the integral screen on the front panel of the K2 Blu.</p> <p>i The language used for any transferred data, e.g. from an iPod or an Internet radio station, is determined by the device itself or the radio station, and therefore cannot be selected on the K2 Blu.</p>
Menu point Energy saver (Stand-by mode)	<p>At this menu point you can switch the energy-saver function on and off.</p> <p>With the energy-saver function turned on, the machine automatically switches to stand-by mode after ninety minutes without a music signal or operating command. Non-essential functions are also disabled in order to minimise current drain in stand-by mode (ECO Standby).</p> <p>If the energy-saver function is turned off, the current drain is slightly higher, but additional functions are available (Comfort Standby). At this setting the automatic power-off function is disabled.</p> <p>The following functions are available in each case:</p> <p>On (ECO Standby): Active functions in ECO Standby mode: automatic power-off after ninety minutes without music or operating command. Power-on via remote control (not F 100 radio remote control), alarm timer without time display.</p> <p>Off (Comfort Standby): The following additional functions are available: time of day, power-on via F 100 radio remote control, automatic power-off function disabled.</p> <p>i For information on energy-saving operation, and accurate information on current drain in the various operating modes, please refer to the Chapter entitled 'Notes on Energy Saving' and the Specification in the Appendix</p>
Menu point Pair FD 100	<p>When you call up this menu point, the K2 Blu attempts to create a connection with the K2 Blu radio remote control (see chapter 'FD 100 radio remote control').</p> <p>i The FD 100, a graphic radio remote control handset with integral colour screen, is designed to make the K2 Blu even more convenient to operate, and is available as part of the T+A accessory range. The K2 Blu is prepared for use with the FD 100. (see chapter 'FD 100 radio remote control')</p>

Alarm Timer

The machine is fitted with an integral Timer module which can switch the **K2 Blu** on with a user-selectable source at a programmable time (alarm clock).

Selecting an alarm timer in the alarm timer menu switches on and activates the timer. The active alarm timer is indicated on the screen by the Timer LED, which glows constantly.

You can now switch the **K2 Blu** off. As long as the Timer LED is lit, the **K2 Blu** will switch itself on at the pre-set time.

Alarm

- with automatic power-off

When the Timer is active, the **K2 Blu** switches on at the programmed alarm time.

When switched on, the Timer LED flashes.

One hour after the alarm time the **K2 Blu** switches itself off again automatically, unless you disabled the alarm function during that period.

If you disable the alarm function with a long press on the **(sys / ⏻)** button, the Timer LED ceases flashing. Now the Timer does **not** switch off **automatically** after an hour. If you wish to switch the machine off, you must do so manually.

Switching the Timer off

The alarm timer menu can be called up with a brief press on the **(sys / ⏻)** button; you can disable the alarm timer in that menu.

i The alarm timer menu can also be called up with a brief press on the **(sys / ⏻)** button when the machine is switched off; you can then carry out changes without having to switch on beforehand.

Alarm timer menu







Calling up and operating the menu

- The menu is called up with a long press on the **(sys / ⏻)** button on the front panel.
- When you open the menu, you will hear the currently selected alarm source at the volume which you have set for the alarm function.

The screen displays the following select points:

Adjustment facility			
Alarm	Alarm Time 1	Alarm Time 2	Alarm Off
Alarm Time	00.00		
Alarm Source	Radio BFBS R1	Disc	Tone
Alarm Vol.	0		
Alarm Spk.	A	B	A+B
Time Mode	RDS	Summer time	Winter time
Set Time	00.00		
Brightn.Clk	Off	1	...
			4

- Use the **(▲)** / **(▼)** buttons to select a point in the menu.
- If you wish to alter a selected menu point, first press the **(OK)** button, then use the **(◀)** / **(▶)** buttons to change it.
- To adopt the new setting, press the **(OK)** button again after entering the change.
- To quit **without** accepting a change, you can interrupt the procedure at any time by pressing the **(■)** button.
- To leave the menu, press the **(sys / ⏻)** button on the front panel once more.

Menu point Select alarm time	In this menu point you can select whether the machine is to be switched on with an alarm, and - if so - with which alarm.
Menu point Set alarm time	Manual setting of the alarm time for the currently active alarm. Initially the change occurs slowly, but the rate of change increases if you hold the button pressed in.
Menu point Alarm source	Here you select the source which is to be switched on at the alarm time. If you select the menu point Radio, you can select the radio station of your choice from the Favourites list using the  /  buttons.
Menu point Alarm volume	At this point the alarm volume can be adjusted. If you change the volume, the system immediately adopts the indicated volume value, and the alteration in volume becomes audible.
Menu point Alarm_Lsp. (This menu point only appears if loudspeakers are connected to loudspeaker output B)	Here you select the loudspeaker group to be used for the alarm. The available options are loudspeaker groups A , B and A+B .
Menu point Clock mode	In this menu point you can determine how the internal clocks is to be set. RDS: If you select the menu point RDS, you can select a radio station from the Favourites list using the  /  buttons. If you choose the ' Any ' setting, the time of day will be read automatically from the RDS signal provided by the currently set station, and will be adopted by the machine; this occurs at night and about three minutes after switching on. If a station is selected, the time of day is automatically read out from the RDS signal at night. If the selected station is the current listening source, then the time of day is also taken from the machine when it is switched on. This only works if a good RDS signal can be received. It is not possible to adjust the time of day manually! Summer time: The time of day can be set manually in the menu point 'Set time of day'. Winter time: The time of day can be set manually in the menu point 'Set time of day'.
Menu point Set time of day	Manual adjustment of the internal clock to the correct time. Initially the adjustment occurs slowly, but if you hold the button pressed in, the rate of change increases.  Manual adjustment is only possible if you have already selected Summer or Winter in the menu point 'Clock Mode'.
Menu point Brightness Clock	Here you can adjust the brightness of the integral screen in stand-by mode to suit your personal preference; the revised brightness setting takes effect immediately. The 'off' setting can only be selected if no alarm time is active.  In ECO stand-by mode it is possible to adjust the screen brightness, but the screen is switched off again when you leave the menu. (see chapter ' System settings (System configuration menu) ')

Operating the source devices in detail

Operating the Radio

RADIO

Device display in Radio mode

First select the radio as source by pressing the **RADIO** button.

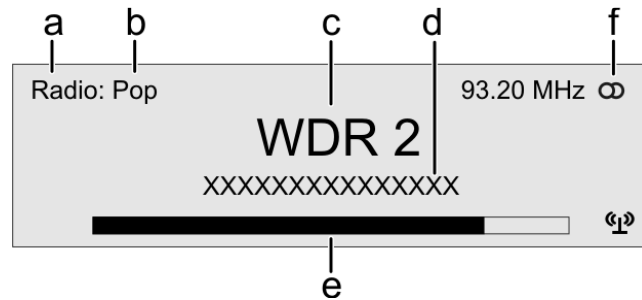

- When you are listening to a radio station in radio mode, the message **'Radio'** appears in the top line of the screen.
- Here the music type or style is displayed, e.g. Pop Music. This information is only displayed if the transmitting station broadcasts it as part of the *RDS* system. If you are listening to a station which does not support the *RDS* system, or only supports it in part, these information fields remain empty.
- The frequency and / or the station name is displayed in enlarged form. If a station name is displayed, its frequency is shown in area 'f'.
- These lines display information which is broadcast by the station (e.g. Radiotext).
- The *field strength* and therefore the reception quality to be expected from the set transmitting station can be assessed from the field strength.
- Display of Stereo / Mono

RDS functions

If the station being received is broadcasting relevant *RDS* data, the following information will be displayed on the screen:

- Station name
- Radiotext
- Program type (genre)

Manual adjustments

Station Search

Holding one of the / buttons pressed in initiates a station search in the upward or downward direction. The station search stops automatically at the next station.

Mono / Stereo

You can toggle the radio of the **K2 Blu** between stereo and mono reception by briefly pressing the button. The reception mode is shown on the screen by the following symbols:

(Mono) or (Stereo):

If the station you wish to listen to is very weak or very distant, and can only be picked up with severe background noise, you should always switch to MONO mode as this reduces the unwanted hiss significantly.



When you store the station in the Favourites list, the settings you enter for this station are also stored, and are automatically restored the next time you call up the station.

Favourites List and Presets

In addition to manual tuning and searching, the radio of the **K2 Blu** also features a **Favourites list** and **Presets**, which provide a fast, convenient method of managing your preferred stations and calling them up at any time.





You can edit the Favourites list to suit your preferences (see section **'Adding stations to the Favourites list / Erasing stations from the Favourites list'**).

It is also possible to store the stations under a station number (Preset), and then to call it up directly by entering the station number. Presets are particularly useful if you wish to call up stations when the screen is not in sight (e.g. from an adjacent room), or via the domestic control system.

Favourites List

Creating the Favourites list



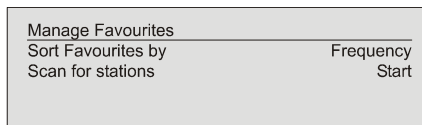

The Favourites list allows the user to store preferred radio stations, i.e. those frequently selected.

When you have called up the Favourites list by pressing the  button (FM100), you can press the  button to call up the Favourites menu, from which the following points can be selected using the  /  buttons:



Select the menu point '**Scan for stations**' and initiate the station search with the  button. The screen displays the message '**Auto Store active**', and the **K2 Blu** now automatically stores up to sixty receivable stations in the Favourites list.

Adding stations to the Favourites list

First set the desired station manually (by briefly pressing the  /  buttons) or using a search (holding the  /  buttons pressed in). As soon as the station is audible, you can add it to your Favourites list by pressing the  button.

Erasing stations from the Favourites list

Open the Favourites list. Select the station you wish to erase from the list, hold the red  button pressed in for a few seconds: the station is now removed from the Favourites list. After the erasure the tuner automatically switches to the next station in the Favourites list.



Sort function

The Favourites list can be sorted according to various criteria; these are selected in the menu point '**Sort Favourites by**': ( button):

Frequency Stations are sorted by frequency in ascending order (RDS stations only)

Station name Stations are sorted alphabetically by station name







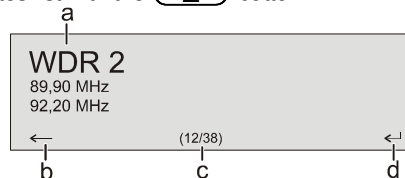

Program ID Stations are sorted by station group (RDS stations only)

Now use the  /  buttons to select the desired sort criterion, and confirm your choice by pressing the  button.

Selecting radio stations from the Favourites list





- Call up the Favourites list with the  button.





- Use the  /  buttons to select a stored station from the Favourites list. The selected station is displayed in enlarged form.
 - Press the  button to return to the station previously selected.
 - Position display in the Favourites list.
 - Press the  /  /  /  button to select the station displayed in enlarged form.
- You can also select stations directly, without calling up the Favourites list as described above, by briefly pressing the  /  buttons in the Favourites list.

Presets

Storing a Preset

- Select a station, either using the  /  buttons, or from the Favourites list.
- Call up the Store Preset function by pressing the  button.
- An input window now appears in which you can enter a number using the numeric buttons ( to ). The Preset is stored when you press a numeric button. The front panel screen briefly displays the message '**Preset Stored at**' to confirm this.

Calling up a Preset

At any time you can quickly call up a station stored as a Preset by entering its Preset number using the **FM100's** numeric buttons  to .

Operating the disc player (Media Player)

Basic functions

Switching on

Press the **ON** button on the player's front panel to switch the machine on. Select HDMI input of your TV set or projector to which the HDMI output of the **K2 Blu** is connected.



Message:

Your BD player appears not to have a correctly configured Internet connection.

Red button to configure the network connection.

If this message appears, the network is not connected, or is not correctly coded. If you do not wish to use BD-Live functions or other Internet functions, you can ignore this message.

If you would like to configure your Internet connection, - call up the Setup menu and enter the settings in the Network category.

Inserting a disc

Open the disc drawer of the **K2 Blu** by pressing the **OPEN** button on the player's front panel, and lay the disc in the depression in the drawer; the side to be played must face down.

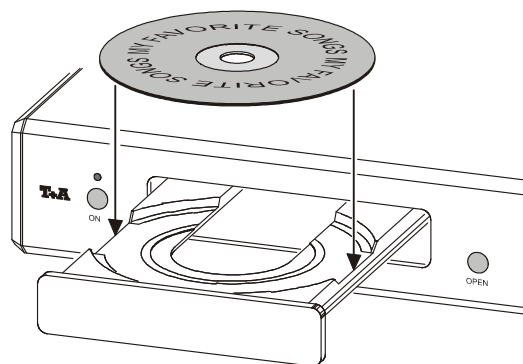

Close the disc drawer by pressing the **OPEN** button again.

Starting playback

Some Blu-ray discs and DVDs feature an "Autostart" function; these discs automatically start playing the main film when the disc is placed in the drawer. When other discs are inserted, a Main Menu is displayed which is then used to start playback manually, or to select a scene.

If a CD does not start automatically, it can be started manually by pressing the **PLAY** button on the front panel, or the **OK** button on the remote control handset.

Stopping playback

Playback can be stopped at any time by pressing the **STOP** button on the machine's front panel, or on the remote control handset.

Pause, resume playback



A brief press on the **PAUSE** button on the front panel (remote control **PAUSE** button) halts playback (pause function). A further brief press on the **PAUSE** button (remote control **PAUSE** button) resumes playback.







Playback is automatically interrupted if you switch to a different source. Playback resumes if you select the 'Disc' source again.

Selecting a Chapter or Title

1.) Selecting with the skip buttons

When a disc is playing, it is possible to skip to the next or previous Chapter with a long press on the  /  buttons on the front panel / remote control handset.

 If you wish to skip several Chapters, you can hold the button pressed in continuously until you reach the desired point, instead of giving repeated long presses on the Skip button.

 The FM100 remote control features additional skip controls in the form of the  /  buttons, which skip forward / back by one Chapter when pressed briefly.

 When the last Chapter of a Title is reached, the **K2 Blu** automatically skips to the first Chapter of the next Title.



2.) Selecting with the Disc menu

Most Blu-ray / DVD discs feature a Disc menu which provides a convenient method of selecting scenes.

During playback the Disc menu can be called up at any time by pressing the  button on the front panel / remote control handset.





Use the Navigation buttons to select the desired scene from the menu, then start playback of the scene by pressing the  button.

3.) Using the numeric buttons to select a Chapter / Title

It is also possible to skip directly to a Chapter on a DVD or Blu-ray disc or a Track on a CD by entering the Chapter number or Track number using the numeric buttons ( ... ) on the remote control handset.

 If the Chapter or Track number has more than one digit, press the numeric buttons briskly in the correct order.

Search

With playback in progress a search can be started with a long press on the  /  buttons on the front panel, or the  /  buttons on the remote control. The speed of the search can be increased by holding the button pressed in.



Press the  button briefly to halt the search.

 Sound is muted during the search process.

Repeat functions (REPEAT)

The K2 Blu has multiple repeat modes (REPEAT) for the repetition of chapters / titles, or the whole disc

Briefly pressing the  button on the remote control handset displays the currently set repeat function on the connected screen. Further button-presses cycle through the other repeat functions.

REPEAT mode	On-screen display
Track / Chapter / Title / File	 Track / File
Disc	 All
Off	

To access Mix mode (shuffle, ) (CD playback only), you must hold the button pressed in. After this, a brief button-press cycles through the various available Mix modes.

 Please note that not all the operating modes can be selected for all discs. Many Blu-ray discs do not feature any Repeat functions.

Menu functions

General

Many functions of DVD and Blu-ray players are controlled using on-screen menus. The **K2 Blu** uses menus for the configuration process and for the basic device settings (Setup menu). The set-up procedure is described in detail in the chapter entitled 'Setup menu (Settings)'.

DVDs and Blu-ray discs may also have their own menus with Select facilities for individual **Titles** and / or **Chapters**. Depending on the DVD / Blu-ray disc, you may also find games, bonus material or alternative camera angles, synchronous speech, sub-titles etc., which can be set up or called up using the Disc menu.

 The content, appearance and behaviour of the Disc menu are determined and controlled by the disc itself. If functional problems occur involving the Disc menu, please contact the disc manufacturer or retailer.













Calling up the Disc menu

The **Disc menu** can be called up at any time during playback, allowing you to carry out adjustments as required.





To call up the menu press the  button on the front panel / remote control handset briefly. If the DVD / Blu-ray disc contains a Select menu, this will now appear on the TV screen.

Menu operation

In the Select menus the following buttons are used for menu navigation:

Remote control	Front panel	
		Brief press during playback: Opens Disc menu, Blu-ray film continues to play
		Long press during playback: Stops films, opens Disc menu
		up
		down
		left
		right
		Confirm button [ENTER]

Navigation within the menu

Use the numeric buttons or the cursor buttons (, , , ) to select an item within the menu; it will then be highlighted.

Selecting a menu point

Press the  button to activate or implement a selected menu point.



Leaving the menu

To quit the Select menu, briefly press the  button on the front panel / remote control handset.

Special modes of operation





Special functions for Blu-ray and DVD discs



Slow motion

A long press on the  button on the front panel or the pause button  on the remote control during playback switches to slow motion mode. Further long presses on the button reduce the speed step by step (1/4, 1/8 etc.).

To halt slow motion, briefly press the  button on the front panel ( FM100) or give a long press on the  button of the F6.

Single frame display

If you wish to display a scene in single-frame mode, first halt playback using the Pause button  / . With playback paused, a brief push on the arrow buttons  /  on the front panel or the FM100 causes the film to be displayed in single frame mode.

Single frame playback is halted with a brief press on the  button on the front panel ( FM100).

Displaying supplementary information (using FM100 only)

A brief press of the  button on the FM100 handset superimposes a window containing information relating to the status of the current playback operation:

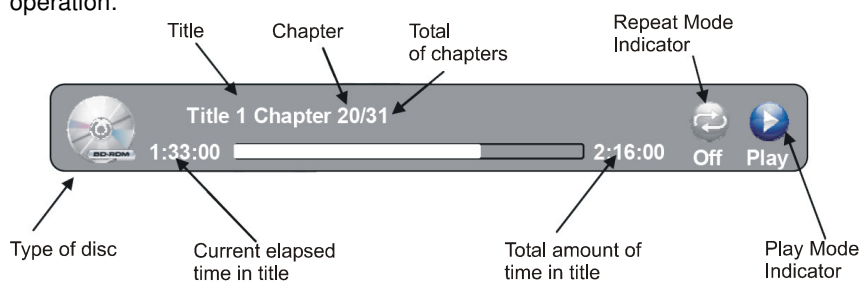



A further a brief press on the  button closes the information window.

Director's commentary
(Blu-ray disc only)

Some Blu-ray discs contain directors' commentaries or other supplementary information. This material can be called up via the "Picture in Picture" (PIP) function of the **K2 Blu**.

To call up the PIP function when a film is running, open Bonus View by briefly pressing the  button. If supplementary information is present on the disc, it will now be displayed in a window superimposed on the film.

Press the  button again to terminate Bonus View.

 Supplementary information is only present on particular Blu-ray media. DVDs do not provide this function.



 Not all Blu-ray discs contain supplementary information.

 Blu-ray discs which do contain supplementary information do not necessarily offer the material for all scenes.

Sub-titles
(using FM100 only)



Many DVD and Blu-ray discs allow you to select the sub-title language during playback as well as via the Disc menu.

This is accomplished by calling up the Sub-title menu by briefly pressing the  button on the FM100 again. Select the desired sub-title language in the menu which now appears.

The menu can be closed by briefly pressing the  button again. Alternatively you can close the menu by pressing the  button.

Switching the soundtrack
(using FM100 only)

Many DVD and Blu-ray discs allow you to change the soundtrack during playback as well as via the Disc menu. This is accomplished by calling up the Sound menu by briefly pressing the  button on the FM100.

The menu can be closed by briefly pressing the  button again. Alternatively you can close the menu by pressing the  button.

Changing the camera angle
(using FM100 only)

A brief press on the  button on the FM100 calls up the Camera Angle menu. If the current scene contains multiple camera angles, these can now be selected from the menu.

The menu can be closed by briefly pressing the  button again.

Alternatively you can close the menu by pressing the  button.

Special functions for CD

Direct track skip
(using FM100 only)

When a CD is playing, the numeric buttons on the remote control can be used to skip directly to any track you like. Simply enter the track number using the numeric keypad.

Playing back digital AUDIO, VIDEO and PHOTO files from CD or USB MEMORY STICK

Introduction

The **K2 Blu** supports playback of digital audio, video and photo files from CD and from USB memory sticks. The media files can be generated, processed and burned to CD using a PC, or stored on a USB stick.



The audio, video and photo formats supported by the **K2 Blu** can be found in the Specification in the Appendix.



We wish to point out expressly that it is impossible to guarantee general compatibility with such files due to the huge number of different encoding and burning programs, disc burners and media which are available.

If you find that such files cannot be played by the **K2 Blu**, we recommend the following measures when creating your CD or USB media:

- Try using a different copy or encoding program
- Try using a different audio, video or photo format
- Try using a different make of blank disc
- Try using a different disc burner

The **K2 Blu** provides the following functions for playing back files:

Video Player

- Pause, Stop, fast forward / rewind, repeat
- Skip to the next / previous video file

Audio Player

- Pause, Stop, fast forward, rewind, repeat
- Skip to the next / previous audio file

Photo Viewer

- Preview pictures (“thumbnails”)
- Slide show

Preparing the K2 Blu for music / video / photo playback

Files which are to be played back using the **K2 Blu** should first be burned onto a CD or saved on a USB stick formatted using FAT32.

Place the disc in the drawer, or insert the USB stick in the USB port on the back of the player.



For safety reasons we recommend that you switch off the **K2 Blu** before inserting and removing a USB stick.

In rare cases you may cause damage to the data on the memory stick if you plug it in or remove it when the machine is operating.

When you place the data CD in the drawer, or plug in the USB stick, the left-hand column of the Main menu displays the type of media files found:

If there are supported media files on the medium, corresponding indicators will appear on the screen

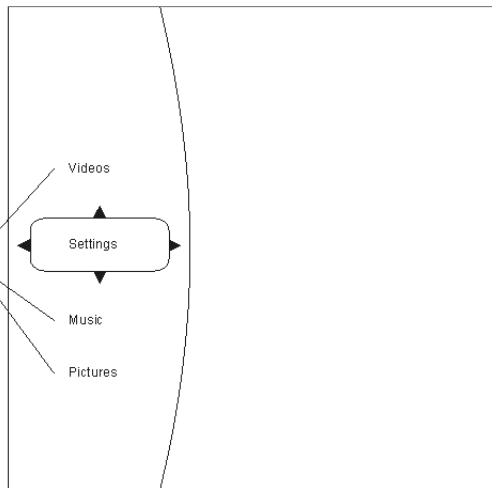

Select from the list which type of file you wish to play.

AUDIO or VIDEO playback

Selecting a source (disc or USB) for playing back audio or video files

Audio and video files can be played back from a disc or a USB memory stick. When you insert the disc or plug the USB memory stick into the USB socket on the front panel, the left-hand category list in the on-screen menu will include the entries 'Videos', 'Audio' etc., according to the content of the memory medium.

Select one of these entries, and press .



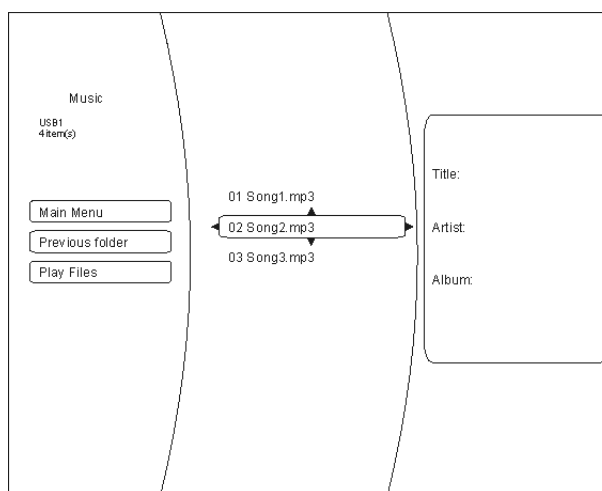

In this way you can find your way to a file which can be played.

i The files which can be played in this mode (e.g. music tracks) are only displayed in the sub-menus if the appropriate playback mode (e.g. Audio) has already been selected.

Example:



Playing back multiple audio or video files

Navigate to the files / folders which you wish to play in the central column of the menu. Use the  button to move to the left-hand column of the menu, and select the 'Play files' menu option play using the  /  buttons. Confirm with the  button, and playback commences.

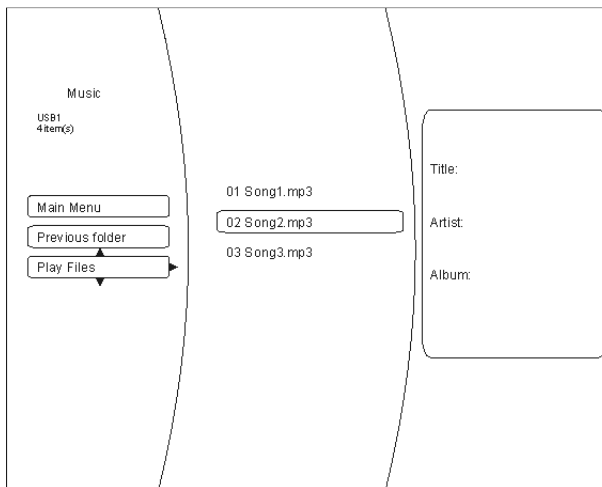

Repeat function (FM100 only)

As soon as the files are playing, you can select any of the following Repeat functions by repeatedly pressing the  button on the remote control handset:

- Repeat File Repeat the current memory piece
- Repeat All Repeat all the selected files
- Repeat Off Repeat function off

Playing back individual files

If you wish to play an individual file, use the arrow buttons to navigate through the folders to the desired file, then press the  button. This action starts playback of the piece.

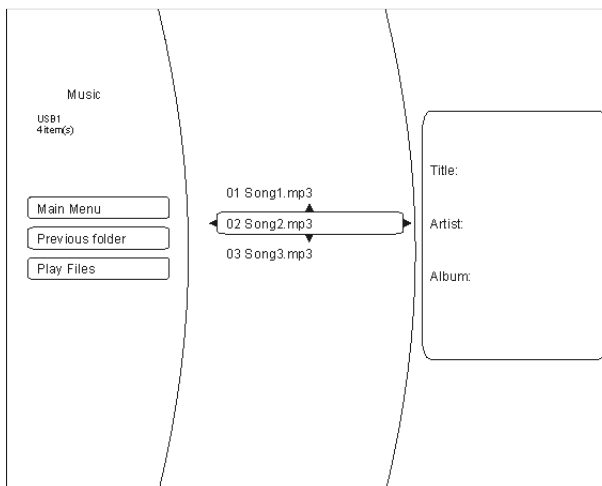

Information display for audio files

When audio files are played back, information relating to the current piece of music is displayed on-screen.

The following information can be displayed - if present in the file being played:

- Filename
- Title
- Artiste
- Album
- Album art (cover artwork)

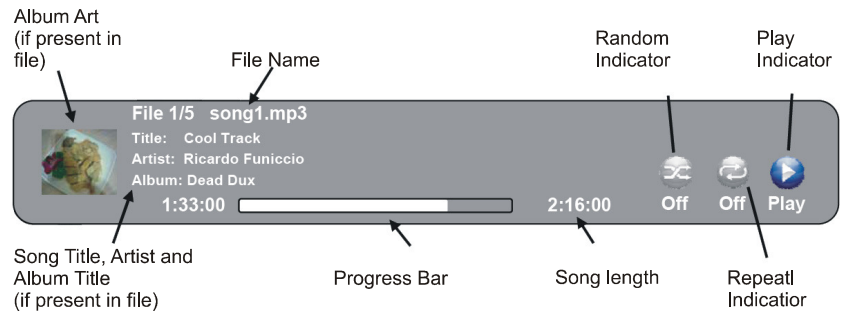

Displaying photo files (slide show)

The **K2 Blu** can display digital photo files which are burned onto a CD or stored on a USB memory stick.

Selecting a picture data source

In principle the procedure for displaying photos is exactly as described in the previous chapter for playing audio and video material.

Select the "Pictures" option in the left-hand column of the Main menu.

Navigate through the folder structure to the folder which contains the desired photos. The photos in the folder are now displayed as preview pictures (known as "thumbnails"):

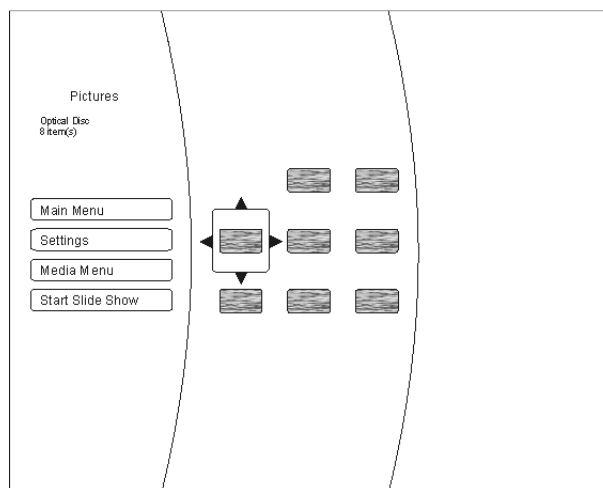

You can now use the menu options on the left-hand side of the screen to select the whole folder as a 'slide show', or select a single picture to be displayed by selecting with the navigation buttons and confirming your choice with the **OK** button.

menu point Settings

Using the 'Settings' menu option (in the 'Pictures' play mode) you can carry out changes to the picture display:

- Slide show effects
 - Horizontal scroll
 - Fade
 - Shutter
- Slide show delay
 - No delay
 - 1 second
 - 2 seconds
 - 5 seconds
 - 10 seconds
 - 15 seconds
 - 30 seconds

Press the **OK** button to close the menu.

Using BD-LIVE™ functions

Introduction

Some (but not all) Blu-ray discs contain supplementary functions. These are known as “BD-Live” functions, and include:

- The facility to load film trailers
- Additional commentaries by actors and directors
- Games
- Chat functions
- Additional bonus material

The following requirements must be fulfilled if you wish to use BD-Live content:

- The **K2 Blu** must be connected to the Internet (LAN connection)
- A USB memory stick with adequate free space must be plugged in

Preparing the K2 Blu for BD-Live use

Connecting BD-Live memory

Using BD-Live requires a USB memory stick with a free capacity of at least 1 GByte.

1. The USB stick must be formatted using the FAT32 file system.
2. If this is not the case, please use a PC to format the stick with the FAT32 file system before use.
3. Plug the memory stick into the front panel USB port of the **K2 Blu**.

Preparing the K2 Blu for Internet access

This is the procedure for preparing the **K2 Blu** for Internet access:

1. In the Setup menu (Settings) of the **K2 Blu** select the “System menu”.
2. In the menu select the point “BD-Live Internet Access”.
3. Ensure that “**Limit Access**” or “**Always Allow Access**” is selected.
4. Insert the prepared USB memory stick.
5. If there is less than 100 MByte of free space on the memory stick, select the option “Clear BD Storage”. **This action erases any data present on the memory stick**, and ensures that there is adequate free memory.
6. Call up the ‘Network’ menu in the Main menu of the **K2 Blu**.
7. Enter the correct network settings, i.e. those matching the settings of your home network, your network router and your ISP (Internet Service Provider).
8. Carry out the ‘**Connectivity Test**’.

 Your system must pass the ‘Connectivity Test’, otherwise there is no Internet connection, and the BD-Live Internet functions cannot be used.

BD-LIVE notes

Although downloaded BD-Live content is stored permanently on the USB memory stick, you cannot use the content without the corresponding BD-Live disc in the machine. For this reason, always place the appropriate Blu-ray disc in the player when you wish to use BD-Live.

Some BD-Live content has a limited usage time, i.e. it lapses after a certain period. Once the permitted usage time is over, you can no longer use the material. From time to time it is therefore necessary to free up the USB stick of data which you no longer use, or which can no longer be used. The unwanted data can be erased using the sub-function “Clear BD storage” in the “System” menu.

 The only option is to erase the whole of the USB memory.

BD-LIVE example: The 6th Day: BD-Live

Select the **BD-Live** option from the “**Special Features**” menu

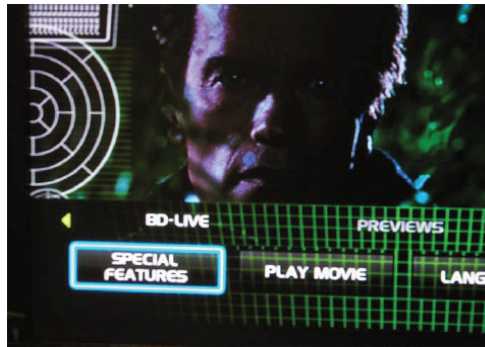

The **BD-Live** menu is now assembled; this may take a few minutes

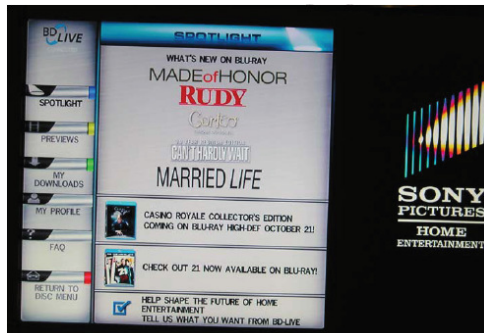

From the **Previews** sub-menu you can now select the content which you wish to download from the Internet.

The downloading process may take a few minutes, depending on the speed of your network.

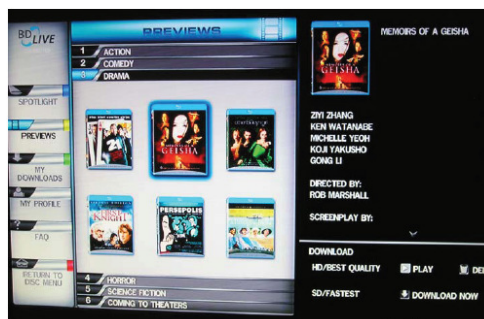

The downloaded content is saved under “**My Downloads**”.
The downloaded content is now ready for use and playback.



Disc menu and Setup menu (Settings)

General notes on menu operation

Introduction

It is important to differentiate between two different menu functions: the Disc menu and the Setup menu.

- The **Disc menu** is located on the DVD / Blu-ray disc itself. In this menu you can control special functions pertaining to the individual disc, such as language, sub-title selection, background information on the film, games, etc.

The content and exact methods of operating this menu vary from disc to disc. Generally speaking it is possible to operate this menu using the navigation buttons listed below, but in any case you should always follow the operating notes which are displayed on the screen.

The Disc menu is opened with a brief press on the  button on the front panel / remote control.

- The **Setup menu** is used for altering settings which apply to the player itself; this menu is described in detail in the following chapters.

The Setup menu appears on the screen when the disc is stopped.

Menu operation

Within the Select menus the following buttons are used for menu navigation:

Remote control



Front panel



Brief press:

Opens the Disc menu (see Chapter '**Special DVD / VCD functions / Menu function**')

up

down

left

right

Confirm button

[ENTER]

Special DVD/Blu-ray / VCD functions

(menu operation and navigation)

Menu function







A DVD / Blu-ray disc may contain a Disc menu with Select facilities for individual **Titles** and / or **Chapters**. Depending on the individual DVD / Blu-ray disc, it may also contain games, bonus material or alternatives for camera angle, synchronised speech, sub-titles etc., all of which can be set up or called up using the Disc menu.



The content, appearance and behaviour of the Disc menu are determined and controlled by the disc itself. If functional problems occur in relation to the Disc menu, please contact the manufacturer or distributor of the disc.

Calling up and operating the Disc menu

The **Disc Menu** can be called up at any time during playback, so that you can make adjustments as required.

- The menu is called up by pressing the  button on the front panel / remote control handset.
If the DVD / Blu-ray disc contains a Select menu, this will now be displayed on the TV screen. The integral screen shows the message 'INFO'.
- Use the numeric buttons or the cursor buttons (, , , ) to select your desired point in the menu, i.e. to highlight your choice.
- To activate or implement a selected menu point, press the  button.
- You can quit the Select menu by briefly pressing the  button on the front panel / remote control once more.

Setup-Menu (Settings)



Blu-ray disc player settings

Opening and operating the Settings menu

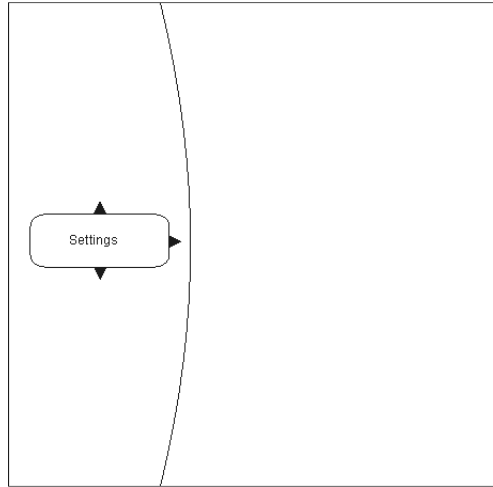
To open the Settings menu, stop playback.





Navigating to the Settings menu point

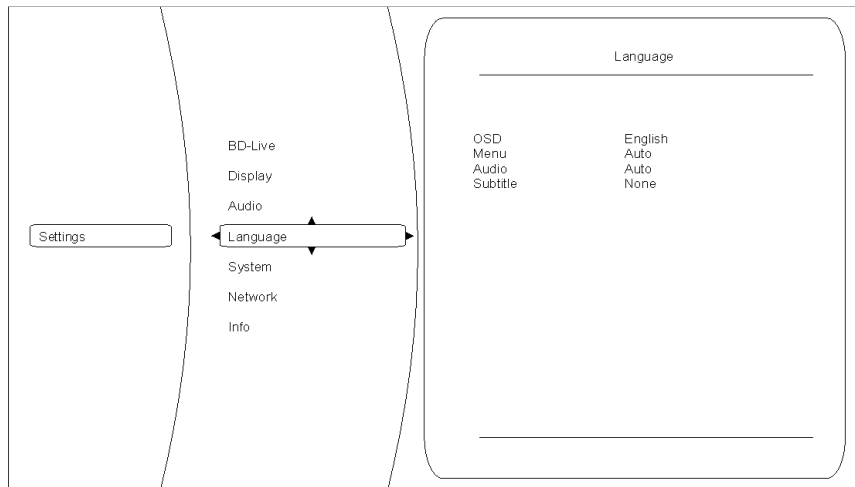

Use the  /  buttons to select the Settings entry in the main menu. You will now see the various sub-categories of the 'Settings' menu. The selected category is highlighted, and the current settings in this category are displayed:



In this example the Language category is selected, with the current settings displayed on the right.

You can select a different category (e.g. Language, System, ...) by pressing  / .

If you wish to change settings within the selected category, please press () again.

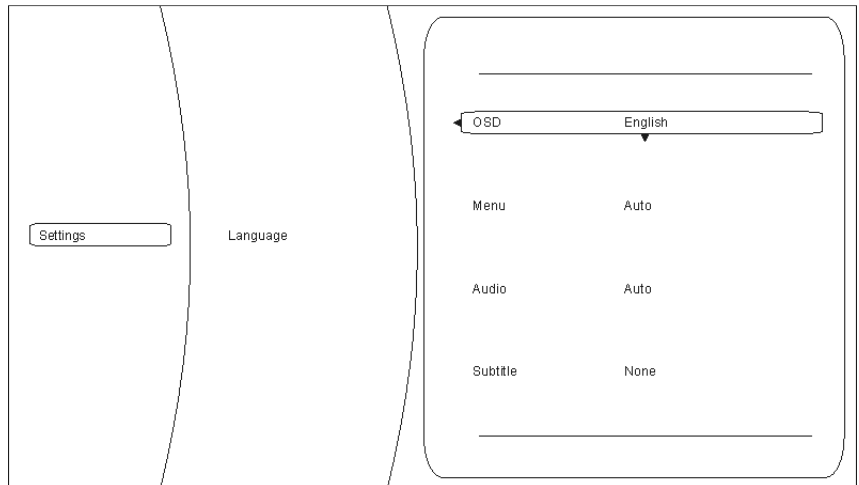

The various options in the selected category are now displayed, and you can select the setting you wish to alter using the () / () buttons.

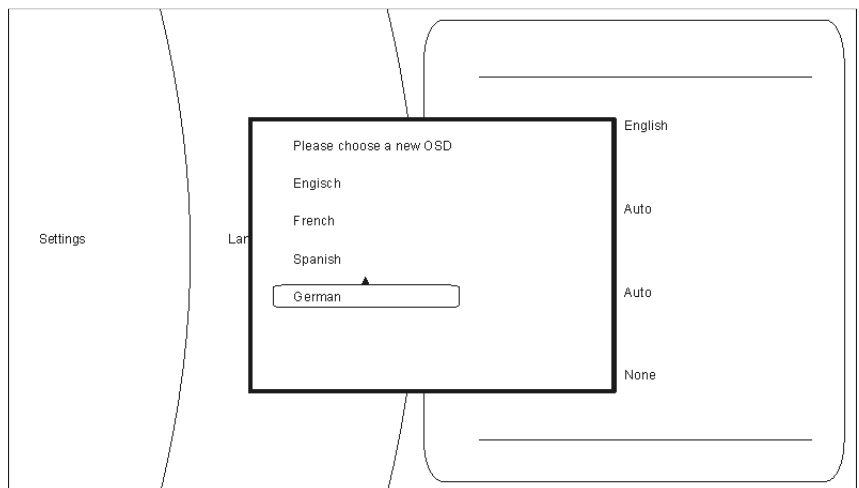

In this example the option 'OSD' is selected, and 'Deutsch' (German) selected as a possible setting.

If you wish to change the set value for the selected option, please press the () button. The available options are displayed in the Settings window.



You can now select a different setting (e.g. English) by pressing the () / () button, followed by () to accept and store the value.

The Setup menu contains the following categories:

- Display
- Language
- System
- Network
- Info
- BD-Live

These categories are described in greater detail in the following sections.

Display category

Overview

Please select the 'Display' category if you wish to set the optimum values for the video output.

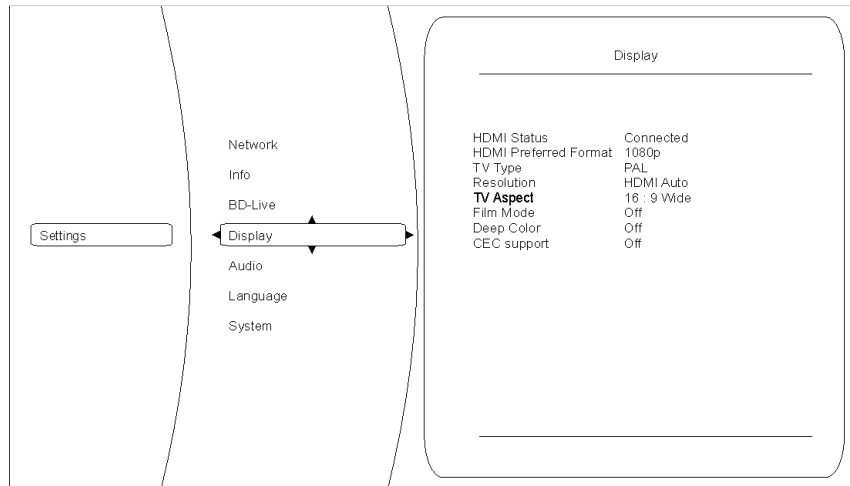

Colour system

Please set the video norm for your display device at this point.

NTSC: Video output at 60 Hz

PAL: Video output at 50 Hz

Incorrect settings may result in a jerky and incorrect display.

Resolution

At this point you should set the maximum resolution of the display device connected to your system. For accurate information on the maximum resolution of your display device please refer to the operating instructions supplied with the unit.

The following resolutions are available:

Resolution	Display devices e
HDMI auto	The K2 Blu automatically selects the optimum setting for the display device connected to the system. This is the recommended setting, which should always be used if possible. You can try out one of the other settings to see if it suits your television, but only if the AUTO setting causes picture problems with your TV.
1080p	Your display device is capable of full HDTV resolution (full HD).
1080i	The display device connected to the system is a high-definition device (HDTV) which can only be used at 1080i resolution.
720p	The display device connected to the system is a high-definition device (HDTV) such as an LCD or Plasma flat screen designated 'HD-ready'.
576p	The display device connected to the system is a standard-definition device which can also process progressive signals (SDTV).
576i	The display device connected to the system is a standard-definition device (SDTV) for NTSC / PAL (e.g. conventional CRT television)



At any setting apart from AUTO you must also set the frame rate under "Colour system" to match the disc in use.

PAL-DVD := PAL (50 Hz),

NTSC-DVD := NTSC (60 Hz)

Blu-ray := PAL or NTSC - according to the disc.

(For Blu-Ray, in most cases it is NTSC / 60 Hz)

If you set the wrong frame rate, picture reproduction may be jerky.

Picture aspect ratio

At this point you can determine the aspect ratio (16:9 / 4:3) of the display device connected to your system.

The possible formats are:

- 16:9 widescreen
- 16:9 pillar-box
- 4:3 letterbox
- 4:3 pan & scan

Please select the appropriate setting from the table below:

	Aspect ratio of the display device			
	16:9		4:3	
	16:9 widescreen	16:9 pillar-box	4:3 letterbox	4:3 pan & scan
Disc content				
Film in widescreen format (16:9)	The picture is unchanged, and is displayed filling the screen	No effect – the picture is unchanged, and is displayed filling the screen	The picture is unchanged, and displayed full-width, leaving horizontal black bars above and below the picture.	The picture is unchanged, and displayed full-height. The right and left-hand edges of the picture are not shown.
Film in 4:3 format	The picture is stretched horizontally, and displayed filling the screen	The picture is unchanged, and is displayed centrally, leaving vertical black stripes on both sides of the picture.	No effect – the picture is unchanged, and is displayed filling the screen.	No effect – the picture is unchanged, and is displayed filling the screen.



If you select the 16:9 setting when the display device connected to the system is a 4:3 type, you may find that no picture is displayed at all.

Film mode

This setting allows you to define whether your display device is capable of processing film material directly at 24 frames per second.

Cinema films are usually recorded at a speed of 24 frames per second, and many movies are also present on Blu-ray discs in this format. However, not all display devices can process this format directly. It is important that you select the correct setting for your display device:

On: Your display device is connected via HDMI, and can process film material directly in the 24 fps (frames per second) format.

Off: Your display device cannot directly process film material in the 24 fps (frames per second) format (e.g. conversion to 25 / 30 fps or 50 / 60 fps is required).

 Selecting an incorrect setting may result in no picture on your display device!

 The setting selected here is only effective:

- if the resolution is set to 1080p / HDMI auto,

and

- if the film material was recorded at 24 fps.

Deep Colour

This setting enables you to decide whether the picture to be transferred via the HDMI output features expanded colour range (Deep Colour). The expanded colour range allows for finer graduations in the colours to be displayed, which in turn permits higher contrast values and better colour blends.

Please select the appropriate setting to suit your display device:

On: your display device is connected via HDMI and is capable of processing Deep Colour.

Off: your display device cannot process Deep Colour.

CEC support

The CEC function enables your TV set's remote control handset to operate the basic functions of the **K2 Blu's** disc mechanism.

 If you wish to make use of this function, please ensure that the TV set connected to the system supports the CEC function.
It is not possible to guarantee that the system works perfectly with all TV sets, since manufacturers' implementations of the CEC function vary.
If you find that the system malfunctions due to incompatibility problems, we recommend that you switch this function off.

Leaving the category

When you have entered all the correct settings in the category, you can leave it by pressing the  button.

Audio category

At this point you can adjust the audio settings of the **K2 Blu disc mechanism**.

Overview

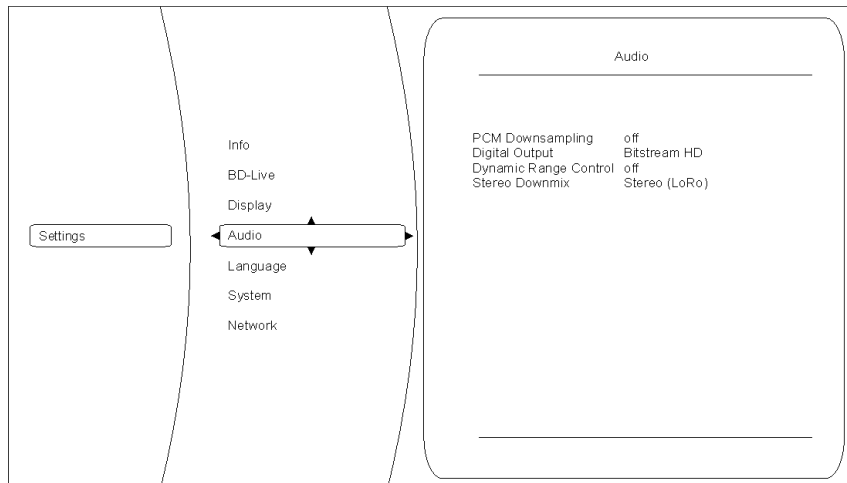

PCM Downsampling

(the settings you select here only affect the HDMI output)

In many cases it may be necessary to limit the sampling frequency (also known as the sampling rate) of the PCM output signal, e.g. if the sampling frequency of a Blu-ray disc is 192 kHz, but the TV set connected to the system can only process 96 kHz. Available settings are: OFF, 96 kHz and 48 kHz

Digital Output

(the settings you select here only affect the HDMI output)

Bitstream HD

For best possible audio quality you should select Bitstream HD. This setting supports the reproduction of all stereo and surround formats. However, this setting does not permit the playback of Secondary Audio soundtracks.

PCM Stereo, PCM 5.1 and PCM 7.1

If you select one of these menu points, the primary and secondary audio channels are mixed, and a signal encoded as PCM. Select the PCM setting to suit your loudspeaker configuration.

Bitstream Mix

If you select this menu point, the primary and secondary audio channels are mixed in the form of a DTS-encoded signal.

Bitstream Legacy

This setting only permits the reproduction of Dolby Digital, Dolby Digital Plus and DTS. The Secondary Audio function is not supported in this configuration.

Dynamic Range Control

Setting for dynamic limiting when playing Dolby Digital encoded discs.

If you prefer sound reproduction with reduced dynamic range, you can select dynamic limiting at this point. The sound is reproduced with full dynamic range at the OFF setting, whereas dynamic range is greatly reduced at the ON setting. If set to AUTO, the machine switches automatically between the two modes of operation in accordance with information on the disc.

Stereo Downmix

For playing back surround-encoded material please select the 'Lt Rt (surround encoded)' setting; for playing stereo material please choose the 'Lo Ro' setting. If you select the 'AUTO' setting, the machine switches between the settings described above in accordance with the material being played.

Language category

At this point you can select the language settings for the **K2 Blu**.

Overview

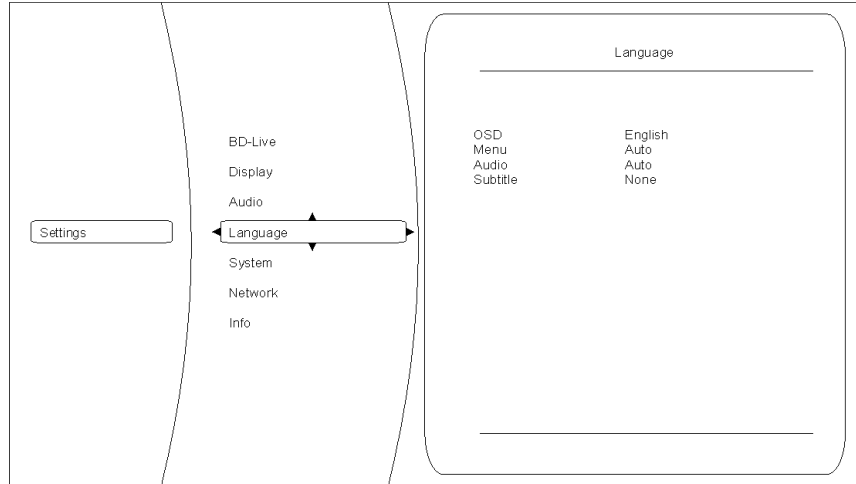

OSD

Here you can change the language used for the on-screen menus. Please set your preferred language.

Menu

This setting defines the language in which the Blu-ray or DVD main menu is displayed. If you select the 'AUTO' setting, the default language for the particular Blu-ray / DVD disc is used.

i Please note that not all languages are present on every disc.

Audio

Setting for the film soundtrack. If you select the 'AUTO' setting, the default language for the particular Blu-ray / DVD disc is used.

i Please note that not all languages are present on every disc.

i Some discs do not allow the language to be selected using the Setup menu of the **K2 Blu**. In this case the language can only be changed using the main menu present on the disc itself.

Sub-titles

Setting for the language used for sub-titles. If you set 'OFF', no sub-titles are shown.

i Please note that not all languages are present on every disc.

i Some discs do not allow the language to be selected using the Setup menu of the **K2 Blu**. In this case the language can only be changed using the main menu present on the disc itself.

Leaving the category

When you have entered all the correct settings in the category, you can leave it by pressing the  button.

System category



This category contains various system settings of the **K2 Blu** such as options for network access, USB, Play mode, ...:

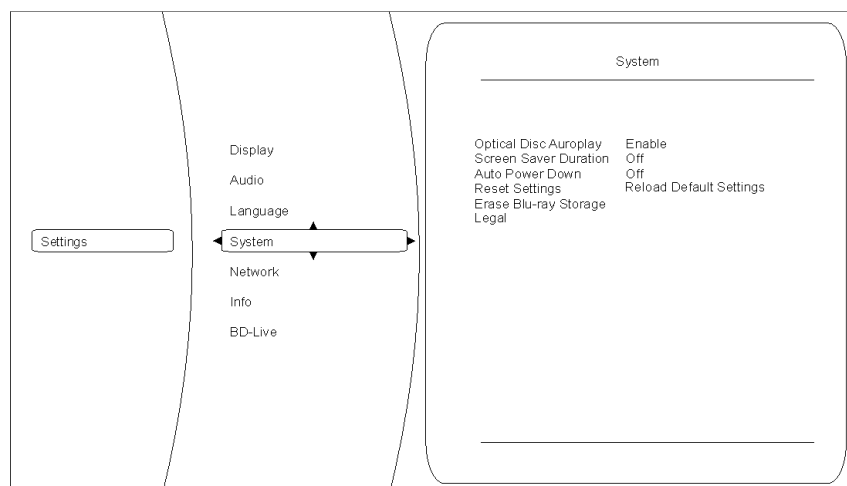

Overview



Optical discs

At this point you can determine whether playback starts automatically when a medium is inserted, i.e. without the need to press the Play button.

Activate: when you insert a disc, playback starts automatically without the need to press  / .

Disable: when you insert a disc, playback only starts after you press  / .



The 'Activate' setting does not mean that the film starts immediately; the copyright warning and any previews present on the disc are not skipped!

Screen-saver

The **K2 Blu** features a screen-saver designed to prevent static images causing damage ("screen-burn") to the display device connected to the system. The screen-saver is activated after a user-selectable time when playing music, or if the main menu of a DVD / Blu-ray disc is displayed constantly; it simply switches the screen dark.

Please use this option to define the time after which the screen-saver is triggered.

Possible settings are:

- 5 minutes
- 10 minutes
- 20 minutes
- 30 minutes
- off

Automatic power-down

Please use this option to define the time after which the **K2 Blu** disc mechanism switches itself off.

Possible settings are:

- 30 minutes
- 45 minutes
- 60 minutes
- off

Erase Blu-ray storage

This option is used to erase the external storage medium.

Reset settings

If you activate this function, the player is reset to the factory default settings, i.e. all the settings you have entered are lost.

After performing a reset, please press button  on the remote control to exit menu item.

Leaving the category

When you have entered all the correct settings in this category, you can leave it by pressing the  button.

BD-Live category

Overview

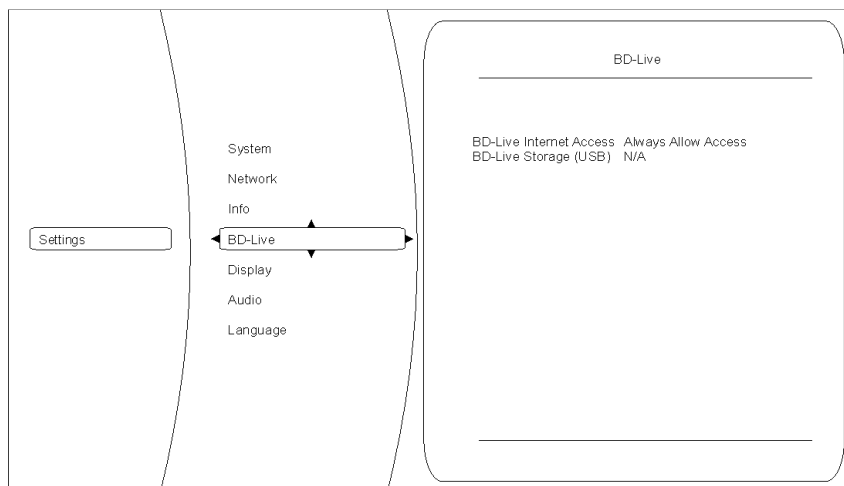

BD-Live Internet access

The **K2 Blu** is capable of accessing content (trailers, previews, supplementary information ...) from the Internet. At this menu point you can define the conditions under which the player is allowed access.

Possible settings are:

Always allow access:

This setting allows the Blu-ray disc in the **K2 Blu** to access all requested content.

Limit access:

This setting allows the Blu-ray disc in the **K2 Blu** to access only those Internet sites which have a valid on-line certificate.

Prohibit access:

This setting forbids the Blu-ray disc in the **K2 Blu** to access any Internet sites

BD-Live storage (USB)

(Erase BD-Live storage)

The **K2 Blu** can store Internet content requested by the Blu-ray disc; to use this facility an external storage medium is required in the form of a USB memory stick.

These two options are used to manage and erase the external storage medium.

Leaving the category

When you have entered all the correct settings in this category, you can leave it by pressing the  button.

Network category (wired network connection)

To be able to display BD-Live content, the **K2 Blu** must have Internet access. Please connect the UPLINK socket on the back of the machine to your network.

Overview

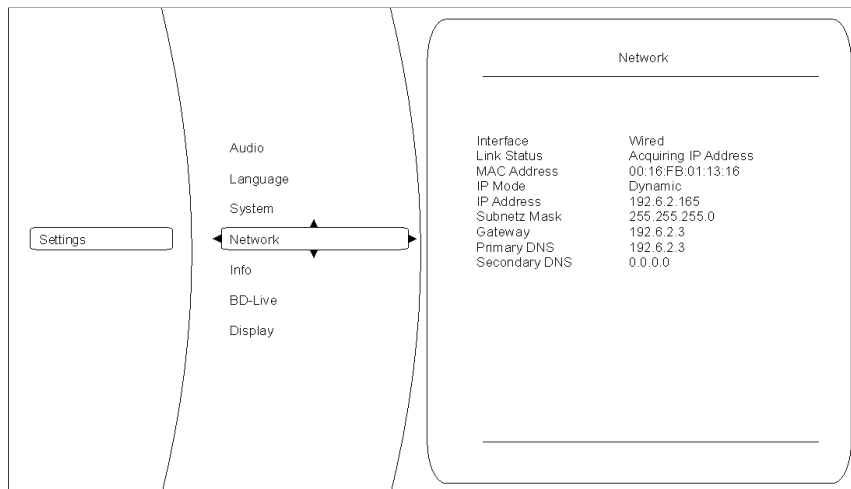

Interface, connection status and MAC address

The first three entries in the network menu are Status messages, i.e. they are for information purposes only, and cannot be altered. Their function is as follows:

Interface:

(in this case always Cable) indicates that the **K2 Blu** is connected to the Internet by a wired connection.

Connection status:

indicates whether the **K2 Blu** can currently access the Internet (Link up). If 'Link down' is displayed at this point, please check the connection to your network, and / or your network settings.

MAC address:

this is a method of identifying your machine, and is required for Internet communication.

IP mode, IP address, Sub-net mask, Gateway, Primary DNS, Secondary DNS

At this point please state whether the **K2 Blu** is to obtain the data required for Internet communication (IP address, sub-net mask, Gateway, DNS) automatically, or whether you wish to configure these data manually.

Dynamic:

the **K2 Blu** obtains its IP address, sub-net mask, Gateway and DNS address automatically. For this setting a DHCP-capable device must be present in your network.

Manual:

in this case you have to enter the IP address, sub-net mask, Gateway and DNS address manually. Selecting this setting activates the appropriate fields.

Network test

When you have completed the network configuration, you can check the network settings here.



Please contact your network administrator if network access is not set up correctly.

Info category

In this menu you will find information about the current version of your machine.

Operating the Streaming Client

General Information on the Streaming Client

The **T+A K2 Blu** includes what is known as a 'Streaming Client'. This is a new class of playback devices for media content, providing a means of playing music which is stored on a vast variety of sources. These sources may be an iPod or a USB hard disc connected directly to the **K2 Blu**, but they may also be thousands of miles away (e.g. Internet radio station). The Streaming Client can access such remote sources via a home network and the Internet.

i The network configuration is explained in the Chapter '**Network Configuration**'.

The **K2 Blu**'s Streaming Client can access the following sources:

Local sources (direct connection)	Remote sources (via home network or Internet)
USB memory sticks and USB hard discs	Internet radio
iPod	NAS server (with UPnP-AV server) PC (with UPnP-AV server)

The media content formats which the **K2 Blu** can reproduce are very wide-ranging, and extend from compressed formats such as MP3, WMA, AAC and OGG Vorbis to high-quality non-compressed data formats such as FLAC and WAV, which are thoroughly audiophile in nature. A full listing of all possible data and playlist formats is included in the Specification, which you will find in the Appendix to these instructions.

Since virtually no read or data errors occur when electronic memory media are accessed, the potential reproduction quality is even higher than that of CD. The quality level may even exceed that of SACD and DVD-Audio.

The **K2 Blu** can also play back high-resolution audio formats (FLAC and WAV up to 192kHz / 32bit). High-resolution audio files can be played back from a USB hard disc connected to the unit, or via a network connection. However, if you wish to use a network for 192/32 reproduction, a cable network must be used since a WLAN network is not generally sufficient for the high data rates (see also the note in the chapter entitled '**Network configuration**').

The music from the iPod is read out digitally, and converted into the analogue music signal by the high-quality internal **T+A** D/A converters. This technique produces the best possible quality of reproduction from an iPod.

i Digital audio output is supported by the following iPod models:

iPod nano (all models) **iPod classic** (all models)
iPod touch (all models) **iPhone** (all models)
iPod 5G

Earlier models of iPod only generate analogue audio output, and are not supported.

Select Lists



The music content to be played is chosen from Select Lists. These lists are operated using the navigation buttons (cursor buttons) which you will find on the remote control handset and on the front panel. All content can be accessed via the main menu. Internet Radio in particular offers a huge number of stations, which can result in long searches or periods of navigation. We therefore recommend that you store your preferred stations in a **Favourites List**, as this makes them easy and fast to access, with no protracted searching. It is also possible to store Internet radio stations as **Presets**, just as you do with normal radio; they can then be called up directly just by entering a number.

The media content can be listed according to various criteria - Internet radio stations e.g. by country of origin, genre or alphabetical, music from media servers e.g. by artiste, album, track, genre, etc.

i The exact form of the displayed list and the preparation of the content also depend to a large extent on the capabilities of the server, i.e. the full facilities of the **K2 Blu** cannot be exploited with all servers or media. You may therefore find that in many cases not all the functions described in these instructions can be used.

Access to Media Content via the Main Menu (Home Menu)

Main Menu (Home-Menu)



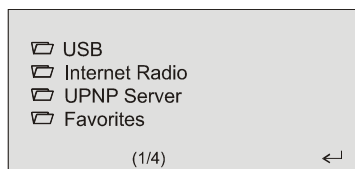

When you call up the Streaming Client by pressing the  /  button, the front panel screen displays a list of accessible media sources:



- USB
- Internet Radio
- UPnP-AV Server (Media-Server) in the local network *)
- Favorites







-  *) To play back media files that are stored on PC's or NAS storage devices on your home network, a UPnP-AV server software must be installed on these devices to make the media content accessible through the network.

Selecting and Playing Media Content

You can now select a device or a service using the  /  buttons. The selected list point is shown enlarged, and can be called up by pressing the  /  button.

The content of the device is displayed in the form of a list. The individual list entries are followed either by a folder symbol () or a note symbol ().



You can now again move to the individual list points using the  /  buttons, and open them with the  /  button.

If the list entry you open is a folder, the screen displays the contents of the folder: you can now navigate further within the new folder.

If the entry is followed by a note symbol, this indicates that the content is playable (pieces of music, playlists, radio station etc.). If you open an entry of this type, its content will be played.

-  The lists and music tracks you can see when you select a device vary according to the machine and the transferred data.

Alpha-Search (Letter Search Function)

When you are navigating through lists you can call up the **K2 Blu** letter search function at any time by briefly pressing the  button. The screen now displays the message 'Search _'. While this is on the screen, enter up to four letters or numerals using the remote control handset; the letters assigned to the numeric buttons are printed below the buttons. To obtain a particular letter, press the appropriate button repeatedly until the correct letter appears on the screen. Before entering the next character you have to wait until the cursor is displayed again. After pressing the  button or after a brief delay with no further input the **K2 Blu** moves to the first entry in the list which starts with the characters you entered. If the text searched for is not found the best matching result will be shown. You can abort the search using the -button.

Select Repeat functions





Repeated **brief presses** cycle through the repeat functions:

→ Rpt Trk ( 1), → Rpt All(), → Normal

- | | |
|----------------|----------------------------------------------------------------------|
| Rpt Trk | The current piece is repeated |
| Rpt All | All pieces in the current folder / the current playlist are repeated |
| Normal | Repeat function switched off |

Long press: Switches **Mix mode** (Shuffle) ON and OFF

Subsequent brief button presses will cycle through the Mix Repeat operating modes:

→ Mix (), → Rpt Trk ( 1), → Rpt Mix()

In Mix mode the pieces are played in a random order.

Accessing Media Content using the Favourites List

The Favourites List

The Favourites list can be used to store your preferred Internet radio stations and the paths to your preferred music tracks. At any subsequent time you can then very quickly access these stations and tracks using the 'Favorites' entry in the Home Menu.





Adding Favourites to the List

If you are currently enjoying a particular Internet radio station, simply press the green  button on the FM100 handset: this adds the station to the Favourites list.





In principle you can also add pieces from a NAS server or a USB hard disc to your Favourites list, but we only recommend this if the content of the relevant storage medium is available at all times (e.g. permanently connected USB hard disc).

Calling up Favourites

Open the Favourites list using the  button, then select an entry from the list using the  /  buttons. Start the track or the station by pressing the  /  button.

Erasing Favourites

Entries are removed from the Favourites list by first selecting the entry to be erased using the  /  buttons, and then holding the red  button on the FM100 handset pressed in for several seconds.



Caution!



Erase the paths to files on USB hard discs or UPnP-AV servers from the Favourites list using the  button before you erase or move files.



Using Presets

Preset function



You can store Internet radio stations as **Presets** using the process familiar from VHF radio. These stations can subsequently be called up directly using the numeric buttons on the FM100 remote control handset.

Storing a Preset

First select an Internet radio station (e.g. using the Home menu / Internet radio). When you hear the station, press the  button followed by a number  to . The station is now stored under this number.

It is possible to store a total of ten Presets under the numbers  to .

Calling up a Preset

Briefly press one of the numeric buttons  to . The associated Preset is now called up, and after a brief delay you will hear it.



Presets are particularly useful when the front panel screen is not in view, but you wish to call up stations (e.g. when operating the system from an adjacent room, or when operating it via a domestic control system).

Adding Internet Radio Stations



The lists of Internet radio stations displayed by the **K2 Blu** are very complete and comprehensive, but since new stations are constantly being added you may find that one of your favourite stations is not (yet) included in the Select lists.

In this case you can add the stations using the vTuner service (see also the Chapter '**vTuner Premium Service**'). The station added can then be accessed from the **K2 Blu** main menu under the Internet Radio / Added Stations point.

Operating the iPod

Once you have used the lead supplied to connect the **K2 Blu** to the iPod, you can operate its basic functions using the buttons on the remote control handset or the front panel. While the iPod is in use, its integral screen provides information on the track currently playing, and the iPod's operating status. When an iPod is inserted in the Dock, its battery is automatically recharged.

Selecting the iPod as source

Select the iPod as source by pressing the  button on the remote control handset ( front panel button) (you may have to press several times).

The iPod is now displayed on-screen as the source device.



The iPod as audio source

Information on the piece of music being played is displayed on the iPod's integral screen. We recommend that you leave the iPod's screen backlight switched on permanently to ensure that it is clearly legible.

The behaviour and method of operating the iPod are determined by the iPod itself. In general terms the function of the buttons of the K2 Blu or the FM100 remote control handset are as follows:

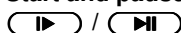
Start and pause playback



The  /  buttons on the remote control handset or the front panel are used to start and pause playback on the iPod (PLAY / PAUSE function).



Stop playback



Pressing the  button halts iPod playback and unloads the playlist.

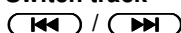

Switch track

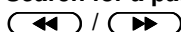

A brief press on the  /  buttons during playback causes the iPod to jump to the next or previous piece of music within the current playlist.

Search for a passage



The  /  buttons on the remote control handset can be used to search for a passage within the current piece of music (fast forward / rewind)

Select Repeat functions



A brief press on the  button on the remote control handset leafs through the iPod's various repeat functions in turn: Icons on the iPod indicate the currently selected mode.

Select Shuffle functions



A brief press on the  button on the remote control handset leafs through the iPod's random functions in turn. Icons on the iPod indicate the currently selected mode.

Menu navigation



Returns to previous point / to the next higher menu level



Confirms input / Selecting a menu point



Selects the previous point within a list



Selects the next point within a list



Confirmation button when entering data

The iPod as video source

The fundamental rule is that the **K2 Blu** can reproduce the video content stored on some iPod models on a screen connected to the system, as well as music.

The method of operating the iPod when playing video material varies slightly from model to model, and it is possible that not all video functions will be supported.

If you cannot access all the video functions of your iPod using the remote control handset, or if you only have remote control of the audio functions, then we recommend that you use the iPod's controls to operate the system.

i The iPod must generate the video content in the form of a standard video signal (CVBS). You may need to change the video output at the iPod.

If you are using the HDMI output for BD / DVD playback, you will also need to connect a standard video lead between the K2 Blu's VIDEO OUT / CVBS output and the video monitor in order to play iPod video files.

For playing iPod video material select the AV input on your video monitor to which this video lead is connected.

Use with an iPhone

The **K2 Blu** can also be used with an iPhone as source device.



i Many models generate a warning regarding telephone use, but this is not relevant to the **K2 Blu**, and can be ignored.



Special features when operating an iPhone

The first step is to select the iPhone as source with a long press on the **SCL** button (); the iPhone must then be unlocked. For safety reasons this cannot be carried out using the remote control handset - please use the slider on the iPhone screen.

The iPod function of the iPhone can be activated by pressing the right-hand cursor button (). This causes the main menu of the iPod module to be displayed on the iPhone's integral screen.

In the main menu of the iPod module the playback category (Lists, Interpret, Track, Video, etc.) can be selected using the left-hand cursor button ().

Within the lists you can navigate up and down using the  and  buttons.

Press the  button to make a selection; pressing the  button takes you back one menu level.

iPod playback with the Streaming Client

In addition to the option of connecting an iPod to the 'iPod' connector, it is possible to connect it to the 'USB Audio' socket of the source 'Streaming Client'. This configuration therefore only permits pure audio playback. The iPod has not longer its own source; instead it features in the list of available streaming client media and devices. In this mode navigation and operation of the iPod are carried out exclusively via the K2 Blu's 'Streaming Client' source. The iPod is operated in the same way as described in the operating instructions for the streaming client.



i Please note that the **K2 Blu** supports only one connected iPod. Connecting two devices may cause fail functions.

Operating the Bluetooth source

The **K2 Blu**'s integral Bluetooth interface provides a means of transferring music wirelessly from devices such as smart-phones, tablet PCs, etc. to the **K2 Blu**.

- ❗ For a successful audio Bluetooth transfer from a mobile device to the **K2 Blu** the mobile device must support the A2DP Bluetooth audio transfer protocol.

Selecting the Bluetooth Audio source

Select the 'Bluetooth' source by repeatedly pressing the  button on the remote control handset, or the  button on the **K2 Blu**'s front panel.

The machine's integral screen now displays 'Bluetooth' as source.

Setting up audio transfer

Before music from a Bluetooth-capable device can be played through the **K2 Blu**, the external device must first be registered to the **K2 Blu**. As long as the **K2 Blu** is switched on and no device is connected, it is always ready to receive. In this state the screen displays the message 'not connected'.

This is the procedure for establishing a connection:

- Start a search for Bluetooth equipment on your mobile device.
- When it finds the **K2 Blu**, make the connection to your mobile device.

Once the connection is successfully established, the message on the **K2 Blu**'s screen switches to 'connected to *YOUR DEVICE*'.

- ❗ If your device requests a PIN code, this is always '0000'.
- ❗ The procedure for establishing a connection can only be made if the Bluetooth source is activated (see chapter '**System settings**' / source name).
- ❗ Due to the large number of different equipment on the market, we are only able to provide a general description for setting up the radio connection. For detailed information please refer to the operating instructions supplied with your device.



Playback functions

Information on the piece of music being played is displayed on the integral screen of the connected mobile device. If possible we recommend that you leave the screen backlight switched on permanently to ensure that it is clearly legible.

The behaviour and method of operating the connected mobile device are determined by the device itself. In general terms the function of the buttons of the **K2 Blu** or the FM100 remote control handset are as follows:

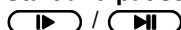
Start and pause playback



The  /  buttons on the remote control handset or the front panel are used to start and pause playback (PLAY / PAUSE function).

Stop playback



Pressing the  button halts playback.

Switch track



A brief press on the  /  buttons during playback causes the device to jump to the next or previous piece of music within the current playlist.

- ❗ Please note that many AVRCP-capable mobile devices do not support the controlling through the **K2 Blu**. In case of doubt, please ask the manufacturer of your mobile device.



Controlling the K2 Blu

The **K2 Blu** can also be controlled from the mobile device (Start/Stop, Pause, Volume, etc.). To control the **K2 Blu** the mobile device must conform to the Bluetooth AVRCP protocol.

- ❗ Please note that many AVRCP-capable mobile devices do not support all the **K2 Blu**'s control functions. In case of doubt, please ask the manufacturer of your mobile device.

Volume adjustment

To achieve the best possible playback quality, you should only adjust the volume on the K2 Blu itself: set the playback volume as high as possible on your mobile device, but not so high that the signal is distorted.

Any further changes to volume should then be made using the  /  button on the K2 Blu or the FM 100.

NOTES



The **K2 Blu** has been tested with a large number of Bluetooth-capable mobile devices. However, we are unable to guarantee general compatibility with all devices available commercially since the range of equipment is so wide, and the various implementations of the Bluetooth standard differ widely in some cases. If you encounter a problem with Bluetooth transfer, please contact the manufacturer of the mobile device.

The maximum range of a Bluetooth audio transfer is normally about 3 to 5 metres, but the effective range may be affected by a number of factors. To achieve good range and interference-free reception there should be no obstacles or persons between the **K2 Blu** and the mobile device.

Bluetooth audio transfers take place in what is known as the “everyman frequency band”, in which many different radio transmitters operate - including WLAN, garage door openers, baby intercoms, weather stations, etc. Radio interference caused by these other services may cause brief dropouts or - in rare cases - even failure of the connection, and such problems cannot be excluded. If problems of this kind occur frequently in your environment, we recommend that you use the Streaming Client or the USB input of the **K2 Blu** instead of Bluetooth.

By their nature, Bluetooth transmissions always involve data reduction, and the attainable sound quality varies according to the mobile device in use, and the format of the music to be played. As a basic rule the maximum quality of music which is already stored in a data-reduced format, such as MP3, AAC, WMA or OGG-Vorbis, is worse than with uncompressed formats such as WAV or FLAC. For the highest reproduction quality we always recommend the use of the Streaming Client or the USB input of the **K2 Blu** instead of Bluetooth.

Installation

Using the system for the first time

Safety notes

This section describes all those matters which are of fundamental importance when setting up and first using the equipment. This information is not relevant in daily use, but you should nevertheless read and note it before using the equipment for the first time.

Connections

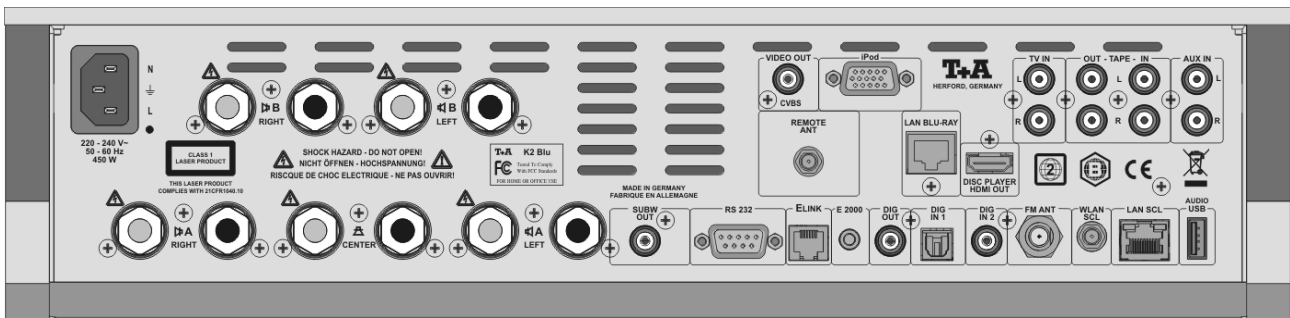

Mains input

The mains lead is plugged into this socket.

For correct mains connection please read the notes in the chapters ‘Using the system for the first time, Wiring’ and ‘Safety Notes’.

A, B and C (LS terminals)

The primary pair of loudspeakers is connected to the **A** loudspeaker output. The impedance of each speaker must be at least 4 Ω. It is important to enter the size of your loudspeakers correctly in the ‘Loudspeaker settings’ menu (chapter ‘System settings, Loudspeakers’).

i If you are using mini-loudspeakers (known as Satellite speakers) as your main loudspeakers, it is really essential to include a sub-woofer in the system.

A Centre loudspeaker is optional.

If you connect a Centre speaker, the **K2 Blu** automatically detects its presence. Enter the appropriate settings for Centre mode in the ‘Loudspeaker settings’ menu (chapter ‘System settings, Loudspeakers’).

If the Centre loudspeaker is not detected automatically, please read the notes in the chapter entitled ‘Trouble-shooting, Sound’.

The speakers set up in the neighbouring room or the second listening zone should be connected to the **B** loudspeaker output (Remote Speaker). Please note that the impedance of each speaker should be no lower than 4 Ω.

If Loudspeakers B are not detected automatically, please read the notes in the chapter entitled ‘Trouble-shooting, Sound’.



Caution!

It is important to tighten the screw-terminals firmly, and to eliminate stray strands of wire which could cause short-circuits.



If you are using the system outside the countries of the EU, you can remove the red / black stoppers from the loudspeaker terminals. The speakers can then be connected using banana plugs.

The stoppers are only a push-fit, and can easily be levered out of the rear of the terminals using a suitable tool, such as a knife blade.

The **T+A** accessory range includes a range of high-quality cables which are an exact match to **T+A** equipment.

SUBW OUT

Output socket for an active sub-woofer. The sub-woofer is optional.



If your system includes a sub-woofer, it must be switched on in the loudspeaker menu (see chapter ‘System settings, Loudspeaker’).



If **no** sub-woofer is present, it is important to disable the sub-woofer in the loudspeaker menu (see chapter ‘System settings, Loudspeaker’). The correct setting is ‘Ext. sub-woofer off’.

If the sub-woofer is not disabled in the ‘Loudspeaker settings’ (chapter entitled ‘System settings’), the low-frequency range will be missing from the sound since no sub-woofer is present to reproduce it.

VIDEO OUT / CVBS	Output socket for connecting a video monitor with Composite (FBAS) signal input. The video signals from a video-capable iPod connected to the system are present at this output.
iPod	Socket for an iPod (an adapter lead is included in the accessory pack). i When an iPod is connected and the K2 Blu is switched on, its battery is automatically recharged.
DISC PLAYER HDMI OUT	HDMI output for Plasma / LCD panel or projector. The video and audio signals of the internal Blu-ray / DVD player can be made available at this output.
LAN BLU RAY	Socket for a wired network (LAN). i For BD Live please connect a LAN cable with internet access. If you do not wish to use BD Live, there is no need to connect a wired network.
TV IN	Sound input for TV sound reproduction.
TAPE OUT / TAPE IN	Sockets for an audio recorder (Tape, DAT, etc.).
AUX IN	Universal pre-amplifier input.
REMOTE ANT	Socket for the aerial of the integral radio remote control module, for communicating with the optional T+A FD 100 radio remote control handset. i If you intend to use the machine without the FD 100 , then this socket can be left unused.
RS 232	Software update interface i This port can also be used to provide control of device functions from a computer, making it possible to control the K2 Blu remotely using a home automation system such as those made by CRESTRON, AMX, etc. For external control the K2 Blu must be equipped with special software. For detailed information regarding the RS 232 interface, protocols and command lists please refer to the Technology and Download area of the T+A website: http://www.taelektroakustik.de .
ELINK	Control output socket for the T+A E LINK – system.
E2000	Input socket for the T+A E 2000 remote control receiver for use in a neighbouring room.
DIG OUT	Digital co-axial output for connecting an external digital / analogue converter using a co-ax lead. i It is not always possible to produce a digital version for all media, as in some cases the original contains copy protection measures which prevent this. The digital output from the analogue sources AUX IN, TV IN and TAPE IN is also not possible.
DIG IN 1 / DIG IN 2	Inputs for digital source devices with optical or co-ax digital output (SP-DIF). Supported sample rates are: Up to 96 kHz at DIG IN 1 and 192 kHz at DIG IN 2. i If required, one of these inputs can be assigned to the TV source. (see chapter 'System settings > Audio inputs')
FM ANT (aerial input)	The K2 Blu features a 75 Ω aerial input FM ANT , which is suitable both for a normal domestic aerial and a cable connection. For first-class reception quality a high-performance, professionally installed aerial system is indispensable.

WLAN SCL

Aerial socket for receiving WLAN signals.

The aerial can be unscrewed from the aerial base and screwed directly into the socket.



Automatic activation of the WLAN module

Every time you switch the **K2 Blu** on, the machine checks whether it is connected to a wired Ethernet or Powerline network via its LAN socket (see below).

If it finds no connection to a wired network, the **K2 Blu** activates its WLAN module and attempts to connect to a radio network.



Caution!

The LAN socket must be left vacant if you are using a WLAN connection.

LAN SCL

Socket for a wired network (LAN).



If a LAN is connected, the LAN connection has priority, and the WLAN is disabled.

AUDIO USB

Socket for a USB memory stick, an external hard disc or an iPod.

Files from a medium connected to this socket are reproduced via the Streaming Client (SCL). Only audio files can be played in this way.

The storage medium must be formatted using the FAT16 or FAT32 file system.

The USB storage medium can be powered directly via the USB port provided that its current drain is in accordance with the USB norm. Normalised 2.5" USB hard discs can be connected directly, i.e. without a separate mains PSU.

Listening zones and bi-amping

The **K2 Blu** can provide a signal to two supplementary speakers (loudspeaker group B) in addition to the primary speakers (loudspeaker group A).

There are two possible operating modes for these loudspeakers:

One-room mode with two listening areas

The volume of the group B speakers is controlled in tandem with the main loudspeakers. A typical use for this mode of operation would be for providing sound in a second listening zone (e.g. dining area) in the same room. It is possible to set a difference in level between loudspeaker groups A and B using the FADER function (see the chapter entitled "Tone settings"), if you find that the volume needs to be reduced slightly in one of the zones. Groups A and B can also be switched on and off separately, so that you can restrict the music to one zone at any one time.

One-room mode with bi-amping

One-room mode is an excellent choice for the arrangement known as bi-amping. This involves setting up separate amplifiers and separate speaker leads to feed the bass and mid-range / high-frequency systems of your loudspeakers, and provides a further improvement in sound quality. Bi-amping is only possible if the loudspeakers are equipped with bi-wiring terminals.

In a bi-amping arrangement the bass drive units of the loudspeakers connected to the system are connected to the loudspeaker output B terminals, and the mid-range / high-frequency drive units to the loudspeaker output A terminals (see 'Appendix A'). For bi-amping operation you should set the FADER to 0, and select the stereo mode of operation (without Centre speaker).

Two-room mode

In this mode the volume level of group B is controlled independently of group A. To accomplish this it is necessary to connect the E2000 remote control receiver (included in the accessory pack) to the **K2 Blu**, and install it in the adjacent room. If you now alter the volume in the adjacent room using the remote control handset, the change only affects the volume of loudspeaker output B; the volume level in the primary room is unchanged. Loudspeaker output B can only be switched on and off using the remote control handset in the adjacent room.



If the FD 100 is used to control the system, you can use the  button on the handset to switch between control of the groups (listening zones). (See chapter entitled 'FD 100 Radio Remote Control'.)

Installation and wiring

Carefully unpack the **K2 Blu** and store the original packing materials carefully. The carton and packing are specially designed for this unit and will be needed again if you wish to move the equipment at any time.

Please be sure to read the safety notes in these instructions.

If the unit gets very cold (e. g. when being transported), condensation may form inside it. Please do not switch it on until it has had plenty of time to warm up to room temperature, so that any condensation evaporates completely.

Before placing the unit on a sensitive surface, please check the compatibility of the lacquer and the unit's feet at a non-visible point.



The unit should be placed on a rigid, level base.

The quality and characteristics of the base on which your high-quality Hi-Fi equipment stands define the limits of sound quality which can be achieved. The base surface should be as heavy, rigid, hard and level as possible. Make sure there are no loose objects on the support surface which could cause rattling noises or resonance effects.

The receiver should be set up in a dry, well-ventilated site, out of direct sunlight and away from radiators.

The unit must not be located close to heat-producing objects or devices, or anything which is heat-sensitive or highly inflammable.

When installing the unit on a shelf or in a cupboard it is essential to provide an adequate flow of cooling air, to ensure that the heat produced by the unit is dissipated effectively. Any heat build-up will shorten the life of the unit and could be a source of danger. Be sure to leave at least 10 cm free space above the unit for ventilation. If the system components are to be stacked then the amplifier must be the top unit. Do not place any object on the top cover.

Mains and loudspeaker cables, and also remote control leads must be kept as far away as possible from signal leads and antenna cables. Never run them over or under the unit.

A complete connection diagram is shown in '**Appendix A**'.



Notes on connections:

- Be sure to push all plugs firmly into their sockets. Loose connections can cause hum and other unwanted noises.
- When you connect the input sockets of the amplifier to the output sockets on the source devices always connect like to like, i. e. '**R**' to '**R**' and '**L**' to '**L**'. If you fail to heed this then the stereo channels will be reversed.
- To achieve maximum possible interference rejection the mains plug should be connected to the mains socket in such a way that phase is connected to the mains socket contact marked with a dot (●). The phase of the mains socket can be determined using a special meter. If you are not sure about this, please ask your specialist dealer.

We recommend the use of the **T+A 'POWER LINE'** ready-to-use mains lead in conjunction with the '**POWER BAR**' mains distribution panel, which is fitted with a phase indicator as standard.

When you have completed the wiring of the system please set the volume control to a very low level before switching the system on.

The screen on the **K2 Blu** should now light up, and the unit should respond to the controls.

If you encounter problems when setting up and using the amplifier for the first time please remember that the cause is often simple, and equally simple to eliminate. Please refer to the section of these instructions entitled '**Trouble shooting**'.

Loudspeaker and signal cables

Loudspeaker cables and signal cables (inter-connects) have a significant influence on the overall reproduction quality of your sound system, and their importance should not be under-estimated. For this reason **T+A** recommends the use of high-quality cables and connectors.

Our accessory range includes a series of excellent cables and connectors whose properties are carefully matched to our speakers and electronic units, and which harmonise outstandingly well with them.

For difficult and cramped situations the **T+A** range also includes special-length cables and special-purpose connectors (e. g. right-angled versions) which can be used to solve almost any problem concerning connections and system location.

Mains cables and mains filters

The mains power supply provides the energy which your sound system equipment needs, but it also tends to carry interference from remote devices such as radio and computer systems.

Our accessory range includes the specially shielded '**POWER FOUR**' mains cable, ready-to-use '**POWER LINE**' mains cable with integrated shell-type filters and the '**POWER BAR**' mains filter distribution board which prevent electro-magnetic interference from entering your Hi-Fi system. The reproduction quality of our systems can often be further improved by using these items.

If you have any questions regarding cabling please refer to your specialist **T+A** dealer who will gladly give you comprehensive expert advice without obligation. We would also be happy to send you our comprehensive information pack on this subject.

Changing the batteries

The battery compartment can be opened by pressing in the locking surface and sliding the cover down and off. Remove the old cells and fit two new dry cells of the **LR 03 (MICRO)** type in the battery compartment, taking care to fit them with correct polarity. Please remember that **all the cells must be replaced** at the same time.



Caution!

Batteries should not be exposed to excessive heat like sunshine, fire or the like.



Disposing of exhausted batteries:

Exhausted batteries must never be thrown into the household waste! They should be returned to the battery vendor (specialist dealer) or your local toxic waste collection point, so that they can be recycled or disposed in a proper way. Most local authorities provide collection centres for such waste, and some provide pick-up vehicles for old batteries.

Care of the unit:

Always disconnect the unit from the mains supply before cleaning it.

The surfaces of the case should be wiped clean with a soft, dry cloth only.

Never use solvent-based or abrasive cleaners!

Before switching the unit on again, check that there are no short-circuits at the connections, and that all cables are plugged in correctly.

Safety notes

All the components in this device fulfil the currently valid German and European safety norms and standards.

We ensure that our products are of consistently high quality, and meet all specifications, by checking all materials rigorously for quality, using meticulous production methods and subjecting each unit to a fully automatic computer-controlled final inspection.

For your own safety please consider it essential to read these operating instructions right through, and observe in particular the notes regarding setting up, operation and safety.

Installation

The unit must be set up in such a way that none of the connections can be touched directly (especially by children). Be sure to observe the notes and information in the section '**Installation and Wiring**'.

Power supply

The power supply required for this unit is printed on the mains supply socket. The unit must never be connected to a power supply which does not meet these specifications. If the unit is not to be used for a long period disconnect it from the mains supply at the wall socket.

Mains leads / Mains plug

Mains leads must be deployed in such a way that there is no danger of damage to them (e.g. through persons treading on them or from furniture). Take particular care with plugs, distribution panels and connections at the device.

Unplugging the mains plug will disconnect the device from the mains for service and repair. Please make sure that the mains plug is easily accessible.

Enclosure openings

Liquid or particles must never be allowed to get inside the unit through the ventilation slots. Mains voltage is present inside the unit, and any electric shock could cause serious injury or death. Never exert undue force on mains connectors.

Protect the unit from drips and splashes of water; never place flower vases or fluid containers on the unit.

Supervision of device operation

Like any other electrical appliance this device should never be used without proper supervision. Take care to keep the unit out of the reach of small children.

Service, Damage

The case should only be opened by a qualified specialist technician. Repairs and fuse replacements should be entrusted to an authorised **T+A** specialist workshop. With the exception of the connections and measures described in these instructions, no work of any kind may be carried out on the device by unqualified persons.

If the unit is damaged, or if you suspect that it is not functioning correctly, immediately disconnect the mains plug at the wall socket, and ask an authorised **T+A** specialist workshop to check it.

Over voltage

The unit may be damaged by excess voltage in the power supply, the *mains circuit* or in aerial systems, as may occur during thunderstorms (lightning strikes) or due to static discharges.

Special power supply units and excess voltage protectors such as the **T+A 'Power Bar'** mains distribution panel offer some degree of protection from damage to equipment due to the hazards described above.

However, if you require absolute security from damage due to excess voltage, the only solution is to disconnect the unit from the mains power supply and any aerial systems.

To avoid the risk of damage by overvoltages we recommend to disconnect all cables from this device and your HiFi system during thunderstorms.

All mains power supply and aerial systems to which the unit is connected must meet all applicable safety regulations and must be installed by an approved electrical installer.



Many insurance companies offer lightning damage insurance for electrical equipment as part of their household insurance service.

Approved usage

This device is designed exclusively for reproducing sound and/or pictures in the domestic environment. It is to be used in a dry indoor room which meets all the recommendations stated in these instructions.

Where the equipment is to be used for other purposes, especially in the medical field or any field in which safety is an issue, it is essential to establish the unit's suitability for this purpose with the manufacturer, and to obtain prior written approval for this usage.

T+A equipment which includes a radio or television receiving section must be operated within the stipulations laid down by the Post Office and the Telecommunications authorities in the country in which it is used.

This unit may only be used to receive or reproduce those transmissions which are intended for public reception. The reception or reproduction of other transmissions (e. g. police radio or mobile radio broadcasts) is prohibited.

Approval and conformity with EC directives

In its original condition the unit meets all currently valid European regulations. It is approved for use as stipulated within the EC.

By attaching the CE symbol to the unit **T+A** declares its conformity with the EC directives 2006/95/EC and 2004/108/EC and the national laws based on those directives.

The original, unaltered factory serial number must be present on the outside of the unit and must be clearly legible! The serial number is a constituent part of our conformity declaration and therefore of the approval for operation of the device.

The serial numbers on the unit and in the original **T+A** documentation supplied with it (in particular the inspection and guarantee certificates), must not be removed or modified, and must correspond.

Infringing any of these conditions invalidates **T+A** conformity and approval, and the unit may not be operated within the EC. Improper use of the equipment makes the user liable to penalty under current EC and national laws.

Any modifications or repairs to the unit, or any other intervention by a workshop or other third party not authorised by **T+A**, invalidates the approval and operational permit for the equipment.

Only genuine **T+A** accessories may be connected to the unit, or such auxiliary devices which are themselves approved and fulfil all currently valid legal requirements.

When used in conjunction with auxiliary devices or as part of a system this unit may only be used for the purposes stated in the section '**Approved usage**'.

Disposing of this product



The only permissible method of disposing of this product is to take it to your local collection centre for electrical waste.

FCC Information to the user

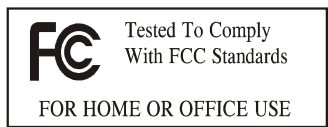

(for use in the United States of America only)

Class B digital device – instructions:

Note: This equipment has been tested and found to comply with the limits for a Class B digital device, pursuant to Part 15 of the FCC Rules. These limits are designed to provide reasonable protection against harmful interference in a residential installation. This equipment generates, uses and can radiate radio frequency energy and, if not installed and used in accordance with the instructions, may cause harmful interference to radio communications. However, there is no guarantee that interference will not occur in a particular installation. If this equipment does cause harmful interference to radio or television reception, which can be determined by turning the equipment off and on, the user is encouraged to try to correct the interference by one or more of the following measures:

- Reorient or relocate the receiving antenna.
- Increase the separation between the equipment and receiver.
- Connect the equipment into an outlet on a circuit different from that to which the receiver is connected.
- Consult the dealer or an experienced radio/TV technician for help.

Network Configuration

General Information

The **K2 Blu** can be operated in wired LAN networks (*Ethernet LAN* or *Powerline LAN*) or in wireless networks (*WLAN*).

If you wish to use your **K2 Blu** in your home network, you must first enter the necessary network settings on the **K2 Blu**. This includes entering the network parameters such as the IP address etc. both for wired and wireless operation. If you wish to use a wireless connection, a number of additional settings for the WLAN network also have to be entered.

Please refer to the Chapter '**Glossary / Additional Information**' and '**Network Terms**' for additional explanations of terminology relating to network technology.



In the following sections we assume that a working home network (cable network or WLAN network) with router and (DSL) Internet access is present.

If you are unclear about some aspect of installing, setting up and configuring your network, please address your queries to your network administrator or a network specialist.

Compatible hardware and UPnP servers

The market offers a vast number of routers, NAS devices and USB hard discs made by a huge variety of manufacturers. **T+A** devices are generally compatible with other makes of machine which bear the UPnP label. A list of units which **T+A** has checked for compatibility can be found on the Internet under http://www.taelektroakustik.de/hardware/comp_lan_hw.pdf.

Network Configuration Menu

All network settings are entered in the Network Configuration menu. This menu will vary slightly in appearance depending on the type of your network, i.e. whether you have a wired (LAN) or wireless (WLAN) network.



If in the Network Configuration Menu the entry 'Network IF Mode' is set to 'auto', the **K2 Blu** will check automatically if a LAN connection to a network is present. If a LAN connection is found, the machine will assume that this is to be used, and displays the network configuration menu for LAN networks.

If no LAN network is connected, the **K2 Blu** activates its WLAN module and displays the WLAN configuration menu when you call up the configuration menu. The menu for a WLAN network includes a number of additional menu points. The following sections explain how to use the menu, and the meaning of the individual menu points.





The Network IF Mode 'auto' is the default factory setting. In case of problems in combination with your hardware this automatic function can be switched to a fixed operation mode, e.g. only LAN.





Opening the Network Configuration Menu

First select the **K2 Blu** Streaming Client function by pressing the  /  button.
Open the configuration menu with a long press on the  button on the FM100 remote control handset. You should now see the configuration menu on the front panel screen.

Operating the Menu, Changing and Storing IP Addresses



Use the  /  buttons in the menu to select the network parameter to be changed, and activate the entry with the  button.



You can now change the setting using the following buttons, depending on the type of setting:

 /  button for simple selection (ON / OFF)
Numeric buttons  to  for entering IP addresses
Alpha-numeric input for entering text

When the setting process is complete, or when you have entered the complete address, press the  button to confirm your action.

Alpha-numeric entry

At certain points, e.g. for entering server names or passwords, it is necessary to input series of characters (strings). At such points you can enter letters, numbers and special characters by repeatedly pressing the numeric buttons on the FM100 remote control handset, as when writing SMS news. The assignment of letters to the buttons is printed below the buttons. Special characters can be accessed using the  and  buttons:

 0 + - * / ^ = { } () [] < >
 . , ? ! : ; ' \ " ' _ @ \$ % & # ~



Use the blue  button for toggling between numbers, capitals and lower-case letters. The bottom line of the screen shows which input mode is currently selected.

 At certain points (e.g. DNS server name) it is possible to enter both an alpha-numeric string and an IP address. At these points an IP address should be entered like a string (with separating dots as special characters). In this case an automatic check for valid address ranges (0 ... 255) is not carried out.

Closing the Menu



Once you have correctly set all the parameters, select the menu point '**Save and Restart**', then press the  button. This action causes the **K2 Blu** to accept the settings, and the machine restarts with the new network settings. After the restart you should see the available network media sources (Internet radio, UPnP-AV server, etc.) displayed in the main menu.









Interrupting the Menu without Storing the Settings



At any time you can leave the network configuration menu without making any changes to the network settings: this is done by pressing the  button, which takes you to the menu point '**Exit without saving**'. Pressing the  button at this juncture interrupts and closes the menu.

The Configuration for a Wired Ethernet LAN or Power-Line LAN connection

Setting the Parameters for a Wired Network

- Connect the **K2 Blu** to an operational network or Power-Line modem using the LAN socket on the back panel.
- Switch the **K2 Blu** on, and select the Streaming Client function by pressing the  /  button.
- Call up the Configuration menu as described above. You should now see the menu reproduced below, displaying the network parameters. In the title line the message '**LAN**' should appear, indicating that the machine is connected to a wired LAN. If you see '**WLAN**' at this point instead, please check your network connection, and ensure that the network is switched on and operational.
- You can now select the individual menu points and adjust them to match your network conditions. The illustration below shows the possible button inputs after each menu point..

Network Parameter (LAN)		Possible entries
MAC	00:0e:9b:cc:a4:35	none
 DHCP	Off	 / 
Device IP	192.168.0.10	(0 ... 9)
IP mask	255.255.255.0	(0 ... 9)
Gateway IP	192.168.0.1	(0 ... 9)
DNS 1	192.168.0.1	(0 ... 9, A ... Z)
DNS 2	0.0.0.0	(0 ... 9, A ... Z)
Proxy	XXX	 / 
Proxy IP	192.168.0.1	(0 ... 9, A ... Z)
Proxy port	8080	(0 ... 9)
Device Name	K2 blu	(0 ... 9, A ... Z)
Network IF Mode	Auto	 / 
Save and restart	Apply	
Exit without saving	Apply	

-  / : Switching ON / OFF
- (0...9): Numeric input, separating dots are automatically generated; input limited to valid addresses
- (0...9, A...Z): Alpha-numeric input and special characters.
IP - separating dots must be entered as special characters.









 The parameters illustrated above are only typical values. Addresses and settings may require different values for your network.

Menu Point	Description
MAC	The MAC address is a hardware address which uniquely identifies your machine. The address displayed is determined by the manufacturer, and cannot be altered.
DHCP	<p>ON</p> <p>If your network includes a DHCP server, please select the ON setting at this point. In this mode an IP address is automatically assigned to the K2 Blu by the router. The screen shows only the MAC address and the message DHCP state ON. In this case the address input fields shown in the illustration do not appear in the menu.</p> <p>OFF</p> <p>If your network does not include a DHCP server, please select the OFF setting. In this mode you must configure the following network settings manually. Please ask your network administrator for the addresses to be entered for your network.</p>
Device IP	IP address of the K2 Blu
IP mask	Network mask
Gateway IP	IP address of the router
DNS 1	Name / IP of the name server (optional)
DNS 2	Alternative name server (optional)
Proxy state	ON if a proxy server is present, otherwise OFF
Proxy IP	Address of the proxy server
Proxy port	Port number of the proxy server
Dev. Name	User-selected name under which the device appears in the network
Network IF Modus	Networksetting: only WLAN, only LAN or automatic setting
Save and Restart	Stores the network parameters, and restarts the K2 Blu with the new settings.
Exit without saving	Closes the menu: data already entered is discarded.

The Configuration for a WLAN connection

Setting the Parameters for a Radio Network

- Connect the WLAN aerial (supplied) to the **K2 Blu** WLAN aerial socket, and ensure that no cable is attached to the **K2 Blu** LAN socket.
- Switch the **K2 Blu** on, and select the Streaming Client function by pressing the  / **SCL** button.
- Now call up the Configuration menu as described above: with a long press on the **src** button. You should now see the menu reproduced below, displaying the network parameters.

Network Parameter (WLAN)		Possible entries
MAC	00:0e:9b:cc:a4:35	
⇒ WLAN configuration	start	none
DHCP	Off	 / 
Device IP	192.168.0.10	(0 ... 9)
IP mask	255.255.255.0	(0 ... 9)
Gateway IP	192.168.0.1	(0 ... 9)
DNS 1	192.168.0.1	(0 ... 9, A ... Z)
DNS 2	0.0.0.0	(0 ... 9, A ... Z)
Proxy	XXX	 / 
Proxy IP	192.168.0.1	(0 ... 9, A ... Z)
Proxy port	8080	(0 ... 9)
Device Name	K2 blu	(0 ... 9, A ... Z)
Network IF Mode	Auto	 / 
Save and restart	Apply	
Exit without saving	Apply	

Searching for and Selecting the Network

First select the menu point **'WLAN configuration start'**, and activate it by pressing the  button.

A menu appears showing these points:

- Rescan - initiates new search for accessible radio networks
- Set manually - adding a WLAN manually

After a brief delay the networks present in the vicinity are listed on the screen.

List of WLANs

⇒ Rescan

Set manually

XXXXX (name of network)

(1/3)

You can use the 'Rescan' function to start a new search for networks present in the vicinity.

Please select one of the networks located, and activate it by pressing the  button.



Entering the Password (for encoded networks)

WLAN

⇒ Passphrase

Save Apply

(1/2)

If your network is encoded, the window illustrated above now appears. Please enter the network password and confirm the entry by pressing . Now select the point 'Save WLAN settings' and confirm with .



If a WEP code is used, the password must be entered as a hexadecimal code (0 - 9, A - F).

Please enter the settings for the remaining network parameters as described earlier in the section entitled **'Setting the Parameters for a Wired Network'**.

Storing Network Settings and Restarting

Finally select the menu point 'Save and Restart', and press the  button; this action accepts the settings, and restarts the **K2 Blu** with the new settings.

Special case:
Manual Network Entry

The **K2 Blu** automatically searches for accessible radio networks, and lists them when you call up the menu point 'WLAN Configuration'. However, the **K2 Blu** can only locate networks which broadcast their SSID network identity. For security reasons many radio networks do not transmit the SSID (if you are not sure about this, ask your network administrator). In such cases the network cannot be found and displayed automatically, i.e. it must be set up manually. This is the purpose of the menu point 'Set Manually'. If you select this menu point, you will see the input window reproduced below; you can enter the parameters for your network at this point.

WLAN	
→ Name / SSID	<input type="text"/>
Security	NONE
Passphrase
Save	Apply

(1/4)

After successfully entering all the data, please select the point 'Save WLAN Settings', and confirm by pressing the **OK** button. Your **K2 Blu** now accepts the data you have entered relating to the WLAN network, and moves on to the subordinate menu in which you can set the remaining network parameters, as described earlier in the section entitled '**Setting the Parameters for a Wired Network**'.

You can now leave the Configuration menu by selecting the menu point 'Save and restart'.

The vTuner Premium Service

The list of radio stations displayed by your **K2 Blu** is prepared by an Internet Service Provider, and transferred to your machine by data transfer. You can expand and edit the 'Favourite Groups' and 'Added Stations' list to suit your preferences via the Internet portal of your service provider, using the main menu point 'Internet Radio'. This is the procedure:

Open your Internet browser and call up the following web address:
<http://ta.vtuner.com>

The first time you register you should enter the MAC address (ID#) of your **K2 Blu**; the MAC address provides unique identification of your machine. The MAC address can be found in the Configuration menu (hold the **SRC** button pressed in), and consists of six pairs of characters, e.g.: 00:0e:9b:cc:a4:35. You do not need to enter the separating colons when you enter this data. MAC addresses are in hexadecimal format, i.e. the address consists only of the letters a to f, and the numbers 0 to 9.

Confirm your entry.

The screenshot shows the vTuner website interface. At the top, there are language selection options and a 'My Preferences' link. The main header features the vTuner logo and a 'Logout' button. A 'STATUS' section displays '9754 Stations Available', '9649 Podcasts', and a 'New Stations' link. Below this, there are sections for 'My Favourite Groups' and 'My Added Stations'. The 'My Added Stations' section shows a table with columns for Station Name, Location, Genre, and Stream, with one entry: 'Stellar Attraction' from 'Great Britain' in the 'Rock (Progressive MP3)' genre. There is an 'Add Another Station' button and a search bar. Below the search bar, there are navigation options for 'Browse Stations by Format', 'Browse Stations by Location', and 'Browse Stations by Language'. The 'Browse Stations by Format' section is expanded, showing a grid of music genres and their counts, such as 'Adult Contemporary (1326)', 'Electronic (189)', and 'Show Tunes (3)'. There is also a 'Talk' section with categories like 'Business News (26)', 'News Talk (334)', and 'Scanner (99)'.

You must register with vTuner in order to be able to use the service; you can register via your e-Mail address and a password. Please follow the instructions stated by the service provider.

Now you can select radio stations from the comprehensive inventory provided by vTuner, and store them in lists. The lists are transferred to your **K2 Blu** automatically via your Internet connection. Shortly after you have edited lists on the vTuner page, or stored new stations, you will find that they are available on your **K2 Blu**.

Notes regarding Internet Radio:

- Not all stations are always accessible
 - Not all stations transmit 24 hours
 - Stations are no longer accessible
 - Capacity exhausted
- Transmission breaks off
 - (Internet) network problems
 - Server capacity exhausted

Setting up new Internet Radio Stations

On the vTuner Internet site you can also set up new stations which are not (yet) included in the Select lists. This is accomplished by registering with vTuner and logging on. Click on the point 'My Added Stations'. An input mask appears in which you can enter the data for your station. After a brief period you will be able to access the newly set-up station via the menu system of your **K2 Blu**. You will find the station under Internet Radio / Added Stations.

Finding a Station URL



You require the URL (Internet address) of any radio station you wish to set up on the vTuner service. You will generally find the URL on the station's website.

Another method of finding the URL is to search for it using an Internet searching service such as Shoutcast (www.shoutcast.com). Once you have found your station, click on the 'Tune In' switch: this will normally open your media player, and the station should play. In most cases you can set Media Player to display the 'Streaming Properties'. For example, using the popular Winamp Player, simply right-click on the entry for the currently playing station in the player's Playlist window. A menu now opens, and clicking on the point 'View File Info' opens an information box which displays the streaming properties including the URL.

FD 100 Radio Remote Control

Connecting the radio aerial

The **K2 Blu** is prepared for use with the **FD 100** bi-directional radio control handset. The **FD 100** features an integral full-colour screen which provides a convenient means of controlling virtually all the **K2 Blu** functions, even when there is no direct line-of-sight contact with it. The handset can also display information relating to the selected source or the medium currently playing.

Since the **FD 100** operates by a radio link, an aerial must be connected to the **K2 Blu**. This is plugged into the socket on the **K2 Blu** marked 'Remote ANT'. The aerial should be free-standing in order to obtain maximum effective range.



Please use one of the WLAN aerials supplied in the set; the aerials are identical. If you do not wish to use the FD 100, there is no need to connect a remote aerial.

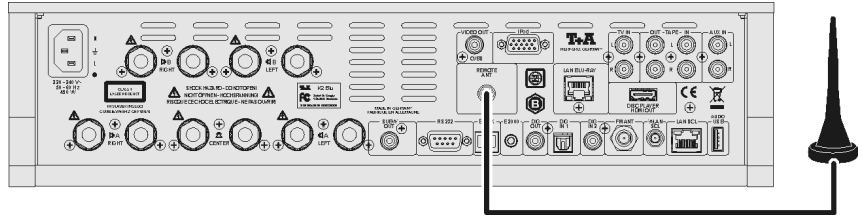

Pairing the FD 100

Before the **K2 Blu** can be controlled using the **FD 100**, the remote control handset must first be registered to the **K2 Blu**. This process is known as pairing, and only has to be carried out once. The procedure is as follows:

- Press the **sys** button on the **K2 Blu** to call up the Configuration menu, then select the 'FD 100 pairing' menu point using the **▼** button.
- To confirm the pairing process of the **FD 100**, press the **ok** button until the menu entry changes to 'waiting for FD 100'. (the function remains active for thirty seconds).
- Locate the **sys** button on the **FD 100** and hold it pressed in to open the **FD 100's** System Settings menu.
- Now select the 'Start pairing' point, and press the **ok** button: the remote control handset automatically seeks the **K2 Blu**.
- Once the device is found, you will see in the display header the on-screen message 'Pairing successful'. At the same time changes the menu entry of the **K2 Blu** to 'Done'. If you wish, you can change the name of the device at this point (eg. 'Living room').
- Confirm the name with the **ok** button.
- For faster access the **K2 Blu** can also be assigned to a Hotkey; this is the next step (see **FD 100** operating instructions).
- Select one - or optionally none - of the 'F' buttons, and confirm your choice by pressing the **ok** button.
- The **FD 100** is now paired with the **K2 Blu**, and is ready



For detailed information on using the **FD 100** please refer to the operating instructions supplied with the remote control handset.

Displaying iPod content on the FD 100 graphic remote control handset

Connecting to the input 'iPod'

Music and video playback

The **K2 Blu** offers two methods of connecting and operating an iPod.

The first connecting method provides a means of playing music content and video content. In this case you carry out navigation tasks on the iPod's screen, and control operations on the K2 Blu or directly on the iPod. In this mode the iPod is displayed as its own source. In this setting the FD 100 can only control the iPod. The iPod itself does not pass any information to the K2 Blu in this mode, for which reason the FD 100 is also unable to display any information.

Connecting to the input 'AUDIO USB'

Music playback only

The second option is to connect the iPod to the Streaming Client (AUDIO USB input), which provides a convenient method of controlling the iPod using the FD 100. In this mode of operation the iPod does pass the information required to the K2 Blu, but in this case video playback via the K2 Blu is not supported by the iPod; this configuration therefore only permits pure audio playback. The iPod no longer appears as its own source; instead it features in the list of available streaming client media and devices. In this mode navigation and operation of the iPod are carried out exclusively via the K2 Blu's 'Streaming Client' source. The iPod is operated in the same way as described in the operating instructions for the streaming client.

i If you wish to see the content and information on the FD100's screen during navigation and playback of the iPod, this is only possible with the second method of connecting (navigation on the K2 Blu's integral screen), as the iPod only provides the information required for the display in this mode.

i The **K2 Blu** can be controlled by the **T+A** App 'TA Control' too. For further information please visit our homepage www.ta-hifi.com/app

Selecting the listening zone in two-room mode

If the FD 100 is used to control the system, you can use the **F3** button on the handset to switch between the listening zones.

The selected zone, the set volume of the active zone and the status of the loudspeaker output are displayed in the status line of the screen.

- 1 Selecting listening zone A or B
- 2 Current volume for the selected listening zone
- 3 Display of the selected listening zone
- 4 The loudspeaker symbol indicates that the loudspeaker output is switched on.

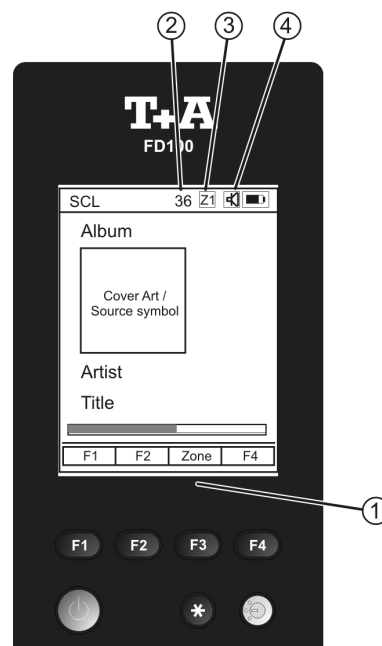

T+A TV Connect

The **K2 Blu** offers the option to integrate certain **LOEWE** or **Metz** TV sets seamlessly into the overall T+A control system.

T+A has developed the **TV Connect** System for this purpose. This connection allows the **K2 Blu** and the TV set to form a functional unit which can be controlled using a single remote control handset.







The **K2 Blu** features intelligent automatic functions which are capable of carrying out many complex operating processes, thereby relieving you of the large number of separate button-presses which would otherwise be required. Your TV set switches itself on automatically when needed, and switches itself off again automatically when no longer required, e.g. because you wish to listen to music from a pure audio source. When you switch between different sources, the **K2 Blu** automatically switches your TV set to the appropriate video input, thereby sparing you the tedious task of switching between AV inputs.

Activating optional functions

The **K2 Blu** features the facility to release optional (extra-cost) functions by entering a four-digit code, such as the gapless function.*

This is the procedure for entering the code:

Activating optional functions (code entry)

- Switch the machine on using the -button, and immediately afterwards hold the  button pressed in until the “Software Update Menu” appears.
- Use the  button to move the arrow downwards on the screen until the menu point “Code” is selected.
- You will now see the message “starting SCL”, followed by “- - - -” (or an already activated option; the latter can be overwritten)
- Activate the input process by pressing the  button.
- Enter the code using the  to  buttons on the remote control handset.
- To accept the code you have entered, press the  button when you have finished the data entry process.
- The screen now displays “starting SCL”.
- When the code has been verified, you will see a message such as “GAPL ok” for the release of gapless music playback.

* This function may require a software update



You can obtain the code required for the release process by completing an on-line form, which you will find on the **T+A** website (www.ta-hifi.com) in the Support area under Hardware / Software. You can also contact us by telephone on [0049] 5221-76760, or by post.

Trouble shooting

Many problems have a simple cause and a correspondingly simple solution. The following section describes a few difficulties you may encounter, and the measures you need to take to cure them. If you find it impossible to solve a problem with the help of these notes please disconnect the unit from the mains and ask your authorised **T+A** specialist dealer for advice.

General:

Machine does not switch on (the screen remains dark).

Cause 1:
Mains lead not plugged in correctly.

Remedy:
Check connection, push connector in firmly.

Cause 2:
Mains fuse burned out.

Remedy:
Have the mains fuse replaced by an authorised specialist workshop. The rating of the replacement fuse must agree with the specification printed on the unit.

Machine responds correctly to manual operation of the buttons, but can not be controlled by IR remote control.

Cause 1:
Incorrectly inserted batteries or flat batteries in the remote control handset.

Remedy:
Re-install batteries correctly or fit new ones.

Cause 2:
The remote control transmitter has no direct line-of-sight with the unit.

Remedy:
Make sure that the remote control transmitter has direct line-of-sight contact with the receiver - note that glass doors can interrupt the connection.

Maximum range between transmitter and receiver: approx. 8 metres.

Be sure to position the receiver where it is not subjected to direct sunlight or very bright artificial light. Fluorescent tubes and energy-saving lamps are powerful sources of interference.

Disc drawer does not open.

Cause:
Mechanical blockage, jammed disc, faulty disc mechanism.

Remedy:
Open the disc drawer manually.

First switch the machine off (disconnect the mains plug). You will find an opening in the bottom through which you can disengage the disc drawer by pushing the white disengagement slider fully to the right using a suitable screwdriver. This will cause the drawer to open by a few millimetres, and you can then extend it fully by hand.

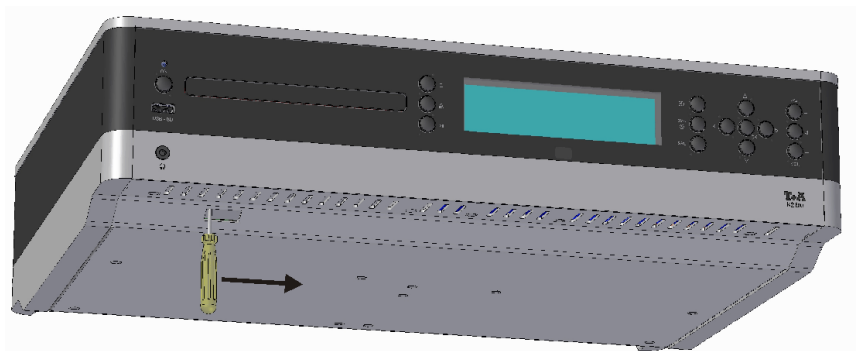

Sound:

The K2 Blu has not detected the Centre loudspeaker or the loudspeakers connected to output B. The associated setup options in the loudspeaker configuration menu and / or the tone control menu are not displayed.

Cause 1:

Loudspeaker cables not connected correctly.

Remedy:

Please check the loudspeaker leads for possible damage. Inspect the cable terminals on the **K2 Blu** and the loudspeaker cabinets, and check that they are making proper contact.

Cause 2:

The loudspeakers connected to the system are fitted with a capacitor in their cross-over input (known as "high-pass filtered" loudspeakers).

Remedy:

A resistor (470 Ohm / 5 W) can be wired in parallel with the loudspeaker; this will enable the K2 Blu to detect such speakers.

If you have queries about this, please contact your local specialist dealer, or refer to the **T+A** Service on the e-mail address 'e-service@taelektroakustik.de'.

Loudspeaker group B cannot be switched on and off using the remote control handset in the main listening room.

Cause 1:

The "Two-room" mode of operation is set to "ON" in the System Configuration - Loudspeaker settings.

Remedy:

In two-room mode, loudspeaker output B can only be controlled using the remote control receiver in the adjacent room. Use the appropriate remote control handset to control loudspeaker group B, or set two-room mode to "OFF".

Cause 2:

The loudspeakers connected to the system are fitted with a capacitor in their cross-over input (known as "high-pass filtered" loudspeakers).

Remedy:

A resistor (470 Ohm / 5 W) can be wired in parallel with the loudspeaker; this will enable the **K2 Blu** to detect such speakers.

If you have queries about this, please contact your local specialist dealer, or refer to the **T+A** Service on the e-mail address 'e-service@ta-hifi.com'.

Very weak bass response**Cause 1:**

The loudspeakers are connected out of phase.

Remedy:

Check that the positive terminal of each loudspeaker is connected to the appropriate positive loudspeaker terminal on the **K2 Blu**.

There are also Test-CDs which provide a simple means of determining correct loudspeaker phase. Please ask your local specialist dealer about this.

Cause 2:

You have set a cross-over frequency ((40, 60, 100 or 150Hz) for the L / R primary loudspeakers (and perhaps also for the Centre speaker) in the System settings / Loudspeaker configuration sub-menu, even though no sub-woofer is present in the system.

Remedy:

Either connect a sub-woofer to the system, or select the "Full-range" setting in the Loudspeaker configuration menu for the L / R main loudspeakers (and also for the Centre, if present). If you are using small loudspeakers, select the "Extended" setting.

Cause 3:

In the Systems settings - Loudspeaker configuration sub-menu you have selected one of the settings "in the corner" or "close to wall", although the speakers are free-standing.

Remedy:

Select the loudspeaker position "Free" in the Loudspeaker configuration menu.

Cause 4:

Unfavourable loudspeaker position, or loudspeakers too small for the size of room.

Remedy:

Alter the position of the speakers in order to achieve a more effective radiation pattern.

Try out the "Extended" setting in the System settings menu - Loudspeaker configuration sub-menu for the L / R main loudspeakers, and perhaps also for the Centre speaker, in order to expand the bass response.

Picture:

No picture from the Blu-ray player.

Cause 1:
HDMI lead not connected, or defective.

Remedy:
Connect the HDMI lead properly; have the lead checked by an expert.

Cause 2:
Video monitor not set to the correct picture input, or an incorrect video norm selected for the input.

Remedy:
Select the picture input (AV input) on the video monitor to which your **K2 Blu** is connected.

Cause 3:
One of the disc mechanism's picture settings (e.g. Resolution in the 'Display' menu) is set to 'Auto'. Many TV sets prefer a fixed setting.

Remedy:
If possible, select fixed settings in the 'Display' menu. You may need to read the operating instructions supplied with your television in order to establish the correct values.

No picture from the iPod.

Cause 1:
Video output switched off at the iPod.

Remedy:
Switch on video output on your iPod.

Cause 2:
A standard analogue video lead (CVBS) is not connected between the **K2 Blu** and the video monitor.

Remedy:
The iPod only generates video signals in standard video form (CVBS). If you use the digital HDMI output for DVD /Blu-ray playback, an FBAS video lead must be connected between the **K2 Blu** and the video monitor in addition to the HDMI lead.

Switch your iPod's video output on, and select the video input on your monitor to which the CVBS output of the **K2 Blu** is connected.

Cause 3:
Your iPod does not support video output.

Remedy:
Ensure that you are using a model of iPod which supports video output.

Streaming Client

The streaming client can not connect to a network.

On the display the indication 'SCL Connecting...' is displayed.

Cause 1 (cable LAN):

Network cable not properly connected

Remedy:

Connect network cable, check connection to router

Cause 2 (wireless LAN):

WLAN antenna not connected or placed in a location with bad reception quality

Remedy:

Connect WLAN antenna properly and find a location with good reception quality.

Set the transmission power output of your WLAN router to maximum.

Try to establish a network connection first in a location close to the WLAN router. If this succeeded try to connect to WLAN from a more remote location. Experiment with antenna position and try to find a location with better reception quality.

Cause 3 (wireless LAN):

WLAN reception quality bad (low field strength). Possibly too much attenuated by walls/ceilings on the transmission path.

Remedy:

Optimize location of receiver and transmitter antennas.

Alternative:

If transmission problems persist a so called 'Power Line' network might be good alternative to establish a good and stable network connection.

The best, safest and most secure network however will always be a cable LAN network.

Cause 4:

Network parameters not properly configured.

Remedy:

Configure the network parameters correctly (see chapter 'Network configuration').

Cause 5 (operation without network connection):

For proper operation the **K2 Blu** needs at least one properly connected network device. This can be a LAN or WLAN network or a USB storage device.

Remedy:

If the **K2 Blu** shall be operated without network (LAN / WLAN) please connect at least a USB stick.

The message 'Track not found' is displayed

Cause:

The music file on the storage device or on the music server was deleted or the internet radio station is not available at the moment.

Remedy:

Choose another music title or radio station. If the station or title is not available any more it should be deleted from the Favourites List (if stored there).

The message 'Format Error' is displayed

Cause:

The title is stored / the radio station is transmitting in a format that cannot be decoded by the **K2 Blu**.

Remedy:

Choose another title or station.

The message 'network problems – restarting' is displayed

Cause:

Network problems in your home network or on the internet occurred; the connection was interrupted.

Remedy:

When encountering a network problem or interruption the **K2 Blu** will re-start the network communication. After re-start please choose a music title or internet radio station and start playback.

Transmission interruptions occur when listening to internet radio stations.	<p>Cause 1: The capacity of the internet radio station's server is at its limit.</p> <p>Remedy: Choose a different station.</p>
	<p>Cause 2: Network problems occurred.</p> <p>Remedy: Check your network (see above).</p>
Some internet radio stations cannot be received	<p>Cause: The internet radio station has been switched off, it transmits only at certain hours of the day or it has changed its internet address.</p> <p>Remedy: Try to get information from the website of the station regarding transmission hours and internet address (URL). Try to establish a connection to the station at a later time.</p>
Bad sound quality at certain internet radio stations	<p>Cause: The station transmits with a low audio bandwidth (low bitrate).</p> <p>Remedy: Use stations transmitting at least at 128 kBit/s. This is the lowest recommended bitrate for adequate sound quality. For good sound quality we recommend high bitrates like 320 kBit/s</p>
USB Storage device is not recognised	<p>Cause 1: The storage device (especially USB hard discs without separate power supply) draws more electrical current from the USB interface than is permitted by the USB standard.</p>
or	
Interruptions and / or jerky reproduction of audio or film material	<p>Remedy: Only use USB storage devices that conform to the USB standard or use storage devices with own power supplies.</p>
	<p>Cause 2: The storage device is not formatted with an appropriate file system.</p>
	<p>Remedy: The K2 Blu accepts storage devices with FAT16 or FAT32 file systems.</p>
	<p>Note: For big music archives we recommend to use a NAS (network attached storage) device with an UPnP-AV server to which the K2 Blu will connect via your home network.</p>
	<p>Cause 3: The data transfer rate of the memory unit is too low, or the memory unit is not compatible with the K2's USB port.</p>
	<p>Remedy: It is not possible to guarantee general compatibility with all devices on the market due to the wide variety of USB memory media available. If you encounter a persistent problem, we suggest that you try a different type of USB memory unit.</p>
	<p>Cause 4: The USB memory unit is connected to the USB socket using a lead, rather than directly.</p>
	<p>Remedy: Many USB extension leads are not suitable for the high data transfer rates which occur during the Streaming process. Use only high-quality certified cables, and ensure that the wire length is as short as possible (<50cm).</p>

Bluetooth

The mobile device cannot make a connection with the K2 Blu.

Cause 1:

The mobile device does not support the A2DP Bluetooth audio transfer protocol.

Remedy:

Use a mobile device which supports the A2DP protocol..

Cause 2:

A mobile device is already connected to the K2 Blu.

Remedy:

You must disconnect the existing connection before the new device can be registered.

Dropouts occur during playback.

Cause 1:

The distance to the K2 Blu is too great (>6 metres), or there are obstacles between the K2 Blu and the mobile device which affect reception.

Remedy:

Reduce the distance to the K2 Blu, and avoid obstacles - such as persons - between the devices.

Cause 2:

The radio connection is suffering interference from other radio networks (e.g. WLAN, baby intercom, etc.) which may already be in use.

Remedy:

If possible, switch to the USB input or the Streaming Client.

NETWORK TERMINOLOGY

General information

The Switch ensures that the individual components within a network are connected correctly. This is only possible if it can identify each device within the network unambiguously; this is the reason why every component is assigned a form of "house number" (IP address). The IP address consists of four blocks of digits with numbers in the range 0 to 255, separated by dots (e.g. 192.168.1.1).

Each of the individual number blocks may contain values between 1 and 254 (the values 0 and 255 are reserved for certain special functions, and should therefore not be used). However, if the network is to operate reliably, the network owner should only select addresses designed for home network use - i.e.: the first two number blocks should always be 192.168.xxx.xxx; the third block can be selected without restriction within the above limits (but should be the same for all devices on the network), and the fourth block must distinguish each device uniquely (e.g.: **K2 Blu** 192.168.001.001, **NAS**: 192.168.001.002, **PC**: 192.168.001.003, ...).

If this local network is to include Internet music sources (Internet radio) as well as physical devices, then the **T+A K2 Blu** must have access to the Internet. This facility is provided by a device such as a router with connection to the DSL network. This router is also a constituent part of the network, and is assigned its own IP address. The **T+A K2 Blu** must also be informed of the address of the router (Gateway) to enable it to gain access to the outside world.



Please ensure that the first three blocks of the Device IP, Gateway IP and DNS 1 share the same address space (e.g. 192.168.0.xxx). The fourth block assigns a unique address (house number) to the components in the local network. This number must not be present more than once in the local network.
The Device IP mask should always be assigned the address 255.255.255.0.

DNS

The Domain Name System (DNS) is one of the most important services on the Internet. Its primary task is to convert "Internet addresses", such as www.taelektroakustik.de, into the associated IP address. In most home networks the router carries out the DNS function.

If you decide to configure your network manually (without DHCP), then simply enter the address of your router as the DNS address when configuring the network.

Ethernet-LAN

Wired network. Interference-free network technology, with the drawback of having to deploy a network cable.

Gateway

The computer or router in your network which is responsible for managing data traffic between your home network and the outside world (i.e. the Internet).

Client

Network device which obtains data from the network, decodes it and converts it into, for example, analogue music signals which can then be reproduced via an amplifier and loudspeakers. Streaming Clients also contain functions for displaying media content, and for navigating on the Internet or servers.

DHCP

DHCP is an abbreviation of **D**ynamic **H**ost **C**onfiguration **P**rotocol. The primary purpose of DHCP is to enable Clients to obtain your network configuration automatically from a server or router.

IP-Adresse

Network address. Each device in the network requires an IP address at which it can be accessed, and by which it is unambiguously identifiable. No individual network address may be present more than once. This is important if you are entering network addresses manually. If the addresses in your network are assigned by DHCP, you do not need to worry about IP addresses at all, as the DHCP server manages the addresses automatically without your intervention.

NAS (Network Attached Storage)	Network storage facility. This is generally a very large-capacity (> 200 GB) storage device to which other devices have access. If the NAS server includes a UPnP-AV server service, then the K2 Blu has access to media files stored on the NAS, and can play them back.
Powerline-LAN	In a Power-Line LAN data is transferred via the existing mains power cabling. Devices known as "Power-Line modems" are required at the transmitting and receiving end. In most cases Power-Line offers relatively problem-free data transfer with adequate data rates for audio streaming. We recommend Power-Line modems with bit rates of 85 or 200 Mbit/s.
Proxy server	A Proxy or Proxy server is a computer in the network which is capable of carrying out data transfers faster and more efficiently, and can increase security through the use of access control mechanisms. Most home networks do not include a proxy server. In this case there is no need to enter a Proxy address when configuring the K2 Blu network.
Router	Central network device which creates and manages the connections between the network devices. In most networks the router also assumes the function of Gateway to the outside world.
Server	Network device which provides data and services for other devices in the network. For example, a UPnP-AV server typically stores audio / video data, and makes it available to other devices (the Streaming Clients). Many UPnP-AV servers also offer functions such as cataloguing, and easy identification of media content using criteria such as artiste, album name, genre, etc.
UPnP-AV	Network protocol that makes media files available on the home network. On PCs and NAS storage devices a UPnP-AV server software must be installed to enable the K2 Blu to access media files stored on these devices. Examples for UPnP-AV server software compatible with the K2 Blu : <u>Windows:</u> - Twonky Media Server http://www.twonkyvision.de/ - Windows Media Player 11 http://www.microsoft.com/windows/windowsmedia/de/default.aspx <u>Linux:</u> - Mediatomb http://mediatomb.cc/ - GmediaServer http://www.gnu.org/software/gmediaserver/
WLAN (also W-LAN, Wireless LAN)	Radio network. The network is connected by means of radio waves operating in the 2.4 GHz frequency band. Radio networks are easy to install as no cables have to be deployed, but they are often problematic and unreliable - especially when the transmission distances are substantial. Power-Line networks, which can also be installed without separate cabling, are a better choice in many situations. In every case the deployment of a network cable is the most reliable and problem-free technology for data transfer.
Compatible hardware and UPnP servers	The market offers a vast number of routers, NAS devices and USB hard discs made by a huge variety of manufacturers. T+A devices are generally compatible with other makes of machine which bear the UPnP label. A list of units which T+A has checked for compatibility can be found on the Internet under http://www.taelektroakustik.de/hardware/comp_lan_hw.pdf .

Notes on Energy Saving

The **K2 Blu** fulfils the requirements of the latest directives designed to economise on the use of energy (EuP directive). The modern construction of its mains PSU and the highly efficient design of the **T+A** switch-mode output stage play an important role in this.

The internal micro-processor constantly ensures that sub-assemblies which are not required for the current task are switched off automatically.

In stand-by mode the current drain depends on the functions of the **K2 Blu** which are still active. Please refer to the table below for more details.

	Energy-saver enabled (ECO standby)	Energy saver disabled (Comfort standby)
Screen brightness	Screen off	Screen off Screen brightness 1 ... 4
Functions available in stand-by mode	* Alarm timer without display * Can be switched on using remote control (except FD 100)	* Alarm timer * Can be switched on by remote control including the FD 100 * Clock display * Automatic clock setting (VHF-RDS)
Automatic power-down function.	enabled	disabled
Stand-by current drain	0,5 W	2 W 5 W



In accordance with EU regulations designed to limit stand-by consumption, the default factory setting for the **K2 Blu** is the energy-saver mode enabled. If you wish to use the additional functions of the Comfort stand-by you must switch the energy-saver off in the menu System Configuration / Energy saver.

Anhang Appendix

Anhang / Appendix A

Anschluss-Schema / Wiring diagram

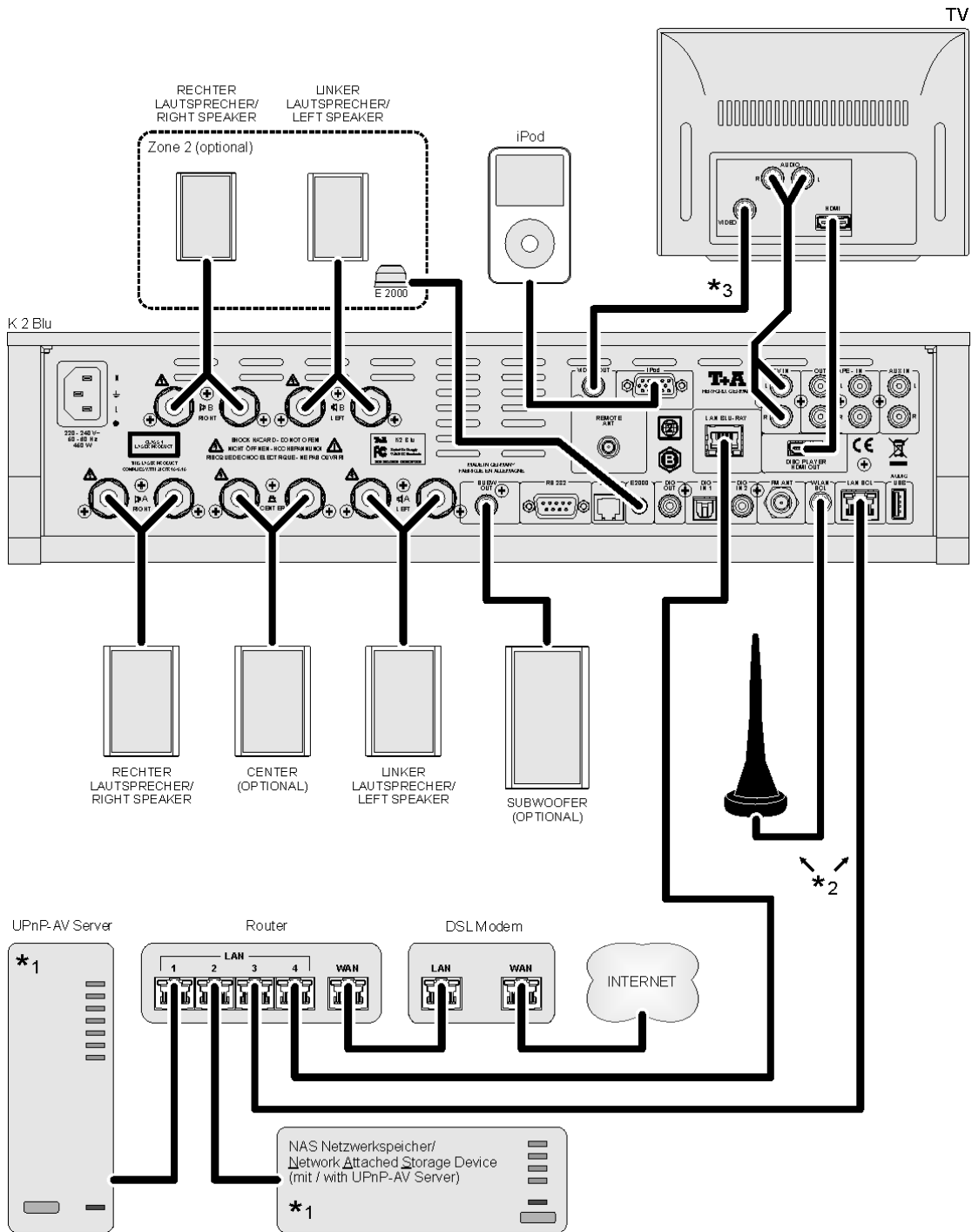

Attention!

A properly set up home network with router must be installed and in operation to use the **K 2 Blu**.

For the use of internet radio a DSL access to the internet is needed.

For questions regarding setting up your network and internet connection please ask your system administrator or any network specialist.

*1 Music Server with UPnP-AV server software installed

*2 Connection either via Cable-LAN or Wireless-LAN

*3 If you wish to access iPod video, you must complete a standard video connection in addition to the HDMI connection, as iPods do not support digital HDMI picture output.



The 'Video Out' (CVBS) output can only be used for video playback from a compatible iPod.

Anschluss-Schema / Wiring diagram

Externe Quellen / External sources

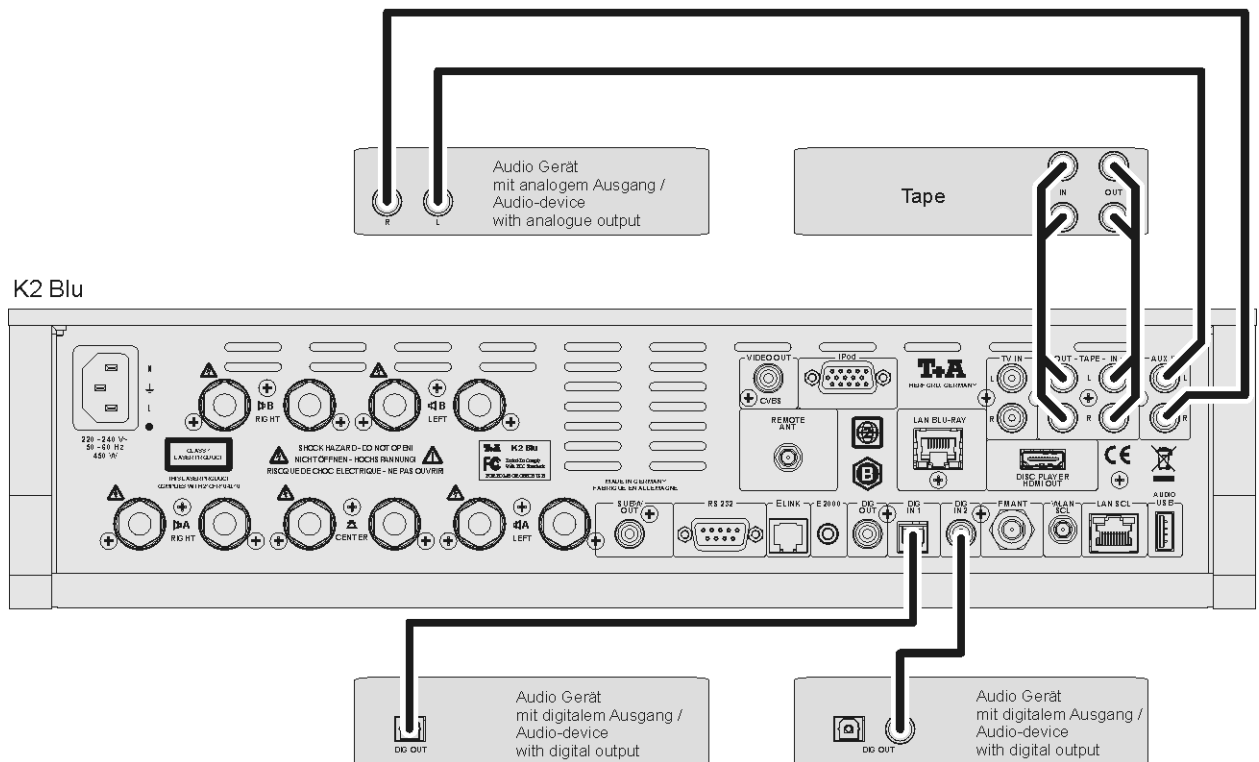

Anschluss-Schema / Wiring diagram

Bi - Amping

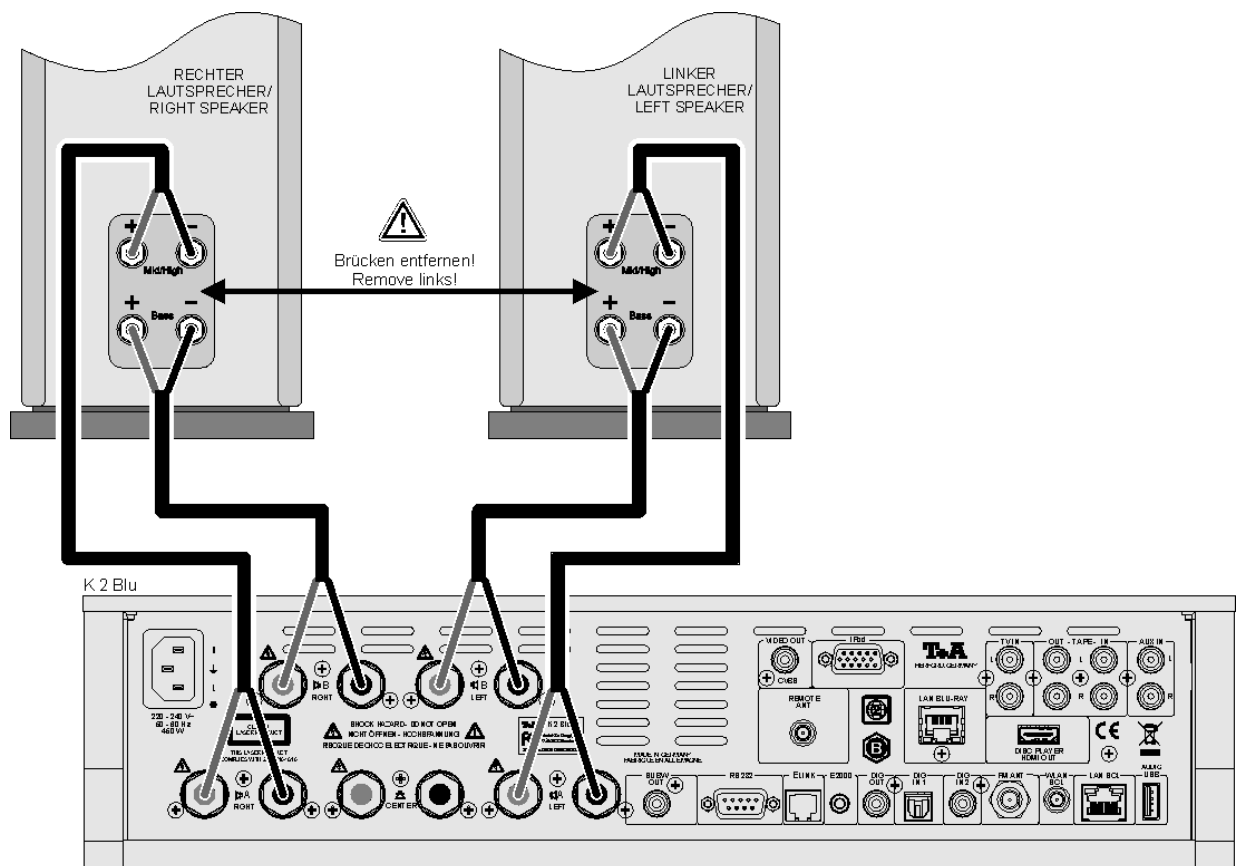

Anhang / Appendix B

Technische Daten / Specification

Verstärkerteil / Amplifier Section		
Externe Eingänge / External inputs		Aux IN, TV IN (mit Auto On / with auto power on), Tape IN - 2 V / 20 kΩ iPod (mit Steuerung / with control)
Kopfhörerausgang / Headphone output		für dynamische Kopfhörer > 50 Ω for dynamic headphones > 50 Ω
Aufnahmeausgänge / Recording outputs (TAPE OUT)		1 V, 150 Ohm
Nennleistung pro Kanal (Stereo) / RMS power output per channel	8 Ω / 4 Ω	95 W / 150 W
Impulsleistung / Peak power output	8 Ω / 4 Ω	130 W / 230 W
Klirrfaktor / T.H.D.		< 0,005 %
Intermodulation / I.M.D.		< 0,005 %
Kanaltrennung / Channel separation		> 65 dB
Frequenzgang / Frequency response		1 Hz – 60 kHz
Betriebsarten / Operating Modes		
Lautsprechergruppe A / Speaker group A	Stereo (2.0 + 2.1), 3-Kanal (3.0 + 3.1), Virtual Surround	Stereo (2.0 + 2.1), 3-Channel (3.0 + 3.1), Virtual Surround
Lautsprechergruppe B / Speaker group B	Stereo (2.0)	Stereo (2.0)
Bassmanagement, Übergangsfrequenzen / Bass management / x-over frequencies	Vollbereich, Erweitert, 40, 60, 100, 150 Hz	Full range, Extended, 40, 60, 100, 150 Hz
Tunerteil / FM Tuner Section		
Empfangsbereich / Tuning range		87,5 – 108 MHz
Empfindlichkeit / Sensitivity		2 μV
Übersteuerungsfestigkeit / max. input level		> 125 dBμV
Stereoübersprechdämpfung / Crosstalk		> 40 dB
RDS-Funktion / RDS functions	Stationsname, Radiotext, Uhrzeit	Station Name, Radiotext, Time
Streaming Client		
Formate / Formats		MP3, WMA, (WMDRM 10), AAC, FLAC, WAV, OGG-Vorbis, AIFF, ALAC
Medienserver / Media server	UPnP AV + DLNA-kompatible Server, vTuner Internet Radio Service	UPnP AV + DLNA comatible servers, vTuner Internet Radio Service
Schnittstellen / Interfaces		USB 2.0, LAN, WLAN
iPod-Schnittstelle / iPod dock		
Wiedergabe von Audio- und Videodateien vom iPod inkl. Steuerung und Fernbedienung des iPod		Playback of audio and video files from the iPod; the iPod can be controlled and remote-controlled
Bluetooth		
A2DP Bluetooth Audioübertragungs- protoll		A2DP Bluetooth audio transfer protocol

Blu-ray - Player		
Laufwerk / Mechanism	3-Laser BluRay Linearlaufwerk auf vibrationsdämpfendem Subchassis	3-laser BluRay linear drive on vibration dampening subchassis
Sonstige Features / other features	BD-Live (mit externem USB Speicherstick) Filmmode 1080p/24 Hz, Erweiterter Farbraum (xvYCC)	BD-Live (with external USB memory stick) Movie mode 1080p/24 Hz, extended colour space (xvYCC)
Tonformate / Audio formats	Stereo DOLBY Pro Logic IIx, DOLBY Digital (AC3), DOLBY EX, DOLBY Digital Plus, DOLBY TrueHD dts, dts-96/24, NEO:6, dts-ES, dts-ES discrete, dts-HighResolution, dts-HD Master Audio	
Videoausgang / Video output	HDMI 1.3 PAL, NTSC Bildformate 16:9, 4:3 Letterbox, Pan Scan	HDMI 1.3 PAL, NTSC Screen formats 16:9, 4:3 Letterbox, Pan Scan
Diskformate / Disc formats	Audio	CDDA (Audio CD), MP3 CD, CD-R, CD/RW, Hybrid SACD CD Layer
	Video	BluRay Disc, DVD, VCD, SVCD
	Foto	JPEG, Picture CD
	Container + other Formats	MKV, MPG, AVI, VOB, MP4, WMV (Playable from an USB Stick connected to the front usb socket and Disc)

RS 232 Steuerschnittstelle / RS 232 control interface	zur Steuerung von entsprechend ausgestatteten Metz oder Loewe TV-Geräten	for controlling suitably equipped Metz or Loewe TV sets
Zubehör / Accessories	Fernbedienung FM 100, IR-Empfänger E 2000, WLAN Antenne (2x), iPod Anschlusskabel	Remote control FM100, IR receiver E2000, WLAN antenna (2x), iPod connecting cable
Optionales Zubehör / Optional accessory	Bidirektionale Funkfernbedienung FD 100	FD 100 radio remote control
Leistungsaufnahme / Pwr consumption	max. 600 W	
	Eco Standby 0,5 W	
	Comfort Standby 2 – 5 W	

Technisch begründete Änderungen vorbehalten. / We reserve the right to alter specifications.

T+A elektroakustik GmbH & Co. KG

Herford

Deutschland * Germany