



CSC-5500N

Multiple Inputs to HDMI/VGA Scaler



Operation Manual

HDMI®
HIGH-DEFINITION MULTIMEDIA INTERFACE

The terms HDMI, HDMI High-Definition Multimedia Interface, and the HDMI Logo are trademarks or registered trademarks of HDMI Licensing Administrator, Inc.

DISCLAIMERS

The information in this manual has been carefully checked and is believed to be accurate. Cypress Technology assumes no responsibility for any infringements of patents or other rights of third parties which may result from its use.

Cypress Technology assumes no responsibility for any inaccuracies that may be contained in this document. Cypress also makes no commitment to update or to keep current the information contained in this document.

Cypress Technology reserves the right to make improvements to this document and/or product at any time and without notice.

COPYRIGHT NOTICE

No part of this document may be reproduced, transmitted, transcribed, stored in a retrieval system, or any of its part translated into any language or computer file, in any form or by any means—electronic, mechanical, magnetic, optical, chemical, manual, or otherwise—without express written permission and consent from Cypress Technology.

© Copyright 2018 by Cypress Technology.

All Rights Reserved.

TRADEMARK ACKNOWLEDGMENTS

All products or service names mentioned in this document are trademarks of the companies with which they are associated.



SAFETY PRECAUTIONS

Please read all instructions before attempting to unpack, install or operate this equipment and before connecting the power supply. Please keep the following in mind as you unpack and install this equipment:

- Always follow basic safety precautions to reduce the risk of fire, electrical shock and injury to persons.
 - To prevent fire or shock hazard, do not expose the unit to rain, moisture or install this product near water.
 - Never spill liquid of any kind on or into this product.
 - Never push an object of any kind into this product through any openings or empty slots in the unit, as you may damage parts inside the unit.
 - Do not attach the power supply cabling to building surfaces.
 - Use only the supplied power supply unit (PSU). Do not use the PSU if it is damaged.
 - Do not allow anything to rest on the power cabling or allow any weight to be placed upon it or any person walk on it.
 - To protect the unit from overheating, do not block any vents or openings in the unit housing that provide ventilation and allow for sufficient space for air to circulate around the unit.
 - Please completely disconnect the power when the unit is not in use to avoid wasting electricity.
-

VERSION HISTORY

REV.	DATE	SUMMARY OF CHANGE
Ver 1.00	2024/01/15	Initial Release





CONTENTS

1. Introduction	1
2. Applications	1
3. Package Contents	1
4. System Requirements	1
5. Features	2
6. Operation Controls and Functions	3
6.1 Front Panel.....	3
6.2 Rear Panel.....	4
6.3 Remote Control	6
6.4 IR Cable Pinouts.....	7
6.5 Serial Pinout and Defaults	7
6.6 OSD Menu.....	8
6.7 WebGUI Control	20
6.7.1 Home Page	23
6.7.2 A/V Management Pages.....	23
6.7.2.1 Routing Page.....	24
6.7.2.2 EDID Management Page	29
6.7.3 System Settings Page	31
6.7.4 User Management Page	33
6.7.5 System Information Page	33
6.8 Telnet Control	34
6.9 Serial and Telnet Commands	34
7. Connection Diagram	62
8. Specifications	63
8.1 Technical Specifications	63
8.2 Video Specifications	64
8.3 Audio Specifications	65
8.3.1 Digital Audio	65
8.3.2 Analog Audio	66
9. Acronyms	68

1. INTRODUCTION

This Multiple Inputs to HDMI/VGA Scaler has Composite Video, Component Video, VGA, and HDMI inputs which can be freely selected for output at a scaled resolution of the user's choosing over the mirrored HDMI and VGA outputs. This unit also includes analog and digital audio outputs to provide additional playback flexibility. It supports HDMI output resolutions up to 1080p/WUXGA with Analog Digital Conversion (ADC), allowing a wide range of A/V signal to be displayed on the connected displays. In addition, the On-Screen Display (OSD), IR remote, RS-232, IP (Telnet/ WebGUI) and on-panel controls make this product very versatile as it can be used in various scenarios.

2. APPLICATIONS

- Analog and digital source integration
- Upscaling standard definition video for high-definition displays
- Conference Centre
- Lecture hall
- Schools and universities

3. PACKAGE CONTENTS

- 1×Multiple Inputs to HDMI/VGA Scaler
- 1×IR Extender Cable
- 1×Remote Control (CR-195)
- 1×5V/2.6A Power Adaptor
- 1×Operation Manual

4. SYSTEM REQUIREMENTS

- HDMI, VGA, component or composite video source equipment such as media players, video game consoles, PCs, or set-top boxes.
- HDMI or VGA receiving equipment such as HDTVs, monitors or audio amplifiers.
- The use of "Premium High Speed HDMI" cables is highly recommended.



5. FEATURES

- HDMI 1.x and DVI 1.0 compatible
- HDCP 1.x compliant
- Multiple video and audio inputs: 3 HDMI, 3 VGA, 1 Component Video, 1 Composite Video, and 8 Stereo audio
- Supports switching and scaling of multiple AV inputs for display over mirrored HDMI and VGA outputs
- Supports input and output resolutions up to 1080p/WUXGA(RB)
- Supports pass-through of LPCM 2.0 audio
- Supports 3D de-interlace, noise reduction, and 3D comb filtering for composite video sources
- Frame rate conversion support
- Supports analog to digital (ADC) and digital to analog (DAC) audio conversion, insertion and extraction
- Quick output resolution switching via hot keys
- Comprehensive EDID and HDCP management
- Remote control provides discrete input source selection and 4 available IR channels
- Controllable via front panel controls with OSD, RS-232, Telnet, WebGUI, and IR remote

6. OPERATION CONTROLS AND FUNCTIONS

6.1 Front Panel

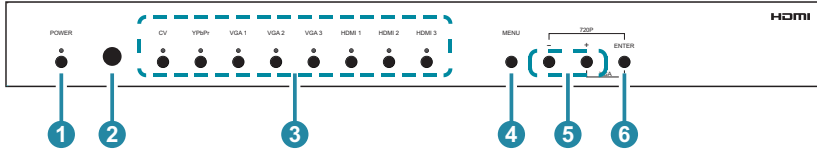

- 1 **POWER & LED:** Press this button to power the unit on or to place it into stand-by mode. The LED will be lit to indicate the unit is on and receiving power. When the unit is in stand-by mode the LED will be off.

Note: The power switch on the back of the unit must also be in the “On” position for the unit to receive power.

- 2 **IR WINDOW:** Accepts IR signals from the included IR remote for control of this unit only.

- 3 **INPUTS & LEDs:** Press any of these buttons to switch immediately to the corresponding input. An LED will illuminate to indicate which source is currently selected.

- 4 **MENU:** Press to enter the OSD menu, or to back out from menu items.

- 5 **PLUS/MINUS(-/+):** Press to navigate or to adjust selections within the OSD menu.

- 6 **ENTER:** Press to confirm a selection within the OSD or to go deeper into a menu item.

Note: Pressing “ENTER” and “+” together will reset the output resolution to XGA (1024×768@60Hz). Pressing “ENTER” and “-” together will reset the output resolution to 720p@60Hz.

6.2 Rear Panel

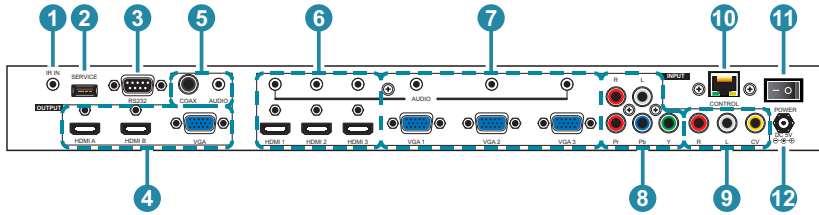

1 IR IN: Connect to the provided IR Extender to extend the IR control range of the unit. Ensure that the remote being used is within direct line-of-sight of the IR Extender.

2 SERVICE: Reserved for manufacturer use only.

3 RS-232: Connect directly to a PC, laptop or other serial control device to send RS-232 commands to control the unit.

4 HDMI OUTPUT: Connect to an HDMI TV, monitor or amplifier for digital video and audio output.

VGA OUTPUT: Connect to a monitor/display for video output.

Note: When the selected HDMI input source signal has HDCP content the VGA/Component output will not display any image.

5 COAX OUTPUT: Connect to an amplifier or active speakers for digital audio output.

Note: When the input audio source signal is in bitstream format and the AUDIO SOURCE setting is set to AUTOMATIC in the OSD menu, the coaxial output will bypass the input audio signal including compatible surround sound formats.

AUDIO OUTPUT: Connect to an amplifier or active speakers for audio output in stereo format.

Note: If the source format is bitstream, this output will be muted automatically.

6 HDMI INPUT 1~3: Connect to HDMI source equipment such as a media players, game consoles or set-top boxes.

AUDIO INPUT 1~3: Connect to the stereo analog output of the device connected to the paired HDMI input port.

Note: If the Audio Source setting is set to "Automatic" and the HDMI input contains audio, it will have priority over the analog input.

7 VGA INPUT 1~3: Connect to VGA source equipment such as a PC or laptop.

AUDIO INPUT 4~6: Connect to the stereo analog output of the device connected to the paired VGA input port.

8 YPbPr & L/R INPUT: Connect to component (YPbPr) video source equipment with stereo audio such as DVD player or set-top box.

9 CV & L/R INPUT: Connect to composite video source equipment with stereo audio such as DVD player or VCR.

10 CONTROL: Connect directly, or through a network switch, to your PC/laptop to control the unit via Telnet/WebGUI.

11 POWER: Flip this switch to provide power to the unit on or to turn it completely off.

Note: This unit's power stand-by functionality will not work if this switch is in the "Off" position.

12 DC 5V: Plug the 5V DC power adapter into the unit and connect it to an AC wall outlet for power.

6.3 Remote Control

The IR remote uses one out of 4 available address channels for control of the unit, allowing up to 4 to be located in the same area while being controlled by different remotes. To configure this, select “REMOTE CONTROL” within the “SYSTEM” section of the OSD’s main menu. Assign a switch combination that matches the setting on the remote that is to be used with the unit.

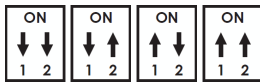

The IR remote’s address can be set using the two DIP switches located on the back of the remote, inside the battery cover. The default factory setting is “1:Off, 2:Off”.

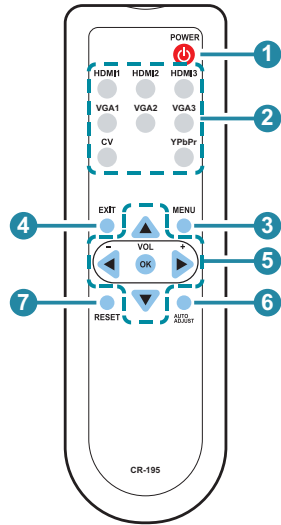

- 1 POWER:** Press this button to power the unit on or to place it into stand-by mode.
- 2 HDMI 1~3, VGA 1~3, CV & YPbPr:** Press any of these buttons to switch immediately to the corresponding input.
- 3 MENU:** Press this button to enter the OSD menu.
- 4 EXIT:** Press this button to exit the menu or the current selection in the OSD menu.
- 5 OK & ▲/▼/◀/▶:** Press OK to confirm the selection or press the UP/DOWN (▲/▼) to navigate the OSD menu. Use the LEFT/RIGHT (◀/▶) to control the volume level.
- 6 AUTO ADJUST:** Press this button to activate the Auto Adjust function for VGA sources.
- 7 RESET:** Press this button to reset the device back to the default settings.

6.4 IR Cable Pinouts

IR Extender
Cable

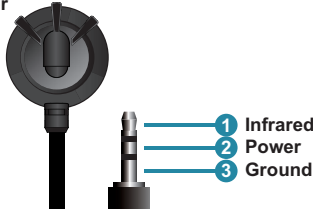

6.5 Serial Pinout and Defaults

Serial Port Default Settings	
Baud Rate	19200
Data Bits	8
Parity Bits	None
Stop Bits	1
Flow Control	None

RS-232

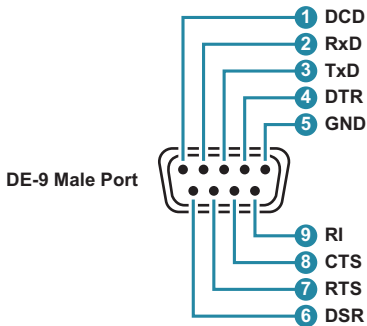

6.6 OSD Menu

All functions of this unit can be controlled by using the OSD (On Screen Display) which is activated by pressing the MENU button on the front of the unit. Use the + (PLUS), - (MINUS), and ENTER buttons to navigate the OSD menu. Press the MENU button to back out from any menu item and then press it again to close the menu.

MAIN MENU
VIDEO
PICTURE
AUDIO
OSD
ETHERNET
EDID
SYSTEM
FACTORY
INFORMATION

The individual functions of the OSD will be introduced in the following section. Items marked in **BOLD** are the factory default settings.

VIDEO		
2ND LEVEL	3RD LEVEL	4TH LEVEL
VIDEO	HDMI 1	
	HDMI 2	
	HDMI 3	
	VGA 1	
	VGA 2	
	VGA 3	
	YPbPr	
	CV	

VIDEO		
2ND LEVEL	3RD LEVEL	4TH LEVEL
OUTPUT	640X480 60	
	800X600 60	
	1024X768 60	
	1280X768 60	
	1360X768 60	
	1366X768 60	
	1280X720 60	
	1280X800 60	
	1280X1024 60	
	1440X900 60	
	1400X1050 60	
	1680X1050 60	
	1600X1200 60	
	1920X1080 60	
	1920X1200 60	
	720X480P 60	
	1280X720P60	
1920X1080P 60		
720X576P 50		
1280X720P 50		
1920X1080P 50		
ASPECT	FULL	
	BEST FIT	
	PAN SCAN	
	LETTER BOX	
	UNDER 2	

VIDEO		
2ND LEVEL	3RD LEVEL	4TH LEVEL
	UNDER 1	
	FOLLOW IN	
	OVERSCAN	
HDMI 1 HDCP MODE	HDCP Support Off	
	Refer to Source	
	REFER TO DISPLAY	
HDMI 2 HDCP MODE	HDCP Support Off	
	Refer to Source	
	REFER TO DISPLAY	
HDMI 3 HDCP MODE	HDCP Support Off	
	Refer to Source	
	REFER TO DISPLAY	
NO SIGNAL COLOR	BLACK	
	WHITE	
	BLUE	
	RED	
	GREEN	
BLANK	ENABLE	
	DISABLE	
FREEZE	ENABLE	
	DISABLE	
AUTO SETUP	AUTO SYNC OFF	OFF
		30S
		60S
		3MIN
		5MIN

VIDEO		
2ND LEVEL	3RD LEVEL	4TH LEVEL
		10MIN
	AUTO ROUTING	OFF
		AUTO SWITCH
		AUTO SCAN
PC SETUP (VGA Inputs Only)	PC AUTO ADJUST	IMCOMPLETE
		COMPLETE
		EXECUTING
	PC H POSITION	0~250
	PC V POSITION	0~250
	PC PHASE	0~255
	PC CLOCK	0~250
	PC RESET	
	PC MODE	1920x1080 60
	2048x1080 60	

- 1) **VIDEO:** Select the input source to use.
- 2) **OUTPUT:** Select the preferred video output resolution.
- 3) **ASPECT:** Selects the aspect ratio to use when outputting the source. "Full" stretches the source to fill the output resolution, regardless of the original aspect ratio, while "Follow Input" will always attempt to retain the original source's correct aspect ratio by adding black bars if necessary.
- 4) **HDMI 1~3 HDCP MODE:** Select the HDCP behavior for each input.
 - **HDCP Support Off:** Completely disables support for HDCP on that input.
 - **Refer to Source:** Makes the input port support the same HDCP version as required by the connected source.
 - **Refer to Display:** Makes the input support the HDCP version of the currently connected displays.
- 5) **NO SIGNAL COLOR:** Change the color to output when no signal is detected.
- 6) **BLANK:** Enable or disable blanking the video output.

- 7) **FREEZE:** Enable or disable freezing the video output.
- 8) **AUTO SETUP:** Provides control over the behavior of the automated video source handling of the unit.
- **AUTO SYNC OFF:** Sets the amount of time to continue outputting sync with the free run color if there is no live source and no operations have been executed on the unit. Setting this to “OFF” forces the unit to always output sync.
 - **AUTO ROUTING:** Select the automatic source routing function to enable or disable. Select “AUTO SWITCH” to automatically switching to any newly detected source. Select “AUTO SCAN” to enable the auto scan on source loss feature. Selecting a specific input will force the search to begin with that input.
- 9) **PC SETUP (VGA inputs only):**
- **PC AUTO ADJUST:** Select to execute the VGA automatic timing adjustment. If the VGA setting has been adjusted manually, the status will show “IMCOMPLETE”. If the automatic adjust is being executing, the display will show “EXECUTING”.
 - **PC H/V Position:** Set the horizontal and vertical position for the current VGA input.
 - **PC PHASE:** Set the PC phase setting for the current VGA input.
 - **PC CLOCK:** Set the PC clock setting for the current VGA input.
 - **PC RESET:** Reset all PC picture settings back to their factory defaults.
 - **PC MODE:** Set the resolution that has detection priority.

PICTURE	
2ND LEVEL	3RD LEVEL
COLOR GAIN R	0~1023 (512)
COLOR GAIN G	0~1023 (512)
COLOR GAIN B	0~1023 (512)
COLOR OFFSET R	0~1023 (512)
COLOR OFFSET G	0~1023 (512)
COLOR OFFSET B	0~1023 (512)

PICTURE	
2ND LEVEL	3RD LEVEL
BRIGHTNESS	0~60 (30)
CONTRAST	0~60 (30)
HUE	0~60 (30)
SATURATION	0~60 (30)
SHARPNESS	0~63 (0)
NR	OFF
	LOW
	MIDDLE
	HIGH
	AUTO
RESET PICTURE	

- 1) **COLOR GAIN R/G/B:** Set the red, green, and blue color gain level of the scaled output.
- 2) **COLOR OFFSET R/G/B:** Set the red, green, and blue color offset level of the scaled output.
- 3) **BRIGHTNESS/CONTRAST:** Set the overall brightness and contrast of the scaled output image
- 4) **HUE:** Set the hue shift of the scaled output image.
- 5) **SATURATION:** Set the color saturation level of the scaled output image.
- 6) **SHARPNESS:** Set the amount of sharpness processing to apply to the scaled output image.
- 7) **NR:** Set the aggressiveness of the digital noise reduction processing when applied to the scaled output image. Selecting “OFF” disables all noise reduction processing.
- 8) **RESET PICTURE:** Reset all picture settings back to their factory defaults.

AUDIO	
2ND LEVEL	3RD LEVEL
AUDIO	AUTOMATIC
	EXTERNAL
AUDIO VOLUME	0~100 (80)
AUDIO MUTE	ENABLE
	MUTE
AUDIO DELAY	None
	40~200ms
RESET AUDIO	

- 1) **AUDIO SOURCE:** Selects the audio source selection method for the HDMI inputs. Selecting “AUTOMATIC” will prioritize HDMI audio, if present, over audio from the associated analog audio inputs. Selecting “EXTERNAL” will force the HDMI inputs to use the associated analog audio inputs.
- 2) **AUDIO VOLUME:** Provides control over the volume level of all audio outputs.
- 3) **AUDIO OUTPUT:** Mute or unmute all audio outputs.
- 4) **AUDIO DELAY:** This control sets the amount of audio delay to use, in milliseconds. Selecting “None” will disable audio delay completely.
- 5) **RESET AUDIO:** Reset all audio settings back to their factory defaults.

OSD	
2ND LEVEL	3RD LEVEL
H POSITION	0~60 (30)
V POSITION	0~60 (30)
MENU TIME OUT	OFF
	5S~60S (5S)
TRANSPARENT	0~50 (0)
INFO DISPLAY	OFF
	ON
	5S
	10S
RESET OSD	

- 1) **H/V Position:** Controls the position of the OSD menu.
- 2) **MENU TIMEOUT:** Set how long to wait before automatically closing the OSD menu if there is no user activity. The timeout can be set to up to 60 seconds, or disabled completely.
- 3) **TRANSPARENT:** Set the transparency level of the OSD menu's background. The available range is from Level 0 (fully opaque) to Level 50 (fully transparent).
- 4) **INFO DISPLAY:** Set the length of time, in seconds, that the informational OSD will be displayed after a signal or source change. Selecting "OFF" will disable the info display. Selecting "ON" will always show the info display.
- 5) **RESET OSD:** Reset all OSD settings back to their factory defaults

ETHERNET			
2ND LEVEL	3RD LEVEL		
IP MODE	STATIC		
	DHCP		
TELNET LOGIN	ON		
	OFF		
SETUP STATIC IP	STATIC IP		0~255 (192)
			0~255 (168)
			0~255 (1)
			0~255 (50)
	MASK		0~255 (255)
			0~255 (255)
		0~255 (255)	
		0~255 (0)	
	GATE	0~255 (192)	
		0~255 (168)	
		0~255 (1)	
		0~255 (254)	
IP	[Current IP address]		
MAC	[Unit's MAC address]		

- 1) **IP MODE:** Set the unit to Static or DHCP mode. When DHCP mode is selected, all IP address information will be assigned automatically by the local DHCP server. When Static is selected, the IP address, netmask and gateway must be set manually and additional menu items become available.
- 2) **TELNET LOGIN:** Enable or disable allowing Telnet logins.

- 3) **SETUP STATIC IP:** The unit’s static IP address, netmask, and gateway address can be set here. Press the “ENTER” button to begin editing the address and use the “+” and “-” buttons to adjust each value. Press the “ENTER” button to store the current number segment and move to the next segment.

Note: The unit’s default static IP address is 192.168.1.50.

- 4) **IP/MAC:** Displays the unit’s MAC address and current IP address.

EDID	
2ND LEVEL	3RD LEVEL
HDMI1 EDID	FHD 2CH
	USER1
	USER2
	USER3
	SINK A EDID
	SINK B EDID
HDMI 2 EDID	[Same options as for HDMI 1]
HDMI 3 EDID	[Same options as for HDMI 1]
HDMI EDID ALL	OFF
	FHD 2CH
	USER1
	USER2
	USER3
	SINK A EDID
SINK B EDID	

- 1) **HDMI 1~3 EDID:** Select the EDID to assign to the specified input.
 2) **HDMI EDID ALL:** Select the EDID to assign to all inputs.

SYSTEM	
2ND LEVEL	3RD LEVEL
REMOTE CONTROL	1: OFF 2:OFF
	1: OFF 2:ON
	1: ON 2:OFF
	1: ON 2:ON

- 1) **REMOTE CONTROL:** Select to change the remote control mode. Assign a switch combination that matches the setting on the remote that is to be used with the unit (See Section 6.3).

Note: The standard remote's default factory setting is "1:Off, 2:Off".

FACTORY
2ND LEVEL
RESET ALL PICTURE
RESET EXCEPT ETHERNET
RESET ALL
UPDATE FROM USB

- 1) **RESET ALL PICTURE:** Reset all picture settings back to their factory defaults.
- 2) **RESET EXCEPT ETHERNET:** Reset all settings except the Ethernet settings back to their factory defaults.
- 3) **RESET ALL:** Reset all of the unit's settings back to their factory defaults. After the reset is complete, the unit will reboot automatically.
- 4) **UPDATE FROM USB:** Provides a way to update the unit's firmware. Insert a USB thumb drive, with a valid firmware file (*.bin format) in the root directory, into the unit's USB service port then select this option. After the update is complete the unit will automatically reboot.

INFORMATION	
2ND LEVEL	3RD LEVEL
VIDEO	[Current Select Input]
INPUT	[Current Input Resolution]
OUTPUT	[Current Output Resolution]
SOURCE HDCP	[Current Input HDCP]
HDMI OUTPUT 1 HDCP	[Current Output HDCP]
HDMI OUTPUT 2 HDCP	
VERSION	[Current Firmware Version]

- 1) **INFORMATION:** Shows information about the unit's current state, input and output resolution, HDCP status, as well as the current firmware version.

6.7 WebGUI Control

• Device Discovery

Please obtain the “Device Discovery” software from your authorized dealer and save it in a directory where you can easily find it.

Connect the unit and your PC/Laptop to the same active network and execute the “Device Discovery” software. Click on “Find Devices on Internet” and a list of devices connected to the local network will show up indicating their current IP address.

Note: This unit defaults to DHCP mode. The current IP address can be verified via the OSD menu or RS-232 if the Device Discovery software is not available

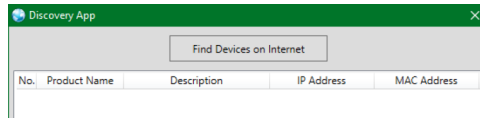

By clicking on one of the listed devices you will be presented with the network details of that particular device.

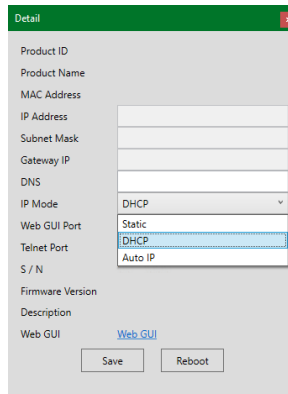

- 1) IP Mode:** If you choose, you can alter the static IP network settings for the device, or switch the unit into DHCP mode to automatically obtain proper network settings from a local DHCP server. To switch to DHCP mode, please select DHCP from the IP mode drop-down, then click “Save” followed by “Reboot”.
- 2) WebGUI Hotkey:** Once you are satisfied with the network settings, you may use them to connect via Telnet or WebGUI. The network information window provides a convenient link to launch the WebGUI directly.

- **WebGUI Overview**

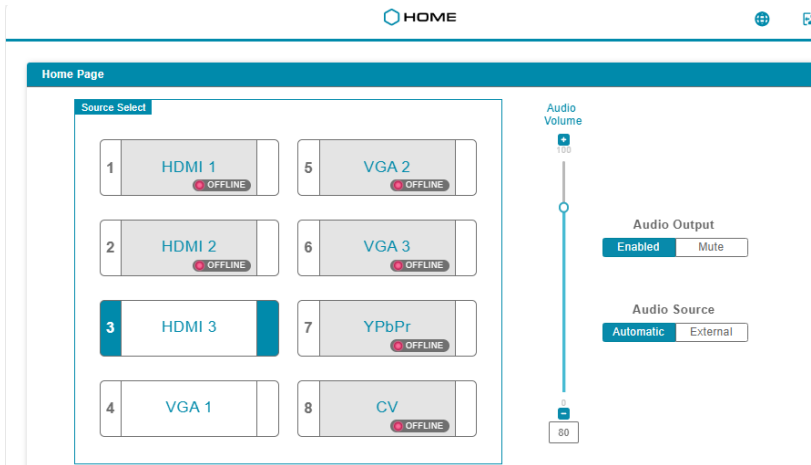

After connecting to the WebGUI's address in a web browser, the home page will appear. This page contains a set of useful functions that can be accessed without the need to log in.

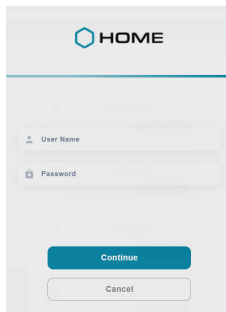

Click the login icon () in the upper right corner to log in, enter the appropriate user name and password then click “Continue” to log in.

Note: The default user name and password is “admin”.



After logging in, the upper right corner will now display 5 navigation icons. Clicking on the “System Settings” icon () will take you to the System Settings page for configuration options including IP configuration, device name, and firmware update functionality. Clicking on the “User Management” icon () will take you to the User Management page, provides access to user management controls for the unit. Clicking on the “Language” icon ()

can change the interface language to user's preference, current only support Traditional Chinses and English. Clicking on the "System Information" icon (🔍) will take you to the System Information page, providing information of technical support for the unit. Clicking on the red "Logout" icon (🚪) will log the currently connected user out of the WebGUI and return to home page.

Clicking on the "Home" icon (🏠) or the unit's logo at the top of the page will return to home page.

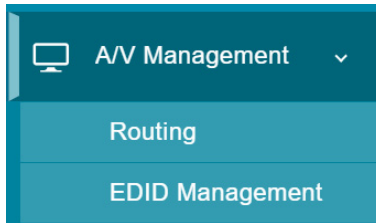

Click on the "Hamburger" icon (☰) in the upper right corner to open up the main page, the left side of the browser will display a compressed version of the above menu tabs where all primary functions of the unit are controllable via the built in WebGUI. The individual functions will be introduced in the following sections.

6.7.1 Home Page

This page provides easy access to A/V routing, volume adjustment, and muting.

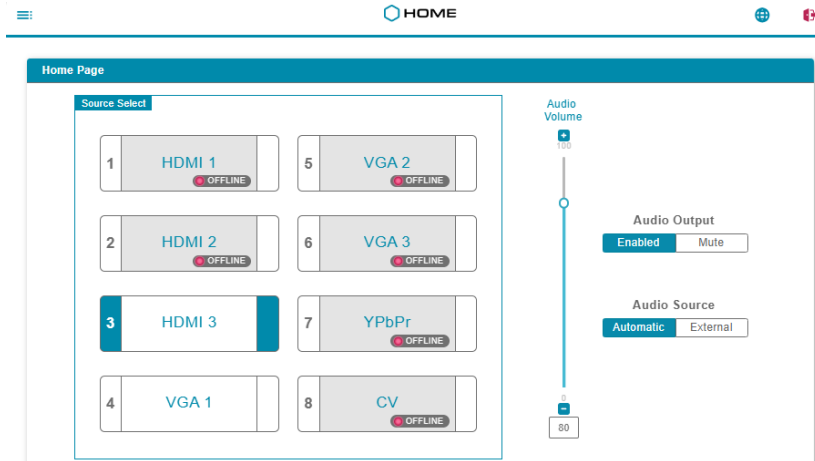

- 1) **Source Select:** These buttons can select the input to route to outputs. Detail about each input's name and current connection status are also displayed here.
- 2) **Audio Volume:** Use the slider to control over the level of Audio Volume.
- 3) **Audio Output:** Mute or unmute all audio outputs.
- 4) **Audio Source:** Select the audio source between Automatic/External.

6.7.2 A/V Management Pages

The A/V Management pages are a collection of two configuration and information pages containing controls for configuring the unit's A/V settings and EDID management.

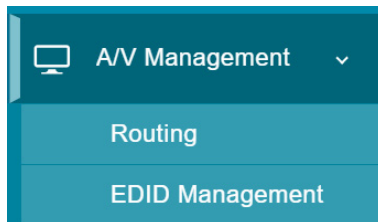

6.7.2.1 Routing Page

This page provides control over A/V routing, volume, HDCP, I/O renaming, video output signal format and behavior, and picture settings. To begin assigning a new video route, please click on the button of the preferred input port. As you select each button they will change their color to blue. The new route will become active immediately after selecting the input port and the routing information displayed on the buttons will change accordingly.

Note: All outputs are linked together, so selecting a source for one will automatically change the source for the others.

The screenshot shows the 'A/V Management - Routing' page. The left sidebar contains 'A/V Management' and 'EDID Management'. The main content area is titled 'A/V Management - Routing' and is divided into 'Video Input' and 'Video Output' sections. The 'Video Input' section has 8 rows: HDMI 1, 2, 3, VGA 1, 2, 3, YPbPr, and CV. HDMI 3 is selected and highlighted in blue. The 'Video Output' section has 3 rows: HDMI A, HDMI B, and VGA. HDMI B is selected and highlighted in blue. Below these sections is an 'Advanced Settings' panel with various controls like Auto Mode, Video Blank, Output Resolution, Freerun Pattern, Audio Source, and Audio Volume.

Video Input		Video Output	
HDMI	1 HDMI 1 Not Connected HDCP: NONE	HDMI	A HDMI A Not Connected HDCP: OFF (No support) Source: [3] HDMI 3
	2 HDMI 2 Not Connected HDCP: NONE		B HDMI B Connected (1920x1080 60) HDCP: 1.4 (Supports 1.4) Source: [3] HDMI 3
	3 HDMI 3 Connected (1920x1080p 60) HDCP: NONE	VGA	C VGA Not Connected Source: [3] HDMI 3
4 VGA 1 Connected			
VGA	5 VGA 2 Not Connected		
	6 VGA 3 Not Connected		
	7 YPbPr Not Connected		
CV	8 CV Not Connected		

Advanced Settings			
Auto Mode	Auto Switch	Auto Sync Off	OFF
Video Blank	Disabled	Video Freeze	Disabled
Output Resolution	1920x1080 60	Aspect Ratio	Full
Freerun Pattern	Black	Information Display	5s
Audio Source	Automatic	Audio Delay	None
Audio Volume	80		

- 1) **Video Input:** These buttons can select the input to route to outputs. Detail about each input's name and current sync/HDCP settings are also displayed here. Clicking on the "Edit" icon (⚙️) opens up the Input Edit window.
- 2) **Video Output:** Buttons for display each output's name and details about the currently routed inputs. Clicking on the "Edit" icon (⚙️) opens up the Output Edit window.
- 3) **Input Edit:** Provides individual control over the name of each input, the behavior of HDCP on HDMI input, and H/V position, clock and phase for VGA input.

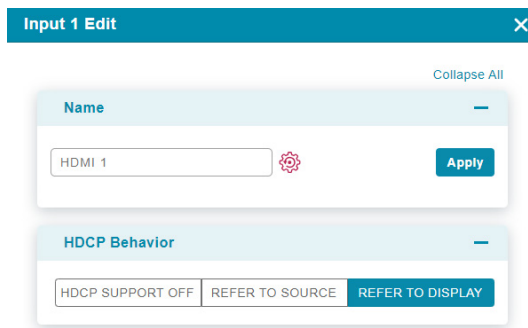

- **Name:** To change the name of an Input, type the new name in the space provided, then click on the "Apply" button. To resume to the stored name before adjusting, click on the revert icon (↶).
- **HDCP Behavior:** Selects the HDCP logic to use with this HDMI input. Changes made to this setting occur immediately.
 - **HDCP Support Off:** Completely disables support for HDCP on this input.
 - **Refer to Source:** Makes the input port support the same HDCP version as required by the connected source.
 - **Refer to Display:** Makes the input support the HDCP version of the currently routed display(s).

■ VGA Configuration:

VGA Configuration —

Auto Adjust

PC H Position	<input type="text" value="119"/>	-	<input type="range" value="119"/>	+
PC V Position	<input type="text" value="34"/>	-	<input type="range" value="34"/>	+
PC Phase	<input type="text" value="8"/>	-	<input type="range" value="8"/>	+
PC Clock	<input type="text" value="126"/>	-	<input type="range" value="126"/>	+

- **Auto Adjust:** Provides a way to manually activate the auto detection of the VGA source's settings.
 - **PC H/V Position:** Set the horizontal and vertical position setting for the current VGA input.
 - **PC Clock:** Set the PC clock setting for the current VGA input.
 - **PC Phase:** Set the PC phase setting for the current VGA input.
- 4) **Output Edit:** Provides control over output naming and video settings.

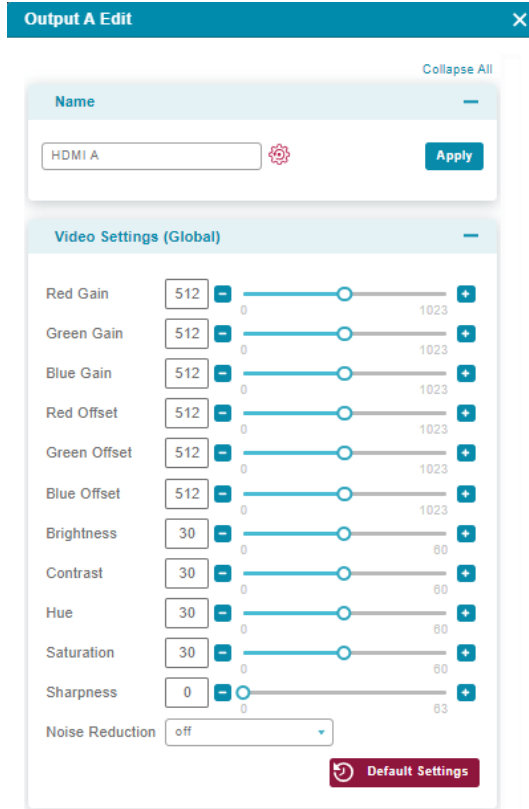

- **Name:** To change the name of an Output, type the new name in the space provided, then click on the “Apply” button. To resume to the stored name before adjusting, click on the revert icon (⚙️).
- **Video Settings (Global):**
 - **R/G/B Gain:** These sliders provide control over the red, green, and blue color gain level of the scaled output.
 - **R/G/B Offset:** These sliders provide control over the red, green, and blue color offset level of the scaled output.
 - **Brightness:** Provides control over the overall brightness of the scaled output image.
 - **Contrast:** Provides control over the overall contrast of the scaled output image.

- **Video Settings (Digital Sources):**
 - **Hue:** Provides control over the hue shift of the scaled output image.
 - **Saturation:** Provides control over the color saturation level of the scaled output image.
 - **Sharpness:** Provides control over the amount of sharpness processing to apply to the scaled output image.
 - **Noise Reduction:** Provides control over the aggressiveness of the digital noise reduction processing when applied to the scaled output image. Selecting “Off” disables all noise reduction processing.
 - **Default Settings:** Reset all picture settings back to their factory defaults.

5) Advanced Settings:

- **Auto Mode:** Select the automatic source routing function to enable or disable. Select “Auto Switch” to automatically switching to any newly detected source. Select “Auto Scan” to enable the auto scan on source loss feature. Selecting a specific input will force the search to begin with that input.
- **Auto Sync Off:** Sets the amount of time to continue outputting sync with the free run color if there is no live source and no operations have been executed on the unit. Setting this to “Off” forces the unit to always output sync.
- **Video Blank:** Enable or disable blanking the video output.
- **Video Freeze:** Enable or disable freezing the video output.
- **Output Resolution:** Select the preferred video output resolution.
- **Aspect Ratio:** Selects the aspect ratio to use when outputting the source. “Full” stretches the source to fill the output resolution, regardless of the original aspect ratio, while “Follow Input” will always attempt to retain the original source’s correct aspect ratio by adding black bars if necessary.
- **Freerun Pattern:** Change the color to output when no signal is detected.
- **Information Display:** Set the length of time, in seconds, that the informational OSD will be displayed after a signal or source change. Selecting “Off” will disable the info display. Selecting “On” will always show the info display.

- **Audio Source:** Selects the audio source selection method for the HDMI inputs. Selecting “Automatic” will prioritize HDMI audio, if present, over audio from the associated analog audio inputs. Selecting “External” will force the HDMI inputs to use the associated analog audio inputs.
- **Audio Delay:** This control sets the amount of audio delay to use, in milliseconds. Selecting “None” will disable audio delay completely.
- **Audio Volume:** Provides control over the volume level of all audio outputs

6.7.2.2 EDID Management Page

This page provides control over the EDID settings of all digital inputs. This unit provides the option of one standard EDID, two sink sourced EDIDs and three user uploaded EDIDs that can be assigned to the input ports. The names of the user uploaded EDIDs can be changed if desired.

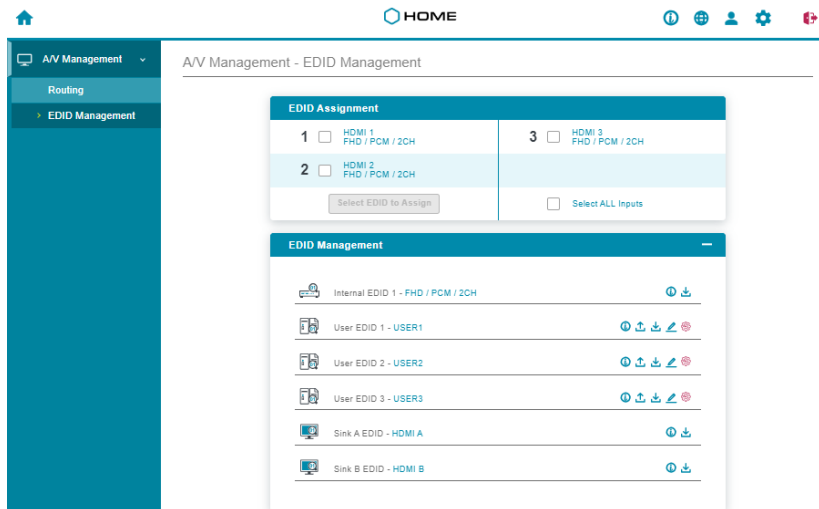

- 1) **EDID Assignment:** Click on the checkbox to select one or more HDMI inputs, press “Select EDID to Assign” button to open the popup window. Select the new EDID source to use then click on the “Apply” button, the change will occur immediately across all selected Inputs.

This unit provides the following default EDID:

Unit's default EDIDs	
FHD/PCM/2CH	1920×1080p@60Hz (4.95Gbps) & 8-bit color, LPCM 2.0

Note: In some rare cases it is possible for custom or external EDIDs to cause compatibility issues with certain sources. If this happens, it is recommended to switch to the default EDID for maximum compatibility.

2) **EDID Management:** This section provide the detailed information for the EDID users applied, including Internal EDID, three User EDIDs, and two Sink EDIDs. Users can view, upload, download, and rename the EDID in this section.

■ **Internal EDID 1:**

- **Information:** Provides view of the detail EDID information.
- **Download:** To save the EDID from a connected display to your local PC, click on the “Download” icon (↓). Depending on your browser settings you will either be asked where to save the downloaded file, or the file will be transferred to the default download location on your PC.

■ **User EDID1~3:**

- **Information:** Provides view of the detail EDID information.
- **Upload:** To upload a User EDID, click on the “Upload” icon (↑). An EDID Upload window will appear, allowing you to locate and upload the preferred EDID file (*.bin format) from a local PC. Once the correct file has been selected, please click the “Upload” button in the window, and the file will be transferred to the unit
- **Download:** To save the EDID from a connected display to your local PC, click on the “Download” icon (↓). Depending on your browser settings you will either be asked where to save the downloaded file, or the file will be transferred to the default download location on your PC.
- **Edit Name:** Click the “Pencil” icon (✎) to open a window that allows changing the name of the User EDID. Click the “Apply” button within the window to confirm the change. To resume to the stored name before adjusting, click on the revert icon (⚙️).
- **Reset:** Click the “revert” icon (⚙️) to reset the EDID to its factory

default content.

- **Sink A/B EDID:**

- **Information:** Provides view of the detail EDID information.
- **Download:** To save the EDID from a connected display to your local PC, click on the “Download” icon (↓). Depending on your browser settings you will either be asked where to save the downloaded file, or the file will be transferred to the default download location on your PC.

6.7.3 System Settings Page

This page provides information on the device's serial number, version, configuration options, and firmware updates. It also allows the user to reset/reboot the system, change the device name, IP mode, and IP configuration. Additionally, users can change the admin login password and the Web Login timeout.

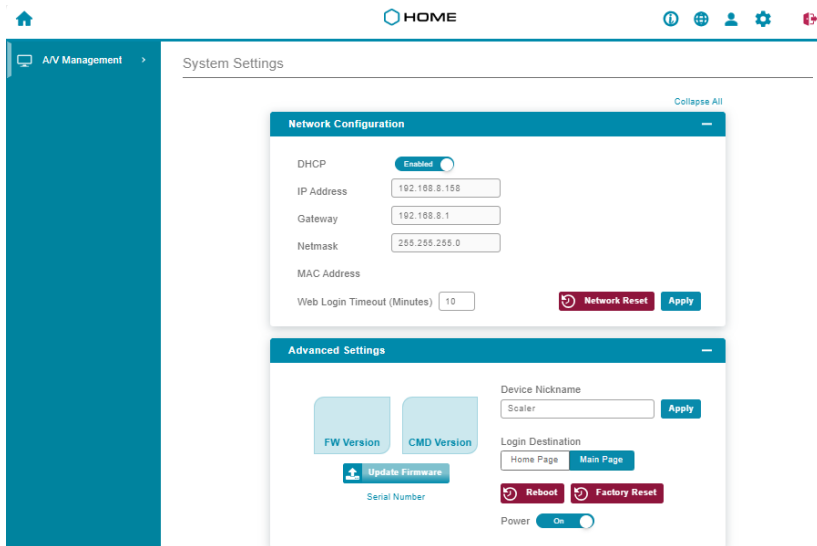

The screenshot shows the 'System Settings' page. The left sidebar has 'A/V Management' selected. The main content area is titled 'System Settings' and has a 'Collapse All' link. It contains two panels:

- Network Configuration:**
 - DHCP: Enabled
 - IP Address:
 - Gateway:
 - Netmask:
 - MAC Address:
 - Web Login Timeout (Minutes):
 - Buttons:
- Advanced Settings:**
 - Buttons:
 -
 - Serial Number:
 - Device Nickname:
 - Login Destination:
 - Buttons:
 - Power: On

1) Network Configuration:

- **IP Configuration:** IP Mode may be switched between Static IP or DHCP. In Static IP Mode the IP, netmask and gateway addresses may be manually set. When in DHCP Mode, the unit will attempt to connect to a local DHCP server and obtain IP, netmask and gateway addresses automatically. Please press “Apply” after making any changes to the IP configuration or mode.

Note: If the IP address is changed then the IP address required for WebGUI/Telnet access will also change accordingly.

- **Web Login Timeout (Minutes):** Set the length of time to wait before logging the user out of the WebGUI due to inactivity. Available range is from 0 to 60 minutes. Setting it to 0 will disable the timeout function.
- **Network Reset:** Reset all Ethernet settings back to their factory defaults.

2) Advanced Settings:

- **Firmware Version:** Displays the unit’s firmware version.
- **CMD Version:** Displays the unit’s command version.
- **Firmware Upgrade:** To update the unit’s firmware, click the “Update Firmware” button to open the file selection window and then select the firmware update file (*.bin format) located on your local PC. After the upgrade is complete, the unit will reboot automatically.
- **Serial Number:** Displays the unit’s serial number.
- **Device Nickname:** To change the name of the unit, type the new name in the space provided, then click on the “Apply” button.
- **Login Destination:** Define the landing page after user login successfully. Selecting "Home Page" will direct the user to the home page, while selecting "Main Page" will take them to Routing Page.
- **System Reboot:** Click this button to reboot the unit.
- **Factory Reset:** Press the “Factory Reset” button to reset the unit to its factory default state. After the reset is complete, the unit will reboot automatically.
- **Power:** Click this button will toggle the unit’s current power state between on and stand-by.

6.7.4 User Management Page

This page provides access to user management controls for the unit, such as changing the admin login password.

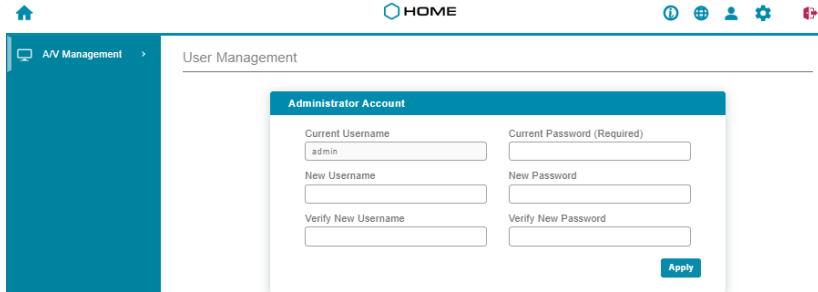

- Administrator Account:** The username and password for the WebGUI can be changed on this page. After entering the old and new login information, press "Apply" to save the changes.

Note: The default user name and password is "admin".

6.7.5 System Information Page

This page provides technical support information, including serial number/version details and contact information for the manufacturer.

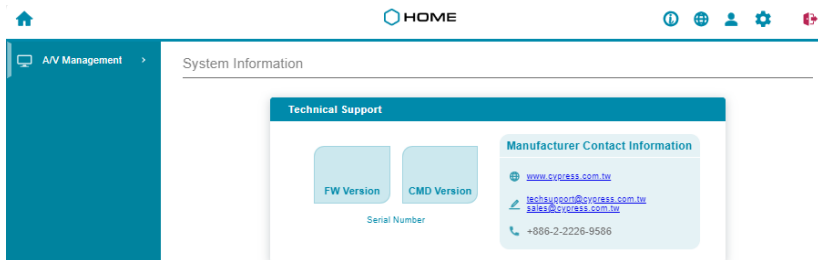

- Information:** Displays the unit's firmware and command version, as well as the unit's serial number.
- Manufacturer Contact Information:**
 - **Website:** Displays the manufacturer's official website link.
 - **E-mail:** Displays the manufacturer's contact email address.
 - **Contact Number:** Displays the manufacturer's contact phone number.

6.8 Telnet Control

Before attempting to use Telnet control, please ensure that both the unit and the PC are connected to the same active networks.

Start your preferred Telnet/Console client, or use the built in client provided by most modern computer operating systems. After starting the client, connect by using the current IP address of the unit and port 23 (if the communication port number used by the unit has not been changed previously). This will connect us to the unit we wish to control and commands may now be entered directly.

Note 1: If the IP address of the unit is changed then the IP address required for Telnet access will also change accordingly.

Note 2: This unit defaults to DHCP mode. The current IP address can be verified via the OSD menu or RS-232 if the Device Discovery software is not available. The default communication port is 23.

6.9 Serial and Telnet Commands

COMMAND
Description and Parameters
help ↵
Show all available commands.
help N1 ↵
Show details about the specified command. N1 = {Command}
? ↵
Show all available commands.
? N1 ↵
Show details about the specified command. N1 = {Command}
get fw ver ↵
Show the unit's current firmware version.

COMMAND	
Description and Parameters	
get command ver ↵	Show the unit's command version.
get mac addr ↵	Show the unit's MAC address.
get model name ↵	Show the unit's model name.
get model type ↵	Show the unit's model type.
set factory default ↵	Reset the unit to its factory defaults.
set factory ipconfig default ↵	Reset the unit's network settings to the factory defaults.
set nickname N1 ↵	Set the name of the unit's nickname. Available values for N1 : N1 = {ASCII string} [Nickname]
get nickname ↵	Show the name of the unit's nickname.
set feedback broadcast N1 ↵	Enable or disable the broadcast of console command feedback. Available values for N1 : ON [Enable] OFF [Disable]
get feedback broadcast ↵	Show the current console command feedback broadcast state.

COMMAND	
Description and Parameters	
set power N1	<p>Set the unit's power state.</p> <p>Available values for N1:</p> <p>ON [Power on]</p> <p>OFF [Standby mode]</p>
get power	<p>Show the unit's current power state.</p>
set system reboot	<p>Reboot the unit.</p>
set system usb fw update	<p>Trigger the unit's firmware update state and load the new firmware file via usb.</p>
set ip mode N1	<p>Set the unit's IP address assignment mode.</p> <p>Available values for N1:</p> <p>STATIC [Static IP mode]</p> <p>DHCP [DHCP mode]</p>
get ip mode	<p>Show the current IP address assignment mode.</p>
get ipaddr	<p>Show the unit's current IP address.</p>
get netmask	<p>Show the unit's current netmask.</p>
get gateway	<p>Show the unit's current gateway address.</p>
set static ipaddr N1	<p>Set the unit's static IP address.</p> <p>N1 = X.X.X.X [X = 0~255, IP address]</p>

COMMAND	
Description and Parameters	
get static ipaddr ↵	Show the unit's current static IP address.
set static netmask N1 ↵	Set the unit's static IP address. N1 = X.X.X.X [X = 0~255, Netmask]
get static netmask ↵	Show the unit's current static netmask.
set static gateway N1 ↵	Set the unit's static IP address. N1 = X.X.X.X [X = 0~255, Gateway address]
get static gateway ↵	Show the unit's current static gateway address.
set webgui username N1 ↵	Set the WebGUI login username. N1 = { ASCII string } [Username]
get webgui username ↵	Show the current WebGUI login username.
set webgui password N1 ↵	Set the WebGUI login password. N1 = {ASCII string} [Password]
get webgui password ↵	Show the current WebGUI login password.
set telnet login N1 ↵	Enable or disable allowing Telnet logins. Available values for N1 : ON [Enabled] OFF [Disabled]

COMMAND																	
Description and Parameters																	
get telnet login ↵	Show the current state of Telnet login allowance.																
set webgui login timeout N1 ↵	Set the WebGUI inactivity timeout value. N1 = 0~60 [Minutes]																
get webgui login timeout ↵	Show the current WebGUI inactivity timeout value.																
get in port number ↵	Show the total number of inputs on the unit.																
get out port number ↵	Show the total number of outputs on the unit.																
set in N1 name N2 ↵	Set the name of the specified input. Available values for N1 : <table border="0"> <tr><td>1</td><td>[HDMI input 1]</td></tr> <tr><td>2</td><td>[HDMI input 2]</td></tr> <tr><td>3</td><td>[HDMI input 3]</td></tr> <tr><td>4</td><td>[VGA input 1]</td></tr> <tr><td>5</td><td>[VGA input 2]</td></tr> <tr><td>6</td><td>[VGA input 3]</td></tr> <tr><td>7</td><td>[YPbPr input]</td></tr> <tr><td>8</td><td>[CV input]</td></tr> </table> N2 = {ASCII string} [Input name]	1	[HDMI input 1]	2	[HDMI input 2]	3	[HDMI input 3]	4	[VGA input 1]	5	[VGA input 2]	6	[VGA input 3]	7	[YPbPr input]	8	[CV input]
1	[HDMI input 1]																
2	[HDMI input 2]																
3	[HDMI input 3]																
4	[VGA input 1]																
5	[VGA input 2]																
6	[VGA input 3]																
7	[YPbPr input]																
8	[CV input]																

COMMAND

Description and Parameters

get in N1 name↵

Show the current name of the specified input.

Available values for **N1**:

1	[HDMI input 1]
2	[HDMI input 2]
3	[HDMI input 3]
4	[VGA input 1]
5	[VGA input 2]
6	[VGA input 3]
7	[YPbPr input]
8	[CV input]

set out N1 name N2↵

Set the name of the specified output.

Available values for **N1**:

A	[HDMI output A]
B	[HDMI output B]
C	[VGA output]
N2 = {ASCII string}	[Output name]

get out N1 name↵

Show the name of the specified output.

Available values for **N1**:

A	[HDMI output A]
B	[HDMI output B]
C	[VGA output]

COMMAND**Description and Parameters****set out A route N1**↵

Route the specified input to all outputs.

Available values for **N1**:

1	[HDMI input 1]
2	[HDMI input 2]
3	[HDMI input 3]
4	[VGA input 1]
5	[VGA input 2]
6	[VGA input 3]
7	[YPbPr input]
8	[CV input]

get out A route↵

Show the current input routed to all outputs.

set out auto mode N1↵

Set the auto switching behavior of the unit.

Available values for **N1**:

0	[Off]
1	[Auto switch]
2	[Auto scan]

get out auto mode↵

Show the current auto switching mode of the unit.

COMMAND

Description and Parameters

get in N1 sync status ←

Show the current sync state of the specified input.

Available values for **N1**:

1	[HDMI input 1]
2	[HDMI input 2]
3	[HDMI input 3]
4	[VGA input 1]
5	[VGA input 2]
6	[VGA input 3]
7	[YPbPr input]
8	[CV input]

Possible response values:

0	[No sync detected]
1	[Sync active]

get out N1 sync status ←

Show the current sync state of the specified output.

Available values for **N1**:

A	[HDMI output A]
B	[HDMI output B]
C	[VGA output]

Possible response values:

0	[No sync detected]
1	[Sync active]

COMMAND**Description and Parameters****get in N1 timing**↵

Show the index number of the current resolution detected on the specified input.

Available values for **N1**:

1	[HDMI input 1]
2	[HDMI input 2]
3	[HDMI input 3]
4	[VGA input 1]
5	[VGA input 2]
6	[VGA input 3]
7	[YPbPr input]
8	[CV input]

Note: Value can only be read if the input is currently selected.

get in N1 uni timing↵

Show the index number of the current resolution detected on the specified input. (Universal index number).

Available values for **N1**:

1	[HDMI input 1]
2	[HDMI input 2]
3	[HDMI input 3]
4	[VGA input 1]
5	[VGA input 2]
6	[VGA input 3]
7	[YPbPr input]
8	[CV input]

Note: Value can only be read if the input is currently selected.

COMMAND

Description and Parameters

get in N1 timing string↵

Show the index number and description of the current resolution detected on the specified input.

Available values for **N1**:

1	[HDMI input 1]
2	[HDMI input 2]
3	[HDMI input 3]
4	[VGA input 1]
5	[VGA input 2]
6	[VGA input 3]
7	[YPbPr input]
8	[CV input]

Note: Value can only be read if the input is currently selected.

get in N1 uni timing string↵

Show the index number and description of the current resolution detected on the specified input. (Universal index number).

Available values for **N1**:

1	[HDMI input 1]
2	[HDMI input 2]
3	[HDMI input 3]
4	[VGA input 1]
5	[VGA input 2]
6	[VGA input 3]
7	[YPbPr input]
8	[CV input]

Note: Value can only be read if the input is currently selected.

COMMAND**Description and Parameters****get out N1 color space↵**

Show the color space format currently used by the specified output.

Available values for **N1**:

A	[HDMI output A]
B	[HDMI output B]
C	[VGA output]

Possible response values:

1	[RGB]
2	[YUV422]
3	[YUV444]

get in N1 type↵

Show the port type of the specified input.

Available values for **N1**:

1	[HDMI input 1]
2	[HDMI input 2]
3	[HDMI input 3]
4	[VGA input 1]
5	[VGA input 2]
6	[VGA input 3]
7	[YPbPr input]
8	[CV input]

get out N1 type↵

Show the port type of the specified output.

Available values for **N1**:

A	[HDMI output A]
B	[HDMI output B]
C	[VGA output]

COMMAND

Description and Parameters

set out A timing N1↵

Set the output resolution to use for all outputs.

Available values for **N1**:

1	[640X480 60]
2	[800X600 60]
3	[1024X768 60]
4	[1280X768 60]
5	[1360X768 60]
6	[1366X768 60]
7	[1280X720 60]
8	[1280X800 60]
9	[1280X1024 60]
10	[1440X900 60]
11	[1400X1050 60]
12	[1680X1050 60]
13	[1600X1200 60]
14	[1920X1080 60]
15	[1920X1200 60]
16	[720X480P 60]
17	[1280X720P 60]
18	[1920X1080P 60]
19	[720X576P 50]
20	[1280X720P 50]
21	[1920X1080P 50]

get out A timing↵

Show the index number of the current resolution used for all outputs.

get out A timing string↵

Show the description string of the current resolution used for all outputs.

get out timing list↵

List all available output resolutions with their local index numbers.

COMMAND	
Description and Parameters	
set out A contrast N1 ↵	
Set the scaled output's contrast level.	
N1 = 0~60	[Contrast level]
get out A contrast ↵	
Show the contrast level when the output is scaled.	
set out A brightness N1 ↵	
Set the scaled output's brightness level.	
N1 = 0~60	[Brightness level]
get out A brightness ↵	
Show the brightness level when the output is scaled.	
set out A saturation N1 ↵	
Set the scaled output's saturation level.	
N1 = 0~60	[Saturation level]
get out A saturation ↵	
Show the saturation level when the output is scaled.	
set out A hue N1 ↵	
Set the scaled output's hue value.	
N1 = 0~60	[Hue value]
get out A hue ↵	
Show the current hue value of the specified output.	
set out A sharpness N1 ↵	
Set the scaled output's sharpness level.	
N1 = 0~63	[Sharpness level]
get out A sharpness ↵	
Show the sharpness level when the output is scaled.	

COMMAND																	
Description and Parameters																	
set out A nr N1	<p>Set the amount of noise reduction to apply when the output is scaled.</p> <p>Available values for N1:</p> <table> <tr> <td>0</td> <td>[Off]</td> </tr> <tr> <td>1</td> <td>[Low]</td> </tr> <tr> <td>2</td> <td>[Middle]</td> </tr> <tr> <td>3</td> <td>[High]</td> </tr> <tr> <td>4</td> <td>[Auto]</td> </tr> </table>	0	[Off]	1	[Low]	2	[Middle]	3	[High]	4	[Auto]						
0	[Off]																
1	[Low]																
2	[Middle]																
3	[High]																
4	[Auto]																
get out A nr	<p>Show the current amount of noise reduction applied when the output is scaled.</p>																
get out nr list	<p>List all available noise reduction processing options.</p>																
set out A aspect ratio N1	<p>Set the aspect ratio of the video shown when the output is scaled.</p> <p>Available values for N1:</p> <table> <tr> <td>1</td> <td>[Overscan]</td> </tr> <tr> <td>2</td> <td>[Full]</td> </tr> <tr> <td>3</td> <td>[Best fit]</td> </tr> <tr> <td>4</td> <td>[Pan & scan]</td> </tr> <tr> <td>5</td> <td>[Letterbox]</td> </tr> <tr> <td>6</td> <td>[Underscan 2]</td> </tr> <tr> <td>7</td> <td>[Underscan 1]</td> </tr> <tr> <td>8</td> <td>[Follow input]</td> </tr> </table>	1	[Overscan]	2	[Full]	3	[Best fit]	4	[Pan & scan]	5	[Letterbox]	6	[Underscan 2]	7	[Underscan 1]	8	[Follow input]
1	[Overscan]																
2	[Full]																
3	[Best fit]																
4	[Pan & scan]																
5	[Letterbox]																
6	[Underscan 2]																
7	[Underscan 1]																
8	[Follow input]																
get out A aspect ratio	<p>Show the currently set aspect ratio for the video shown when the output is scaled.</p>																
get out aspect ratio list	<p>List all available aspect ratio options.</p>																

COMMAND													
Description and Parameters													
set out A auto sync off N1	<p>Enable or disable the Auto Sync Off function and set the timeout length. Available values for N1:</p> <table> <tr> <td>0</td> <td>[Disabled]</td> </tr> <tr> <td>1</td> <td>[30 seconds]</td> </tr> <tr> <td>2</td> <td>[60 seconds]</td> </tr> <tr> <td>3</td> <td>[3 minutes]</td> </tr> <tr> <td>4</td> <td>[5 minutes]</td> </tr> <tr> <td>5</td> <td>[10 minutes]</td> </tr> </table>	0	[Disabled]	1	[30 seconds]	2	[60 seconds]	3	[3 minutes]	4	[5 minutes]	5	[10 minutes]
0	[Disabled]												
1	[30 seconds]												
2	[60 seconds]												
3	[3 minutes]												
4	[5 minutes]												
5	[10 minutes]												
get out A auto sync off	<p>Show the current Auto Sync Off setting.</p>												
set out A r gain N1	<p>Set the scaled output's red gain level. N1 = 0~1023 [Red gain level]</p>												
get out A r gain	<p>Show the scaled output's current red gain level.</p>												
set out A g gain N1	<p>Set the scaled output's green gain level. N1 = 0~1023 [Green gain level]</p>												
get out A g gain	<p>Show the scaled output's current green gain level.</p>												
set out A b gain N1	<p>Set the scaled output's blue gain level. N1 = 0~1023 [Blue gain level]</p>												
get out A b gain	<p>Show the scaled output's current blue gain level.</p>												
set out A r offset N1	<p>Set the scaled output's red offset. N1 = 0~1023 [Red offset]</p>												

COMMAND	
Description and Parameters	
get out A r offset ↵	Show the scaled output's current red offset.
set out A g offset N1 ↵	Set the scaled output's green offset. N1 = 0~1023 [Green offset]
get out A g offset ↵	Show the scaled output's current green offset.
set out A b offset N1 ↵	Set the scaled output's blue offset. N1 = 0~1023 [Blue offset]
get out A b offset ↵	Show the scaled output's current blue offset.
set in N1 phase N2 ↵	Set the PC phase value for the current routed VGA input. Available values for N1: 4 [VGA input 1] 5 [VGA input 2] 6 [VGA input 3] N2 = 0~255 [PC phase]
get in N1 phase ↵	Show the current PC phase value for the current routed VGA input. Available values for N1: 4 [VGA input 1] 5 [VGA input 2] 6 [VGA input 3]

COMMAND	
Description and Parameters	
set in N1 clock N2↵	
Set the PC clock value for the current routed VGA input.	
Available values for N1 :	
4	[VGA input 1]
5	[VGA input 2]
6	[VGA input 3]
N2 = 0~250	[PC clock]
get in N1 clock↵	
Show the current PC clock value for the current routed VGA input.	
Available values for N1 :	
4	[VGA input 1]
5	[VGA input 2]
6	[VGA input 3]
set in N1 hposition N2↵	
Set the PC horizontal position for the current routed VGA input.	
Available values for N1 :	
4	[VGA input 1]
5	[VGA input 2]
6	[VGA input 3]
N2 = 0~250	[Horizontal position]
get in N1 hposition↵	
Show the current PC horizontal position for the current routed VGA input.	
Available values for N1 :	
4	[VGA input 1]
5	[VGA input 2]
6	[VGA input 3]

COMMAND	
Description and Parameters	
set in N1 vposition N2 ↵	
Set the PC vertical position for the current routed VGA input.	
Available values for N1 :	
4	[VGA input 1]
5	[VGA input 2]
6	[VGA input 3]
N2 = 0~250	[Vertical position]
get in N1 vposition ↵	
Show the current PC vertical position for the current routed VGA input.	
Available values for N1 :	
4	[VGA input 1]
5	[VGA input 2]
6	[VGA input 3]
set vga auto adjust mode N1 ↵	
Enable or disable the VGA input auto adjust function.	
Available values for N1 :	
ON	[Enabled]
OFF	[Disabled]
get vga auto adjust mode ↵	
Show the current state of the VGA input auto adjust function.	
set out A freeze N1 ↵	
Enable or disable freezing the video output.	
Available values for N1 :	
ON	[Video output frozen]
OFF	[Video output normal]
get out A freeze ↵	
Show the current video output freeze state.	

COMMAND

Description and Parameters

set out A blank N1↵

Enable or disable blanking the video output

Available values for **N1**:

ON	[Video output blanked]
OFF	[Video output normal]

get out A blank↵

Show the current video output blanking state.

set out A osd timeout N1↵

Set the OSD menu's timeout value.

Available values for **N1**:

0	[Timeout disabled]
1	[5 seconds]
2	[10 seconds]
3	[15 seconds]
4	[20 seconds]
5	[25 seconds]
6	[30 seconds]
7	[35 seconds]
8	[40 seconds]
9	[45 seconds]
10	[50 seconds]
11	[55 seconds]
12	[60 seconds]

get out A osd timeout↵

Show the current OSD menu timeout value.

COMMAND

Description and Parameters

set out A osd info display N1↵

Enable/disable the info OSD, or set it to display briefly.

Available values for **N1**:

0	[Always off]
1	[Always on]
2	[5 seconds]
3	[10 seconds]

get out A osd info display↵

Show the current info OSD state in plain text.

set out A osd vposition N1↵

Set the vertical position of the OSD menu.

N1 = 0~60 [Vertical position]

get out A osd vposition↵

Show the current vertical position of the OSD menu.

set out A osd hposition N1↵

Set the horizontal position of the OSD menu.

N1 = 0~60 [Horizontal position]

get out A osd hposition↵

Show the current vertical position of the OSD menu.

set out A osd transparency level N1↵

Set the transparency level of the OSD menu.

N1 = 0~50 [Transparency level]

get out A osd transparency level↵

Show the current transparency level of the OSD menu.

set audio out A mute N1↵

Enable or disable muting on all audio outputs.

Available values for **N1**:

ON	[Mute]
OFF	[Audio enabled]

COMMAND	
Description and Parameters	
get audio out A mute ↵↵	
	Show the current mute state of all audio outputs.
set audio out A route N1 ↵↵	
	Set the audio source selection behavior of the unit. Available values for N1 :
1	[Automatic]
2	[External]
get audio out A route ↵↵	
	Show the unit's current audio source selection behavior.
set audio out A volume N1 ↵↵	
	Set the volume level of all audio outputs. N1 = 0~100 [Volume level]
get audio out A volume ↵↵	
	Show the current volume level of all audio outputs.
set audio out A volume up ↵↵	
	Increase the volume level of all audio outputs by 1 unit.
set audio out A volume down ↵↵	
	Decrease the volume level of all audio outputs by 1 unit.

COMMAND

Description and Parameters

set audio out A delay N1↵

Set the audio delay value for all audio outputs.

Available values for **N1**:

0	[Delay disabled]
1	[40 millisecond]
2	[50 millisecond]
3	[60 millisecond]
4	[70 millisecond]
5	[80 millisecond]
6	[90 millisecond]
7	[100 millisecond]
8	[110 millisecond]
9	[120 millisecond]
10	[130 millisecond]
11	[140 millisecond]
12	[150 millisecond]
13	[160 millisecond]
14	[170 millisecond]
15	[180 millisecond]
16	[190 millisecond]
17	[200 millisecond]

get audio out A delay↵

Show the current audio delay value for all audio outputs.

set audio out A name N1↵

Set the name of the specified audio output.

Available values for **N1**:

A	[HDMI]
B	[AUDIO]
C	[COAX]
N2 = {ASCII string}	[Audio name]

COMMAND	
Description and Parameters	
get audio out N1 name ↵	
Show the name of the specified audio output.	
Available values for N1 :	
A	[HDMI]
B	[AUDIO]
C	[COAX]
get audio in type list ↵	
List all available audio input sources.	
get audio out type list ↵	
List all available audio output destinations.	
set in N1 edid N2 ↵	
Set the EDID to use on the specified input.	
Available values for N1 :	
1	[HDMI input 1]
2	[HDMI input 2]
3	[HDMI input 3]
Available values for N2 :	
1	[Default FHD 2CH]
2	[User EDID 1]
3	[User EDID 2]
4	[User EDID 3]
5	[HDMI output A]
6	[HDMI output B]
get in N1 edid ↵	
Show the EDID currently being used on the specified input.	
Available values for N1 :	
1	[HDMI input 1]
2	[HDMI input 2]
3	[HDMI input 3]

COMMAND									
Description and Parameters									
get in edid list ↵	List all available EDID selections.								
set edid N1 name N2 ↵	Set the name for the specified EDID. (Only User EDIDs may be renamed) Available values for N1 : <table data-bbox="190 486 744 638"> <tr> <td>1</td> <td>[User EDID 1]</td> </tr> <tr> <td>2</td> <td>[User EDID 2]</td> </tr> <tr> <td>3</td> <td>[User EDID 3]</td> </tr> <tr> <td>N2 = {ASCII string}</td> <td>[User EDID name]</td> </tr> </table>	1	[User EDID 1]	2	[User EDID 2]	3	[User EDID 3]	N2 = {ASCII string}	[User EDID name]
1	[User EDID 1]								
2	[User EDID 2]								
3	[User EDID 3]								
N2 = {ASCII string}	[User EDID name]								
get edid N1 name ↵	Show the name for the specified EDID. N1 = 1~3 [User EDID number]								
set user N1 edid data N2 ↵	Upload a new EDID (in hex format) for use as the specified User EDID. N1 = 1~3 [User EDID number] N2 = {EDID data} [Comma delimited hex pairs]								
get user N1 edid data ↵	Show the current contents of the specified User EDID as hex data. N1 = 1~3 [User EDID number]								
get sink N1 edid data ↵	Show the EDID from the display connected to the specified output as hex data. Available values for N1 : <table data-bbox="190 1212 722 1284"> <tr> <td>A</td> <td>[HDMI output A]</td> </tr> <tr> <td>B</td> <td>[HDMI output B]</td> </tr> </table>	A	[HDMI output A]	B	[HDMI output B]				
A	[HDMI output A]								
B	[HDMI output B]								

COMMAND															
Description and Parameters															
get in N1 edid data ↵	<p>Show the EDID currently used by the specified input as hex data.</p> <p>Available values for N1:</p> <table border="0"> <tr> <td>1</td> <td>[HDMI input 1]</td> </tr> <tr> <td>2</td> <td>[HDMI input 2]</td> </tr> <tr> <td>3</td> <td>[HDMI input 3]</td> </tr> </table>	1	[HDMI input 1]	2	[HDMI input 2]	3	[HDMI input 3]								
1	[HDMI input 1]														
2	[HDMI input 2]														
3	[HDMI input 3]														
get internal N1 edid data ↵	<p>Show the specified Internal EDID as hex data.</p> <p>N1 = 1 [Internal EDID number]</p>														
get all in edid list ↵	<p>List the EDIDs assigned to all inputs.</p>														
set all in edid N1 ↵	<p>Set the EDID to use for all of the available inputs.</p> <p>Available values for N1:</p> <table border="0"> <tr> <td>1</td> <td>[Default FHD 2CH]</td> </tr> <tr> <td>2</td> <td>[User EDID 1]</td> </tr> <tr> <td>3</td> <td>[User EDID 2]</td> </tr> <tr> <td>4</td> <td>[User EDID 3]</td> </tr> <tr> <td>5</td> <td>[HDMI output A]</td> </tr> <tr> <td>6</td> <td>[HDMI output B]</td> </tr> <tr> <td>7</td> <td>[Disable]</td> </tr> </table>	1	[Default FHD 2CH]	2	[User EDID 1]	3	[User EDID 2]	4	[User EDID 3]	5	[HDMI output A]	6	[HDMI output B]	7	[Disable]
1	[Default FHD 2CH]														
2	[User EDID 1]														
3	[User EDID 2]														
4	[User EDID 3]														
5	[HDMI output A]														
6	[HDMI output B]														
7	[Disable]														
get all in edid ↵	<p>Show the current EDID used for all of the available inputs.</p>														
get internal edid number ↵	<p>Show the total number of internal EDIDs in the unit.</p>														
get user edid number ↵	<p>Show the total number of user EDIDs in the unit.</p>														
get sink edid number ↵	<p>Show the total number of sink EDIDs in the unit.</p>														

COMMAND

Description and Parameters

set in N1 hdcp mode N2↵

Set the HDCP behavior of the specified input.

Available values for **N1**:

1	[HDMI input 1]
2	[HDMI input 2]
3	[HDMI input 3]

Available values for **N2**:

0	[HDCP disabled]
1	[Follow source]
2	[Follow display]

get in N1 hdcp mode↵

Show the current HDCP behavior used by the specified input.

Available values for **N1**:

1	[HDMI input 1]
2	[HDMI input 2]
3	[HDMI input 3]

get in N1 hdcp status↵

Show the current HDCP status of the specified input.

Available values for **N1**:

1	[HDMI input 1]
2	[HDMI input 2]
3	[HDMI input 3]

COMMAND

Description and Parameters

get out N1 hdcp status↵

Show the current HDCP status of the specified output.

Available values for **N1**:

A	[HDMI output A]
B	[HDMI output B]

Possible response values:

0	[No HDCP]
1	[HDCP 1.x active]
2	[HDCP 2.2 active]

get out N1 hdcp ability↵

Show the HDCP compliance level of the display device connected to the specified output.

Available values for **N1**:

A	[HDMI output A]
B	[HDMI output B]

Possible response values:

0	[No HDCP support]
1	[HDCP 1.x supported]
2	[HDCP 2.2 supported]

get in N1 hdcp ability↵

Show the HDCP compliance level of the source connected to the specified input.

Available values for **N1**:

1	[HDMI input 1]
2	[HDMI input 2]
3	[HDMI input 3]

Possible response values:

0	[No HDCP support]
1	[HDCP 1.x supported]
2	[HDCP 2.2 supported]

COMMAND	
Description and Parameters	
set freerun A type N1 ↵	
Set the freerun type to use when freerun is active on the unit.	
Available values for N1 :	
1	[Black]
2	[White]
3	[Blue]
4	[Red]
5	[Green]
get freerun A type ↵	
Show the current freerun type used when freerun is active on the unit.	
get freerun list ↵	
List all available freerun types.	

Note: Commands will not be executed unless followed by a carriage return. Commands are not case-sensitive.

7. CONNECTION DIAGRAM

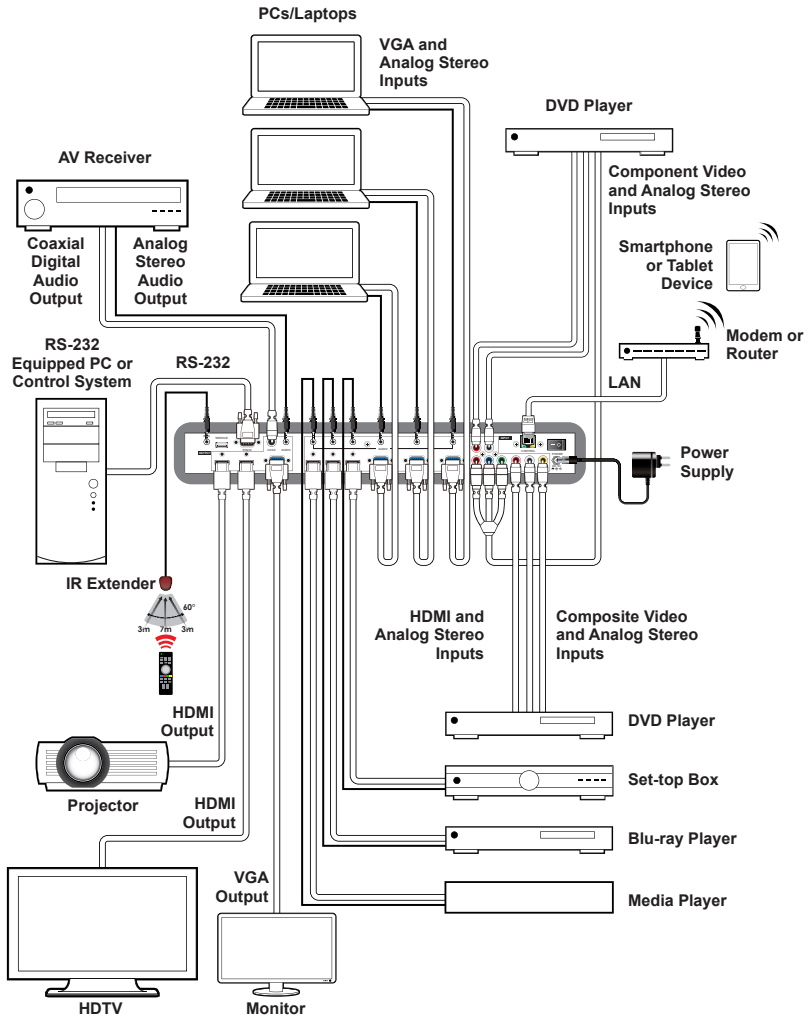

8. SPECIFICATIONS

8.1 Technical Specifications

HDMI Bandwidth	165MHz/4.95Gbps
VGA Bandwidth	165MHz
Input Ports	3×HDMI (Type-A) 3×VGA (HD-15) 1×YPbPr (RCA) 1×CV (RCA) 6×Stereo Audio (3.5mm) 4×Stereo (RCA)
Output Ports	2×HDMI (Type-A) 1×VGA (HD-15) 1× Coaxial (RCA) 1× Stereo Audio (3.5mm)
Control Ports	1×IR Extender (3.5mm) 1×RS-232 (DE-9) 1×IP Control (RJ-45)
Service Port	1×USB (Type-A)
IR Frequency	30 ~ 50kHz (30 ~ 60kHz under ideal conditions)
Baud Rate	19200
Power Supply	5V/3A DC (US/EU standards, CE/FCC/UL certified)
ESD Protection (HBM)	±8kV (Air Discharge) ±4kV (Contact Discharge)
Dimensions (W×H×D)	432mm×174mm×44mm [Case Only] 432mm×183mm×47mm [All Inclusive]
Weight	2,140g
Chassis Material	Metal (Steel)

Chassis Color	Black
Operating Temperature	0°C – 50°C/32°F – 114°F
Storage Temperature	-20°C – 60°C/-4°F – 140°F
Relative Humidity	20 – 90% RH (Non-condensing)
Power Consumption	9W

8.2 Video Specifications

Supported Resolutions (Hz)	Input				Output	
	HDMI	VGA	CV	YPbPr	HDMI	VGA
720×400p@70/85	✓	✓	×	×	×	×
640×480p@60/72/75/85	✓	✓	×	×	✓	×
720×480i@60	✓	×	✓	✓	×	×
720×480p@60	✓	×	×	✓	✓	✓
720×576i@50	✓	×	✓	✓	×	×
720×576p@50	✓	×	×	✓	✓	✓
800×600p@56/60/72/75/85	✓	✓	×	×	✓	×
848×480p@60	✓	✓	×	×	×	×
1024×768p@60/70/75/85	✓	✓	×	×	✓	×
1152×864p@75	✓	✓	×	×	×	×
1280×720p@50/60	✓	×	×	✓	✓	✓
1280×768p@60/75/85	✓	✓	×	×	✓	×
1280×800p@60/75/85	✓	✓	×	×	✓	×
1280×960p@60/85	✓	✓	×	×	×	×
1280×1024p@60/75/85	✓	✓	×	×	✓	×
1360×768p@60	✓	✓	×	×	✓	×
1366×768p@60	✓	✓	×	×	×	×
1400×1050p@60	✓	✓	×	×	×	×

Supported Resolutions (Hz)	Input				Output	
	HDMI	VGA	CV	YPbPr	HDMI	VGA
1440×900p@60/75	✓	✓	×	×	×	×
1600×900p@60RB	✓	✓	×	×	×	×
1600×1200p@60	✓	✓	×	×	✓	×
1680×1050p@60	✓	✓	×	×	✓	×
1920×1080i@50/60	✓	×	×	✓	✓	×
1920×1080p@24/25/30	✓	×	×	✓	✓	×
1920×1080p@50/60	✓	×	×	✓	✓	✓
1920×1200p@60RB	✓	✓	×	×	✓	×

8.3 Audio Specifications

8.3.1 Digital Audio

HDMI Input / Output	
LPCM	
Max Channels	2 Channels
Sampling Rate (kHz)	32, 44.1, 48, 88.2, 96, 176.4, 192
Bitstream	
Supported Formats	Standard

Coaxial Output (RCA)	
Max Audio Level	2Vrms
THD+N	< -80dB@0dBFS 1kHz (A-wt)
SNR	> 70dB@0dBFS
Frequency Response	< ±3dB@20Hz~20kHz
Crosstalk	< -60dB@10kHz
Impedance	100Ω
Type	Unbalanced

8.3.2 Analog Audio

Analog Input (3.5mm)	
Max Audio Level	2Vrms
Impedance	47kΩ
Type	Unbalanced
Analog Input (RCA)	
Max Audio Level	2Vrms
Impedance	47kΩ
Type	Unbalanced

Analog Output (3.5mm)	
Max Audio Level	2Vrms
THD+N	< -80dB@0dBFS 1kHz (A-wt)
SNR	> 70dB@0dBFS
Frequency Response	< ±3dB@20Hz~20kHz
Crosstalk	< -60dB@10kHz
Impedance	100Ω
Type	Unbalanced

8.4 Cable Specifications

Cable Length	HD	FHD	4K UHD	4K UHD ⁺	8K UHD
High Speed HDMI Cable					
HDMI Input	5m	5m	x		
HDMI Output	5m	5m	x		
VGA Cable					
VGA Input	2m	2m	x		
VGA Output	2m	2m	x		

Bandwidth Category Examples:

- **HD Video**

- 720p@60Hz
- HDMI transmission rates lower than 3Gbps
- HD-SDI (SMPTE 292M, 1.485Gbps)

- **FHD Video**

- 1080p@60Hz
- HDMI transmission rates between 3Gbps and 5.3Gbps
- 3G-SDI (SMPTE 424M, 2.970Gbps)

9. ACRONYMS

ACRONYM	COMPLETE TERM
ADC	Analog-to-Digital Converter
ARC	Audio Return Channel
ASCII	American Standard Code for Information Interchange
AV	Audio/Video
AVLC	Adaptive Visually Lossless Compression
AVR	Audio/Video Receiver or Recorder
Cat.5e	Enhanced Category 5 cable
Cat.6	Category 6 cable
Cat.6A	Augmented Category 6 cable
Cat.7	Category 7 cable
CEC	Consumer Electronics Control
CLI	Command-Line Interface
COAX	Coaxial
COM	Communication
DAC	Digital-to-Analog Converter
dB	Decibel
DHCP	Dynamic Host Configuration Protocol
DVI	Digital Visual Interface
eARC	Enhanced Audio Return Channel
EDID	Extended Display Identification Data
GbE	Gigabit Ethernet
Gbps	Gigabits per second
GUI	Graphical User Interface
HD	High-Definition
HDBT	HDBaseT
HDCP	High-bandwidth Digital Content Protection
HDMI	High-Definition Multimedia Interface
HDR	High Dynamic Range

ACRONYM	COMPLETE TERM
HDTV	High-Definition Television
HID	Human Interface Device
HPD	Hot Plug Detection
I²C	Inter-Integrated Circuit
I²S	Inter-IC Sound
IEEE	Institute of Electrical and Electronics Engineers
IGMP	Internet Group Management Protocol
IP	Internet Protocol
IR	Infrared
kHz	Kilohertz
KVM	Keyboard/Video/Mouse
LAN	Local Area Network
LCD	Liquid-Crystal Display
LED	Light-Emitting Diode
LPCM	Linear Pulse-Code Modulation
MAC	Media Access Control
MJPEG	Motion JPEG
MHz	Megahertz
OSD	On-Screen Display
SDTV	Standard-Definition Television
SNR	Signal-to-Noise Ratio
TCP	Transmission Control Protocol
THD+N	Total Harmonic Distortion plus Noise
TMDs	Transition-Minimized Differential Signaling
UAC	USB Audio Class
UHDTV	Ultra-High-Definition Television
USB	Universal Serial Bus
UVC	USB Video Class
VGA	Video Graphics Array

ACRONYM	COMPLETE TERM
VLAN	Virtual LAN
VoIP	Video over IP
WUXGA (RB)	Widescreen Ultra Extended Graphics Array (Reduced Blanking)
XGA	Extended Graphics Array
Ω	Ohm



CYPRESS TECHNOLOGY CO., LTD.
www.cypress.com.tw
