

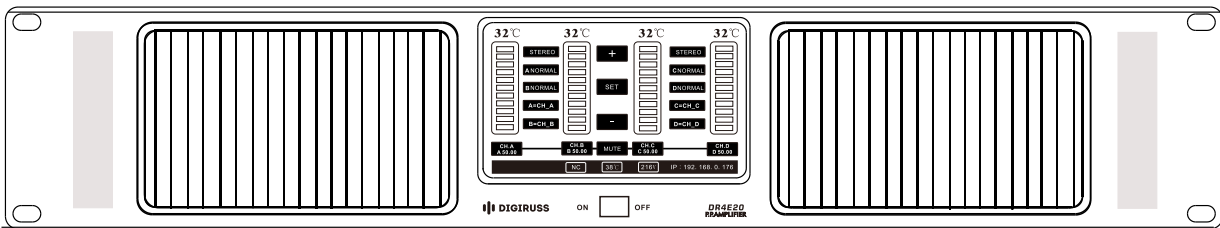

Professional Power Amplifier

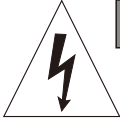

For your protection, please read this manual, completely before operating the appliance and keep this manual for future reference.

	<div style="background-color: #cccccc; padding: 5px; font-weight: bold; font-size: 1.2em;">CAUTION</div> <p>RISK OF ELECTRIC SHOCK DO NOT OPEN</p>	
<p>CAUTION: TO REDUCE THE RISK OF ELECTRIC SHOCK. DO NOT REMOVE TOP OR BOTTOM COVER. NO USER SERVICEABLE PARTS INSIDE. REFER SERVICING TO QUALIFIED SERVICE PERSONNEL.</p>		

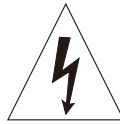

The lightning flash with arrowhead symbol within an equilateral triangle is intended to alert the user to the presence of uninsulated "dangerous voltage" within the product's enclosure, that may be of sufficient magnitude to constitute a risk of electric shock to persons.



The exclamation point within an equilateral triangle is intended to alert the user to the presence of important operating and maintenance (Servicing) instruction in the literature accompanying the appliance.

IMPORTANT SAFETY INSTRUCTIONS

INSTRUCTIONS PERTAINING TO A RISK OF FIRE, ELECTRIC SHOCK OR INJURY TO PERSONS

WARNING- When using electric products, basic precautions should always be followed, including the following:

1. Read all the SAFETY INSTRUCTIONS before using the product.
2. This product must be earthed. If it should malfunction or break down, grounding provides a path of least resistance for electric current to reduce risk of electric shock.
This product is equipped with a cord having an equipment-grounding conductor and a grounding plug. The plug must be plugged into an appropriate outlet that is properly installed and earthed in accordance with all local codes and ordinance.
DANGER- Improper connection of the equipment-grounding conductor can result in a risk of electric shock. Check with a qualified electrician or serviceman if you are in doubt as to whether the product is properly grounded. Do not modify the plug provided with the product-if it will not fit the outlet, have a proper outlet installed by a qualified electrician.
3. To reduce the risk of injury, close supervision is necessary when the product is used near children.
4. Do not use this product near water-for example, near a bathtub, washbowl, kitchen sink, in wet basement or near a swimming pool or the like.
5. This product may be capable of producing sound levels that could cause permanent hearing loss. Do not operate for a long period of time at high volume level or at a level that is uncomfortable. If you experience any hearing loss or ringing in the ears, you should consult an audiologist.
6. This product should be located so that its location or position does not interfere with its proper ventilation.
7. This product should be located away from heat sources such as radiators, heat registers or other products that produce heat.
8. The product should be connected to a power supply only of the type described on the operating instructions or as marked on the product.
9. This product may be equipped with a polarized line plug (one blade wider than the other). This is a safety feature. If you are unable to insert the plug into the outlet, contact an electrician to replace your obsolete outlet. Do not defeat the safety purpose of the plug.
10. The power-supply cord of the product should be unplugged from the outlet when left unused for a long period of time. When unplugging the power-supply cord, do not pull on the cord, but grasp it by the plug.
11. Care should be taken so that objects do not fall and liquid are not spilled into the enclosure through openings.
12. The product should be serviced by qualified service personnel when:
 - A. The power-supply cord or the plug has been damaged; or
 - B. Objects have fallen, or liquid has been spilled into the product; or
 - C. The product has been exposed to rain; or
 - D. The product does not appear to operate normally or exhibits a marked change in performance; or
 - E. The product has been dropped or the enclosure damaged.
13. Do not attempt to service the product beyond that described in the user-maintenance instructions. All other servicing should be referred to qualified service personnel.
14. **WARNING:** Do not place objects on the product's power cord or place it in a position where anyone could trip over, walk on or roll anything over it. Do not allow the product to rest on or to be installed over power cords of any type. Improper installations of this type create the possibility of fire hazard and or personal injury.

SAVE THESE INSTRUCTIONS

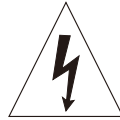
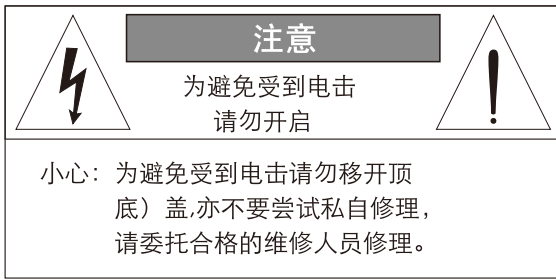

重要的安全事项 (针对火灾、电击或伤害人体的指示)

注意： 使用电器产品时，有以下基本的预防措施，以下包括：

- 1、使用该产品前请详细阅读全部的安全事项；
- 2、本产品应当接地，如果出现故障时，电流经最小的接地电阻流入大地，以减小电击；本产品的电源线和电源插头都配备安全接地，电源插头应当牢固插入适当的电源座，此电源座应当完全按当地的条例来安装和接地。

警告： 接地装置连接不当会导致电击；如果你对产品是否正确接地存在任何疑问，请委托合格电工或维修人员检查；请不要尝试私自更改产品的电源插头，如果不适合电源插座，可委托合格电工安装适当的电源插座。

- 3、为了减小伤害的风险，当产品在小孩附近使用时，要严密监管。
- 4、请勿在湿度很高的地方使用机器，例如靠近浴缸、洗脸盆、厨房水槽、温度很大的地下室或者靠近游泳池和湖泊。
- 5、该产品有可能产生导致永久性听觉丧失的音量，请勿长时间在很大或令人很不舒服的音量下动作。如果你察觉到有任何听力丧失或者耳朵发响，应当咨询听觉病矫正专家。
- 6、该产品应当安装于通风良好的地方。
- 7、该产品必须远离热源，例如电暖炉、电热毯或者其他产生热量的产品。
- 8、该产品的电源类型必须符合操作提示或者产品上标明的类型。
- 9、该产品要配备一条两端的电源线（一端的插片长过另一端）。这是安全装置。如果你无法把电源插头插入电源插座，请联系电工来更换旧插座。请勿破坏电源插头的安全装置。
- 10、长时间不使用时，请把电源线从电源插座中拔出，从电源座拔出电源线时，请勿拉扯电源线，应当抓住电源插头将其拔出。
- 11、细心护理，请勿让杂物或液体从其缝隙掉进机内。
- 12、当有下列情况时，应委托合格维修人员修理。
 - A、电源线或电源插头已被损坏；
 - B、杂物或液体已掉进机内；
 - C、产品已被雨淋；
 - D、产品已不能正常操作或在演出中出现明显变化；
 - E、产品已跌坏或外观损坏。
- 13、当出现没在用户维修指南中描述的情况时，请勿尝试私自修理，应当委托合格的维修人员修理。
- 14、**警告：** 勿让重物积压或踩踏电源线，切忌拉、拔或强力扭曲电源线。
勿滥用电量线，不合格的电源线可能导致火灾或对人造成伤害。

请保存这些安全事项



CATALOGUE



Catalogue	1
Installation & operating instruction	3
Functions & controls instruction	5
Technical specifications	11
Connector cables	12

目录

目录	2
安装和操作说明	4
功能和控制说明 (DSP系列)	5
技术指标 (DSP系列)	11
连接线材	13

Installation & operating instruction



✓ Mains power connection.

Before connecting the amplifier to the mains power socket, make certain that the voltage corresponds with that indicated on the rear of the unit (AC220V \pm 10%). Before connecting the power cable to the mains, always make certain that it is not damaged and that there are no bare wires, always connect the power cable to the amplifier before switching it on and only remove the cable after switching it off.

✓ Switching on and off

In an audio system, it's always better to switch power amplifiers on last and off first. Remember to switch off the amplifier before connecting it to or disconnecting it from other units and to switch always on first the mixer and then the amplifier: in this manner, peaks which are annoying and sometimes dangerous particularly for the loudspeakers enclosures are avoided. It is normal for the LEDs to light up for a few moments when switching on.

✓ Handling

Do not force knobs and connectors, as they could be damaged if treated with excessive force.

✓ Connections and prevention of possible interference

Avoid installing your equipment near radios, televisions, etc, since they could cause noisy disturbance.

✓ Connector cables

To connect the amplifier to the mixer, always make certain to use only signal cables (screened cables made up of two wires plus a braid screen), not power cables (speaker cables, normally made up of two wires, usually with a greater cross-section): to connect the amplifier to the loudspeaker enclosures, always use power cables, not signal cables, as in the latter case in fact, the power from the amplifiers would be partially dispersed because of the cable's smaller cross-section. Take care of the connector cables. Always hold them by the connectors, avoiding pulling the wire and avoid knots and twists when coiling them: this gives the advantage of increasing their life and reliability.

✓ Air circulation for cooling

Amplifier's correct cooling is ensured by internal fans, the speed of which is controlled by special sensors (the speed is proportional to output power; remember never to block the air vents in any way: the air necessary for cooling passes through these. If the amplifier is kept in a flight-case during use, make certain that it has sufficient openings at both the amplifier's air vents. Avoid locating it in very small spaces which don't allow correct air circulation.

✓ Warning High Voltage

Please attention fan-out high voltage, and polarity, not short circuit.
When the product is work, don't touch the output connector for safety.

安装及操作说明

主电源的连接

- ① 将功放连接到电源插座之前，请确认电源电压符合功放后板下所标注的电压要求，(AC220V±10%)。将电源接上电源插座之前，请确认电源线没损坏。在开机前连好电源线；在关机后拔掉电源线。

开关机



- ② 在音响系统里面，功放是最迟打开及最早关闭。在连接其它设备时，要关掉功放。先打开调音台，后打开功放。按此顺序，避免对音箱造成损害。

注意

- ③ 为了保护好电源线和连接线，不允许用力挤压电源线和连接线。

抗干扰

- ④ 避免干扰，切勿将音响设备安装在靠近无线电装置，电视机等等的地方。

不得受雨淋或水溅

- ⑤ 勿将本机放置在湿度很高的地方，不能受雨淋或水溅。有水的物体不能摆在本机的上方。避免在本机附近喷洒杀虫剂或使用化学品如酒精、涂料、稀释剂、松香水等溶剂抹机箱。

风槽

- ⑥ 为了保证功放的正常工作，切勿阻塞风槽（进风口和出风口）如果功放在很恶劣的环境下使用，请确认在功放周围有足够的空间。避免将功放安置于狭小，不利于空气流通的地方。

注意高压

- ⑦ 注意输出端高压、极性，请勿短路。在本机工作时，请勿触摸本机的输出端子，否则有可能对人造成伤害。

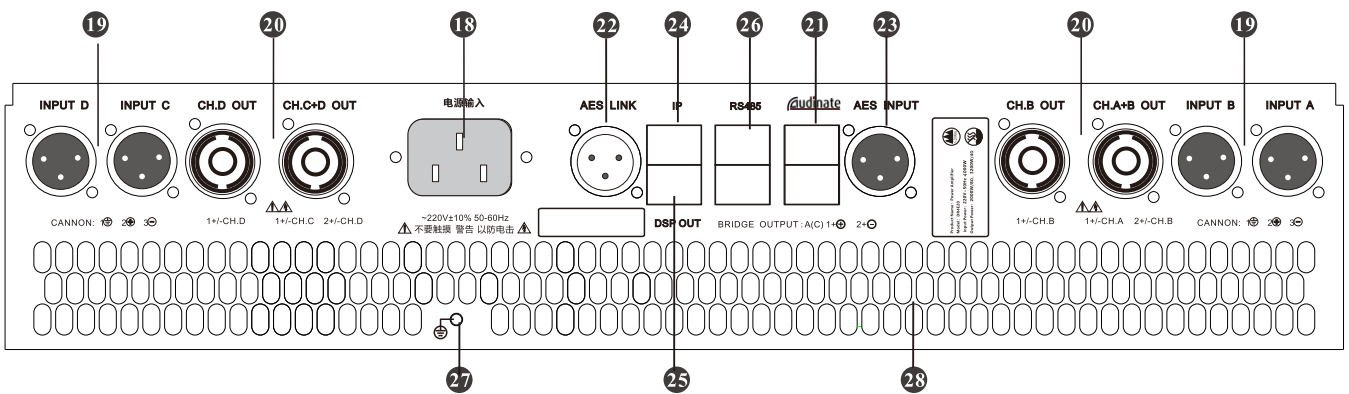
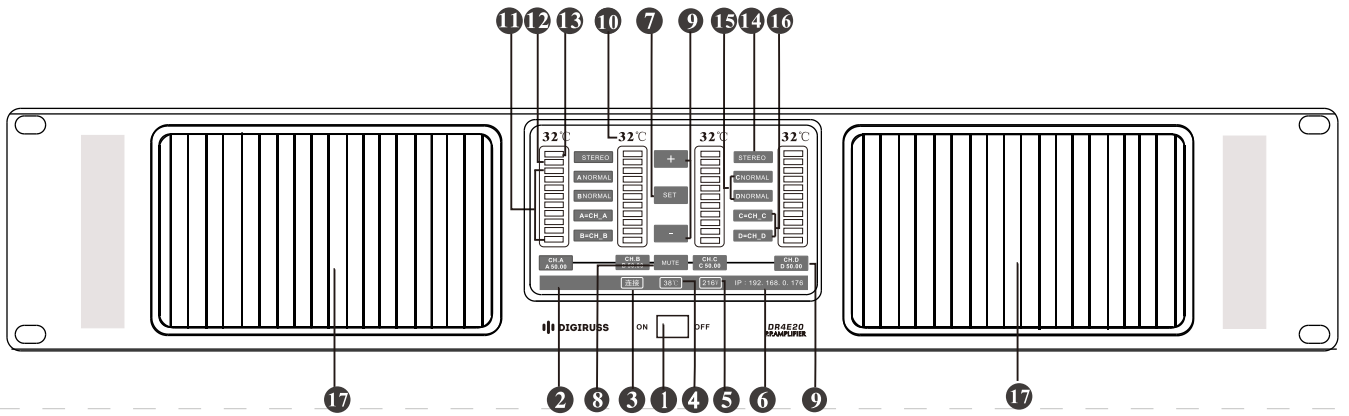

① **Power Switch**

ON/OFF switch with indication LED. (Active LED)

① **电源开关**

打开及关闭本机电源：开机软启动电流 < 8A。

带开机延迟接载，关机即时断载。无冲击电流输出，保护扬声器。

② **Name Of This Power Amplifier**

Enter the function setting interface and click " SYSTEM, Amp Name" to set the name

② **本机名称** 进入功能设置界面，点击“系统设置，本机名称”，输入标识字符。

③ **Computer Controlled Connection Display**

Display that the computer control software and power amplifier are successfully connected.

③ **PC 控制软件连接显示** PC 端控制软件连接本机成功显示。

④ **The Temperature Of Power Board Display**

④ **电源温度显示** 开关电源工作温度实时显示，超过80°C时，自动减小输出功率，不断载。

⑤ **The Mains Input Voltage Display**

⑤ **市电输入电压显示** 电源输入电压值 (180-250V)，即时显示。

⑥ **IP Address**

Displayed The link status of the IP network port . When the link is successful, it will turn green, and if there is no link, it will turn white.

⑥ **IP 地址显示**

显示IP 网络端口链接状态，链接成功时变为绿色，无链接为白色底。

7 Setup Button

Click this button to enter the password input interface. After entering the correct password, you can enter the menu interface. (No password by default. If you need to set a password, please select System Settings, and change the password.)

When the amplifier has 3 minutes no operation, the amplifier will automatically locked. All button can not control in the locked state. Press and hold the screen for 3 seconds to unlock.

7 设置键

点击该设置键进入密码界面，输入正确密码后，即可进入功能设置界面。（默认无密码，如需设置密码，请进入功能设置界面，选择“系统设置”修改密码。）

当待机显示界面超过3分钟没有操作，本机自动锁屏，锁定后所有按键不可调。长按屏幕3秒可解锁。

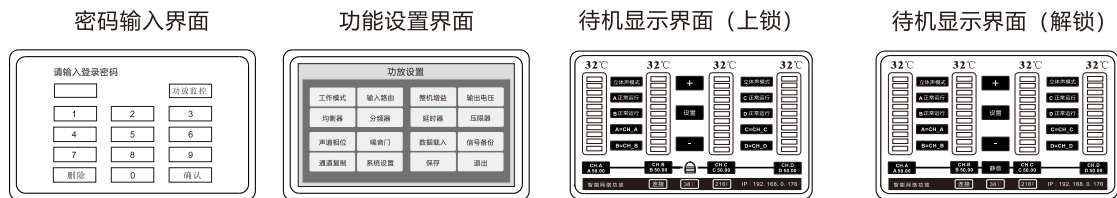

8 Mute Button

Click this button to mute/no output, and click again to restore the volume from low to high.

8 静音键 点击该键静音/无输出，再点则音量从小到大恢复。

9 LEVEL

It can control the volume of each channel in 0.25dB steps.

9 音量调控键

控制通道音量，量程 0-50dB，+ 增大，- 减少，步进 0.25dB。

10 Channel Temperature Display

Each channel independently displays the real-time working temperature, automatically reduces the output power of the channel when it exceeds 80°, and keeps working

10 通道温度显示 每通道独立显示即时工作温度，超过80°时自动减小该通道输出功率，不断载。

11 *Signal LEDS*

When the power amplifier has output, the signal indicator light will blink and work normally.

11 信号指示灯

当本机有输出时，信号指示灯会闪烁，工作正常。

12 *Limit LEDs*

On/off display: When the indicator light is green, the load is connected, and when the indicator is red, the load is disconnected

12 削峰指示灯

当削峰指示灯亮时，表示本机的输入信号已过大而产生失真，应减小音量，使其工作在安全范围内。

13 *Load (loudspeaker)*

On/off display: When the indicator light is green, the load is connected, and when the indicator is red, the load is disconnected

13 负载（扬声器）

通/断显示：指示灯绿色为接通负载，红色为断开负载。

14 *Stereo/Bridge Display*

14 立体声/桥接指示 进入功能设置界面，选择“工作模式”设置立体声/桥接功能。

15 *Protect LED*

If this LED light up, this indicates that one of the various protections safeguarding the different sections of the amplifier and the loudspeaker enclosures has tripped due to an operating fault. In these cases, the power output is normally switched off until normal operating conditions are restored.

The following is a description of all the series protections

- 1) Switch on AC soft working Protection: Limit the electric current when start up, don't affect the others equipments or out the rush of circuit inside.*
- 2) Delay the link load: protect the loudspeaker, keep silence when start up.*
- 3) Circuit damage protection: midpoint excursion and output the AC, limit the damage to extend.*
- 4) Limit the output current Soft protection: The loading impedance is low and too drastic signal; it can protect the loudspeaker and amplifier.*
- 5) Clip and compress protection: When input too big signal, the clip output is distortion, it is easy to damage the speaker unit; this circuit can check the compress signal to protect the loudspeaker .*
- 6) Short Circuit Protection: trips in the event of a short-circuit or overload, limiting the output current.*
- 7) Over hot protection: In high temperature and low overload state, the temperature grow hot quickly, the protect will work to cut the load over 80°C. The amplifier will rework below 70°C.*
- 8) Switch off Protection: First turn off the overload when switch off, it keep the loudspeaker silence out of the rush.*

15 工作状态：正常/保护

如果保护灯显示红色，这表明本机的保护电路起控，可能因负载问题或者线路故障，保护电路通过继电器切断输出，保护扬声器。

产品的保护电路说明如下：

- 1) 电源开机交流软启动：抑制启动电流，不影响其它设备工作和保护机内电路免受冲击。
- 2) 开机延时接载：保护扬声器免受冲击，无声开机。
- 3) 直流输出断载保护：中点漂移和有直流输出时，防止音箱受冲击而损坏。
- 4) 过流自动跟踪输出限流软保护：当负载阻抗过低和输入信号过大时，对本机和扬声器保护。
- 5) 削波保护：当输入信号过大时，使本机削峰失真输出，容易损坏喇叭，本电路能自动跟随负载阻抗并减小信号，保护扬声器。
- 6) 负载短路保护：当负载短路时，短路电流过大，自动切断输出保护本机。当短路解除后自动恢复，若负载长时间短路，则关闭信号无输出，需重新开机恢复工作。
- 7) 过热保护：在高温环境或低阻抗负载工作时，机内温升较快，当功率组件温度超过80°C时，过热保护自动起控，减小输出功率（若高于90°C切断输出），当温度低于70°C时自动恢复正常工作。
- 8) 关机保护：关机时立即切断负载，实现无声关机，保护扬声器免受冲击。



有些保护电路需要把功放关掉然后重启，才能恢复正常的操作状态。

16 *Displays The Setting Status Of The Channel Route*

16 显示通道路由的设置状态

进入功能设置界面，选择“路由”，设置通道路由：CH.A /B/C/D, DANTE 1/2/3/4, AES 1/2。

17 *Air Inlet*

17 进风孔 本机采用智能温控风冷散热，请保持进风畅通，不被灰尘堵塞和其他物体遮挡造成过热保护。

18 *Power Interface*

18 电源输入接口 市电输入安全范围：220V±10%，50Hz，0.4-16A。

19 *InPuts*

19 信号输入端口

卡侬座平衡输入：1脚接地 \ominus ，2脚 \oplus ，3脚 \ominus 。

20 *OutPuts : Connect the speaker*

20 功率输出端口

通道功率输出：NL4 四芯座，每通道一个连接到音箱。1+为 \oplus ，1-为 \ominus 。

桥接功率输出：A通道输出座 NL4，1+为 \oplus ，B通道输出座 NL4，2+为 \ominus 。



扬声器（或者音箱系统）阻抗和承受功率必须与本机输出功率和阻抗合理匹配。（请详看技术规格书）

请使用标准音频功率传输线连接。

21 *Dante Digital Signal Input Port*

21 Dante 信号输入端口

22 *AES Digital Signal Output Port*

22 AES 数字信号输出端口

23 *AES Digital Signal Input Port*

23 AES 数字信号输入

24 *PC Control Software Communication Port*

24 PC 控制软件通讯端口

25 *DSP Signal Output Port*

25 DSP 输出信号端口

26 *Power Amplifier Main/standby Switch Communication Port*

26 功放主/备切换通讯端口

27 *Grounding Screw*

27 接地螺丝 为人员安全，防止触电，请妥善接地后使用。

28 *Air Outlet*

28 出风口 本机采用智能温控风冷散热，请保持出风口畅通，不可被其他物体堵塞遮挡造成过热保护。

Power Amplifier Technical Parameter Table

Nanocrystalline switching power supply + Class TD (digital-analog) amplifier + High-performance processor + Intelligent network control system

Model (4-CH)	DR4E7	DR4E10	DR4E13	DR4E16	DR4E20
Output Power (RMS) : 8Ω	700W	1000W	1300W	1600W	2000W
Output Power (RMS) : 4Ω / 2Ω	1100W	1600W	2000W	2400W	3200W
Output Power (RMS) : Bridge 8/ 4Ω	1800W	2500W	3200W	4000W	4800W
Output Voltage/Power (V/W)	10-75V	10-90V	10-105V	10-115V	10-130V
Dante、AES transmission + IP communication	√	√	√	√	√
Input Signal Matrix + Signal hot backup	√	√	√	√	√
DSP with FIR、Frequency delay function	√	√	√	√	√
Data Presets (save) 100pcs (groups)	√	√	√	√	√
PC Remote monitoring + Central control	√	√	√	√	√
PC Grouping and joint control: multi-units (multi-channels)	√	√	√	√	√
PC Remote soft power on/off (multi-units joint control)	√	√	√	√	√
PC Remote Mute (multi-units joint control)	√	√	√	√	√
Color screen display + Touch screen control	√	√	√	√	√
Automatically dark the screen + Automatically lock the screen (180s)	√	√	√	√	√
Temperature display + Intelligent temperature control	√	√	√	√	√
AGC	√	√	√	√	√
PFC	√	√	√	√	√
Dynamic display of load on/off (per channel)	option	option	option	option	option
Remote hard switch	option	option	option	option	option
DSP audio control output (2 channels)	option	option	option	option	option
※ Monitoring output: Digital display of each channel's current, voltage, impedance, power, temperature, and load on/off.					
Input impedance (single channel)	20KΩ (Bal/Single channel)		10KΩ (unbal/ two channels in parallel)		
Input Sensitivity /Gain	0 dB -15dB		/ 30dB - 45dB (Each channel could be adjustable)		
Electronic Volume / Channel Separation	0dB - 50dB, Step 0.25dB		/ > 60dB (8Ω 1KHz)		
Conversion Rate / Damping factor	> 20V/us (8Ω 1KHz)		/ > 300 (8Ω 1KHz)		
SNR / Frequency response	> 100dB (A weighted)		/ < ± 0.5dB (8Ω 30W 20-20000Hz)		
THD+H / Intermodulation distortion	< 0.08% (8Ω 30W)		/ < 0.3% (8Ω 30W)		
Power supply voltage/current	AC180V - 250V/50Hz		/ 0.4-16A (RMS)		
Overall efficiency / starting current	80% (8Ω 1KHz)		/ Start soft start current: < 8A		
Rear Panel inpu / output	Power input socket X 1, Signal input XLR socket X 4, AES input XLR (male/female) X 1 IP connection socket X 1, RS485 X 2, Dante X 2, DSP OUT X 1, Power output socket X 4				
Dimension	2U 483mm × 88mm × 475mm				
Net Weight	14kg	16kg	16kg	16kg	16kg

Connector cables

The following diagrams illustrate the wiring of the various types of sockets that can be used with the power amplifiers.

To connect the amplifier to the mixer, always make certain to use only signal cables (screened cables made up of two wires plus a braid screen), not power cables (speaker cables, normally made up of two wires, usually with a greater cross-section): the use of unscreened cables could in fact cause annoying buzzes and background noise. The amplifier's inputs are in fact balanced and therefore designed in such a way that any interference on the line is eliminated or at least greatly reduced. We therefore always suggest the use of balanced cables for microphones and line units whenever possible.

To connect the amplifier to the loudspeaker enclosures, always use only power cables, not signal cables, as in the latter case in fact, the power from the amplifiers would be partially dispersed because of the cable's smaller cross-section.

Take care of the connector cables. Always hold them by the connectors, avoiding pulling the wire and avoid knots and twists when coiling them: this gives the advantage of increasing their life and reliability. Check your cables periodically, making certain that they are in good condition, that the connectors are correctly wired and contacts perfectly efficient: in fact, many problems and setbacks (faulty contacts, ground hum, disturbance, etc.) are due to the use of unsuitable or faulty cables.

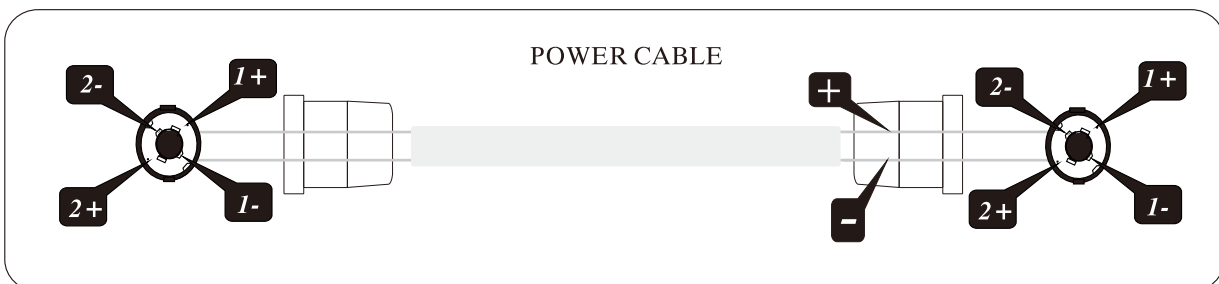
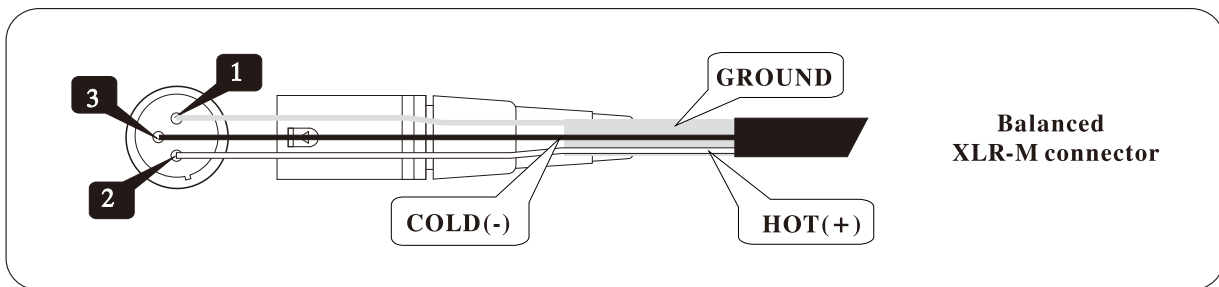

连接线材

下面说明各系列功放上使用各种线材:

连接功放和调音台,只使用信号线(这种线由一个屏蔽网和屏蔽网内的两根线组成),不要使用电力电缆(音箱线,截面积较大,由两根线组成)。使用没有屏蔽网的线材会引起讨厌的嗡嗡声和背景噪音。各系列功放都是平衡输入的,这种设计会消除或者减少输入线上的干扰。很多知名专家一直以来都建议尽量在连接功放与其它前置音频设备时采用平衡输入的方式。连接功放和音箱,通常只使用电缆,而不是信号线,因为截面积较小的电缆会耗散功放输出功率。注意保护连接线材。通常抓住线材末端而提起它,避免在卷起时,拉扯和强力弯曲线材,因为这样会缩短它们使用寿命和降低可靠性。定期检查线材,检查线材是否正确和接触是否良好。实际上,很多问题是由于连接线材有问题而引起的。

