

DIGIRUSS

DW960R

WIRELESS MICROPHONE

USER MANUAL

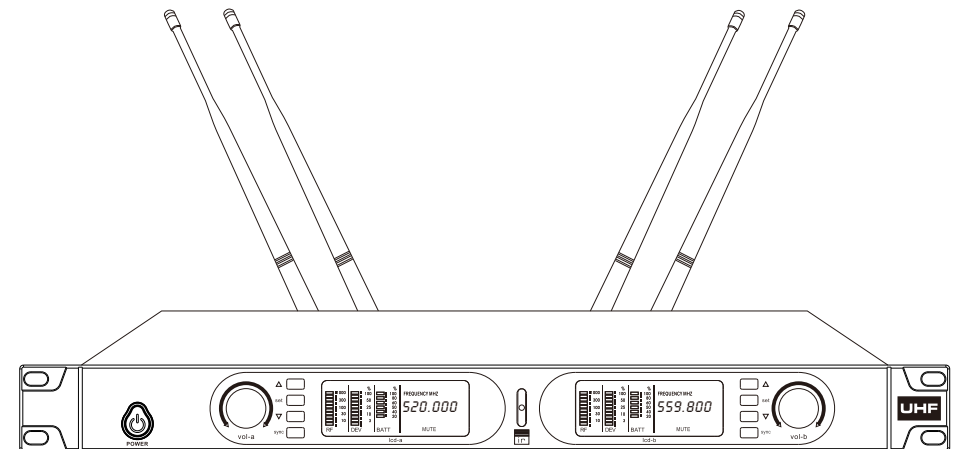



UHF Wireless Microphone

As the product is constantly improving, there won't be any further notice for the improvement.

Thank you for choosing our products
Please read the manual carefully to get the best performance effect.

General Description1
Product Feature2
Accessories3
Front Panel4
Rear Panel.....5
LCD Display Operation Instructions.....5
Frequency Setting6-7
Handheld Microphone8
Technical Specifications9
Use Guidelines10

	CAUTION RISK OF ELECTRIC SHOCK DO NOT OPEN	
<p>To prevent electric shock, do not remove top or bottom covers. No user serviceable parts inside. Refer servicing to qualified service personnel. Disconnect power cord before removing rear input module to access gain switch.</p>		



WARNING To reduce the risk of electric shock, do not expose this equipment to rain or moisture!

Troubleshooting

Problem	
No sound: Channel not glowing.	<ul style="list-style-type: none"> ● Make sure the transmitter and receiver POWER switches are ON. ● Check battery. ● Check receiver squelch setting. ● Check receiver antenna connection(s). ● Make sure antennas are in line of sight of transmitter.
No sound: Indicator and audio level mater lights glowing.	<ul style="list-style-type: none"> ● Turn up receiver audio VOLUME control. ● Check for proper connection between receiver and karaoke unit. ● Talk into microphone and observe receiver audio level lights. If they glow, the problem is elsewhere in the sound system.
Received signal is noisy or contains extraneous sounds with transmitter on.	<ul style="list-style-type: none"> ● Check battery. ● Remove local sources of RF interference. ● If using a guitar or other instrument, check connections. ● Two transmitters way be operating on the same frequency. Locate and turn one off. ● Signal may be too weak. Reposition antennas. If possible, move them closer to transmitter.
Noise from receiver with transmitter off.	<ul style="list-style-type: none"> ● Adjust receiver squelch control. ● Remove local sources RF interference. ● Reposition receiver or antennas.
Momentary loss of sound as transmitter is moved around performing area.	<ul style="list-style-type: none"> ● Reposition receiver and perform another walkthrough test and observe the RF indicators. If audio dropouts persist, mark these dead spots in performing area and avoid them during performance.

Thanks for purchasing this products. Please read this instruction carefully before using the system so that you can make sure in detail by the numbers how to install, operate and safeguard the system.

Our wireless microphone system has characteristics as the following. For many reasons, such as low frequency, traditional wireless microphone system are easy to be interfered, especially because many machines, CD, VCD and LD, eradicate out too many harmonic. To solve this problem. We design this kind of true diversity professional wireless microphone. We adopt a series of measures to improve its functions, advance frequency, using multilevel high frequency and mid frequency narrowband filter, multiple noise detect and control.

Product Feature

1. Adjustable dual channel UHF wireless system, 200 channels can be selected.
2. The infrared frequency-locking frequency is locked. The receiver uses dual LCD screens to display the working status of the system.
3. The receiver and the transmitter use IR infrared frequency synchronization technology to synchronize code with one button.
4. Professional performance-level phase lock circuit. Good for karaoke and singing.
5. Back light LED display indicates RF and AF signal strength, battery status, channel indication (A / B), frequency, channels etc.
6. Using "Audio Compression and Expansion" patent technology. Has excellent dynamic response and excellent sound quality.

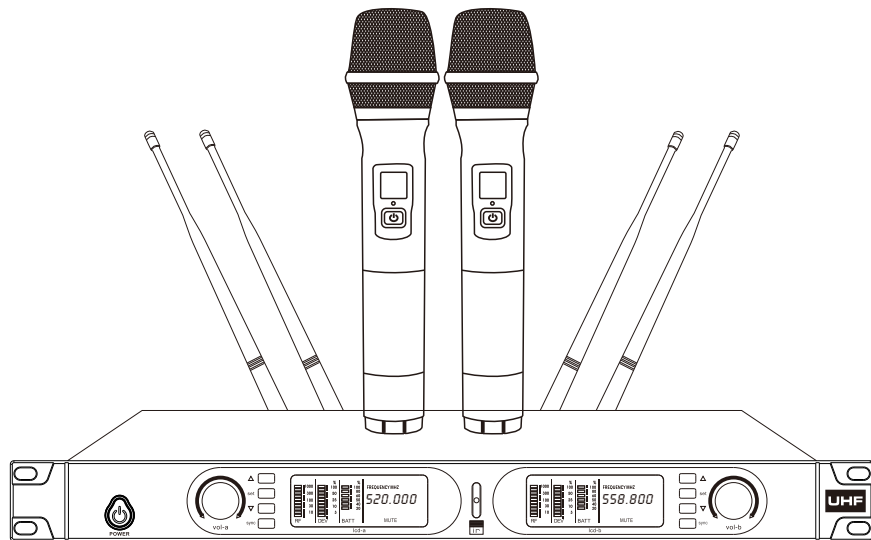

Accessories

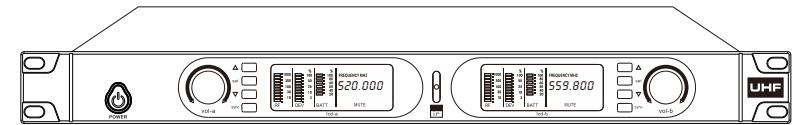

Receiver: 1pcs

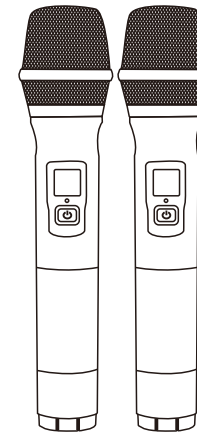

Microphone: 2pcs
(Handheld/Lapel/Headset/Desktop optional)

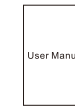

User Manual: 1pcs

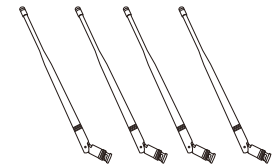

Antenna: 4pcs



6.35 Audio Cable: 1pcs

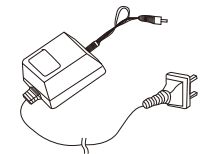

Adapter: 1pcs

Frequency Matching

- 3.2 Aim the transmitter IR window to the receiver IR window.
(The label and the headset body pack need to open the transmitter battery compartment, the conference unit IR window is located on the rear panel)
Operation as below picture:

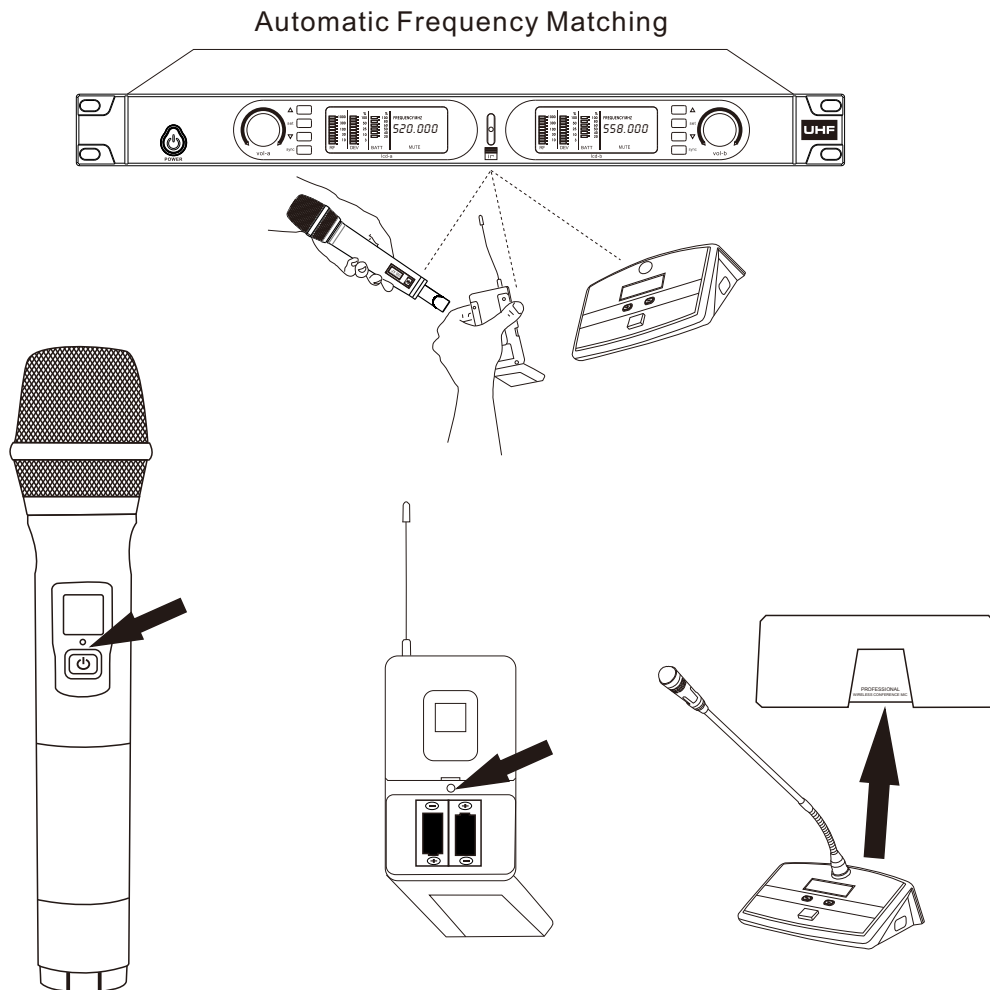

Technical Specifications

System specification:

Frequency Range: 520.000-559.800MHz
Channel A: 520.000-539.800MHz (100 Channels)
Channel B: 540.000-559.800MHz (100 Channels)
Number of Channels: 200 Channels
Frequency step: 200KHz
Modulation Type: FM
Brake Bias: 45KHz
Frequency Error: <10PPM
Dynamic Range: >110dB
Frequency Response: 60Hz-18KHz
S/N Ratio: >105dB
Distortion: <0.5%
Operating Temperature: -18°C~+50°C
Visual Receiving Distance: 100 Meters

Receiver specification:

Oscillation mode: PLL Phase Locked Loop
Antenna interface: TNC Connector
Receiving Sensitivity: -100dBm(40dB S/N)
Spurious Suppression: >80dB
Audio Output: +4dB(1.25V)/5KQ
Balanced: +10dB(1.5V)/600Q
Frequency Error: <10PPM
Supply Voltage: DC12V
Supply Current: 450mA
Power consumption: 5mW

Front Panel

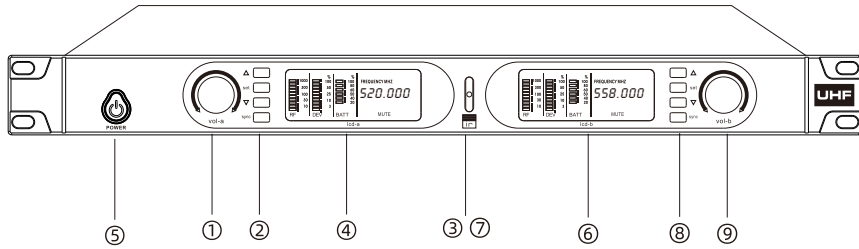

- ①. Channel A volume adjustment
- ②. Channel A upward, down, set and sync functions button
- ③. Channel A infrared display window
- ④. Channel A LCD display
- ⑤. Power switch
- ⑥. Channel B LCD display
- ⑦. Channel B infrared display window
- ⑧. Channel B upward, down, set and sync functions button
- ⑨. Channel B volume adjustment

3. Frequency Lock

- 1) Press 4 times "set" key to enter lock setting;
- 2) Press "Δ" to lock the frequency or press "▽" to unlock the frequency;
- 3) Press "set" to confirm.

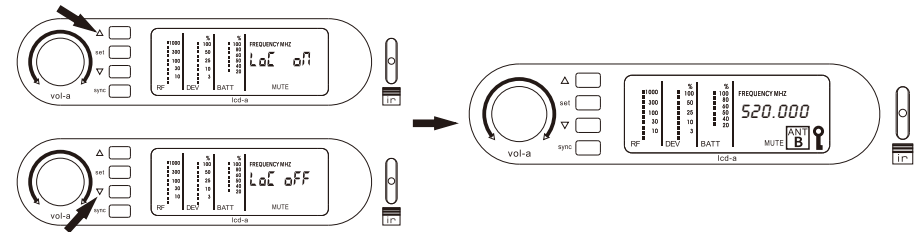

4. Sensitivity setting

Press the "set" key 3 times to enter MIC sensitivity setting, then press the "Δ" and "▽" key to select the MIC sensitivity level. There are 3 levels for different application ("-95"/"-85"/"-75")

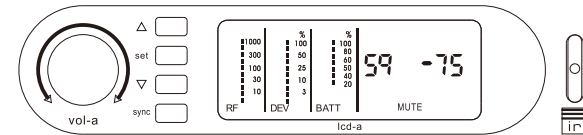

5. Frequency setting

Press the "sync" key, you can see the IR light is flashing. Then face the transmitter IR window to the receiver IR window. When the LCD show the frequency, then frequency matching is successfully.

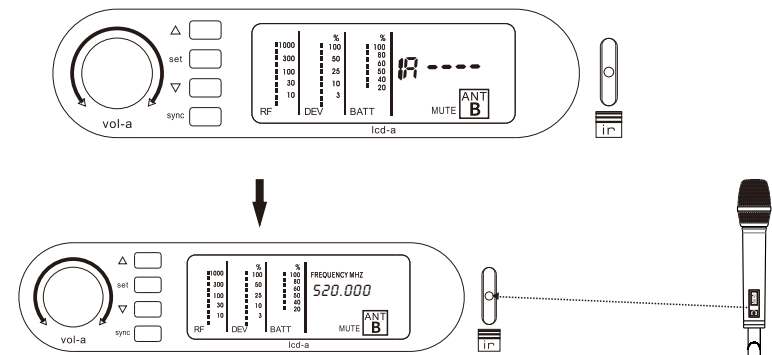

Function Instructions

1. Automatic frequency sweep

1) Press "set" key 2 times (show as chart 1), then press the "Δ" key, then the host will search the clean frequency point automatically (chart 2).
 2) When the LCD shows as chart 3 and the IR window is flashing, face the transmitter IR window to the host window. When the LCD shows the frequency (show as chart 4), frequency matching is successful.

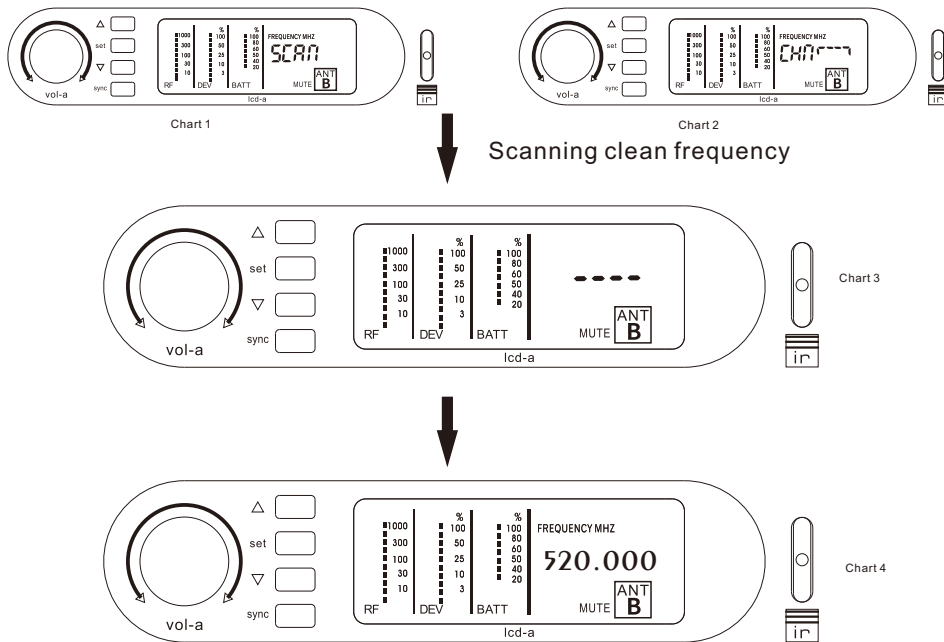

2. Channel setting

1) Press the "set" key into the channel adjustment interface.
 2) Press the "Δ" and "▽" key to switch the channel,
 3) then press "set" to confirm, face the transmitter IR window to the host window. When the LCD shows the frequency, frequency matching is successful.

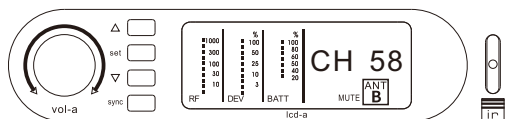

Rear Panel

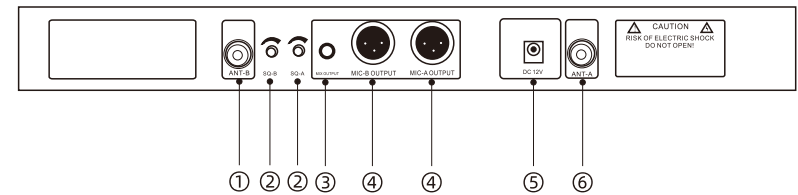

- ①. Antenna socket
- ②. Channel A/B squelch gate level adjustment
- ③. 6.35 audio mixing output outlet
- ④. XLR balance output interface
- ⑤. Power supply socket, 12V DC input voltage.
- ⑥. Antenna socket

LCD Display Operation Instructions

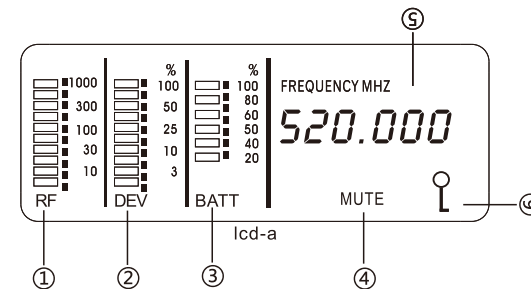

- ① RF output display
- ② DEV audio output display
- ③ Battery level display
- ④ Mute display
- ⑤ Frequency display
- ⑥ Frequency lock

Handheld Microphone

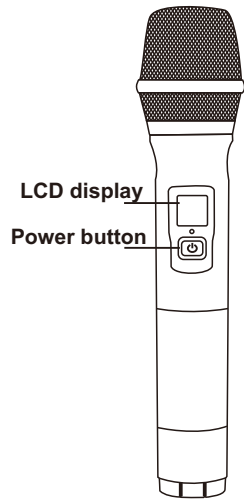

Switch on

Long press the power button about 3 seconds, when the LCD screen will display the current channel, power consumption(as shown)

Switch off

Long press the power button for 3 seconds, the LCD screen will display OFF, Then display will be turn off

Handheld mic

Transmitter specification:

- Oscillation mode: PLL Phase Locked Loop
- Transmitter Power: 1.6mW (Handheld Microphone)
- Frequency Error: <10PPM
- Supply voltage : 1. 5Vx2 Battery

Conference Microphone

1. Conference Mic Instruction

1.1 Panel Instrction

- ① Microphone Head
- ② Microphone Luminous ring
- ③ Microphone Rob
- ④ Microphone Status Window
- ⑤ Volume Adjustment Button
- ⑥ Power Switch
- ⑦ Volume Adjustment Button

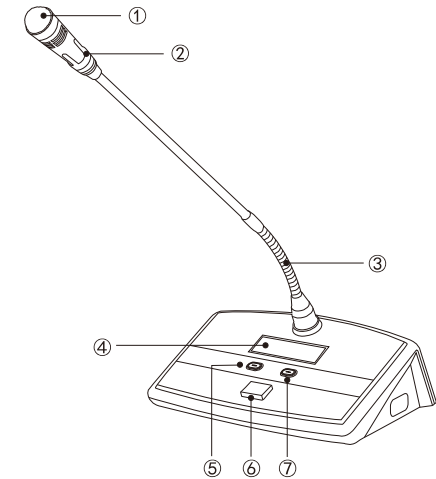

2.Dispaly Instruction

- ① Mute status display
- ② Display AF output specification
- ③ Channel frequency
- ④ Battery level
- ⑤ Microphone status

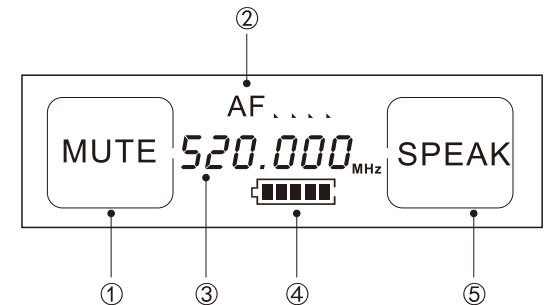

3.Operation Instruction

- 1)Turn on the transmitter by long press ON/OFF button. The same operation to turn off the transmitter.
- 2)Conference transmitter prevents RF interference, especially for mobile phone interference effect is obvious.