



HDMI & VGA to 3GSDI Scaler/Converter

EXT-HDVGA-3G-SC

User Manual



Release A4

Important Safety Instructions

1. Read these instructions.
2. Keep these instructions.
3. Heed all warnings.
4. Follow all instructions.
5. Do not use this product near water.
6. Clean only with a dry cloth.
7. Do not block any ventilation openings. Install in accordance with the manufacturer's instructions.
8. Do not install or place this product near any heat sources such as radiators, heat registers, stoves, or other apparatus (including amplifiers) that produce heat.
9. Do not defeat the safety purpose of the polarized or grounding-type plug. A polarized plug has two blades with one wider than the other. A grounding type plug has two blades and a third grounding prong. The wide blade or the third prong are provided for your safety. If the provided plug does not fit into your outlet, consult an electrician for replacement of the obsolete outlet.
10. Protect the power cord from being walked on or pinched particularly at plugs, convenience receptacles, and the point where they exit from the apparatus.
11. Only use attachments/accessories specified by the manufacturer.
12. To reduce the risk of electric shock and/or damage to this product, never handle or touch this unit or power cord if your hands are wet or damp. Do not expose this product to rain or moisture.
13. Unplug this apparatus during lightning storms or when unused for long periods of time.
14. Refer all servicing to qualified service personnel. Servicing is required when the apparatus has been damaged in any way, such as power-supply cord or plug is damaged, liquid has been spilled or objects have fallen into the apparatus, the apparatus has been exposed to rain or moisture, does not operate normally, or has been dropped.
15. Batteries that may be included with this product and/or accessories should never be exposed to open flame or excessive heat. Always dispose of used batteries according to the instructions.

Warranty Information

Gefen warrants the equipment it manufactures to be free from defects in material and workmanship.

If equipment fails because of such defects and Gefen is notified within two (2) years from the date of shipment, Gefen will, at its option, repair or replace the equipment, provided that the equipment has not been subjected to mechanical, electrical, or other abuse or modifications. Equipment that fails under conditions other than those covered will be repaired at the current price of parts and labor in effect at the time of repair. Such repairs are warranted for ninety (90) days from the day of reshipment to the Buyer.

This warranty is in lieu of all other warranties expressed or implied, including without limitation, any implied warranty or merchantability or fitness for any particular purpose, all of which are expressly disclaimed.

1. Proof of sale may be required in order to claim warranty.
2. Customers outside the US are responsible for shipping charges to and from Gefen.
3. Copper cables are limited to a 30 day warranty and cables must be in their original condition.

The information in this manual has been carefully checked and is believed to be accurate. However, Gefen assumes no responsibility for any inaccuracies that may be contained in this manual. In no event will Gefen be liable for direct, indirect, special, incidental, or consequential damages resulting from any defect or omission in this manual, even if advised of the possibility of such damages. The technical information contained herein regarding the features and specifications is subject to change without notice.

For the latest warranty coverage information, refer to the Warranty and Return Policy under the Support section of the Gefen Web site at www.gefen.com.

Technical Support

(818) 772-9100 (800) 545-6900
8:00 AM to 5:00 PM Monday - Friday, Pacific Time

Fax

(818) 772-9120

Email

support@gefen.com

Web

<http://www.gefen.com>

Mailing Address

Gefen, LLC
c/o Customer Service
20600 Nordhoff St.
Chatsworth, CA 91311

Product Registration

Register your product here: <http://www.gefen.com/kvm/Registry/Registration.jsp>

Operating Notes

- By default, the current input and output resolution will be displayed whenever the HDMI & VGA to 3GSDI Scaler/Converter is disconnected from the source or display or if a change in the video output settings are made. This feature can be disabled through the Display Notify option See [Display Notify \(page 37\)](#).
- Two-channel analog audio, from the **L/R In** port, will be embedded with the VGA signal and output on the **SDI Out** port.
- Always make sure that the HDMI & VGA to 3GSDI Scaler/Converter is running the latest firmware. The Gefen Syner-G™ Software Suite is a free downloadable application from Gefen that provides automatic download and installation of firmware upgrades for this product.

Download the application here: <http://www.gefen.com/synerg/>

HDMI & VGA to 3GSDI Scaler/Converter is a trademark of Gefen, LLC.

© 2015 Gefen, LLC. All Rights Reserved. All trademarks are the property of their respective owners.

Gefen, LLC reserves the right to make changes in the hardware, packaging, and any accompanying documentation without prior written notice.



This product uses UL or CE listed power supplies.

Features

- Converts and scales HDMI and VGA with L/R analog audio to SDI
- Input resolutions up to 1920 x 1200 (WUXGA) and 1080p60 (HDMI only)
- Output resolutions up to 1080p60 (3G-A / 3G-B)
- On-screen display (OSD) menu allows easy set-up and control
- Aspect Ratio Control: Full Screen, Panoramic, Letter/Pillar, Extract/Crop
- Test Pattern Generator for quick system configuration
- Embeds 2-channel analog stereo audio in SDI signal (VGA Input only)
- Up to LPCM 7.1 audio support (HDMI input only)
- Gefen Syner-G™ simplifies in-field firmware updates and advanced EDID management including custom input timings
- USB port for use with Gefen Syner-G™
- Wide power supply operating range (6V to 24V DC)
- Locking power supply connector
- Surface mountable



Packing List

The HDMI & VGA to 3GSDI Scaler/Converter ships with the items listed below. If any of these items are not present in the box when you first open it, immediately contact your dealer or Gefen.

- 1 x HDMI & VGA to 3GSDI Scaler/Converter
- 1 x 6 ft. VGA cable (M-M)
- 1 x 6 ft. HDMI cable (M-M)
- 1 x 6 ft. 3.5mm mini-stereo cable
- 1 x 12V Power Supply
- 1 x Quick-Start Guide

This page left intentionally blank.

1 Getting Started

Introduction.....	2
Installation	4
Connection Instructions.....	4
Sample Wiring Diagram	5

2 Basic Operation

Selecting the Input Source	8
Menu System	9
Displaying the Menu System.....	9
Moving around within the Menu System	10
Output Resolution	13
Output Lock.....	15
Source Select.....	17
Contrast.....	19
Brightness	20
Saturation	21
Hue.....	22
Color Temperature	23
Color Balance.....	24
Edge Enhance.....	25
Sharpness	26
Underscan/Overscan	27
Aspect Ratio.....	28
Horizontal Mirror.....	29
Vertical Mirror	31
Horizontal Shift.....	33
Vertical Shift	34
Phase	35
OSD Timeout	36
Display Notify	37
Input Resolution Information	39
F/W Version	40
Factory Reset.....	41
Test Patterns.....	42
DIP Switch Configuration	44

3 Appendix

Menu System Summary	48
Default Settings	53
USB Interface	54
Installing the Virtual COM Port	54
Updating the Firmware	56
Surface Mounting Instructions	61
Specifications	62
Index	63

This page left intentionally blank.

HDMI & VGA to 3GSDI Scaler/Converter

1

Getting Started

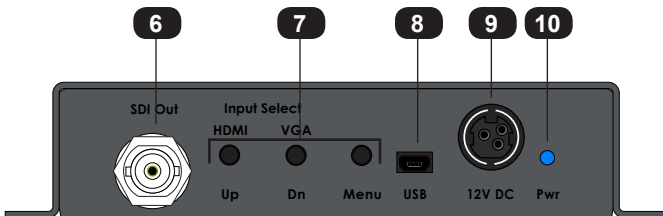
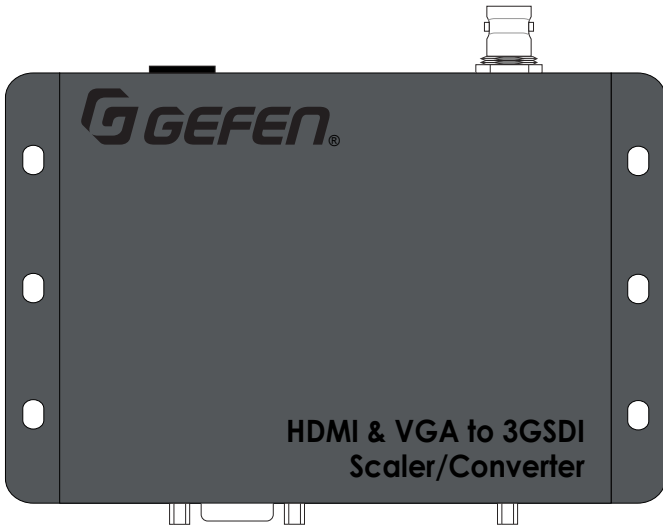
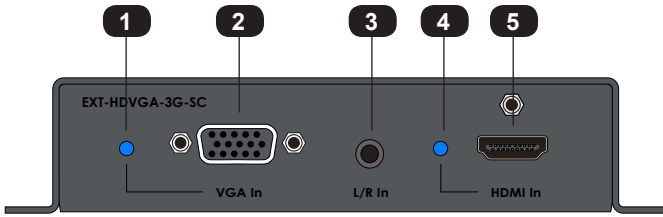

ID	Name	Description
1	VGA In (LED)	This LED indicator will glow bright blue when the VGA input is selected.
2	VGA In	Connect the included VGA cable from source device (e.g. computer) to this port.
3	L/R In	Connect the included 3.5mm mini-stereo cable from this port to the audio output port on the audio source device.
4	HDMI In (LED)	This LED indicator will glow bright blue when the HDMI input is selected.
5	HDMI In	Connect the included HDMI cable from the HD display to this HDMI port.
6	SDI Out	Connect a BNC-type cable from this port to the SDI display.
7	Up/HDMI, Dn/VGA, Menu	These push-buttons are used to change settings within the on-screen menu system. See Menu System (page 9) for more information.
8	USB	This mini-USB port is used for upgrading the firmware. See ## for more information.
9	12V DC	Connect the included 12V DC power supply to this power receptacle.
10	Pwr	Under normal operating conditions, this LED indicator will glow bright blue.

Connection Instructions

▶ Video

1. Connect the included VGA cable from the video source (e.g. computer) to the **VGA In** port on the HDMI & VGA to 3GSDI Scaler/Converter.
2. Connect the included HDMI cable from the source (e.g. DVD player) to the **HDMI In** port on the HDMI & VGA to 3GSDI Scaler/Converter.
3. Connect a BNC-type cable from the **SDI Out** port on the HDMI & VGA to 3GSDI Scaler/Converter to the SDI display.

▶ Audio

4. Connect the included 3.5mm mini-stereo cable from the audio source to the **L/R In** port on the HDMI & VGA to 3G Scaler/Converter.



Information

The L/R In port is used only when the VGA In port is the active input. Refer to [Selecting the Input Source \(page 8\)](#) for information on switching between HDMI and VGA inputs.

▶ USB (optional Syner-G™ software control)

5. Connect a USB-to-mini USB cable from the HDMI & VGA to 3G Scaler/Converter to a computer that is running the Syner-G™ Software Suite. To complete this portion of the installation, see [USB Interface \(page 54\)](#). This connection is *required* for updating the firmware.

▶ Power

6. Connect the included power supply to the 12V DC power receptacle and connect the power cord to an available electrical outlet.

Sample Wiring Diagram

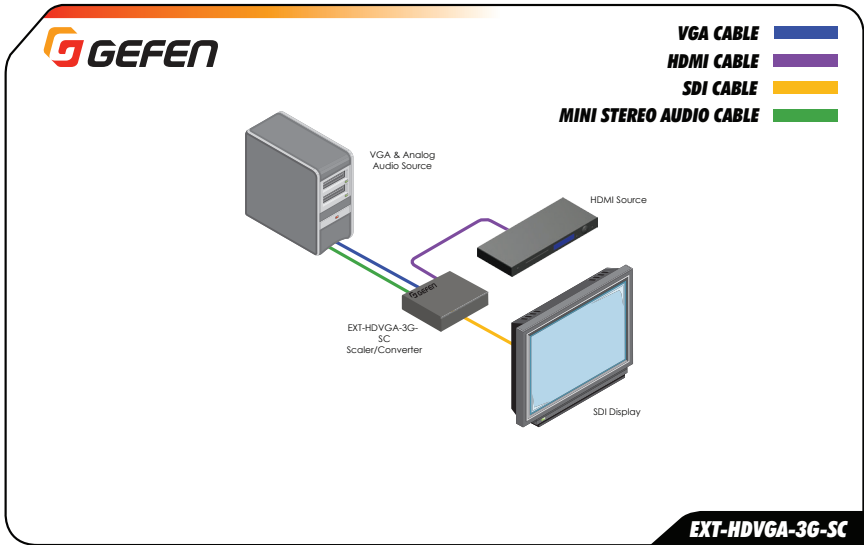

This page left intentionally blank.

HDMI & VGA to 3GSDI Scaler/Converter

2 Basic Operation

Selecting the Input Source

Use the **Input Select** buttons to switch between HDMI and VGA inputs.

- To switch to the HDMI input, press the **HDMI / Up** button:

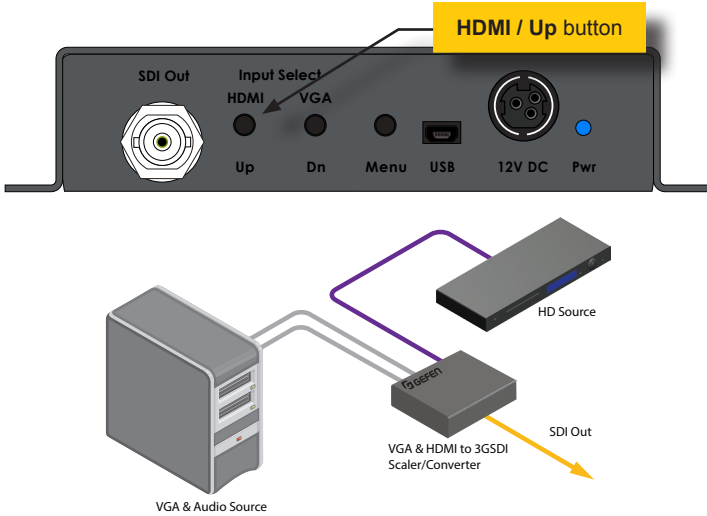

- To switch to the VGA input, press the **VGA / Dn** button:

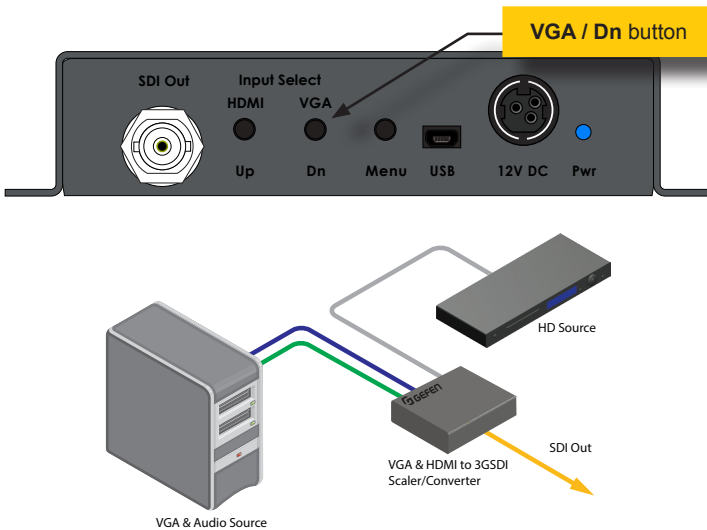

Displaying the Menu System

The HDMI & VGA to 3GSDI Scaler/Converter uses a built-in menu system to manage and control all video features.

1. To display the menu system, press the **Menu** button on the front panel.

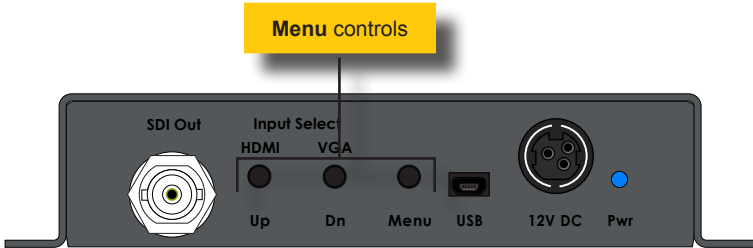

2. The menu system will be displayed in the upper-left corner of the screen, as shown below:

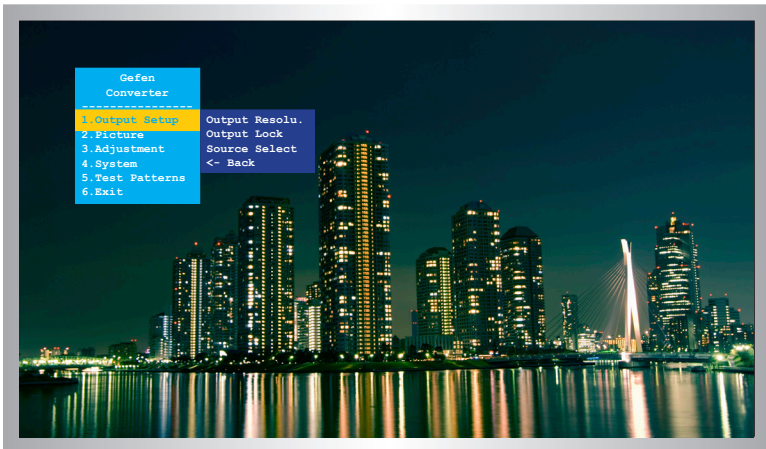

If the menu system is not used within the time interval specified by the OSD Timeout setting, then the menu system will automatically be hidden. By default, the OSD Timeout setting is 5 seconds. See [OSD Timeout \(page 36\)](#) for instructions on setting the OSD Timeout value.

(continued on next page)

Moving around within the Menu System

1. There are six menu items within the *main menu*: **Output Setup**, **Picture**, **Adjustment**, **System**, **Test Patterns**, and **Exit**.
2. The currently selected item within the main menu will always be highlighted in yellow.
3. Each item within the main menu, with the exception of **Exit**, contains a *submenu*. The submenu, for each item in the main menu, is displayed automatically.

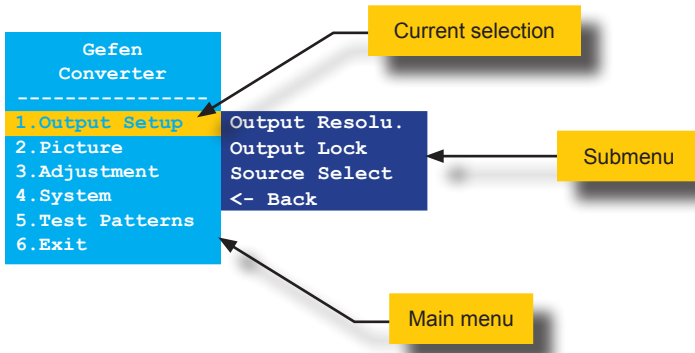

4. Use the **Up** or **Dn** button to highlight the desired item within the main menu.

For example, if we press the **Dn** button three times, the **System** menu item will be highlighted and its submenu will be displayed.

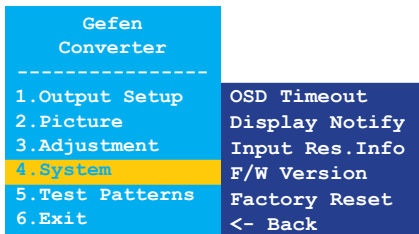

(continued on next page)

- To access the submenu for the highlighted item within the main menu, press the **Menu** button a second time. When a submenu is activated, a green bar is used to indicate the current selection. By default, the top submenu item will always be highlighted once a submenu is activated.

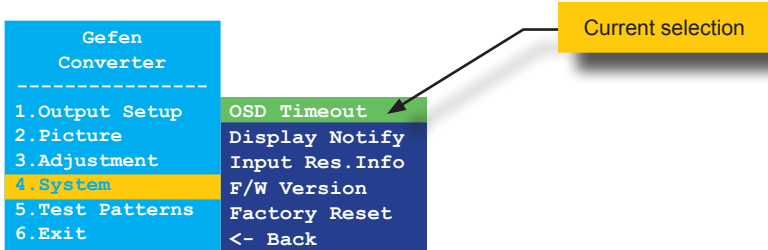

- Use the **Up** or **Dn** button to select the desired option within the submenu.

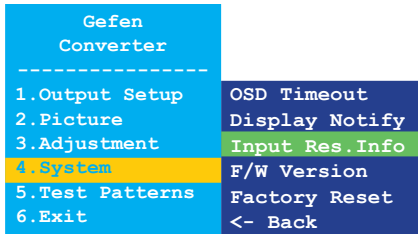

- To select the highlighted submenu item, press the **Menu** button.

For example, if we press the **Menu** button when the **Input Res. Info** option is highlighted, the menu system will be hidden and the following will be displayed:



- Press the **Menu** button to return to the menu system.

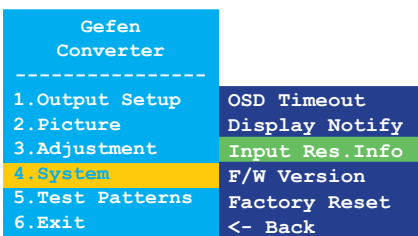

9. To exit the submenu and return to the main menu, use the **Up** or **Dn** button to highlight the **<- Back** option.

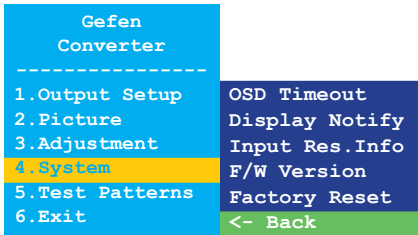

10. Press the **Menu** button to return to the main menu.

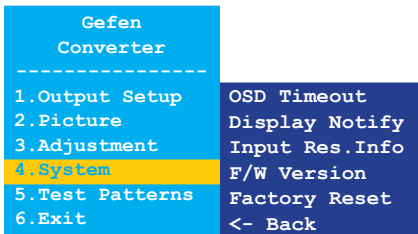

11. To exit the menu system, use the **Up** or **Dn** button to highlight the **Exit** option:



12. Press the **Menu** button to select the **Exit** option.
13. The menu system is now hidden. To display the menu system again, press the **Menu** button.



Information

By default, the menu system will automatically time-out if no action is taken within 5 seconds. To exit the menu system manually (before the time-out period), highlight the **Exit** option then press the **Menu** button.

See OSD Timeout (page 36) for more information.

Output Resolution



Warning

Before changing this setting, make sure that the connected display can support the selected output resolution. If an unsupported resolution is selected, the unit will need to be reset using the DIP switch on the bottom of the unit. See [DIP Switch Configuration \(page 44\)](#) for more information.

1. Press the **Menu** button on the front panel. The **Output Setup** option will be highlighted.
2. Press the **Menu** button to access the **Output Setup** submenu. The **Output Resolu.** option will be highlighted.
3. Press the **Menu** button to select the **Output Resolu.** option.

Gefen Converter -----	
1. Output Setup	Output Resolu.
2. Picture	Output Lock
3. Adjustment	Source Select
4. System	<- Back
5. Test Patterns	
6. Exit	

4. The **Output Resolu.** selection box be displayed:

Output Resolu. ◀ 1080p (HD) 60 ▶

5. Use the **Up** or **Dn** button to select the desired resolution. For a list of available output resolutions that are supported by the HDMI & VGA to 3GSDI Scaler/Converter, see [Menu System Summary \(page 48\)](#).
6. After the desired output resolution is selected, press the **Menu** button to confirm the change.
7. After the output resolution has been changed, the current input and output resolution will be displayed above the **Output Resolu.** selection box:

Input	720p (HD) 60
Output	1080p (HD) 60

(continued on next page)



Information

The input/output resolution information dialog will only be displayed if **Display Notify** is set to On. See **Display Notify** (page 37) for more information.

8. After a few seconds, the input and output resolution information dialog will disappear.
9. The **Output Resolu.** dialog is still displayed:

Output Resolu. ◀ [1080p (HD) 60] ▶

10. Press the **Menu** button to return to the **Output Setup** submenu:

Gefen Converter -----	
1. Output Setup	Output Resolu.
2. Picture	Output Lock
3. Adjustment	Source Select
4. System	<- Back
5. Test Patterns	
6. Exit	

11. Use the **Up** or **Dn** button to select the **<- Back** option.
12. Press the **Menu** button.
13. Use the **Up** or **Dn** button to select the **Exit** option
14. Press the **Menu** button to exit the main menu.

Output Lock



Information

This menu option is available only when the HDMI input is active.

1. Press the **Menu** button on the front panel. The **Output Setup** option will be highlighted.
2. Press the **Menu** button to access the **Output Setup** submenu. The **Output Resolu.** option will be highlighted.
3. Use the **Up** or **Dn** button to highlight the **Output Lock** option.

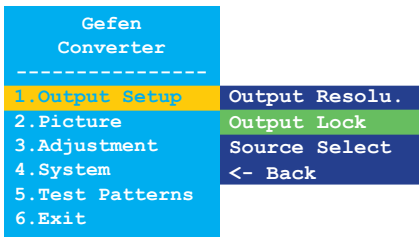

4. Press the **Menu** button to select the **Output Lock** option.
5. The **Output Lock** selection box will be displayed:



6. Use the **Up** or **Dn** button to select either **FreeRun** or **HDMI** mode.
7. After the desired signal lock is selected, press the **Menu** button to confirm the change.
8. The **Output Lock** dialog is still displayed:



(continued on next page)

10. Press the **Menu** button to return to the **Output Setup** submenu:

Gefen Converter -----	
1. Output Setup	Output Resolu.
2. Picture	Output Lock
3. Adjustment	Source Select
4. System	<- Back
5. Test Patterns	
6. Exit	

11. Use the **Up** or **Dn** button to select the **<- Back** option.
12. Press the **Menu** button.
13. Use the **Up** or **Dn** button to select the **Exit** option
14. Press the **Menu** button to exit the main menu.

Source Select

1. Press the **Menu** button on the front panel. The **Output Setup** option will be highlighted.
2. Press the **Menu** button to access the **Output Setup** submenu. The **Output Resolu.** option will be highlighted.
3. Use the **Up** or **Dn** button to highlight the **Source Select** option.

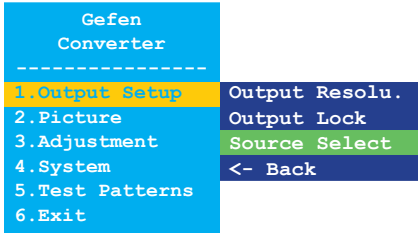

4. Press the **Menu** button to select the **Source Select** option.
5. The **Source Select** dialog box will be displayed:

Source Select ◀ (VGA ▶

Before selecting a new source, make sure that the source is connected to the correct port on the HDMI & VGA to 3GSDI Scaler/Converter.

6. Use the **Up** or **Dn** button to select between **VGA** or **HDMI**.
7. After the source has been selected, press the **Menu** button to confirm the change.
8. The current input and output resolution will be displayed above the current output mode selection.

Input	1280x1024p60
Output	HD (720p) 60



Information

The input/output resolution information dialog will only be displayed if **Display Notify** is set to On. See [Display Notify](#) (page 37) for more information.

(continued on next page)

8. The **Source Select** dialog is still displayed:

Source Select ◀ HDMI ▶

9. Press the **Menu** button to return to the **Output Setup** submenu:

Gefen Converter -----	
1.Output Setup	Output Resolu.
2.Picture	Output Color
3.Adjustment	Output Mode
4.System	<- Back
5.Test Patterns	
6.Exit	

10. Use the **Up** or **Dn** button to select the **<- Back** option.
11. Press the **Menu** button.
12. Use the **Up** or **Dn** button to select the **Exit** option
13. Press the **Menu** button to exit the main menu.

Contrast

1. Press the **Menu** button on the front panel. The **Output Setup** option will be highlighted.
2. Use the **Up** or **Dn** button to highlight the **Picture** option.
3. Press the **Menu** button to access the **Picture** submenu. The **Contrast** option will be highlighted.

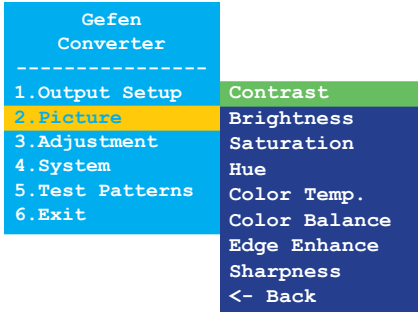

4. Press the **Menu** button to select the **Contrast** option.
5. The **Contrast** selection box will be displayed:



6. Use the **Up** or **Dn** button to set the desired contrast level.
7. Press the **Menu** button to confirm the change and return to the **Picture** submenu.
8. Use the **Up** or **Dn** button to select the **<- Back** option.
9. Press the **Menu** button.
10. Use the **Up** or **Dn** button to select the **Exit** option
11. Press the **Menu** button to exit the main menu.

Brightness

1. Press the **Menu** button on the front panel. The **Output Setup** option will be highlighted.
2. Use the **Up** or **Dn** button to highlight the **Picture** option.
3. Press the **Menu** button to access the **Picture** submenu. The **Contrast** option will be highlighted.
4. Use the **Up** or **Dn** button to highlight the **Brightness** option.

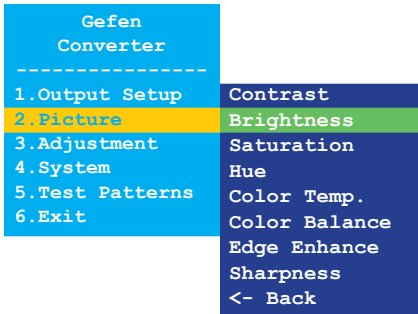

5. Press the **Menu** button to select the **Brightness** option.
6. The **Brightness** selection box will be displayed:



7. Use the **Up** or **Dn** button to set the desired brightness level.
8. Press the **Menu** button to confirm the change and return to **Picture** submenu.
9. Use the **Up** or **Dn** button to select the **<- Back** option.
10. Press the **Menu** button.
11. Use the **Up** or **Dn** button to select the **Exit** option
12. Press the **Menu** button to exit the main menu.

Saturation

1. Press the **Menu** button on the front panel. The **Output Setup** option will be highlighted.
2. Use the **Up** or **Dn** button to highlight the **Picture** option.
3. Press the **Menu** button to access the **Picture** submenu. The **Contrast** option will be highlighted.
4. Use the **Up** or **Dn** button to highlight the **Saturation** option.

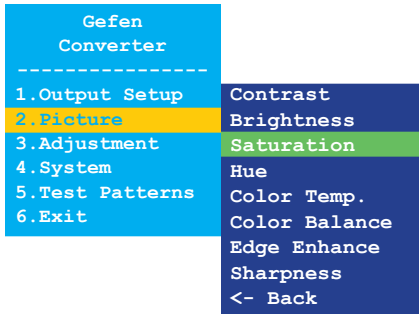

5. Press the **Menu** button to select the **Saturation** option.
6. The **Saturation** selection box will be displayed:



7. Use the **Up** or **Dn** button to set the desired saturation level.
8. Press the **Menu** button to confirm the change and return to the **Picture** submenu.
9. Use the **Up** or **Dn** button to select the **<- Back** option.
10. Press the **Menu** button.
11. Use the **Up** or **Dn** button to select the **Exit** option
12. Press the **Menu** button to exit the main menu.

Hue

1. Press the **Menu** button on the front panel. The **Output Setup** option will be highlighted.
2. Use the **Up** or **Dn** button to highlight the **Picture** option.
3. Press the **Menu** button to access the **Picture** submenu. The **Contrast** option will be highlighted.
4. Use the **Up** or **Dn** button to highlight the **Hue** option.

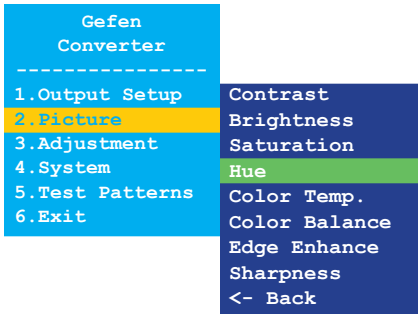

5. Press the **Menu** button to select the **Hue** option.
6. The **Hue** selection box will be displayed:



7. Use the **Up** or **Dn** button to set the desired hue.
8. Press the **Menu** button to confirm the change and return to the **Picture** submenu.
9. Use the **Up** or **Dn** button to select the **<- Back** option.
10. Press the **Menu** button.
11. Use the **Up** or **Dn** button to select the **Exit** option
12. Press the **Menu** button to exit the main menu.

Color Temperature

1. Press the **Menu** button on the front panel. The **Output Setup** option will be highlighted.
2. Use the **Up** or **Dn** button to highlight the **Picture** option.
3. Press the **Menu** button to access the **Picture** submenu. The **Contrast** option will be highlighted.
4. Use the **Up** or **Dn** button to highlight the **Color Temp.** option.

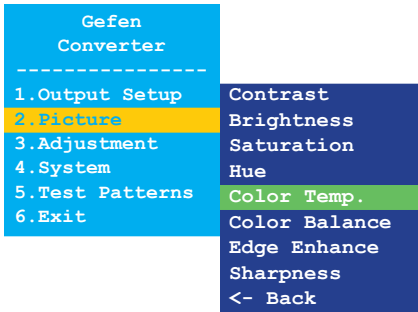

5. Press the **Menu** button to select the **Color Temp.** option.
6. The **Color Temp.** selection box will be displayed:



7. Use the **Up** or **Dn** button to select between **Neutral**, **Cool**, or **Warm**.
8. Press the **Menu** button to confirm the change and return to the **Picture** submenu.
9. Use the **Up** or **Dn** button to select the **<- Back** option.
10. Press the **Menu** button.
11. Use the **Up** or **Dn** button to select the **Exit** option
12. Press the **Menu** button to exit the main menu.

Color Balance

1. Press the **Menu** button on the front panel. The **Output Setup** option will be highlighted.
2. Use the **Up** or **Dn** button to highlight the **Picture** option.
3. Press the **Menu** button to access the **Picture** submenu. The **Contrast** option will be highlighted.
4. Use the **Up** or **Dn** button to highlight the **Color Balance** option.

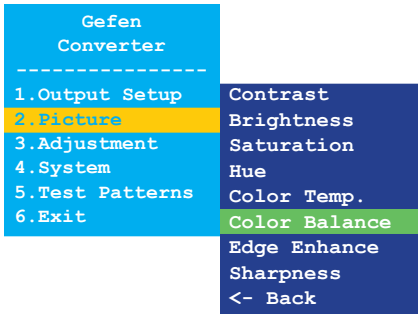

5. Press the **Menu** button to select the **Color Balance** option.
6. The **Color Balance** selection box will be displayed:

Color Balance [Red Ch. 50]

7. Use the **Up** or **Dn** button to switch between **Red Ch.**, **Blue Ch.**, and **Blue Ch.**
8. Press the **Menu** button to select the color channel to adjust.



9. Use the **Up** or **Dn** button to set the desired color balance setting.
10. Press the **Menu** button to confirm the change and return to the **Picture** submenu.
11. Use the **Up** or **Dn** button to select the **<- Back** option.
12. Press the **Menu** button.
13. Use the **Up** or **Dn** button to select the **Exit** option
14. Press the **Menu** button to exit the main menu.

Edge Enhance

1. Press the **Menu** button on the front panel. The **Output Setup** option will be highlighted.
2. Use the **Up** or **Dn** button to highlight the **Picture** option.
3. Press the **Menu** button to access the **Picture** submenu. The **Contrast** option will be highlighted.
4. Use the **Up** or **Dn** button to highlight the **Edge Enhance** option.

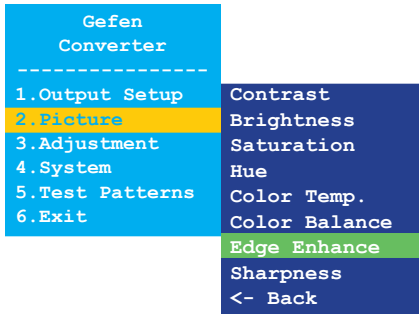

5. Press the **Menu** button to select the **Edge Enhance** option.
6. The **Edge Enhance** selection box will be displayed:

Edge Enhance ◀ [User] ▶

7. Use the **Up** or **Dn** button to select between **User**, **Off**, **Mid**, or **Max**.
8. Press the **Menu** button to confirm the change and return to the **Picture** submenu.
9. Use the **Up** or **Dn** button to select the **<- Back** option.
10. Press the **Menu** button.
11. Use the **Up** or **Dn** button to select the **Exit** option
12. Press the **Menu** button to exit the main menu.

Sharpness

1. Press the **Menu** button on the front panel. The **Output Setup** option will be highlighted.
2. Use the **Up** or **Dn** button to highlight the **Picture** option.
3. Press the **Menu** button to access the **Picture** submenu. The **Contrast** option will be highlighted.
4. Use the **Up** or **Dn** button to highlight the **Sharpness** option.

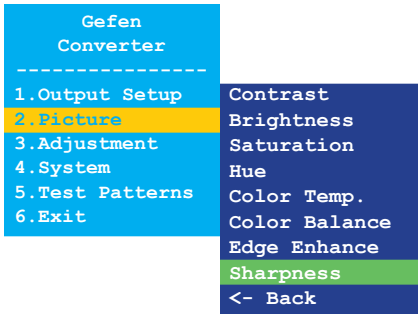

5. Press the **Menu** button to select the **Sharpness** option.
6. The **Sharpness** selection box will be displayed:



7. Use the **Up** or **Dn** button to set the sharpness level. Larger values increase the sharpness of the image.
8. Press the **Menu** button to confirm the change and return to the **Picture** submenu.
9. Use the **Up** or **Dn** button to select the **<- Back** option.
10. Press the **Menu** button.
11. Use the **Up** or **Dn** button to select the **Exit** option
12. Press the **Menu** button to exit the main menu.

Underscan/Overscan

1. Press the **Menu** button on the front panel. The **Output Setup** option will be highlighted.
2. Use the **Up** or **Dn** button to highlight the **Adjustment** option.
3. Press the **Menu** button to access the **Adjustment** submenu. The **Under/Over Scan** option will be highlighted.

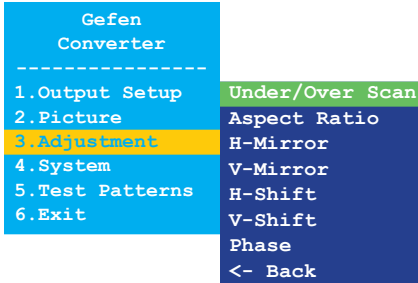

4. Press the **Menu** button to select the **Under/Over Scan** option.
5. The **Under/Over Scan** selection box will be displayed:



6. Use the **Up** or **Dn** button to set the amount of overscan or underscan. Negative values increase the amount of *underscan*. Positive values increase the amount of *overscan*.
7. Press the **Menu** button to confirm the change and return to the **Adjustment** submenu.
8. Use the **Up** or **Dn** button to select the **<- Back** option.
9. Press the **Menu** button.
10. Use the **Up** or **Dn** button to select the **Exit** option
11. Press the **Menu** button to exit the main menu.

Aspect Ratio

1. Press the **Menu** button on the front panel. The **Output Setup** option will be highlighted.
2. Use the **Up** or **Dn** button to highlight the **Adjustment** option.
3. Press the **Menu** button to access the **Adjustment** submenu. The **Under/Over Scan** option will be highlighted.
4. Use the **Up** or **Dn** button to highlight the **Aspect Ratio** option.

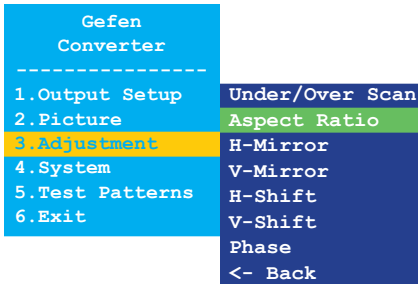

5. Press the **Menu** button to select the **Aspect Ratio** option.
6. The **Aspect Ratio** selection box will be displayed:

Aspect Ratio ◀ [Source] ▶

7. Use the **Up** or **Dn** button to select between **Source**, **16:9**, **4:3**, or **Stretch**.
8. Press the **Menu** button to confirm the change and return to the **Adjustment** submenu.
9. Use the **Up** or **Dn** button to select the **<- Back** option.
10. Press the **Menu** button.
11. Use the **Up** or **Dn** button to select the **Exit** option.
12. Press the **Menu** button to exit the main menu.

Horizontal Mirror

1. Press the **Menu** button on the front panel. The **Output Setup** option will be highlighted.
2. Use the **Up** or **Dn** button to highlight the **Adjustment** option.
3. Press the **Menu** button to access the **Adjustment** submenu. The **Under/Over Scan** option will be highlighted.
4. Use the **Up** or **Dn** button to highlight the **H-Mirror** option.

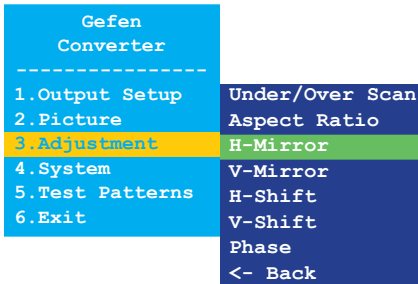

5. Press the **Menu** button to select the **H-Mirror** option.
6. The **H-Mirror** selection box will be displayed:

H-Mirror < [Off] >

7. Use the **Up** or **Dn** button to toggle between **On** and **Off**. When the **H-Mirror** option is set to **On**, then the picture will be flipped horizontally (about the Y-axis).



(continued on next page)

8. Press the **Menu** button to confirm the change and return to the **Adjustment** submenu.
9. Use the **Up** or **Dn** button to select the **<- Back** option.
10. Press the **Menu** button.
11. Use the **Up** or **Dn** button to select the **Exit** option
12. Press the **Menu** button to exit the main menu.

Vertical Mirror

1. Press the **Menu** button on the front panel. The **Output Setup** option will be highlighted.
2. Use the **Up** or **Dn** button to highlight the **Adjustment** option.
3. Press the **Menu** button to access the **Adjustment** submenu. The **Under/Over Scan** option will be highlighted.
4. Use the **Up** or **Dn** button to highlight the **V-Mirror** option.

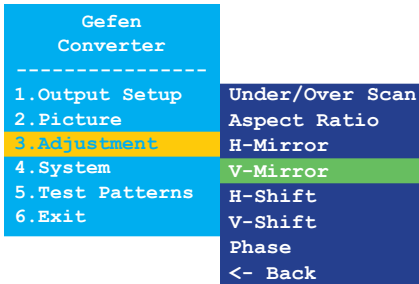

5. Press the **Menu** button to select the **V-Mirror** option.
6. The **V-Mirror** selection box will be displayed:

V-Mirror < [Off] >

7. Use the **Up** or **Dn** button to toggle between **On** and **Off**. When the **V-Mirror** option is set to **On**, then the picture will be flipped vertically (about the X-axis).



(continued on next page)

8. Press the **Menu** button to confirm the change and return to the **Adjustment** submenu.
9. Use the **Up** or **Dn** button to select the **<- Back** option.
10. Press the **Menu** button.
11. Use the **Up** or **Dn** button to select the **Exit** option
12. Press the **Menu** button to exit the main menu.

Horizontal Shift

1. Press the **Menu** button on the front panel. The **Output Setup** option will be highlighted.
2. Use the **Up** or **Dn** button to highlight the **Adjustment** option.
3. Press the **Menu** button to access the **Adjustment** submenu. The **Under/Over Scan** option will be highlighted.
4. Use the **Up** or **Dn** button to highlight the **H-Shift** option.

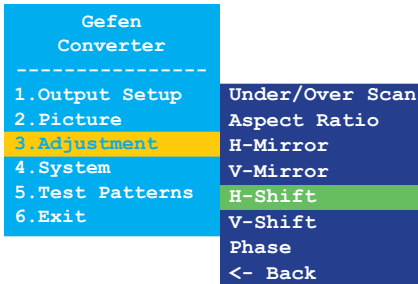

5. Press the **Menu** button to select the **H-Shift** option.
6. The **H-Shift** selection box will be displayed:



7. Use the **Up** or **Dn** button to shift the picture to the left or to the right. Negative values, move the image to the left. Positive values move the image to the right.
8. Press the **Menu** button to confirm the change and return to the **Adjustment** submenu.
9. Use the **Up** or **Dn** button to select the **<- Back** option.
10. Press the **Menu** button.
11. Use the **Up** or **Dn** button to select the **Exit** option
12. Press the **Menu** button to exit the main menu.

Vertical Shift

1. Press the **Menu** button on the front panel. The **Output Setup** option will be highlighted.
2. Use the **Up** or **Dn** button to highlight the **Adjustment** option.
3. Press the **Menu** button to access the **Adjustment** submenu. The **Under/Over Scan** option will be highlighted.
4. Use the **Up** or **Dn** button to highlight the **V-Shift** option.

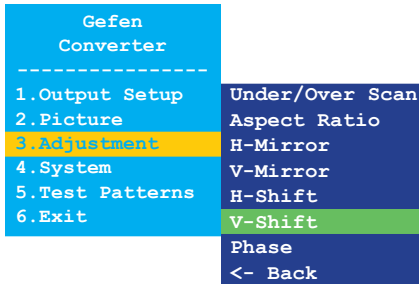

5. Press the **Menu** button to select the **V-Shift** option.
6. The **V-Shift** selection box will be displayed:



7. Use the **Up** or **Dn** button to shift the picture up or down. Negative values, move the image upwards. Positive values move the image downwards.
8. Press the **Menu** button to confirm the change and return to the **Adjustment** submenu.
9. Use the **Up** or **Dn** button to select the **<- Back** option.
10. Press the **Menu** button.
11. Use the **Up** or **Dn** button to select the **Exit** option
12. Press the **Menu** button to exit the main menu.

Phase

1. Press the **Menu** button on the front panel. The **Output Setup** option will be highlighted.
2. Use the **Up** or **Dn** button to highlight the **Adjustment** option.
3. Press the **Menu** button to access the **Adjustment** submenu. The **Under/Over Scan** option will be highlighted.
4. Use the **Up** or **Dn** button to highlight the **Phase** option.

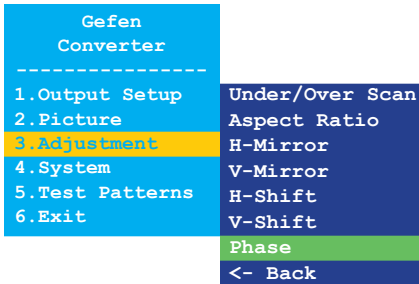

5. Press the **Menu** button to select the **Phase** option.
6. The **Phase** selection box will be displayed:



7. Use the **Up** or **Dn** button to adjust the phase.
8. Press the **Menu** button to confirm the change and return to the **Adjustment** submenu.
9. Use the **Up** or **Dn** button to select the **<- Back** option.
10. Press the **Menu** button.
11. Use the **Up** or **Dn** button to select the **Exit** option
12. Press the **Menu** button to exit the main menu.

OSD Timeout

1. Press the **Menu** button on the front panel. The **Output Setup** option will be highlighted.
2. Use the **Up** or **Dn** button to highlight the **System** option.
3. Press the **Menu** button to access the **System** submenu. The **OSD Timeout** option will be highlighted.

Gefen Converter	

1.Output Setup	OSD Timeout
2.Picture	Display Notify
3.Adjustment	Input Res.Info
4.System	F/W Version
5.Test Patterns	Factory Reset
6.Exit	<- Back

4. Press the **Menu** button to select the **OSD Timeout** option.
5. The **OSD Timeout** selection box will be displayed:

OSD Timeout ◀ 5sec ▶

6. Use the **Up** or **Dn** button to set the OSD timeout to **Off** or from any time interval between 5 and 60 seconds, inclusive. The default setting is 5 seconds.
7. Press the **Menu** button to confirm the change and return to the **System** submenu.
8. Use the **Up** or **Dn** button to select the **<- Back** option.
9. Press the **Menu** button.
10. Use the **Up** or **Dn** button to select the **Exit** option
11. Press the **Menu** button to exit the main menu.

Display Notify

1. Press the **Menu** button on the front panel. The **Output Setup** option will be highlighted.
2. Use the **Up** or **Dn** button to highlight the **System** option.
3. Press the **Menu** button to access the **System** submenu. The **OSD Timeout** option will be highlighted.
4. Use the **Up** or **Dn** button to highlight the **Display Notify** option.

Gefen Converter	

1.Output Setup	OSD Timeout
2.Picture	Display Notify
3.Adjustment	Input Res.Info
4.System	F/W Version
5.Test Patterns	Factory Reset
6.Exit	<- Back

5. Press the **Menu** button to select the **Display Notify** option.
6. The **Display Notify** selection box will be displayed:

Display Notify ◀ [On] ▶

7. Use the **Up** or **Dn** button to toggle between **On** and **Off**. When **Display Notify** is set to **On**, then the input/output resolution information dialog will be displayed, momentarily, whenever the HDMI & VGA to 3GSDI Scaler/Converter is disconnected from the source or display:

Input	1600x1200p60
Output	640x480p60

In addition, the following operations also trigger the input/output resolution information dialog: [Output Resolution \(page 13\)](#), [Output Lock \(page 15\)](#), or [Output Mode \(page 37\)](#). When set to **Off**, the input/output resolution information dialog is never displayed.

(continued on next page)

8. Press the **Menu** button to confirm the change and return to the **System** submenu.
9. Use the **Up** or **Dn** button to select the **<- Back** option.
10. Press the **Menu** button.
11. Use the **Up** or **Dn** button to select the **Exit** option
12. Press the **Menu** button to exit the main menu.

Input Resolution Information

1. Press the **Menu** button on the front panel. The **Output Setup** option will be highlighted.
2. Use the **Up** or **Dn** button to highlight the **System** option.
3. Press the **Menu** button to access the **System** submenu. The **OSD Timeout** option will be highlighted.
4. Use the **Up** or **Dn** button to highlight the **Input Res. Info** option.

Gefen Converter -----	
1.Output Setup	OSD Timeout
2.Picture	Display Notify
3.Adjustment	Input Res.Info
4.System	F/W Version
5.Test Patterns	Factory Reset
6.Exit	<- Back

5. Press the **Menu** button to select the **Input Res. Info** option.
6. The current input resolution will be displayed in the **Input Res. Info** box.

Input Res.Info ◀ 1600x1200p60 ▶

7. Press the **Menu** button to return to the **System** submenu.
8. Use the **Up** or **Dn** button to select the **<- Back** option.
9. Press the **Menu** button.
10. Use the **Up** or **Dn** button to select the **Exit** option
11. Press the **Menu** button to exit the main menu.

F/W Version

1. Press the **Menu** button on the front panel. The **Output Setup** option will be highlighted.
2. Use the **Up** or **Dn** button to highlight the **System** option.
3. Press the **Menu** button to access the **System** submenu. The **OSD Timeout** option will be highlighted.
4. Use the **Up** or **Dn** button to highlight the **F/W Version** option.

Gefen Converter	

1.Output Setup	OSD Timeout
2.Picture	Display Notify
3.Adjustment	Input Res.Info
4.System	F/W Version
5.Test Patterns	Factory Reset
6.Exit	<- Back

5. Press the **Menu** button to select the **F/W Version** option.
6. The current version of firmware will be displayed in the **F/W Version** box.

F/W Version ◀ V1.013 ▶

7. Press the **Menu** button to return to the **System** submenu.
8. Use the **Up** or **Dn** button to select the **<- Back** option.
9. Press the **Menu** button.
10. Use the **Up** or **Dn** button to select the **Exit** option
11. Press the **Menu** button to exit the main menu.

Factory Reset

1. Press the **Menu** button on the front panel. The **Output Setup** option will be highlighted.
2. Use the **Up** or **Dn** button to highlight the **System** option.
3. Press the **Menu** button to access the **System** submenu. The **OSD Timeout** option will be highlighted.
4. Use the **Up** or **Dn** button to highlight the **Factory Reset** option.

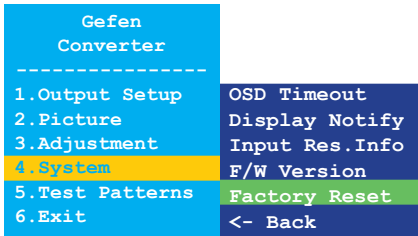

5. Press the **Menu** button to select the **Factory Reset** option.
6. The **Factory Reset** selection box will be displayed.



7. Use the **Up** or **Dn** button to toggle between **No** and **Yes**.
 - ▶ If **Yes** is selected, then the HDMI & VGA to 3GSDI Scaler/Converter will reset to factory-default settings and will automatically reboot.
 - ▶ If **No** is selected, then the HDMI & VGA to 3GSDI Scaler/Converter will return to the **System** submenu.
 - a. Use the **Up** or **Dn** button to select the **<- Back** option.
 - b. Press the **Menu** button.
 - c. Use the **Up** or **Dn** button to select the **Exit** option.
 - d. Press the **Menu** button to exit the main menu.

Test Patterns

1. Press the **Menu** button on the front panel. The **Output Setup** option will be highlighted.
2. Use the **Up** or **Dn** button to highlight the **Test Patterns** option.
3. Press the **Menu** button to access the **Test Patterns** submenu. The **White** option will be highlighted.

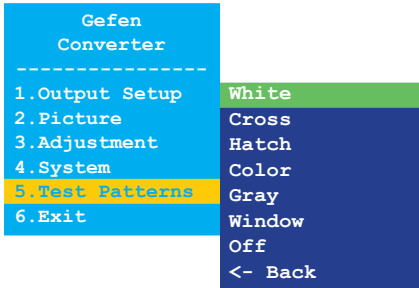

4. Use the **Up** or **Dn** button to highlight the desired test pattern.
5. Press the **Menu** button to select the highlighted test pattern.

White

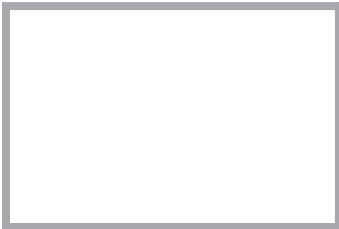

Cross

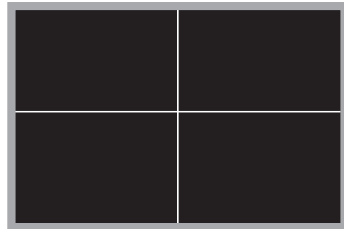

Hatch

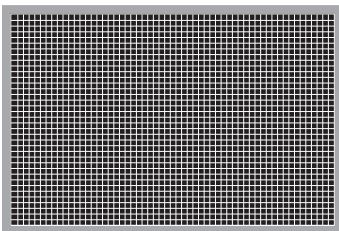

Color



(continued on next page)

Gray

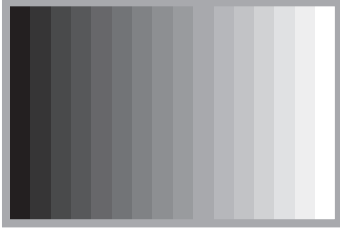

Window

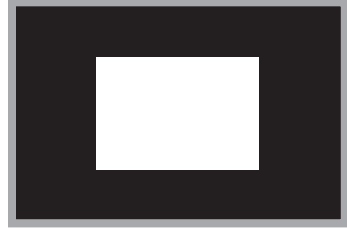



6. Press the **Menu** button to return to the **Test Patterns** submenu and select a different pattern.
7. To disable the pattern and view the source image, select **Off** from the **Test Patterns** submenu.

DIP Switch Configuration

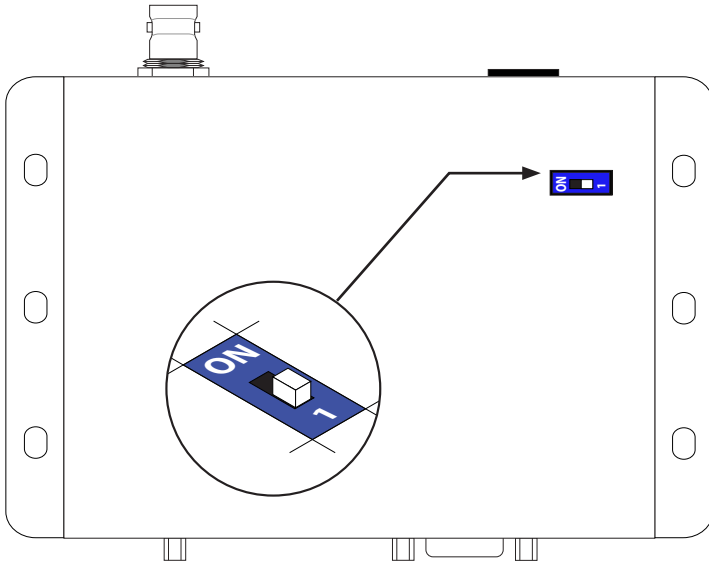
On the bottom panel of the HDMI & VGA to 3GSDI Scaler/Converter is a single DIP switch. Remove the piece of colored tape to reveal the DIP switch bank.



By default, the DIP switch is in the OFF (1) position. The DIP switch should remain in this position during normal operation.

DIP Switch	Description	
1	Factory reset	
	Normal Operation	

This page left intentionally blank.

This page left intentionally blank.

HDMI & VGA to 3GSDI Scaler/Converter

3

Appendix

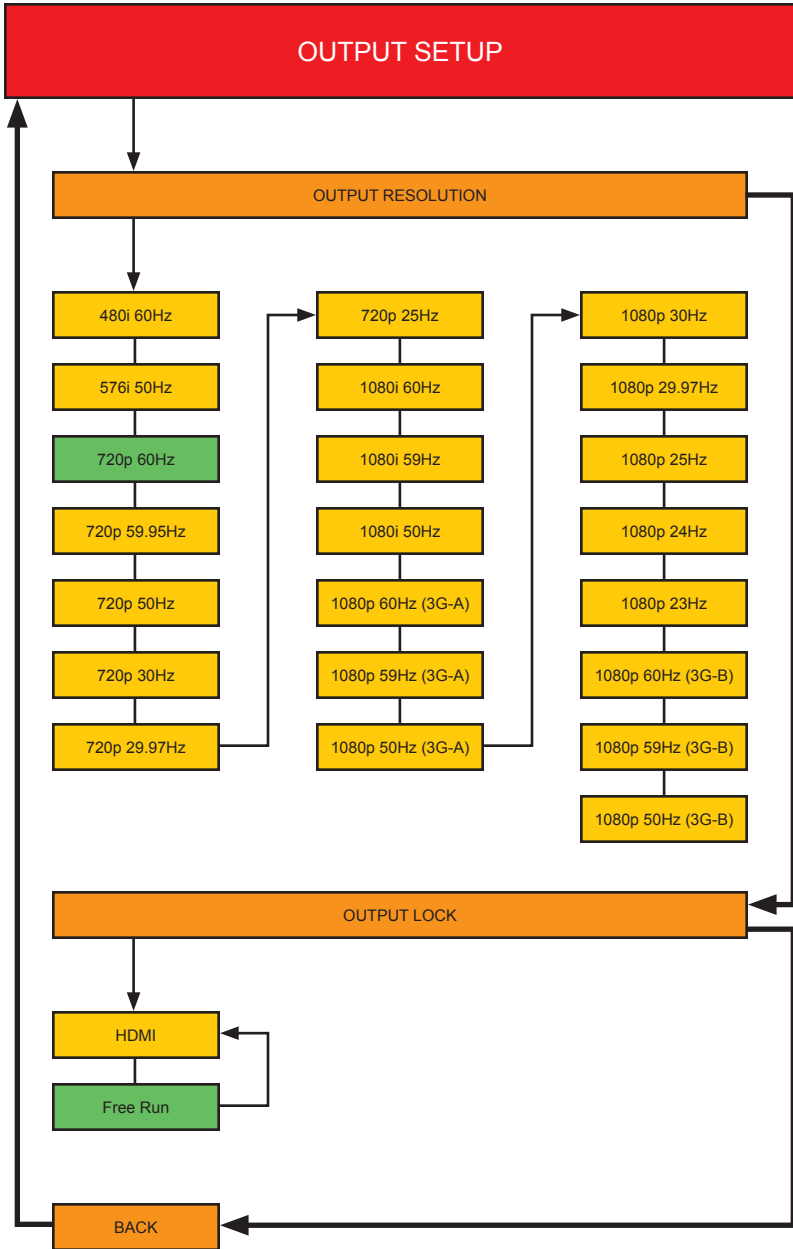

Boxes in green indicate the default setting.
The Output Lock menu is only available when using the HDMI input.

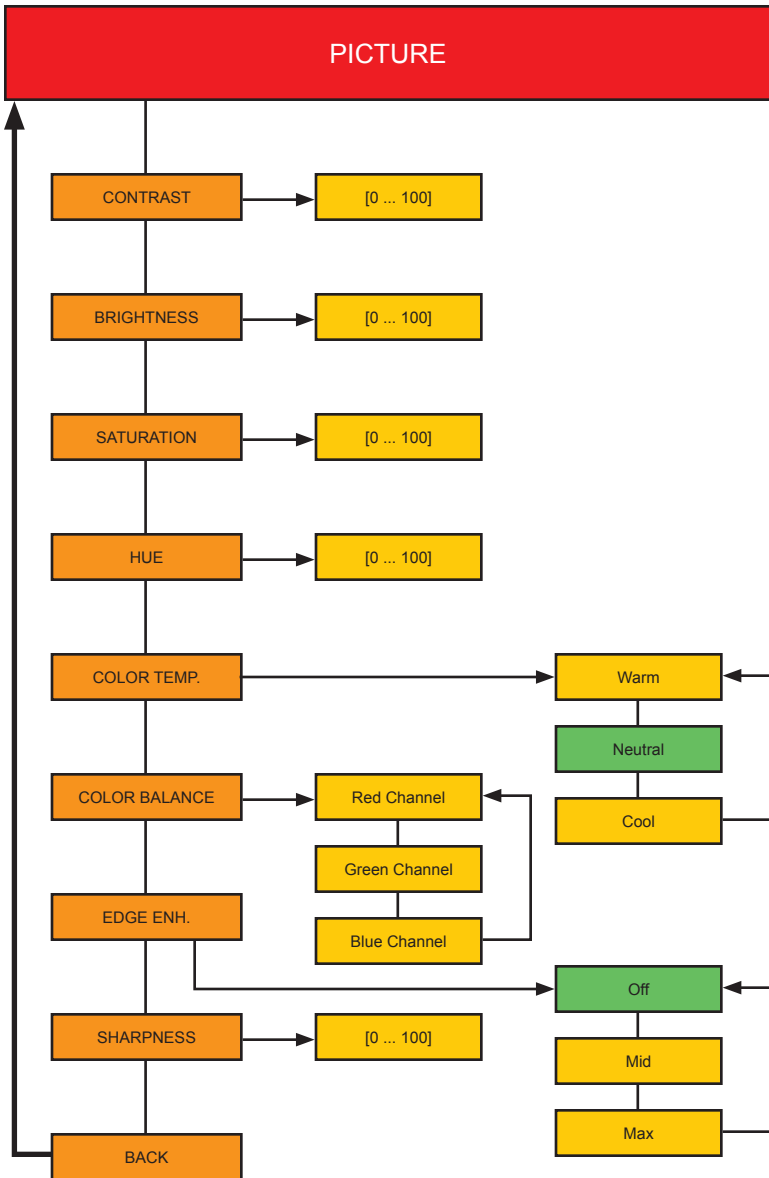

Boxes in green indicate the default setting.

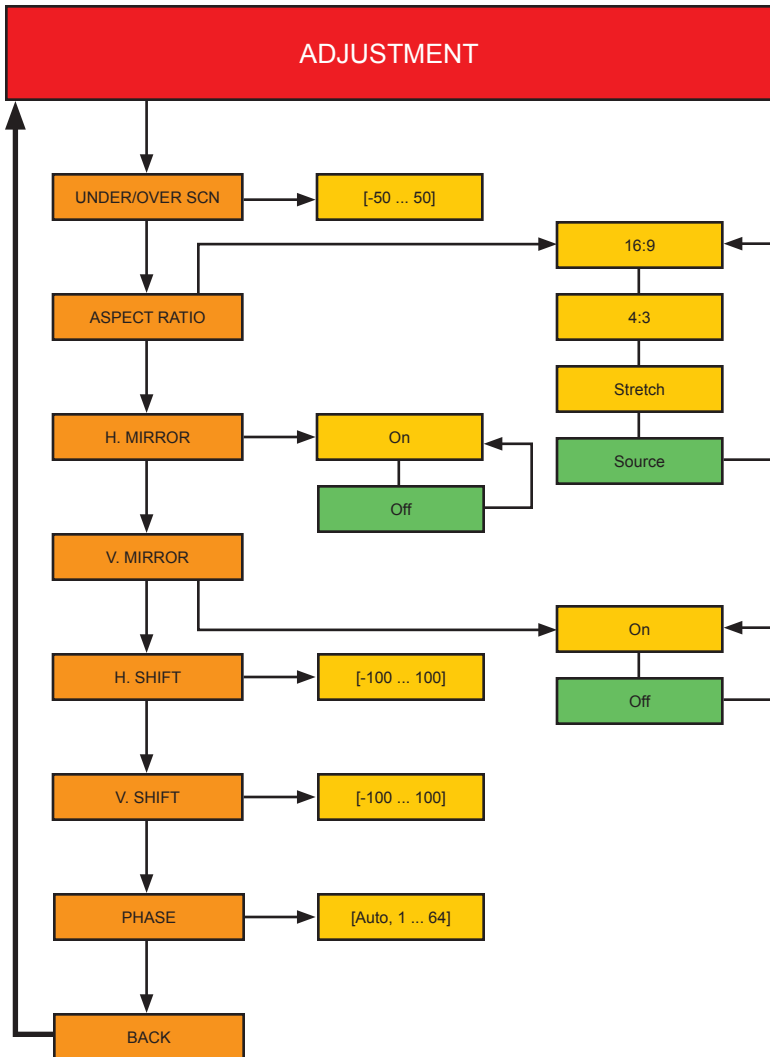

Boxes in green indicate the default setting.

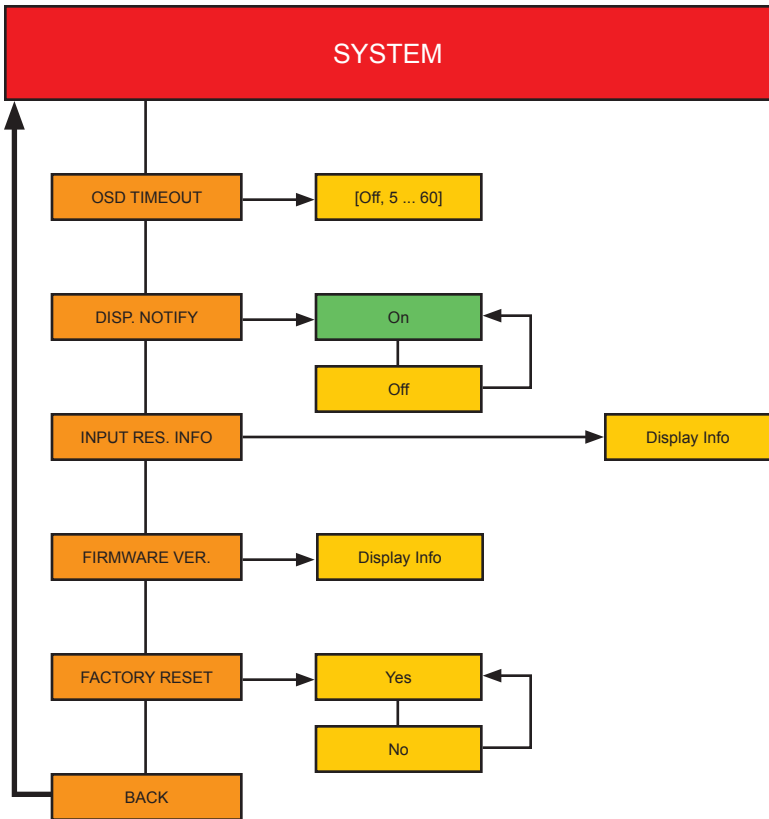

Boxes in green indicate the default setting.

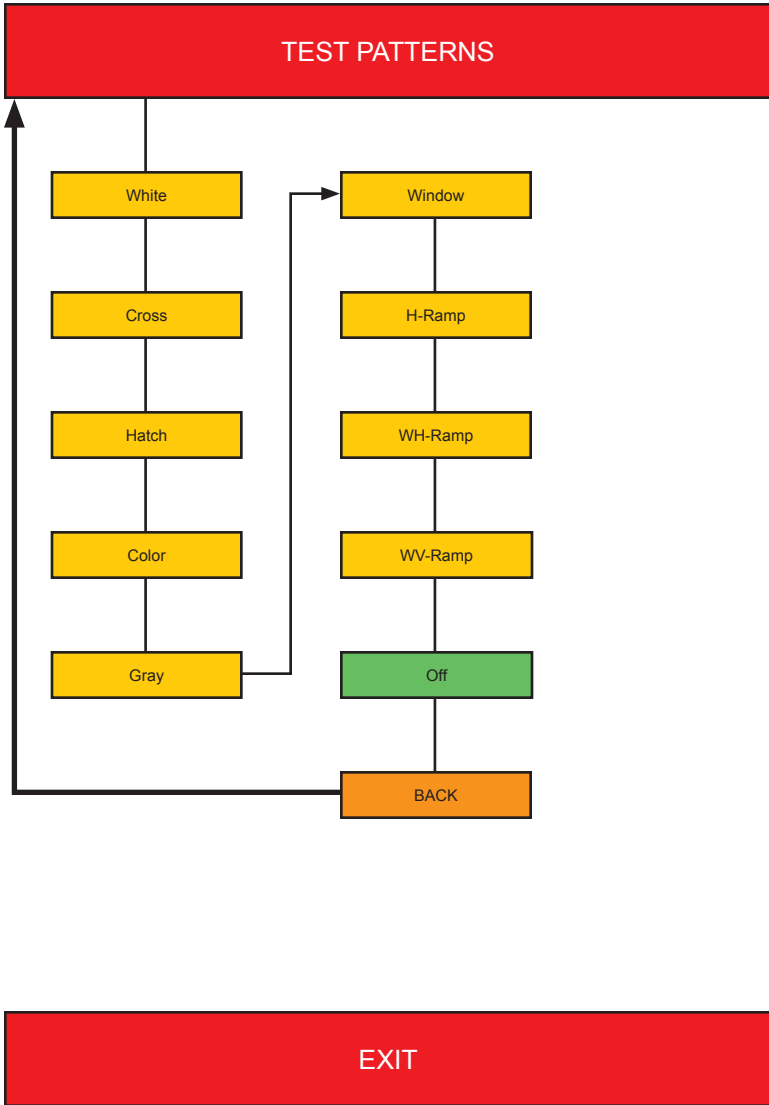

Setting	Value
Aspect Ratio	Source
Brightness	50
Color Balance (Blue Channel)	50
Color Balance (Green Channel)	50
Color Balance (Red Channel)	50
Color Temperature	Neutral
Contrast	50
Display Notifications	On
Edge Enhancement	Off
Horizontal Mirror	Off
Horizontal Shift	Off
Hue	50
OSD Timeout	5 seconds
Output Lock	Free Run
Output Resolution	Auto-Detect
Phase	Auto
Saturation	50
Sharpness	0
Test Patterns	Off
Under/Over Scan	Off
Vertical Mirror	Off
Vertical Shift	Off

Installing the Virtual COM Port

In order to control the HDMI & VGA to 3GSDI Scaler/Converter using the Syner-G™ Software Suite, a virtual COM port must be installed on the computer that is connected to the HDMI & VGA to 3GSDI Scaler/Converter.

1. Install the Gefen Syner-G™ Software Suite. This software is available under the **Support > Downloads** section of the Gefen website.
2. Connect a mini-USB-to-USB cable (not included) from the **USB** port on the HDMI & VGA to 3GSDI Scaler/Converter to an available USB port on the host computer.
3. From the Windows Desktop, click the **Start** button, select **Computer**, then right-click on **Manage**.

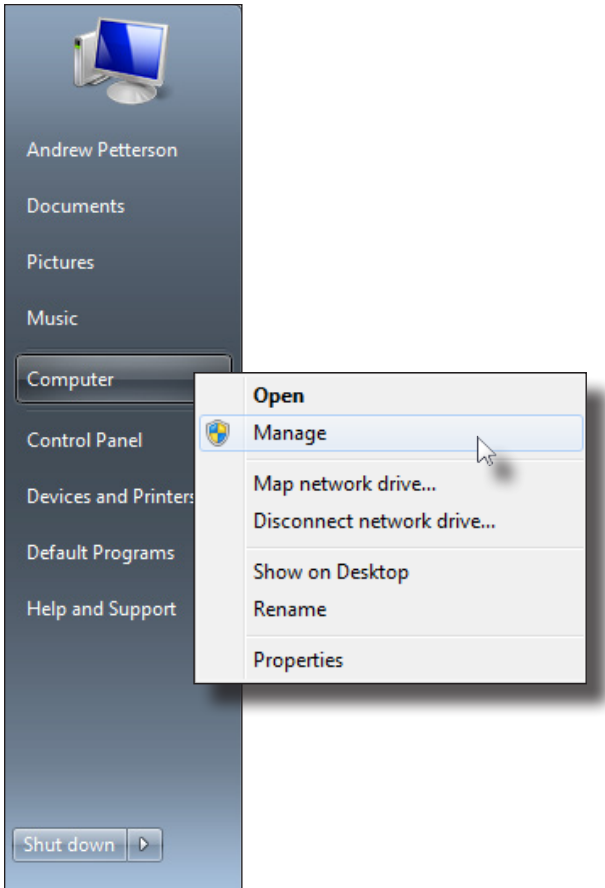

6. The **Computer Management** window will open.
7. In the left window pane, under **System Tools**, click **Device Manager**.
8. In the right window pane, locate **Ports (COM & LPT)**.
The device **EXT-HDVGA-3G-SC** will be displayed along with the COM port.

Use this COM port when configuring the terminal program (e.g. Hyperterminal).

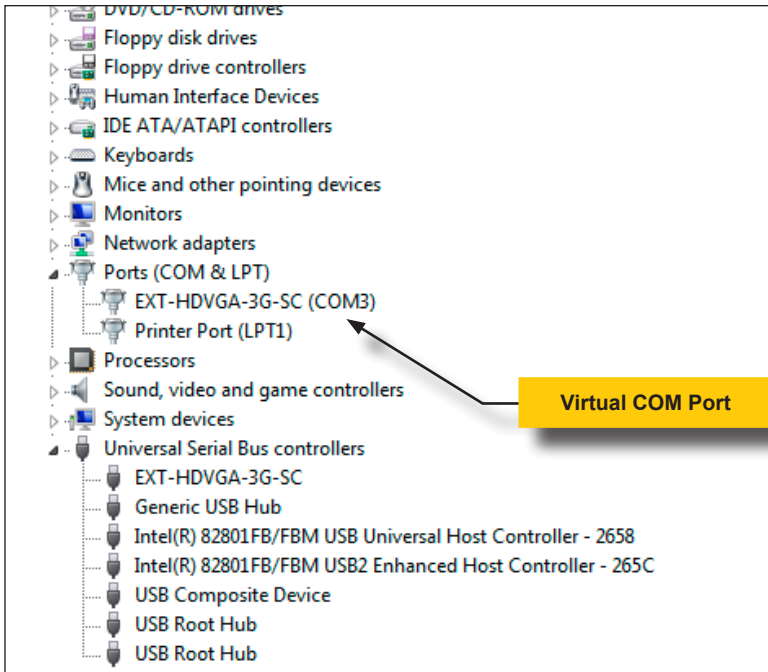

9. Set the terminal program to the following:

Description	Setting
Baud rate	19200
Data bits	8
Parity	None
Stop bits	1
Hardware flow control	None

The Syner-G™ Software Suite provides an easy way to perform firmware updates. Before launching Syner-G™, make sure that a USB cable is connected between the product and the computer that is running the Syner-G™ software. Refer to the Syner-G™ Software Suite User Manual for more information on using other features with this product.

1. Launch the Syner-G™ Software Suite from the Start Menu or using the shortcut from the Windows Desktop.



2. Click the **Manage a Product** button.

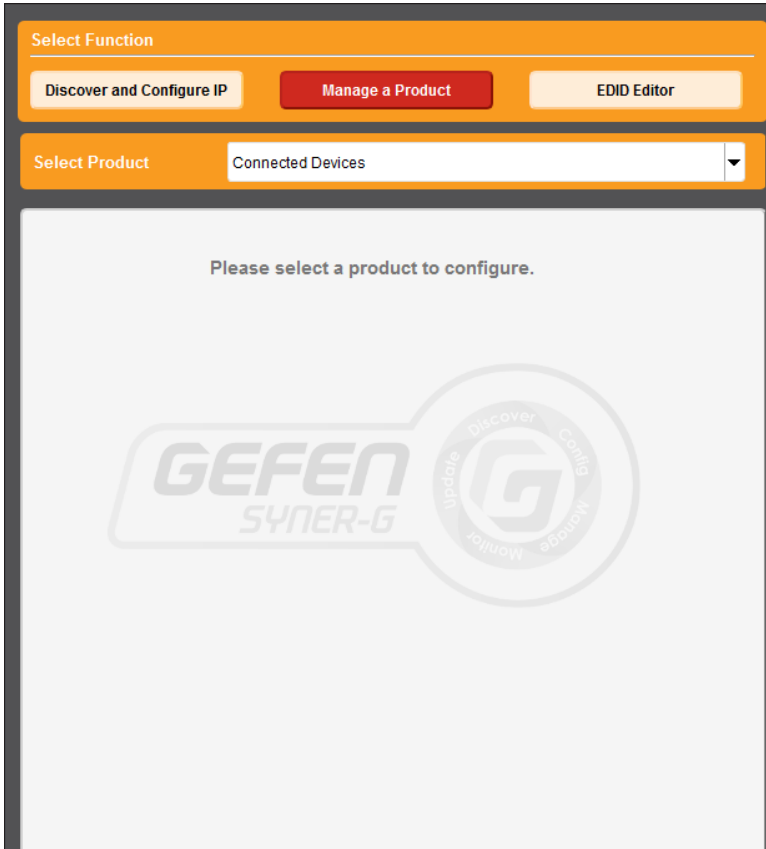

3. Select the product from the **Select your product** drop-down list.



If the product is not detected by Syner-G™, then the product will not be listed in bold type, within the **Select your product** drop-down list. Verify the following:

- ▶ The HDMI & VGA to 3GSDI Scaler/Converter is connected to the computer that is running the Syner-G™ Software Suite, using a USB-to-Mini USB cable.
- ▶ Make sure that the virtual COM port is installed and functioning correctly under Control Panel. See [Installing the Virtual COM Port \(page 54\)](#) for more information.

4. Click the arrow button next to the **Timings** tab until the **Update** tab is displayed.

The screenshot shows the 'Timings' tab selected in the EDID Editor. The interface includes a 'Select Function' bar with 'Discover and Configure IP', 'Manage a Product', and 'EDID Editor' buttons. Below is a 'Select Product' dropdown menu set to 'HDMI/VGA to 3GSDI Scaler, COM9'. A navigation bar contains tabs for 'Output', 'Picture', 'Adjust', 'System', 'Test Patterns', and 'Timings'. The 'Timings' tab is active, displaying a grid of output resolution options. The 'Output Resolution' section shows 'HD (720p) 60Hz' selected, with a 'Refresh' button. Other options include SD (480i) 60Hz, SD (576i) 50Hz, HD (720p) 59Hz, HD (720p) 50Hz, 3G-A (1080p) 60Hz, 3G-A (1080p) 59Hz, 3G-A (1080p) 50Hz, HD (1080p) 30Hz, and HD (1080p) 29Hz.

The screenshot shows the 'Update' tab selected in the EDID Editor. The interface includes a 'Select Function' bar with 'Discover and Configure IP', 'Manage a Product', and 'EDID Editor' buttons. Below is a 'Select Product' dropdown menu set to 'HDMI/VGA to 3GSDI Scaler, COM9'. A navigation bar contains tabs for 'Adjust', 'System', 'Test Patterns', 'Timings', 'Manage EDID', and 'Update'. The 'Update' tab is active, displaying a 'Product: HDMI/VGA to 3GSDI Scaler' field and an 'Update Method: USB Serial' dropdown. Below these are 'Current Firmware' (1.019) and 'Latest Firmware' (1.019) fields, a 'Check at Startup Enabled' button, and a 'Last Checked: Mon Nov 2 13:45:04 2015' field with a 'Check for Latest Update' button. A text area at the bottom displays release notes for version 1.017 (December 18, 2014) and version 1.019 (July 7, 2015).

- Click the **Start** button to begin downloading the firmware.

The screenshot shows the Syner-G™ Software Suite interface for updating firmware. The main area is titled "Select Function" and contains three buttons: "Discover and Configure IP", "Manage a Product", and "EDID Editor". Below this is a "Select Product" dropdown menu showing "HDMI/VGA to 3GSDI Scaler, COM9". A navigation bar includes tabs for "Adjust", "System", "Test Patterns", "Timings", "Manage EDID", and "Update". The "Manage EDID" tab is active, displaying product information: "Product: HDMI/VGA to 3GSDI Scaler", "Update Method: USB Serial", "Current Firmware: 1.019", "Latest Firmware: 1.019", and "Last Checked: Mon Nov 2 13:45:04 2015". There are buttons for "Check at Startup Enabled" and "Check for Latest Update". The release notes section shows two entries: "Release Notes Version 1.017 --- Decemeber 18, 2014" and "Release Notes Version 1.019 --- July 7, 2015". The "Product Options" section shows "None". The "Download and Install" section features a progress bar at 0%, a "Start" button, and "Install" and "Save" buttons. The "Install from File" section has a "Select File to Upload" field, a "Browse" button, and an "Install" button.

The Syner-G™ Software Suite will automatically download the firmware file for the selected product. This process should take a few seconds.

Once the download process has completed, the progress bar will indicate 100%, as shown on the next page.

A message will also appear at the bottom of the window, indicating that the firmware file was successfully downloaded.

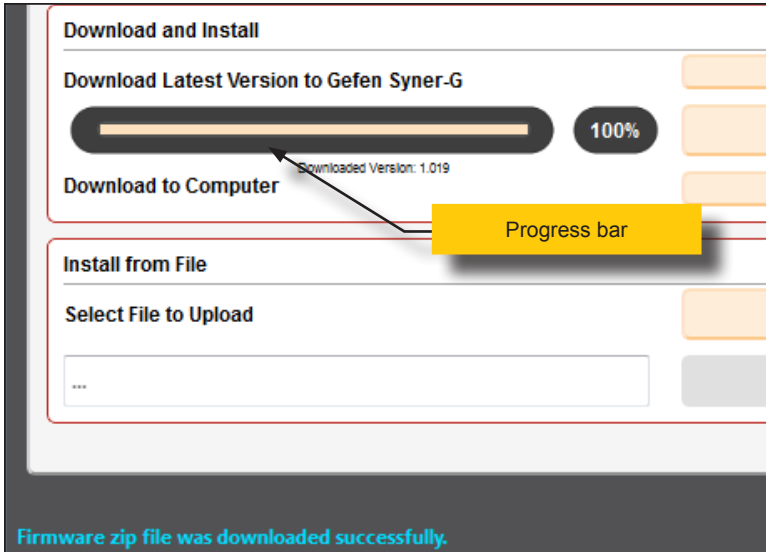

- Click the **Install** button to begin installing the software.

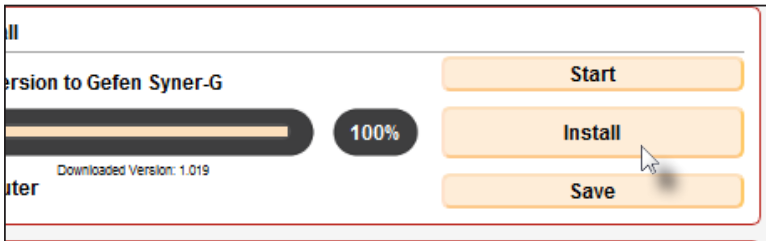

- The installation process will begin and the progress bar will indicate the current status.

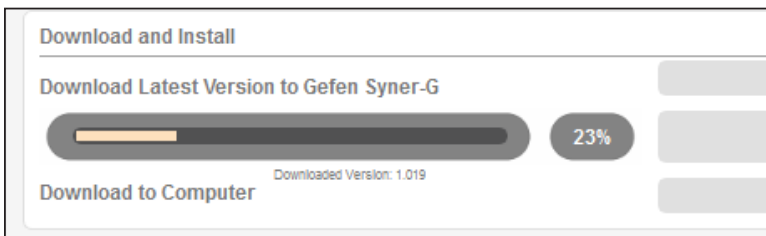

- The firmware update process is completed.

Surface Mounting Instructions

The Sender and Receiver units can be mounted on any flat surface, as shown below (screws not included). There should be an inch or two of clearance between the edges of the unit and any walls or vertical surfaces to allow for enough clearance for connection and disconnection of the video cables.

For installation on a drywall surface, use a #6 drywall screw. When installing, it is recommended to use the center hole on a stud.

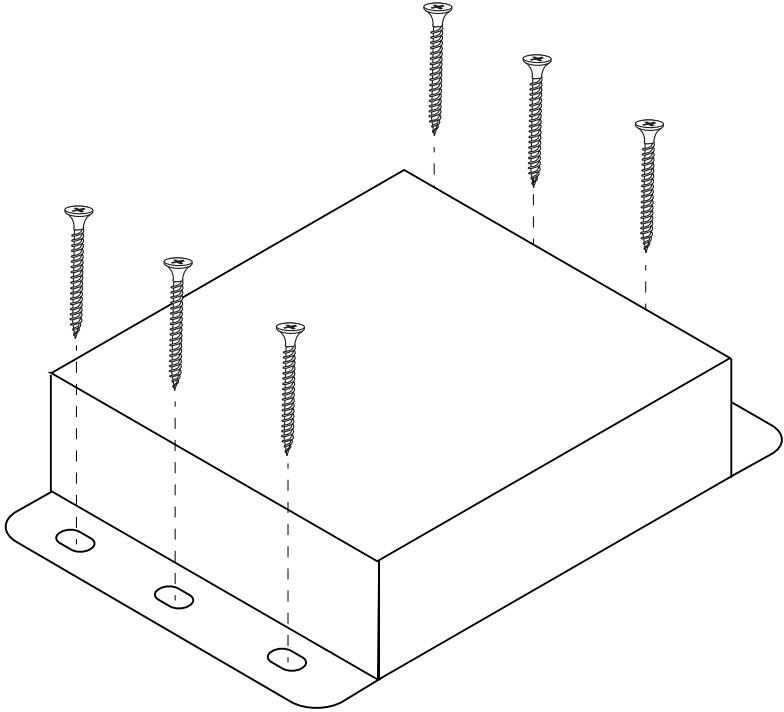

Connectors, Controls, and Indicators

Video Input	• 1 x HDMI Type A, 19-pin, female, locking
Video Input	• 1 x VGA HD-15, female
Video Output	• 1 x SDI, BNC-type, female
Audio	• 1 x 3.5mm mini-stereo
USB	• 1 x USB Mini-B, female
Power Receptacle	• 3-pin, locking
Menu	• 1 x push button, tact-type
HDMI / Up	• 1 x push button, tact-type
VGA / Dn	• 1 x push button, tact-type
Pwr Indicator	• 1 x LED, blue
VGA Indicator	• 1 x LED, green
HDMI Indicator	• 1 x LED, green

Operational

Maximum Pixel Clock	• VGA 165 MHz • HDMI 165 MHz • Output 150 MHz
Maximum TMDS Clock	• 225 MHz
Power Input	• 12V DC (nominal) 6V to 24V DC operating range
Power Consumption	• 5W (max.)
Operating Temperature	• +32 to +122 °F (0 to +50 °C)
Operating Humidity	• 5% to 90% RH, non-condensing
Storage Temperature	• -4 to +185 °F (-20 to +85 °C)
Storage Humidity	• 0% to 95% RH, non-condensing
MTBF	• 50000 Hours

Physical

Dimensions (W x H x D)	• 5.6" x 1.2" x 3.7" (141mm x 30mm x 93mm)
Unit Weight	• 0.5 lbs (0.23 kg)

A

Aspect ratio 28

B

Brightness 20

C

Color

balance 24
saturation 21
temperature 23

COM port

installing 54

Contrast 19

D

Default settings 53

Display notify 37

E

Edge enhance 25

F

Factory reset. *See* Resetting the unit

Features *vi*

Firmware

displaying 40
updating 56

H

Horizontal mirror 29

Horizontal shift 33

Hue 22

I

Input resolution 39

Installation 4

M

Menu system

displaying 9
summary 48
using 10

Mirror

horizontal 29
vertical 31

Mounting Instructions 61

O

Operating Notes *v*

OSD timeout 36

Output

color 15
lock 15
resolution 13

Overscan 27

P

Packing list *vi*

Phase 35

Pixel

active. See Active pixels

Porch

back. See Back porch
front. See Front porch

R

Resolution. *See* Output: resolution
input 39

S

Safety Instructions *ii*

Saturation. *See* Color: saturation

Sharpness 26

Shift

horizontal 33
vertical 34

Specifications 62

T

Table of Contents *viii*

Technical Support *iv*

Test patterns *42*

U

Underscan *27*

Updating the firmware *56*

USB interface *54*

COM port. See COM port: installing

V

Vertical mirror *31*

Vertical shift *34*

Video settings. *See Settings: video*

W

Warranty Information *iii*

This page left intentionally blank.



20600 Nordhoff St., Chatsworth CA 91311
1-800-545-6900 818-772-9100 fax: 818-772-9120
www.gefen.com support@gefen.com